

Float Switch, model FLS...I / 60-...

EN

Schwimmerschalter, Typ FLS...I / 60-...

DE



FLS...I / 60-...

14404458 / 20201125 DE

© 2016 WIKA Alexander Wiegand SE & Co. KG
All rights reserved. / Alle Rechte vorbehalten.
WIKA® and KSR® are registered trademarks in various countries.
WIKA® and KSR® sind geschützte Marken in verschiedenen Ländern.

Prior to starting any work, read the operating instructions!
Keep for later use!

Vor Beginn aller Arbeiten Betriebsanleitung lesen!
Zum späteren Gebrauch aufbewahren!



KSR Kuebler Niveau-Messtechnik GmbH
Heinrich-Kuebler-Platz 1
69439 Zwingenberg am Neckar • Germany
Tel. +49 6263/87-0
Fax +49 6263/87-99
info@ksr-kuebler.com
www.ksr-kuebler.com

Inhalt

Deutsch.....	6
1. Allgemeines	6
2. Aufbau und Funktion	7
2.1 Funktionsbeschreibungen.....	7
2.2 Lieferumfang	8
3. Sicherheit.....	8
3.1 Symbolerklärung.....	8
3.2 Bestimmungsgemäße Verwendung	9
3.3 Fehlgebrauch	11
3.4 Verantwortung des Betreibers	11
3.5 Personalqualifikation	12
3.6 Persönliche Schutzausrüstung	12
3.7 Beschilderung, Sicherheitskennzeichnung.....	13
4. Transport, Verpackung und Lagerung	14
4.1 Transport.....	14
4.2 Verpackung und Lagerung	14
5. Inbetriebnahme, Betrieb	15
5.1 Funktionsprüfung.....	15
5.2 Montage	16
5.3 Elektrischer Anschluss.....	18
5.4 Inbetriebnahme.....	23
6. Störungen	24
7. Wartung und Reinigung.....	25
7.1 Wartung.....	25
7.2 Reinigung	26
8. Demontage, Rücksendung und Entsorgung.....	27
8.1 Demontage.....	27

8.2	Rücksendung	27
8.3	Entsorgung	27
9.	Technische Daten	28
9.1	Kennzeichnung.....	28
9.2	Elektrische Daten	28
9.3	Temperaturangaben	29
English	33
1.	General	33
2.	Layout and Function.....	34
2.1	Functional descriptions	34
2.2	Delivery contents	35
3.	Safety.....	35
3.1	Symbol legend.....	35
3.2	Intended use.....	36
3.3	Improper use	38
3.4	Owner's responsibility.....	38
3.5	Personnel qualifications.....	39
3.6	Personal protective equipment	39
3.7	Labelling, Safety labelling	40
4.	Transport, packaging and storage.....	41
4.1	Transport.....	41
4.2	Packaging and storage	41
5.	Commissioning, Operation	42
5.1	Functional test	42
5.2	Assembly.....	43
5.3	Electrical connection.....	45
5.4	Commissioning	50
6.	Faults	51
7.	Maintenance and cleaning	52

7.1 Maintenance.....	52
7.2 Cleaning.....	53
8. Dismantling, returns and disposal	54
8.1 Dismantling.....	54
8.2 Returns.....	54
8.3 Disposal.....	54
9. Technical data.....	55
9.1 Marking	55
9.2 Electrical data.....	55
9.3 Temperatures	56
10 Appendix / Anhang.....	60

Deutsch

1. Allgemeines

- Die in der Betriebsanleitung beschriebenen Schwimmerschalter werden nach dem aktuellen Stand der Technik konstruiert und gefertigt. Alle Komponenten unterliegen während der Fertigung strengen Qualitäts- und Umweltkriterien. Unsere Managementsysteme sind nach ISO 9001 zertifiziert.
- Diese Betriebsanleitung gibt wichtige Hinweise zum Umgang mit dem Gerät. Voraussetzung für sicheres Arbeiten ist die Einhaltung aller angegebenen Sicherheitshinweise und Handlungsanweisungen.
- Die für den Einsatzbereich des Gerätes geltenden örtlichen Unfallverhütungsvorschriften und allgemeinen Sicherheitsbestimmungen einhalten.
- Die Betriebsanleitung ist Produktbestandteil und muss in unmittelbarer Nähe des Gerätes für das Fachpersonal jederzeit zugänglich aufbewahrt werden. Betriebsanleitung an nachfolgende Benutzer oder Besitzer des Gerätes weitergeben.
- Das Fachpersonal muss die Betriebsanleitung vor Beginn aller Arbeiten sorgfältig durchgelesen und verstanden haben.
- Es gelten die allgemeinen Geschäftsbedingungen in den Verkaufsunterlagen.
- Technische Änderungen vorbehalten.
- Weitere Informationen:
 - Internet-Adresse: www.ksr-kuebler.com oder www.wika.de

Abkürzungen, Definitionen

L-SP	Niveau-Schaltpunkt
T-SP	Temperatur-Schaltpunkt
NO/NC	Schließer/Öffner
CO	Umschalter

2. Aufbau und Funktion

2.1 Funktionsbeschreibungen

Schwimmerschalter arbeiten nach dem Schwimmerprinzip mit magnetischer Übertragung. Ein im Gleitrohr eingebauter Reedkontakt wird durch das Magnetfeld eines Permanentmagneten bei Erreichen eines vorgegebenen Schaltpunktes betätigt. Der Permanentmagnet befindet sich in einem Schwimmer, der seine Höhenlage mit dem Flüssigkeitspegel des zu überwachenden Messstoffes verändert. Der Schaltzustand des Reedkontaktes kann durch eine nachgeschaltete Steuereinrichtung ausgewertet und weiterverarbeitet werden.

Die Anzahl und Anordnung der Schwimmer ist abhängig von der Anzahl der vorgegebenen Schaltpunkte, deren Kontaktfunktion sowie dem Abstand der Schaltpunkte.

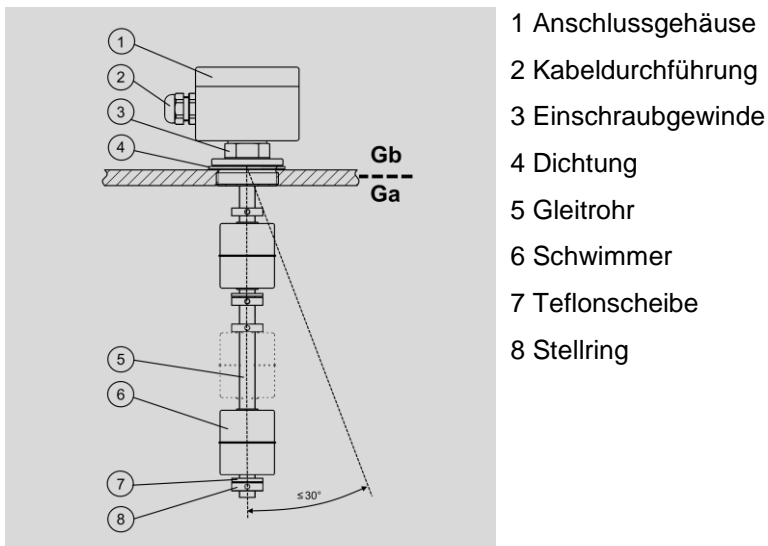

- 1 Anschlussgehäuse
- 2 Kabeldurchführung
- 3 Einschraubgewinde
- 4 Dichtung
- 5 Gleitrohr
- 6 Schwimmer
- 7 Teflonscheibe
- 8 Stelling

Schwimmerschalter FLS...I und 60... sind für die Verwendung in Ex-Zonen zugelassen.

Typ	Schutzart	Verwendung in Ex-Zone	EU-Baumusterprüfbescheinigung
FLS...I / 60-...	Ex i (eigensicher)	Zone 0/1, 1 und 2	KEMA 01 ATEX 1053 X

2.2 Lieferumfang

Lieferumfang mit dem Lieferschein abgleichen.

3. Sicherheit

3.1 Symbolerklärung



GEFAHR!

... weist auf eine unmittelbar gefährliche Situation hin, die zum Tod oder zu schweren Verletzungen führt, wenn sie nicht gemieden wird.



WARNUNG!

... weist auf eine möglicherweise gefährliche Situation hin, die zum Tod oder zu schweren Verletzungen führen kann, wenn sie nicht gemieden wird.



VORSICHT!

... weist auf eine möglicherweise gefährliche Situation hin, die zu geringfügigen oder leichten Verletzungen bzw. Sach- und Umweltschäden führen kann, wenn sie nicht gemieden wird.



Information

... hebt nützliche Tipps und Empfehlungen sowie Informationen für einen effizienten und störungsfreien Betrieb hervor.



Hinweis für Ex-Geräte

... hebt die relevanten und/oder benötigten Informationen hervor, die zum Betrieb in explosionsgefährdeten Bereichen notwendig sind.

3.2 Bestimmungsgemäße Verwendung

Die Schwimmerschalter dienen ausschließlich der Füllstandüberwachung von flüssigen Medien. Der Einsatzbereich ergibt sich aus den technischen Leistungsgrenzen und Werkstoffen.

- Die Flüssigkeiten dürfen keine starken Verschmutzungen oder Grobteile aufweisen und nicht zum Auskristallisieren neigen. Es ist sicherzustellen, dass die medienberührenden Werkstoffe des Schwimmerschalters gegen den zu überwachenden Messstoff ausreichend beständig sind. Nicht geeignet für Dispersionen, abrasive Flüssigkeiten, hochviskose Medien und Farben.
- Die in der Betriebsanleitung angegebenen Einsatzbedingungen sind einzuhalten.
- Gerät nicht in unmittelbarer Nähe von ferromagnetischer Umgebung (Abstand min. 50 mm) betreiben.
- Gerät nicht in unmittelbarer Nähe von starken elektromagnetischen Feldern bzw. in unmittelbarer Nähe von Einrichtungen betreiben, die durch Magnetfelder beeinflusst werden können (Abstand min. 1 m).
- Die Schwimmerschalter dürfen keinen starken mechanischen Belastungen (Stoß, Verbiegen, Vibrationen) ausgesetzt werden.
- Die technischen Spezifikationen in dieser Betriebsanleitung sind einzuhalten. Eine unsachgemäße Handhabung oder ein Betreiben des Gerätes außerhalb der technischen Spezifikationen macht die sofortige Stilllegung und Überprüfung durch einen autorisierten WIKA-Servicemitarbeiter erforderlich.

Zulassung KEMA 01 ATEX 1053 X	
FLS...I / 60...	II 1/2 G Ex ia IIC T6...T1 Ga/Gb II 2 D Ex ib IIIC T80°C...T230°C Db
FLS-XKSI	II 1/2 G Ex ia IIC T4...T1 Ga/Gb
Sonderausführung ohne Fallschutz	
FLS...I / 60...	II 1/2 G Ex ia IIB T6...T1 Ga/Gb II 2 D Ex ib IIIC T80°C...T230°C Db
FLS-XKSI	II 1/2 G Ex ia IIB T4...T1 Ga/Gb
Schwimmer und Gleitrohr in Zone 0	



Hinweis für Ex-Geräte

Die Schwimmerschalter 60-... sind als explosionsgeschützte Betriebsmittel innerhalb des Geltungsbereiches der EG Richtlinie 2014/34/EU, für den Einsatz in explosionsgefährdeten Bereichen zugelassen. Sie erfüllen die Anforderungen an elektrische Betriebsmittel für explosionsgefährdete Bereiche.

Die technischen Daten in dieser Betriebsanleitung sind zu beachten.

Das Gerät ist ausschließlich für den hier beschriebenen bestimmungsgemäßen Verwendungszweck konzipiert und konstruiert und darf nur dementsprechend verwendet werden.

Ansprüche jeglicher Art aufgrund von nicht bestimmungsgemäßer Verwendung sind ausgeschlossen.



GEFAHR!

Beim Arbeiten an Behältern, besteht Vergiftungs- oder Erstickungsgefahr. Arbeiten dürfen nur unter Anwendung geeigneter Personenschutzmaßnahmen (z. B. Atemschutzgerät, Schutzkleidung o. Ä.) durchgeführt werden.



Hinweis für Ex-Geräte

Achtung Explosionsgefahr!

Am Behälter besteht die Gefahr explosionsfähiger Atmosphäre. Es sind entsprechende Maßnahmen, die eine Funkenbildung verhindern, zu ergreifen. Arbeiten in diesem Bereich dürfen nur durch Fachpersonal entsprechend den jeweiligen geltenden Sicherheitsrichtlinien durchgeführt werden.

3.3 Fehlgebrauch

Als Fehlgebrauch gilt jede Verwendung, die die technischen Leistungsgrenzen überschreitet oder mit den Werkstoffen unverträglich ist.



WARNUNG!

Verletzungen durch Fehlgebrauch

Fehlgebrauch des Gerätes kann zu gefährlichen Situationen und Verletzungen führen.

Eigenmächtige Umbauten am Gerät sind zu unterlassen.

Jede über die bestimmungsgemäße Verwendung hinausgehende oder andersartige Benutzung gilt als Fehlgebrauch.

Dieses Gerät nicht in Sicherheits- oder in Not-Aus-Einrichtungen benutzen.

3.4 Verantwortung des Betreibers

Das Gerät wird im gewerblichen Bereich eingesetzt. Der Betreiber unterliegt daher den gesetzlichen Pflichten zur Arbeitssicherheit.

Die Sicherheitshinweise dieser Betriebsanleitung, sowie die für den Einsatzbereich des Gerätes gültigen Sicherheits-, Unfallverhütungs- und Umweltschutzvorschriften einhalten.

Für ein sicheres Arbeiten am Gerät muss der Betreiber Folgendes sicherstellen:

- Bedienpersonal wird regelmäßig in allen zutreffenden Fragen von Arbeitssicherheit, Erste Hilfe und Umweltschutz unterwiesen.
- Bedienpersonal hat Betriebsanleitung gelesen und insbesondere die darin enthaltenen Sicherheitshinweise zur Kenntnis genommen.
- Die bestimmungsgemäße Verwendung für den Anwendungsfall wird eingehalten.

3.5 Personalqualifikation



WARNUNG!

Verletzungsgefahr durch unzureichende Qualifikation
Unsachgemäßer Umgang kann zu erheblichen Personen- und Sachschäden führen.

- Die in dieser Betriebsanleitung beschriebenen Tätigkeiten nur durch Fachpersonal nachfolgend beschriebener Qualifikationen durchführen lassen.

Fachpersonal

Das vom Betreiber autorisierte Fachpersonal ist aufgrund seiner fachlichen Ausbildung, seiner Kenntnisse der Mess- und Regelungstechnik und seiner Erfahrungen sowie Kenntnis der landesspezifischen Vorschriften, geltenden Normen und Richtlinien in der Lage, die beschriebenen Arbeiten auszuführen und mögliche Gefahren selbständig zu erkennen.

3.6 Persönliche Schutzausrüstung

Die persönliche Schutzausrüstung dient dazu, das Fachpersonal gegen Gefahren zu schützen, die dessen Sicherheit oder Gesundheit bei der Arbeit beeinträchtigen könnten. Beim Ausführen der verschiedenen Arbeiten an und mit dem Gerät muss das Fachpersonal persönliche Schutzausrüstung tragen.

Im Arbeitsbereich angebrachte Hinweise zur persönlichen Schutzausrüstung befolgen!

Die erforderliche persönliche Schutzausrüstung muss vom Betreiber zur Verfügung gestellt werden.

3.7 Beschilderung, Sicherheitskennzeichnung

Typenschild (Beispiele)

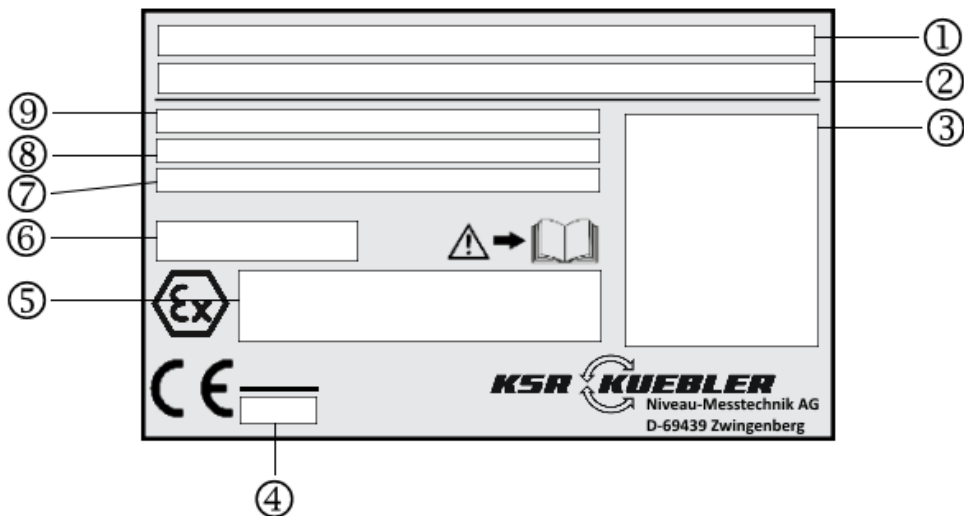

- 1 - Typ, Bezeichnung
- 2 - Gerätecodierung
- 3 - L1 ... Ln: Schaltpunktangabe in mm
- 4 - Notifizierte Stelle nach EU-Richtlinie 2014/34/EU
- 5 – Zertifikatsnummer und Ex-Kennzeichnung
- 6 - Schutzart nach IEC/EN 60529 und Umgebungstemperaturbereich
- 7 - Artikelnummer, Seriennummer, Messstellenummer
- 8 - Auslegungsdruck PS, Prüfdruck PT, Auslegungstemperatur TS
- 9 - Elektrische Daten

Symbole



Vor Montage und Inbetriebnahme des Gerätes unbedingt die Betriebsanleitung lesen und die besonderen Bedingungen des Ex-Zertifikates beachten!

4. Transport, Verpackung und Lagerung

4.1 Transport

Schwimmerschalter auf eventuell vorhandene Transportschäden untersuchen. Offensichtliche Schäden unverzüglich mitteilen.



VORSICHT!

Beschädigung durch unsachgemäßen Transport

Bei unsachgemäßem Transport können Sachschäden in erheblicher Höhe entstehen.

- Symbole auf der Verpackung beachten
- Packstücke vorsichtig behandeln

4.2 Verpackung und Lagerung

Verpackung erst unmittelbar vor der Inbetriebnahme entfernen.

5. Inbetriebnahme, Betrieb

- Alle auf der Versandverpackung angegebenen Hinweise zum Entfernen der Transportsicherungen beachten.
- Den Schwimmerschalter vorsichtig aus der Verpackung entnehmen!
- Beim Auspacken alle Teile auf äußerliche Beschädigungen überprüfen.
- Funktionsprüfung vor dem Einbau durchführen

5.1 Funktionsprüfung



Funktionsprüfung

Vor der Montage kann der Schwimmerschalter wie unter Kapitel 5.3 beschrieben angeschlossen und die Schaltpunkte manuell betätigt werden.



WARNUNG!

Sicherstellen, dass die Funktionsprüfung keine unbeabsichtigten Prozesse startet.



Hinweis für Ex-Geräte

Zur Funktionsprüfung sind Prüfmittel zu verwenden, die für den Einsatz im explosionsgefährdeten Bereich geeignet bzw. zugelassen sind. Diese Tätigkeiten dürfen nur von sachkundigem Personal durchgeführt werden.



Hinweis für Ex-Geräte

Schwimmerschalter der Serie FLS...I oder 60... Zündschutzart Ex i dürfen im Ex-Bereich der Zone 0/1 (Schwimmer und Gleitrohr in Zone 0) nur an bescheinigte eigensichere Steuerstromkreise angeschlossen werden. Die maximalen Betriebsdaten sind dabei zu beachten.

Geräte mit Pulverbeschichtung, Kunststoffen oder Typschilder aus Kunststoffen auf metallischen Gehäuse, dürfen nicht in Bereichen eingesetzt werden, in denen stark ladungserzeugende Prozesse, maschinelle Reib bzw. Trennprozesse, das sprühen von Elektronen, z.B. im Umfeld von elektrostatischen Lackiereinrichtungen, stattfindet oder pneumatisch geförderter Staub austritt.

Potentialausgleich

Das Gerät muss in den Potenzialausgleich der Anlage eingebunden werden.

Chemische Reaktionen bzw. Selbstentzündungsvorgänge können nur vom Medium selbst ausgehen, nicht vom Gerät. Die Zündgefahren des Mediums selbst, müssen vom Betreiber berücksichtigt und verhindert werden.

Hohe oder niedrige Temperaturen und/oder hohe Drücke im Innern des Behälters beeinflussen die sicherheitstechnischen Kenngrößen der auftretenden Stoffe. Wenn im Innern des Behälters Drücke oder Temperaturen im nichtatmosphärischen Bereich auftreten, dann muss der Betreiber selbst prüfen, welche Einflüsse diese Bedingungen auf die sicherheitstechnischen Kenngrößen der auftretenden Stoffe haben und welche direkten Zündgefahren daraus resultieren

5.2 Montage

- Die im Rohrleitungsbau vorgeschriebenen Drehmomentwerte der Schrauben einhalten.
- Bei der Auswahl des Montagematerials (Dichtungen, Schrauben, Unterlegscheiben und Muttern) die Prozessbedingungen beachten. Die Eignung der Dichtung muss hinsichtlich Messstoff und dessen Dämpfen gegeben sein. Zusätzlich ist auf entsprechende Korrosionsbeständigkeit zu achten.

- Schwimmerschalter entweder über Einschraubgewinde (3) oder Montageflansch (nicht dargestellt) einbauen.
- Das Gleitrohr (5) darf maximal 30° zur Vertikalen geneigt sein.
- Die Anzahl der Schwimmer sowie die Position der Schwimmeranschläge sind vom Maß und der Anzahl der Schaltpunkte abhängig.

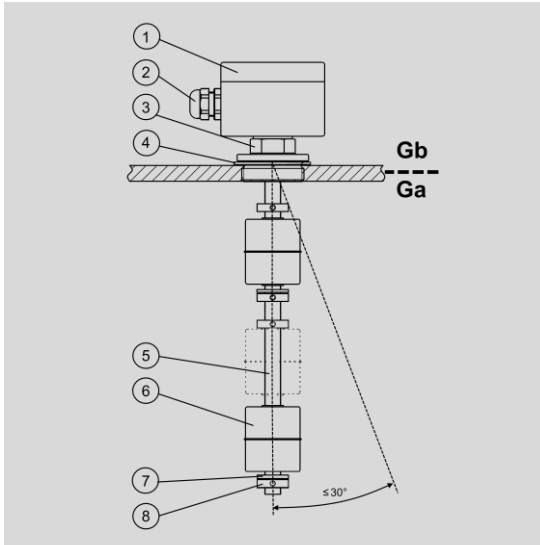

- 1 Anschlussgehäuse
- 2 Kabeldurchführung
- 3 Einschraubgewinde
- 4 Dichtung
- 5 Gleitrohr
- 6 Schwimmer
- 7 Teflonscheibe
- 8 Stelling



Hinweis für Ex-Geräte

Eine Teflonscheibe auf den Schwimmeranschlägen verhindert die Funkenbildung, wenn der Schwimmer auf sie fällt. Die Verwendung des Gerätes ohne diese Teflonscheibe ist nicht gestattet.*

*Ausgenommen, KSR Sondervarianten für Gasgruppe **IIB** ohne Teflonscheibe

In Behältern, bei denen mit dem Auftreten von Turbulenzen zu rechnen ist, sind Schwimmerschalter mit einer Länge über 3000mm zusätzlich gegen Verbiegen des Gleitrohres zu sichern. Dies kann z.B. durch eine Aufnahmhülse am Behälterboden erfolgen.

Wenn Schwimmer aus Titan verwendet werden, ist darauf zu achten, dass diese Schwimmer auch in seltenen Fällen, keine Reib- und Schlagfunken erzeugen können.

5.3 Elektrischer Anschluss

- Der elektrische Anschluss darf nur durch qualifiziertes Fachpersonal erfolgen.
- Die Belegung der Anschlüsse und die Schaltfunktionen sind auf dem Anschlussschema am Gerät angegeben und die Anschlussklemmen sind entsprechend gekennzeichnet (Ausnahme: Ausführungen mit nur einem Öffner- oder Schließerkontakt).
- Die Kabeldurchführung am Anschlussgehäuse abdichten. Um die IP-Schutzart zu erhalten, geeignete Kabelverschraubungen verwenden.



WARNUNG!

Fehler beim elektrischen Anschluss von Schwimmerschaltern können die Reedkontakte zerstören. Dies kann zu einer Fehlfunktion der Anlage und dadurch zu Personen- oder Sachschäden führen.

- Kein direkter Betrieb an Schaltungen mit induktiver Last.
- Kein direkter Betrieb an Schaltungen mit kapazitiver Last, z. B. SPS, PLS oder Leitungslängen > 50 m.
- Kein Überschreiten der zulässigen Schaltleistung.



Hinweis für Ex-Geräte Ex i

Schwimmerschalter der Serie FLS...I oder 60... Zündschutzart Ex i dürfen im Ex-Bereich der Zone 0/1 (Schwimmer und Gleitrohr in Zone 0) nur an bescheinigte eigensichere Steuerstromkreise (ia) angeschlossen werden. Die elektrischen Daten auf dem Typschild sind zu beachten.

Die nationalen Vorschriften zum Errichten eigensicherer Steuerstromkreise sind zu beachten. (s. 9.1 Schaltleistungen /Elektrische Werte)

Die innere Kapazität und Induktivität des verwendeten Kabels sind bezüglich des nachgeschalteten eigensicheren Steuergerätes zu beachten.

Die Arbeiten dürfen nur von geschultem Fachpersonal vorgenommen werden.

Es dürfen nur Kabel- bzw. Leitungseinführungen und Verschlussstopfen mit einer EG Baumusterprüfbescheinigung nach EN 60079-0 und für Ex i Geräte nach EN 60079-7 (Ex e) eingesetzt werden.

Diese müssen mindestens für den gleichen Temperaturbereich und IP Schutz bescheinigt sein, wie der Schwimmerschalter. Es ist weiterhin zu beachten, dass die Gewindegröße und Gewindeausführung der jeweiligen Geräteausführung des Gehäuses entspricht und die Verschraubung für das verwendete Anschlusskabel geeignet ist. Die Verwendung einzelner Litzen ist nicht zulässig! Bei nicht beachten erlischt die Bauartzulassung.

Nichtbenutzte Öffnungen für Leitungseinführungen sind mit zugelassenen Verschlussstopfen, Ex e IIC für die Ex i Variante, dauerhaft zu verschließen.

Zur Inbetriebnahme von Zubehör unbedingt die jeweilige Montage- und Betriebsanleitung beachten.

Die elektrischen Daten auf dem Typschild sind zu beachten. Der Anschluss ist gemäß Anschlussschema entsprechend der gewünschten Schaltfunktion durchzuführen. Beachten Sie bei der Auswahl des Kabels, dass es für den vorgesehenen Anwendungsbereich (Temperatur, Witterungseinflüsse, aggressive Atmosphäre usw.) und für die verwendete Kabelverschraubung geeignet ist.



Anschließen des Kabels

Das Anschlusskabel ist gemäß den geltenden Vorschriften zum Errichten von Stromkreise zu verlegen

Stromkreis spannungslos schalten

Deckel des Klemmgehäuse entfernen

Kabel durch die Kabelverschraubung in das Klemmgehäuse einführen

Den Mantel abisolieren.

Achtung! durch die Kabelverschraubung dürfen keine Einzellitzen geführt werden. Es ist immer sicherzustellen, dass das Kabel zur verwendeten Kabelverschraubung passt und der Kabelmantel sicher in der Kabelverschraubung geklemmt wird.

Die Litzen abisolieren und mit Aderendhülsen versehen

Die Adern entsprechend den jeweiligen Vorgaben in die Klemmen einstecken und befestigen

Gehäusedeckel aufsetzen und befestigen.

Das jeweilige Anschlussschema ist zu beachten



Potentialausgleich













































































Bei Schwimmerschalter mit Anschlussgehäuse steht mindestens eine Anschlussklemme für den Potentialausgleich im oder außen am Gehäuse zur Verfügung.









































Bei Schwimmerschalter mit Kabel muss der Betreiber den Schwimmerschalter in die Erdung des Tankes, Einbauefäßes oder sonstige Einbau oder Anbausituation einbeziehen.

Beachten Sie die Erdungszeichen im oder am Gehäuse.

Anschlussbilder

Farb-Kurzzeichen

Anzahl Schaltpunkte	PVC Kabel		Silikonkabel		Anschlussgehäuse	
	NO/NC	CO	NO/NC	CO	NO/NC	CO
1 L-SP	WH  L1 BN 	WH  L1 BN  L1 GN 	X*  L1 BN 		1  L1 2 	1  L1 2  L1 3 
2 L-SP	WH  L1 BN  GN  L2 YE 	WH  L1 BN  L1 GN  YE  L2 PK  L2 GY 	WH  L1 BN  GN  L2 YE 		1  L1 2  3  L2 4 	1  L1 2  L1 3  4  L2 5  L2 6 
3 L-SP	WH  L1 BN  GN  L2 YE  PK  L3 GR 				1  L1 2  3  L2 4  5  L3 6 	1  L1 2  3  4  L2 5  L2 6  7  L3 8  L3 9 
4 L-SP					1  L1 2  3  L2 4  5  L3 6  7  L4 8 	1  L1 2  3  4  L2 5  L2 6  7  L3 8  L3 9  10  L4 11  L4 12 

Anzahl Schaltpunkte	PVC Kabel		Silikonkabel		Anschlussgehäuse	
	NO/NC	CO (L-SP)	NO/NC	CO	NO/NC	CO
1 L-SP und 1 T-SP	WH  L1 BN  GN  9 YE 	WH  L1 BN  L1 GN  YE  9 PK	WH  L1 BN  GN  9 YE 		1  L1 2  3  9 4 	1  L1 2  L1 3  4  9 5  9
2 L-SP und 2 T-SP	WH  L1 BN  GN  9, YE  PK  9, GY				1  L1 2  3  9, 4  5  9, 6  7 	1  L1 2  L1 3  4  9, 5  9, 6  9, 7  9,

Pin-Belegung Stecker

Anzahl Schaltpunkte	ASHBB / ASHBA					
	NO/NC	CO	NO/NC	CO	NO/NC	CO
1 L-SP	1  L1 2 	1  L1 2  L1 3 				
2 L-SP	1  L1 2  3  L2 4 	1  L1 2  L1 3  4  L2 5  L2 6 				
3 L-SP	1  L1 2  3  L2 4  5  L3 6 					

Beachten Sie bitte die Anschlussbilder auf dem Gerät. Diese können zu den hier aufgeführten Beispielen abweichen.



Warnung!

Der Betrieb der Magnetschalter an induktiver oder kapazitiver Last kann eine Zerstörung des Reedkontaktes zur Folge haben. Dies kann zu einer Fehlfunktion der nachgeschalteten Steuerung und zu Personen- oder Sachschäden führen.

Bei kapazitiver Belastung, Leitungslängen über 50m oder dem Anschluss an Prozessleitsystemen mit kapazitivem Eingang ist zur Begrenzung des Spitzenstromes ein Schutzwiderstand von 22Ω in Serie zu schalten.

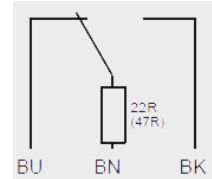

5.4 Inbetriebnahme

Spannungsversorgung der angeschlossenen Steuerungseinrichtung einschalten. Behälter füllen und die Schaltpunkte des Schwimmerschalters auf Funktion prüfen.



WARNUNG!

Sicherstellen, dass die Funktionsprüfung keine unbeabsichtigten Prozesse startet.

Zur Inbetriebnahme von Zubehör unbedingt die jeweilige Montage- und Betriebsanleitung beachten.

6. Störungen



In der folgenden Tabelle sind die häufigsten Fehlerursachen und die erforderlichen Gegenmaßnahmen aufgeführt.

Störung	Ursache	Maßnahme
Schwimmerschalter lässt sich nicht an der vorgesehenen Stelle am Behälter anbauen	Prozessanschluss des Schwimmerschalters passt nicht zu dem Prozessanschluss des Behälters.	Umbau des Behälters Rücksendung ans Werk
	Prozessanschluss am Behälter defekt	Nacharbeiten des Gewindes oder Austauschen der Befestigungsmuffe
	Einschraubgewinde am Schwimmerschalter defekt	Rücksendung ans Werk
Keine oder undefinierte Schaltfunktion	Elektrischer Anschluss falsch	Siehe Kapitel 5.3 „Elektrischer Anschluss“. Belegung mit Hilfe des Anschlussbildes prüfen.
	Temperaturkontakt defekt	Rücksendung ans Werk
	Reed-Kontakt defekt	Rücksendung ans Werk



VORSICHT!

Körperverletzungen, Sach- und Umweltschäden

Können Störungen mit Hilfe der aufgeführten Maßnahmen nicht beseitigt werden, Gerät unverzüglich außer Betrieb setzen.

- Sicherstellen, dass kein Druck mehr anliegt und gegen versehentliche Inbetriebnahme schützen.
- Kontakt mit dem Hersteller aufnehmen.
- Bei notwendiger Rücksendung die Hinweise unter Kapitel 8.2 „Rücksendung“ beachten.

7. Wartung und Reinigung

7.1 Wartung

Schwimmerschalter arbeiten bei bestimmungsgemäßen Gebrauch wartungs- und verschleißfrei. Sie sind jedoch im Rahmen der regelmäßigen Wartung einer Sichtkontrolle zu unterziehen und in die Druckprüfung des Behälters mit einzubeziehen.



GEFAHR!

Beim Arbeiten an Behältern, besteht Vergiftungs- oder Erstickungsgefahr. Arbeiten dürfen nur unter Anwendung geeigneter Personenschutzmaßnahmen (z.B. Atemschutz gerät, Schutzkleidung o.Ä.). durchgeführt werden.

Reparaturen sind ausschließlich vom Hersteller durchzuführen.



HINWEIS!

Eine einwandfreie Funktion des Schwimmerschalters kann nur bei Verwendung von KSR Kuebler Zubehör und Ersatzteilen garantiert werden

7.2 Reinigung



VORSICHT!

Körperverletzungen, Sach- und Umweltschäden

Eine unsachgemäße Reinigung führt zu Körperverletzungen, Sach- und Umweltschäden. Messstoffreste im ausgebauten Gerät können zur Gefährdung von Personen, Umwelt und Einrichtung führen.

- Ausgebautes Gerät spülen bzw. säubern.
 - Ausreichende Vorsichtsmaßnahmen sind zu ergreifen.
1. Vor der Reinigung das Gerät ordnungsgemäß vom Prozess und der Stromversorgung trennen.
 2. Das Gerät vorsichtig mit einem feuchten Tuch reinigen.
 3. Elektrische Anschlüsse nicht mit Feuchtigkeit in Berührung bringen!



VORSICHT!

Sachbeschädigung

Eine unsachgemäße Reinigung führt zur Beschädigung des Gerätes!

- Keine aggressiven Reinigungsmittel verwenden.
- Keine harten und spitzen Gegenstände zur Reinigung verwenden.

8. Demontage, Rücksendung und Entsorgung



WARNUNG!

Körperverletzung, Sach- und Umweltschäden durch Messstoffreste

Messstoffreste im ausgebauten Gerät können zur Gefährdung von Personen, Umwelt und Einrichtung führen.

- Ausgebautes Gerät spülen bzw. säubern, um Personen und Umwelt vor Gefährdung durch anhaftende Messstoffreste zu schützen.

8.1 Demontage

Messgerät nur im drucklosen und spannungsfreiem Zustand demontieren! Gegebenenfalls muss der Behälter entspannt werden.

8.2 Rücksendung

Ausgebauten Schwimmerschalter vor der Rücksendung spülen bzw. säubern, um Mitarbeiter und Umwelt vor Gefährdung durch anhaftende Messstoffreste zu schützen.



Hinweise zur Rücksendung befinden sich in der Rubrik „Service“ auf unserer lokalen Internetseite.

8.3 Entsorgung

Durch falsche Entsorgung können Gefahren für die Umwelt entstehen. Gerätekomponenten und Verpackungsmaterialien entsprechend den landesspezifischen Abfallbehandlungs- und Entsorgungsvorschriften umweltgerecht entsorgen.

9. Technische Daten

9.1 Kennzeichnung

Typ	Zulassung KEMA 01 ATEX 1053 X
FLS...I / 60...	II 1/2 G Ex ia IIC T6...T1 Ga/Gb II 2 D Ex ib IIIC T80°C...T230°C Db
FLS-XKSI	II 1/2 G Ex ia IIC T4...T1 Ga/Gb
Sonderausführung ohne Fallschutz	
FLS...I / 60...	II 1/2 G Ex ia IIB T6...T1 Ga/Gb II 2 D Ex ib IIIC T80°C...T230°C Db
FLS-XKSI	II 1/2 G Ex ia IIB T4...T1 Ga/Gb
	Schwimmer und Gleitrohr in Zone 0

9.2 Elektrische Daten

Typ	Schließer, Öffner, Umschalter
FLS...I 60-...	Ex ia $U_i \leq 36 \text{ V}$, $I_i \leq 100 \text{ mA}$, $P_i \leq 0,84\text{W}$, $C_i = 0 \text{ nF}$, $L_i = 0 \text{ mH}$
FLS...NI 60... (Namur)	Ex ia $U_i \leq 18,5 \text{ V}$, $I_i \leq 30 \text{ mA}$, $P_i \leq 0,4\text{W}$, $C_i = 0 \text{ nF}$, $L_i = 0 \text{ mH}$
FLS...RI 60... (Rv)	Ex ia $U_i \leq 36 \text{ V}$, $I_i \leq 100 \text{ mA}$, $P_i \leq 0,84\text{W}$, $C_i = 0 \text{ nF}$, $L_i = 0 \text{ mH}$
Nur zum Anschluss an einen bescheinigten eigensicheren Ex ia Stromkreis	
Optionaler Stromkreis für ein (oder eine Kombination von) PT100, PT1000, Temperaturschalter in Zündschutzart Eigensicherheit Ex ia	
	$U_i \leq 30 \text{ V}$; $I_i \leq 120\text{mA}$, $P_i \leq 0,9 \text{ W}$, $C_i = 0 \text{ nF}$; $L_i = 0 \text{ mH}$
Namur	$U_i \leq 18,5 \text{ V}$, $I_i \leq 30 \text{ mA}$, $P_i \leq 0,4\text{W}$, $C_i = 0 \text{ nF}$; $L_i = 0 \text{ mH}$
Falls ein optionaler ATEX Kopfmessumformer verwendet wird, z.B. Zusatzoption PT100 mit Kopfmessumformer, sind die elektrischen Daten auf dem entsprechenden KSR Typschild gültig.	
Nur zum Anschluss an einen bescheinigten eigensicheren Stromkreis	

9.3 Temperaturangaben



Hinweis für Ex-Geräte FLS...I Temperatur FLS...I

Temperaturklasse	zulässige Umgebungstemperatur (Ta)*	Prozesstemperatur FLS...I	Prozesstemperatur FLS...I - Kontakt mit Widerstandsbeschaltung	Oberflächentemperatur (EPL Db)
T1	-50*1...+80°C	≤ 200°C	≤ 200°C	≤ 230°C
T2	-50*1 ...+80°C	≤ 200°C	≤ 200°C	≤ 230°C
T3	-50*1...+80°C	≤ 195°C	≤ 165°C	≤ 195°C
T4	-50*1...+80°C	≤ 130°C	≤ 100°C	≤ 130°C
T5	-50*1...+65°C	≤ 95°C	≤ 65°C	≤ 95°C
T6	-50*1...+50°C	≤ 80°C	≤ 50°C	≤ 80°C

*Umgebungstemperatur ist die Temperatur am Anschlussgehäuse, Anschlusskabel oder Anschlussstecker

*1 Die minimale Umgebungstemperatur kann je nach Ausführung eingeschränkt sein. Die für ihr Gerät zugelassene Umgebungstemperatur (Ta), entnehmen Sie bitte dem Typschild auf dem Gerät

Die minimale Prozesstemperatur entspricht der minimale Umgebungstemperatur

Temperatur FLS-XKSI

Temperaturklasse	zulässige Umgebungstemperatur	Prozesstemperatur	Oberflächentemperatur (EPL Db)
T4...T1	-20 ... +80°C	-20 ... +80°C	-

Typenschlüssel FLS...I / 60-... (Ex i)

Feld-Nr.	Code	Beschreibung		
Grundtyp				
1	FLS...I oder 60...	Hersteller KSR Kuebler		
		Namurbe- schaltung	Vorwi- derstand	Beschreibung
	FLS-SBI	FLS-SBNI	FLS-SBRI	Schwimmerschalter, in-Tank/mit Bezugsgefäß, Anschlussgehäuse/Stecker
	FLS-MBI	FLS-SBNI	FLS-SBRI	Schwimmerschalter, in-Tank/mit Bezugsgefäß (Mini guide tube), Anschlussgehäuse/Stecker
	FLS-SEI	FLS-SENI	FLS-SERI	Schwimmerschalter, in-Tank/mit Bezugsgefäß, mit Anschlusskabel
	FLS-MEI	FLS-SENI	FLS-SERI	Schwimmerschalter, in-Tank/mit Bezugsgefäß(Mini guide tube), mit Anschlusskabel
Anschlussgehäuse				
2	A	Aluminium		
	AV4	Edelstahl		
	APL	Polyester (ableitfähig)		
	ASC	Gerätestecker C091D		
	ASC4	Gerätestecker DIN EN 175301-803 (bisher DIN 43650, 4-polig)		
	ASHBB/ASHBA	Aluminiumstecker HTS gewinkelt/gerade		
	ASM	Gerätestecker M12		
	-	Entfällt bei Kabel		
Prozessanschluss				
3a Typ	F	Flansch		
	FC	Triclamp-Flansch		
	MR	Milchrohrverschraubung gem. DIN 11851		
	R	Einschraubgewinde		
3b Material	V	Edelstahl		
	HB	Hastelloy B		
	HC	Hastelloy C		
	T	Titan		

Feld-Nr.	Code	Beschreibung
3c	10 ... 250	Metrisch (falls anwendbar)
Nennweite	1 ... 6	Inch (falls anwendbar)
3d	6 ... 64	gem. DIN oder EN (falls anwendbar)
Druckstufe	150 ... 600	gem. ANSI (falls anwendbar)
3e	C, F, N	gem. DIN (falls anwendbar)
Dichtfläche	B1, B2, C, D	gem. EN (falls anwendbar)

Winkelausführung (optional)

4a	0 ... 180	Winkelmaß
4b	50 ... 500	Horizontale Länge des Gleitrohrs

Material Gleitrohr

5	V	Edelstahl
	HB	Hastelloy B
	HC	Hastelloy C
	T	Titan

Kontaktfunktion

6	S	Schließer bei steigendem Niveau
	O	Öffner bei steigendem Niveau
	U	Umschalter
6a	N	Schaltkreis gem. NAMUR DIN EN 60947-5-6
	R22	Schutzwiderstand 22 Ohm

Gleitrohrlänge und -durchmesser

7a	L...	Vertikale Länge des Gleitrohrs in mm
7b	...	Durchmesser des Gleitrohrs in mm

Schwimmer

8	V...A ¹	Schwimmermaterial Edelstahl
	T...A ¹	Schwimmermaterial Titan
	HB...A ¹	Schwimmermaterial Hastelloy B
	HC...A ¹	Schwimmermaterial Hastelloy C

Bezugsgefäß (optional) textlich beschrieben

9a	BZG...	Siehe separaten Schlüssel
	TV ...	T-Stück, Edelstahl, nominelle Größe, z.B. 1“
9b	...	Prozessanschluss Bezugsgefäß, z.B. GN1“ = Gewindenippel 1“

Zulassung

10	Ex	ATEX 2014/34/EU
----	----	-----------------

1: ... äußerer Durchmesser (s. Datenblatt für weitere Details)

	(1)	(2)	(3)	(4)	(5)	(6)	(7)	(8)	(9)	(10)
Typ:	<input type="text"/>	<input type="text"/>	<input type="text"/>	<input type="text"/>	<input type="text"/>	<input type="text"/>	<input type="text"/>	<input type="text"/>	<input type="text"/>	<input type="text"/>

Beispiel:

60-AFV 50/16/C-VSOU-L900/12-V52A-Ex

Weitere technische Daten siehe Datenblatt FLS und LM 30.01.

English

1. General

- The Float switch described in the operating instructions is designed and manufactured according to current state of the art technology. All components are subject to strict quality and environmental criteria during production. Our management systems are certified in accordance with ISO 9001.
- These operating instructions provide important information on dealing with this device. A prerequisite for safe operation is compliance with all indicated safety and operating instructions.
- Comply with the local accident prevention regulations and general safety provisions for the device.
- The operating instructions are part of the product and must be kept in the immediate vicinity of the device at all times for qualified personnel. The operating instructions must be passed on to subsequent users or owners of the device.
- The qualified personnel must carefully read and understand these operating instructions prior to any work.
- The general terms and conditions of business in the sales documents shall apply.
- Subject to technical changes.
- Further information:
 - Website: www.ksr-kuebler.com or www.wika.de

Abkürzungen, Definitionen

L-SP	Level-switch point
T-SP	Temperature-switch point
NO/NC	Open / Close Contact
CO	Change-over Contact

2. Layout and Function

2.1 Functional descriptions

Float switches work according to the float principle with magnetic transmission. A reed contact incorporated into the guide tube is activated by the magnetic field of a permanent magnet when reaching a predetermined switch point. The permanent magnet is located in a float which changes its elevation with the fluid level of the measuring material to be monitored. The switch condition of the reed contact can be evaluated and further processed using a downstream control device.

The number and location of the floats depends on the number of prescribed switch points, their contact function depends and the distance between switch points.

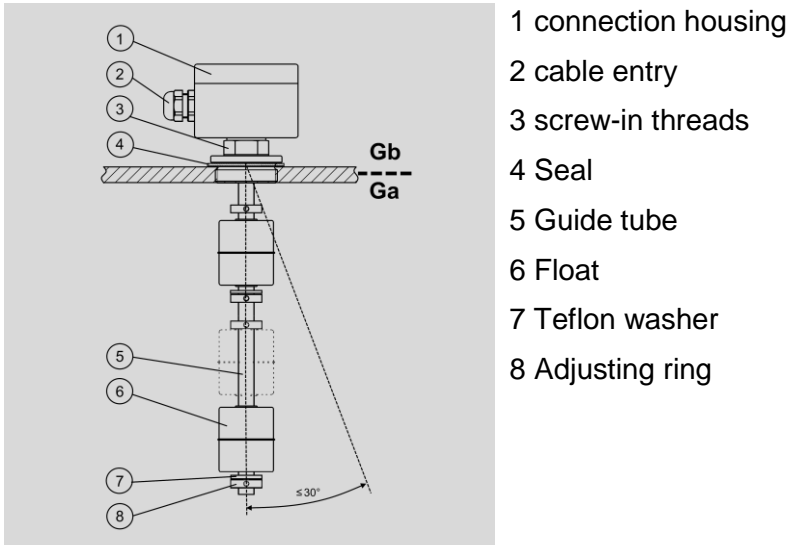

- 1 connection housing
- 2 cable entry
- 3 screw-in threads
- 4 Seal
- 5 Guide tube
- 6 Float
- 7 Teflon washer
- 8 Adjusting ring

Float switch FLS...I and 60... are approved for use in Ex zones.

Type	Protection class	Use in Hazard Zones	EU type examination certificate
FLS...I / 60-...	Ex i (intrinsically safe)	Zone 0/1, 1 and 2	KEMA 01 ATEX 1053 X

2.2 Delivery contents

Match the delivery contents with the delivery note.

3. Safety

3.1 Symbol legend



DANGER!

... refers to an imminent danger that can result in death or serious injury if not avoided.



WARNING!

... refers to a potential danger that can result in death or serious injury if not avoided.



CAUTION!

... refers to a potentially dangerous situation, that can lead to minor injuries or property and environmental damages , if not avoided.



INFORMATION

... highlights useful tips and recommendations as well as information for efficient and fault-free operation



Note for ex devices

... highlights the relevant and/or necessary information which is required for operation in potential explosive areas.

3.2 Intended use

The Float switches are intended solely for level monitoring of fluids. The range of application results from the technical performance limits and materials.

- The liquids must not have any heavy soiling or coarse particles and must not have a tendency to crystallise. It must be ensured that the materials of the measuring transducer which come into contact with the material are sufficiently resistant to the measuring material to be monitored. Not suitable for dispersions, abrasive liquids, highly viscous mediums and paints.
- The operating conditions specified in the operating instructions must be observed.
- Do not operate the device in the immediate vicinity of ferromagnetic surroundings (distance min. 50 mm).
- Do not operate the device in the immediate vicinity of strong electromagnetic fields, or in the immediate vicinity of equipment which can be influenced by magnetic fields (distance min. 1 m).
- The Float switches may not be subjected to any strong mechanical loads (impact, twisting, vibrations).
- The technical specifications in these operating instructions must be observed. Improper handling or operation of the device outside the technical specifications makes careful shut-down and monitoring by an authorised WIKA service employee.

Approval KEMA 01 ATEX 1053 X	
FLS...I / 60...	II 1/2 G Ex ia IIC T6...T1 Ga/Gb II 2 D Ex ib IIIC T80°C...T230°C Db
FLS-XKSI	II 1/2 G Ex ia IIC T4...T1 Ga/Gb
Special design without fall protection	
FLS...I / 60...	II 1/2 G Ex ia IIB T6...T1 Ga/Gb II 2 D Ex ib IIIC T80°C...T230°C Db
FLS-XKSI	II 1/2 G Ex ia IIB T4...T1 Ga/Gb
Float and sliding pipe in zone 0	



Note for ex devices

FLS...I / 60...-... Float Switches are approved as explosion-proof equipment within the scope of EC directive 2014/34/EU for use in potentially explosive atmospheres. They fulfil the requirements of electric equipment for potentially explosive atmospheres.

The technical data in these operating instructions must be observed.

The device is designed and constructed solely for its intended purpose described here and may only be used accordingly.

Claims of any type resulting from non-intended use are excluded.



DANGER!

When working on containers there is a risk of poisoning, asphyxiation or burns. Work may only be conducted using appropriate personal protection measures (e.g. breathing apparatus, protective clothing, or the like).



Note for ex devices

Caution explosion hazard!

There is a risk of potentially explosive atmosphere in the container. Corresponding measures which prevent sparking should be taken. Work in this area may only be conducted by qualified personnel in accordance with the respective applicable safety guidelines.

3.3 Improper use

Improper use is any use which exceeds the technical performance limits or is incompatible with the materials.



WARNING!

Injuries as a result of improper use

Improper use of the device can lead to dangerous situations and injuries

Refrain from unauthorised modifications to the device.

Any use other than for the intended purpose or any other use is considered improper use.

Do not use this device in safety devices or in emergency stop equipment.

3.4 Owner's responsibility

The device is used in the commercial sector. Therefore, the operator is subject to the legal obligations for occupational health and safety.

The safety information in these operating instructions as well as the safety, accident prevention and environmental protection regulations applicable to range of application for the device must be observed.

For safe operation of the device the operator must ensure:

- that the operating personnel receives regular instruction in all applicable areas of occupational safety and environmental protection.
- that these operating instructions and, in particular, the safety information contained therein, will be duly noted.
- that the device is suitable for the application pursuant to its intended use.

3.5 Personnel qualifications



WARNING!

Risk of injury as a result of insufficient qualification

Improper handling can lead to significant injuries and material damage.

- The operations in these operating instructions should only be completed by qualified personnel with the qualifications described below.

Qualified personnel

Qualified personnel authorised by the operator must be able to complete the work described and independently identify possible dangers based on his professional training, his knowledge of measurement and control technology and experience as well as knowledge of the country-specific provisions, and applicable standards and directives.

3.6 Personal protective equipment

Personal safety equipment serves to protect qualified personnel against risks that can negatively impact their safety or health while working. When conducting work on and with the device the qualified personnel must wear personal safety equipment.

Follow the information affixed in the work area for personal protective equipment!

The personal protective equipment required must be made available by the operator.

3.7 Labelling, Safety labelling

Type plate example

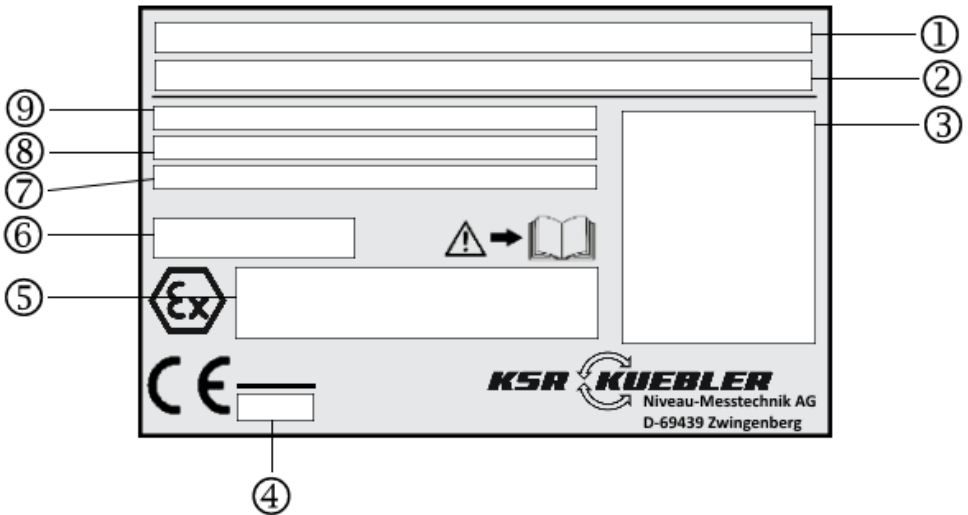

- 1 - Type, name
- 2 - Device coding
- 3 - Circuit diagram
- 4 - Notified body according to EU Directive 2014/34/EU
- 5 - Certificate number and Ex labelling
- 6 - Protection class according to and ambient temperature
- 7 - Article number, Serial number, year of manufacture
- 8 - Auslegungsdruck PS, Prüfdruck PT, Auslegungstemperatur TS
- 9 - Electrical Data

Symbols



Read the operating instructions and before assembly and commissioning of the device and note the EU type examination certificate!

4. Transport, packaging and storage

4.1 Transport

Inspect the Float switch for possible existing transportation damages. Immediately report obvious damages.



CAUTION!

Damage caused by improper transport

Significant property damages can result from improper transport.

- Note symbols on the packaging
- Careful handle packages

4.2 Packaging and storage

Only remove packaging immediately prior to commissioning.

5. Commissioning, Operation

- Observe all information provided on the package for removing the transport locks.
- Carefully remove the Float Switch from the packaging!
- Carefully inspect all parts for outward damage when unpacking.
- Conduct a functional test prior to installation

5.1 Functional test



Funktionsprüfung

Prior to assembly the Float switch can be connected as described in section 5.3 and the switching points can be manually activated.



WARNUNG!

Ensure that the functional test does not start any unintended processes.



Note for ex devices

For the functional test use testing equipment which is appropriate, or approved for use in potentially explosive atmospheres. These operations may only be performed by qualified personnel.



Note for Ex devices

Float Switch Type FLS...I or 60... Ignition protection type Ex i may only be connected to certified intrinsically safe circuits in the Ex area of Zone 0/1 (float and guide tube in Zone 0). While doing so, the maximum operating data must be observed.

Devices with a powder coating, plastics, or adhesive type plates made of plastic > 500 mm² may not be used in areas in which strong charge generating processes, mechanical blending or separating processes, the spraying of electrons, for example, in the area of electrostatic painting systems, take place or where pneumatically promoted dust escapes.

Equipotential bonding

The device must be integrated in the equipotential bonding of the plant.

Chemical reactions, or spontaneous combustion processes may only originate from the medium itself not from the device. The ignition hazards from the medium itself must be taken into consideration by the operator and prevented.

High or low temperatures and/or high pressures inside the container influence the safety parameters of the occurring substances. If pressures or temperatures arise in the interior of the container in the non-atmospheric area then the operator himself must check what influences these conditions have on the safety parameters of the occurring substances and what direct ignition hazards result from this

5.2 Assembly

- Comply with the torque values provided in the pipeline construction.
- When selecting the assembly material (seals, screws, washers and nuts) observe the process conditions. The seal must be suitable with regard to the measuring material and its vapours. In addition, attention must be paid to the corresponding corrosion resistance.
- Install float switch either using screw-in thread (3) or mounting flange (not depicted).

- The guide tube (5) may be tilted a maximum of 30° from the vertical.
- The number of floats as well as the position of the float stops depends on the dimensions and number of the switch points.

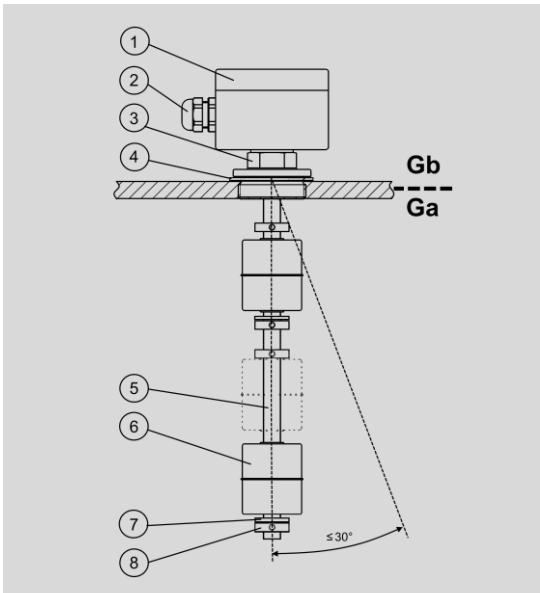

- 1 connection housing
- 2 cable entry
- 3 screw-in threads
- 4 Seal
- 5 Guide tube
- 6 Float
- 7 Teflon washer
- 8 Adjusting ring



Note for ex devices

A Teflon washer on the float stops prevents sparking when the float falls onto it. The use of this device without this Teflon washer is not permitted. *

*Except KSR special versions for gas group IIB without Teflon washer

In containers in which the occurrence of turbulence is expected float switches with a length of over 3000mm must also be secured against bending the guide tube. This can be done by, for example, using a carrier sleeve on the container base.

If titanium floats are used, care must be taken to ensure that these floats cannot generate any friction or impact sparks, even in rare cases.

5.3 Electrical connection

- The electrical connection may only be carried out by qualified personnel.
- The assignment of the connections and the switch functions are specified on the connection diagram on the device and the terminals are labelled accordingly (Exception: Designs with only one break or make contact).
- Seal the cable entry on the connection housing. Use suitable cable glands to maintain the IP protection class.



WARNING!

Errors in the electrical connection of float switches can destroy the reed contacts. This can lead to a malfunction of the system and thus to personal injury or property damage.

- No direct operation on switches with inductive load.
- No direct operation on switches with capacitive load, e.g. SPS, PLS or line lengths > 50 m.
- No exceeding the permissible switching capacity.



Note for Ex devices Ex i

Float Switches Type FLS...I oder 60... Ignition protection Ex i may only be connected to certified intrinsically safe circuits (ia) in the Ex area of Zone 0/1 (float and guide tube in Zone 0). The electrical data on the type plate must be observed.

The national provisions for installation of intrinsically safe control circuits must be observed. (see 9.1 Switching capacities / Electrical values)

The interior capacity and inductivity of the cables used with regard to the downstream intrinsically safe control device must be observed.

Works may only be carried out by trained personnel.

Only cable entries and sealing plugs with an EC type examination certificate according to EN 60079-0 and for Ex i devices according to EN 60079-7 (Ex e) may be used.

They must be certified for at least the same temperature range and IP protection as the measuring transducer. Furthermore, it is important to ensure that the thread size and thread version complies with the respective device model of the housing and that the screws are suitable for the connection cable used. The use of single strands is not permitted! In the event of non-compliance the type approval expires.

Unused openings for cable entries must be permanently sealed with approved plugs, Ex e IIC for the EX i version.

For commissioning accessories it is imperative that you observe the respective assembly and operating instructions.

The electrical data on the type plate must be observed. The connection must be made in accordance with the connection diagram. When selecting the cable ensure that it is appropriate for use in the intended range of application (temperature, weather conditions, aggressive atmosphere, etc.) and for the cable gland used.



Connecting the cable

The connection cable should be laid in accordance with the applicable guidelines for building electrical circuits

Switch of voltage for electrical circuit

Remove the cover of the terminal box

Feed the cable through the cable gland into the terminal box

Strip off the cable sheath.

Caution! no single strands may be fed through the cable gland. Always ensure that the cable goes with the cable gland used and the cable sheath is securely clamped into the cable gland.

Insulate the strands and fit them with wire end sleeves

Insert and fasten the wires into the clamps in accordance with the respective requirements

Place housing cover back on and fasten.

The respective connection diagram must be observed



Equipotential bonding













































































In the case of a measuring transducer with connection housing, at least one terminal is available for equipotential bonding inside or on the outside of the housing.









































In the case of measuring transducers with cables the operator must incorporate the measuring transducer into the earthing for the tank, incorporated container or installation situation.

Observe the earthing symbol in or on the housing.

Circuit diagrams

Colour abbreviations

Switching points	PVC cable		Silicone cable		Connection housing	
	NO/NC	CO	NO/NC	CO	NO/NC	CO
1 L-SP	WH  L1 BN  L1	WH  L1 BN  L1 GN  L1	X*  L1 BN  L1 X*= WH or BU		1  L1 2  L1	1  L1 2  L1 3  L1
2 L-SP	WH  L1 BN  L1 GN  L2 YE  L2	WH  L1 BN  L1 GN  L1 YE  L2 PK  L2 GY  L2	WH  L1 BN  L1 GN  L2 YE  L2		1  L1 2  L1 3  L2 4  L2	1  L1 2  L1 3  L1 4  L2 5  L2 6  L2
3 L-SP	WH  L1 BN  L1 GN  L2 YE  L2 PK  L3 GR  L3				1  L1 2  L1 3  L2 4  L2 5  L3 6  L3	1  L1 2  L1 3  L1 4  L2 5  L2 6  L2 7  L3 8  L3 9  L3
4 L-SP					1  L1 2  L1 3  L2 4  L2 5  L3 6  L3 7  L4 8  L4	1  L1 2  L1 3  L1 4  L2 5  L2 6  L2 7  L3 8  L3 9  L3 10  L4 11  L4 12  L4

Switching points	PVC cable		Silicone cable		Connection housing	
	NO/NC	CO (L-SP)	NO/NC	CO	NO/NC	CO
1 L-SP and 1 T-SP	WH  L1 BN  GN  9 YE 	WH  L1 BN  L1 GN  9 YE  9 PK	WH  L1 BN  GN  9 YE 		1  L1 2  3  9 4 	1  L1 2  L1 3  4  9 5  9
2 L-SP and 2 T-SP	WH  L1 BN  GN  9, YE  PK  9, GY				1  L1 2  3  9, 4  5  9, 6  7  9,	1  L1 2  L1 3  4  9, 5  9, 6  9, 7  9,

Pin assignment connector

Switching points	ASHBB / ASHBA					
	NO/NC	CO	NO/NC	CO	NO/NC	CO
1 L-SP	1  L1 2 	1  L1 2  L1 3 				
2 L-SP	1  L1 2  3  L2 4 	1  L1 2  L1 3  4  L2 5  L2 6 				
3 L-SP	1  L1 2  3  L2 4  5  L3 6 					

Please note the Circuit diagrams on the device. These can differ from the examples given here.



Warning!

Operation of the magnetic switch on inductive or capacitive load can result in destruction of the reed contact. This can lead to a malfunction of the downstream control and cause personal injury or property damage.

In the event of capacitive load, cable lengths over 50m or connection to process control systems with capacitive entry a protective resistor of 22Ω should be connected in series to limit the peak current.

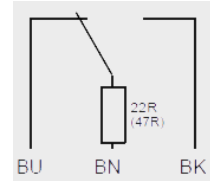

5.4 Commissioning

Switch on the power supply of the connected control device. Fill container and check the switch points of the float switch for function.



WARNING!

Ensure that the functional test does not start any unintended processes.

For commissioning accessories it is imperative that you observe the respective assembly and operating instructions.

6. Faults



The most frequent causes for faults and the countermeasures necessary are listed in the tables below.

Fault	Cause	Measure
Float switch can not be attached in the location intended on the container	Process connection of the float switch does not fit with the process connection of the container.	Retrofitting of the container Return to factory
	Process connection on container defective	Reworking of the thread or replacement of the fastening sleeve
	Screw-in thread on float switch defective	Return to factory
No or undefined switch function	Electrical connection incorrect	See Section 5.3 "Electrical Connection". Check configuration with the help of the circuit diagram.
	Temperature contact defective	Return to factory
	Reed contact defective	Return to factory



CAUTION!

Bodily injuries, property and environmental damages

If faults cannot be remedied with the help of the measures listed above immediately decommission the device.

- Ensure that there is no more pressure and protect against accidental commissioning.
- Contact the manufacturer.
- In the event a return is necessary note the instructions in Section 8.2 "Return".

7. Maintenance and cleaning

7.1 Maintenance

When properly used, Float Switches are maintenance and wear free. However, they must be given a visual inspection as part of regular maintenance and incorporated into the pressure test of the container.



DANGER!

When working on containers there is a risk of poisoning or asphyxiation. Work may only be conducted using appropriate personal protection measures (e.g. breathing apparatus, protective clothing, or the like).

Repairs may only be performed by the manufacturer.



NOTE!

Proper function of the Float Switch can only be guaranteed when using KSR Kuebler accessories and replacement parts

7.2 Cleaning



CAUTION!

Bodily injuries, property and environmental damages

Improper cleaning leads to bodily injuries, property and environmental damages. Residual media in removed devices can lead to danger to persons, the environment and the equipment.

- Rinse, or clean the removed device.
 - Appropriate precautionary measures must be taken.
1. Before cleaning the device separate the device properly from the process and the power supply.
 2. Carefully clean the device with a damp cloth.
 3. Do not bring electrical connections in contact with moisture!



CAUTION!

Property damage

Improper cleaning will damage the device!

- Improper cleaning will damage the device!
- Do not use any hard or sharp objects for cleaning.

8. Dismantling, returns and disposal



WARNING!

Bodily injuries, property and environmental damages from residual media

Residual media in the removed device can lead to danger to persons, the environment and the equipment.

- Wear necessary protective equipment
- Rinse, or clean the removed device in order to protect people and the environment from hazards resulting from residual media.

8.1 Dismantling

Only dismantle the measuring device in an unpressurised and voltage-free state!

If necessary, the container must be released.

8.2 Returns

Rinse, or clean the removed Float Switch in order to protect employees and the environment from hazards resulting from residual media.



Information on returns can be found in the “Service” rubric on our local website.

8.3 Disposal

Incorrect disposal can result in danger to the environment. Device components and packaging materials must be disposed of in an environmentally friendly way in accordance with the country-specific waste and disposal regulations.

9. Technical data

9.1 Marking

Type	Approval KEMA 01 ATEX 1053 X
FLS...I / 60...	II 1/2 G Ex ia IIC T6...T1 Ga/Gb II 2 D Ex ib IIIC T80°C...T230°C Db
FLS-XKSI	II 1/2 G Ex ia IIC T4...T1 Ga/Gb
Special design without fall protection	
FLS...I / 60...	II 1/2 G Ex ia IIB T6...T1 Ga/Gb II 2 D Ex ib IIIC T80°C...T230°C Db
FLS-XKSI	II 1/2 G Ex ia IIB T4...T1 Ga/Gb
	Float and sliding pipe in zone 0

9.2 Electrical data

Type	Measuring chain
FLS...I 60...	Ex ia $U_i \leq 36 \text{ V}$, $I_i \leq 100 \text{ mA}$, $P_i \leq 0,84\text{W}$, $C_i = 0 \text{ nF}$, $L_i = 0 \text{ mH}$
FLS...NI 60... (Namur)	Ex ia $U_i \leq 18,5 \text{ V}$, $I_i \leq 30 \text{ mA}$, $P_i \leq 0,4\text{W}$, $C_i = 0 \text{ nF}$, $L_i = 0 \text{ mH}$
FLS...RI 60... (Rv)	Ex ia $U_i \leq 36 \text{ V}$, $I_i \leq 100 \text{ mA}$, $P_i \leq 0,84\text{W}$, $C_i = 0 \text{ nF}$, $L_i = 0 \text{ mH}$
Only for connection to a certified intrinsically safe circuit	
Optional circuit for a (or a combination of) PT100, PT1000, temperature switch in intrinsically safe Ex ia	
	$U_i \leq 30 \text{ V}$; $I_i \leq 120\text{mA}$, $P_i \leq 0,9 \text{ W}$, $C_i = 0 \text{ nF}$; $L_i = 0 \text{ mH}$
Namur	$U_i \leq 18,5 \text{ V}$, $I_i \leq 30 \text{ mA}$, $P_i \leq 0,4\text{W}$, $C_i = 0 \text{ nF}$; $L_i = 0 \text{ mH}$
If an optional ATEX head transducer is used, for example, additional option PT100 with head transducer, the electrical data on the corresponding KSR type plate apply.	
Only for connection to a certified intrinsically safe circuit	

9.3 Temperatures



Temperature FLS...I

Temperature class	permissible ambient temperature (Ta)*	Process temperature - FLS...I	Process temperature FLS...I Contact with resistor circuit	Surface temperature (EPL Db)
T1	-50*1...+80°C	≤ 200°C	≤ 200°C	≤ 230°C
T2	-50*1 ...+80°C	≤ 200°C	≤ 200°C	≤ 230°C
T3	-50*1...+80°C	≤ 195°C	≤ 165°C	≤ 195°C
T4	-50*1...+80°C	≤ 130°C	≤ 100°C	≤ 130°C
T5	-50*1...+65°C	≤ 95°C	≤ 65°C	≤ 95°C
T6	-50*1...+50°C	≤ 80°C	≤ 50°C	≤ 80°C

*Ambient temperature is the temperature at the connection housing, connection cable, or connecting plug

*1 Die minimale Umgebungstemperatur kann je nach Ausführung eingeschränkt sein. Die für ihr Gerät zugelassene Umgebungstemperatur (Ta), entnehmen Sie bitte dem Typschild auf dem Gerät

Die minimale Prozesstemperatur entspricht der minimale Umgebungstemperatur

Temperatur FLS-XKSI

Temperature class	permissible ambient temperature (Ta)	Process temperature	Surface temperature (EPL Db)
T4...T1	-20 ... +80°C	-20 ... +80°C	-

Type code FLS...I / 60-... (Ex i)

Field-Nr.	Code	Description		
Basic type				
1	FLS...I or 60...	Manufacturer KSR Kuebler		
		Namur wiring	Series resistor	Description
	FLS-SBI	FLS-SBNI	FLS-SBRI	Float switch, in-tank/with external chamber, terminal housing/coupler plug
	FLS-MBI	FLS-SBNI	FLS-SBRI	Float switch, in-tank/with external chamber (mini guide tube), terminal housing/coupler plug
	FLS-SEI	FLS-SENI	FLS-SERI	Float switch, in-tank/with external chamber, with connection cable
	FLS-MEI	FLS-SENI	FLS-SERI	Float switch, in-tank/with external chamber (mini guide tube), with connection cable
Connection housing/plug				
2	A	Aluminium		
	AV4	Stainless steel		
	APL	Polyester (conductive)		
	ASC	Coupler plug C091D		
	ASC4	Coupler plug DIN EN 175301-803 (previously DIN 43650, 4-pin)		
	ASHBB/ASHBA	Coupler plug HTS angled/straight		
	ASM	Coupler plug M12		
	-	Omitted on connection cable version		
Proess connection				
3a Type	F	Threaded connection upwards		
	FC	Flange		
	MR	Triclamp-Flange		
	R	Dairy pipe connection in acc. with DIN 11851		
3b Material	V	Stainless steel		
	HB	Hastelloy B		
	HC	Hastelloy C		
	T	Titan		

Field-Nr.	Code	Description
3c	10 ... 250	Metric (if applicable)
Nominal size	1 ... 6	Inch (if applicable)
3d	6 ... 64	acc. to DIN or EN (if applicalbe)
Pressure rating	150 ... 600	acc. to ANSI (if applicalbe)
3e	C, F, N	acc. to DIN (if applicable)
Sealing face	B1, B2, C, D	acc to. EN (if applicable)

Angled version (optional)

4a	0 ... 180	Angle
Angle		
4b	50 ... 500	Horizontal length of guide tube
Angle- length		

Material guide tube

5	V	Stainless steel
	HB	Hastelloy B
	HC	Hastelloy C
	T	Titanium

Contact function

6	S	Closing on rising level
	O	Opening on rising level
	U	Changeover contact
6a	N	Circuitry acc to NAMUR DIN EN 60947-5-6
	R22	Protective resistor 22 Ohm

Guide tube length and –diameter

7a	L...	Vertical length of guide tube in mm
7b	...	Diameter of guide tube in mm

Float

8	V...A ¹	Float material stainless steel
	T...A ¹	Float material titanium
	HB...A ¹	Float material Hastelloy B
	HC...A ¹	Float material Hastelloy C

External chamber (optional) generic description included

9a	BZG...	See separate typecode
	TV ...	T-piece, stainless steel, nominal size, e.g. 1"
9b	...	Process connection external chamber, e.g. GN1" = male thread 1"

Approval

10	Ex	ATEX 2014/34/EU
----	----	-----------------

¹:... outer diameter (see data sheet for further details)

	(1)	(2)	(3)	(4)	(5)	(6)	(7)	(8)	(9)	(10)
Type:	<input type="text"/>	<input type="text"/>	<input type="text"/>	<input type="text"/>	<input type="text"/>	<input type="text"/>	<input type="text"/>	<input type="text"/>	<input type="text"/>	<input type="text"/>

Example:

60-AFV 50/16/C-VSOU-L900/12-V52A-Ex

For further technical data, see data sheet FLS and LM 30.01.

10 Appendix / Anhang



Ex i

EC Declaration of Conformity EU-Konformitätserklärung



EU-Konformitätserklärung EU Declaration of Conformity

Dokument Nr.: 1111_03
Document No.:

Wir erklären in alleiniger Verantwortung, dass die mit CE gekennzeichneten Produkte
We declare under our sole responsibility that the CE marked products

Typenbezeichnung: FLS...I; (Serie 60)
Type Designation: FLS...I; (Series 60)

Beschreibung: Schwimmer Magnetschalter
Description: Magnetic Float Switch

die grundlegenden Schutzanforderungen der folgenden Richtlinien erfüllen: Harmonisierte Normen:
comply with the essential protection requirements of the directives: Harmonized standards:

2011/65/EU Gefährliche Stoffe (RoHS)
Hazardous substances (RoHS)

EN 50581:2012
EN IEC 63000:2018

2014/34/EU Explosionsschutz (ATEX)⁽¹⁾⁽²⁾
Explosion protection (ATEX)⁽¹⁾⁽²⁾

Zertifiziert nach / Certified to
EN IEC 60079-0:2018
EN 60079-11:2012
EN 60079-26:2015

(1) EG-Baumusterprüfbescheinigung KEMA 01 ATEX 1053 X von DEKRA Certification B.V. Meander 1051, 6825 MJ Arnhem, Niederlande (Reg.-Nr. 0344).
EC type examination certificate KEMA 01 ATEX 1053 X von DEKRA Certification B.V. Meander 1051, 6825 MJ Arnhem.

(2) Notifizierte Stelle: IBExU Institut für Sicherheitstechnik GmbH, Fuchsmühlenweg 7, 09599 Freiberg (Reg.-Nr. 0637).
Notified Body: IBExU Institut für Sicherheitstechnik GmbH, Fuchsmühlenweg 7, 09599 Freiberg (Reg. no. 0637).

Unterzeichnet für und im Namen von / Signed for and on behalf of
KSR Kuebler Niveau-Messtechnik GmbH

Stefan Amendt, Technischer Leiter

Zwingenberg, 2020-07-21



Ex i

EC-Type Examination Certificate EG-Baumusterprüfbescheinigung

CERTIFICATE

(1) EU-Type Examination

(2) Equipment or protective systems intended for use in potentially explosive atmospheres - Directive 2014/34/EU

(3) EU-Type Examination Certificate Number: **KEMA 01ATEX1053 X** Issue Number: 4

(4) Product: **Magnetic float switches series FLS or series 60**

(5) Manufacturer: **KSR KUEBLER Niveau-Messtechnik GmbH**

(6) Address: **Heinrich-Kübler-Platz 1, D-69439 Zwingenberg, Germany**

(7) This product and any acceptable variation thereto is specified in the schedule to this certificate and the documents therein referred to.

(8) DEKRA Certification B.V., Notified Body number 0344 in accordance with Article 17 of Directive 2014/34/EU of the European Parliament and of the Council, dated 26 February 2014, certifies that this product has been found to comply with the Essential Health and Safety Requirements relating to the design and construction of products intended for use in potentially explosive atmospheres given in Annex II to the Directive.

The examination and test results are recorded in confidential test report number: 215931500 Issue 2.

(9) Compliance with the Essential Health and Safety Requirements has been assured by compliance with:

EN IEC 60079-0 : 2018

EN 60079-11 : 2012

EN 60079-26 : 2015

except in respect of those requirements listed at item 18 of the Schedule.

(10) If the sign "X" is placed after the certificate number, it indicates that the product is subject to the Specific Conditions of Use specified in the schedule to this certificate.

(11) This EU-Type Examination Certificate relates only to the design and construction of the specified product. Further requirements of the Directive apply to the manufacturing process and supply of this product. These are not covered by this certificate.

(12) The marking of the product shall include the following:



II 1/2 G Ex ia IIC T6...T1 Ga/Gb or
II 2 D Ex ib IIC T80 °C...T230 °C Db

Date of certification: 27 May 2020

DEKRA Certification B.V.

R. Schuller
Certification Manager

Page 1/4



Integral publication of this certificate and adjoining reports is allowed. This Certificate may only be reproduced in its entirety and without any change.

DEKRA Certification B.V. Meander 1051, 6825 MJ Arnhem P.O. Box 5185, 6802 ED Arnhem The Netherlands
T +31 88 96 83000 F +31 88 96 83100 www.dekra-product-safety.com Registered Arnhem 09085396

(13) **SCHEDULE**

(14) to EU-Type Examination Certificate KEMA 01ATEX1053 X

Issue No. 4

(15) **Description**

The magnetic float switches series FLS or series 60 serves to monitor or to control the level in tanks of flammable liquids.

The magnetic float switch consists of one or more floats, a guide tube and a terminal box. One or more reedcontacts are located inside the guide tube of the float switch, which are actuated by the magnet inside their accompanying floats.

Optionally, the magnetic float switch may be provided with a PT100, PT1000, thermal switch, reedcontact or Namurswitch. These sensors can also be combined.

Dependent on the type, the magnetic float switch may be provided with one or two separately certified transmitters.

The permissible operating pressures and process temperatures are to be taken from the manufacturer's operating manual.

Ambient temperature range: -50 °C to +80 °C.

The minimum process temperature is equal to the minimum ambient temperature.

When an optional transmitter is applied, the thermal data as mentioned in its EU-Type Examination Certificate shall also be taken into account.

The relation between the temperature class, the maximum surface temperature, the maximum permissible ambient temperature and the maximum permissible process temperature shall be taken from the following tables:

Temperature class	Ambient temperature	Process temperature (see notes 1 and 2)		Surface temperature (EPL Db)
T1	≤ 80 °C	≤ 200 °C		≤ 230 °C
T2	≤ 80 °C	≤ 200 °C		≤ 230 °C
T3	≤ 80 °C	≤ 195 °C ¹⁾	≤ 165 °C ²⁾	≤ 195 °C
T4	≤ 80 °C	≤ 130 °C ¹⁾	≤ 100 °C ²⁾	≤ 130 °C
T5	≤ 65 °C	≤ 95 °C ¹⁾	≤ 65 °C ²⁾	≤ 95 °C
T6	≤ 50 °C	≤ 80 °C ¹⁾	≤ 50 °C ²⁾	≤ 80 °C

1) When only reed contacts are used (no optional circuit, see electrical data)

2) When optional circuit is present, e.g. with temperature sensor, thermal switch, limiting resistor and/or Namur switch

Restriction for variant FLS-XKSI:

Temperature class	Ambient temperature	Process temperature	Surface temperature (EPL Db)
T4...T1	-20 °C to +80 °C	-20 °C to +80 °C	not permitted

(13) **SCHEDULE**

(14) **to EU-Type Examination Certificate KEMA 01ATEX1053 X** Issue No. 4

Electrical data

Supply circuit of the reed contacts:

in type of protection intrinsic safety Ex ia IIC, only for connection to a certified intrinsically safe circuit, with the following maximum values:

$U_i = 36 \text{ V}$; $I_i = 100 \text{ mA}$; $P_i = 0,84 \text{ W}$; $C_i = 0 \text{ nF}$; $L_i = 0 \text{ }\mu\text{H}$.

When an optional transmitter is applied, the electrical data as mentioned in its EU-Type Examination Certificate shall be taken into account.

Optional circuit for (a combination of) a PT100, PT1000, thermal switch or reedcontact:

in type of protection intrinsic safety Ex ia IIC, only for connection to a certified intrinsically safe circuit, with the following maximum values:

$U_i = 30 \text{ V}$; $I_i = 120 \text{ mA}$; $P_i = 0,9 \text{ W}$; $C_i = 0 \text{ nF}$; $L_i = 0 \text{ }\mu\text{H}$.

When an optional transmitter is applied, the electrical data as mentioned in its EU-Type Examination Certificate shall be taken into account.

Optional circuit for a Namurswitch:

in type of protection intrinsic safety Ex ia IIC, only for connection to a certified intrinsically safe circuit, with the following maximum values:

$U_i = 18,5 \text{ V}$; $I_i = 30 \text{ mA}$; $P_i = 0,4 \text{ W}$; $C_i = 0 \text{ nF}$; $L_i = 0 \text{ }\mu\text{H}$.

When an optional transmitter is applied, the electrical data as mentioned in its EU-Type Examination Certificate shall be taken into account.

Installation instructions

The instructions provided with the product shall be followed in detail to assure safe operation.

(16) **Report Number**

No. 215931500 Issue 2.

(17) **Specific conditions of use**

For the relation between the temperature class, the maximum surface temperature, the maximum permissible ambient temperature and the maximum permissible process temperature see (15).

When floats of titanium are applied, ignition sources due to impact and friction sparks shall, even in the event of rare incidents, be avoided.

Variants of this equipment with powder coating, plastics or adhesive labels $> 500 \text{ mm}^2$ on a metal enclosure may not be used in areas where electrostatic charging occurs, for example as a result of mechanical friction or separation processes, the spraying of electrons, e.g. in the vicinity of electrostatic painting equipment, or where pneumatically conveyed dust escapes.

(18) **Essential Health and Safety Requirements**

Covered by the standards listed at item (9).

(19) **Test documentation**

As listed in Report No. 215931500 Issue 2.

(13) **SCHEDULE**

(14) to EU-Type Examination Certificate KEMA 01ATEX1053 X Issue No. 4

(20) Certificate history

Issue 1 - 6410100	Initial certificate
Issue 2 - 212399700	Assessed to the newest standards
Issue 3 - 215930700	Assessed to the newest standards
Issue 4 - 224014900	Assessed to the standards EN IEC 60079-0 : 2018 and EN 60079-26 : 2015. And constructional changes

KSR Kuebler subsidiaries worldwide can be found online at www.ksr-kuebler.com.
WIKA subsidiaries worldwide can be found online at www.wika.com.



KSR Kuebler Niveau-Messtechnik GmbH

Heinrich-Kuebler-Platz 1
69439 Zwingenberg am Neckar • Germany
Tel. +49 6263/87-0
Fax +49 6263/87-99
info@ksr-kuebler.com
www.ksr-kuebler.com