

Valid from software version:
2.2.zz (device firmware)

Operating Instructions

Teqwave T

Measuring device with surface acoustic wave technology

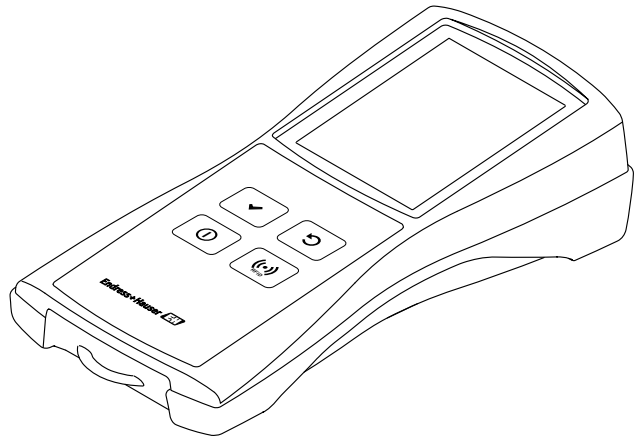

- Make sure the Operating Instructions are stored in a safe place so they are always available when working on or with the device.
- To avoid danger to individuals or the facility, read the "Basic safety instructions" section carefully, as well as all other safety instructions in the Operating Instructions that are specific to working procedures.
- The manufacturer reserves the right to modify technical data without prior notice. The Endress+Hauser Sales Center will supply you with current information about, and updates to, these Operating Instructions.

Table of contents

1	About this document	4	9	Operation	34
1.1	Document purpose	4	9.1	Changing the operating language	34
1.2	Symbols used	4	9.2	Performing the measurement	34
1.3	Documentation	5	9.3	Reading measured values	35
1.4	Registered trademarks	5	9.4	Additional dosage	36
2	Basic safety instructions	6	9.5	Accessing the measured data	37
2.1	Requirements for personnel	6	9.6	Loading measured values in the operating tool	40
2.2	Designated use	6	9.7	Updating the firmware	40
2.3	Occupational safety	6	10	Diagnostics and troubleshooting	42
2.4	Operational safety	7	10.1	General troubleshooting	42
2.5	Product safety	7	10.2	Error messages	42
2.6	IT security	7	10.3	Checking the measuring device	43
3	Product description	8	10.4	Device information	44
3.1	Product design	8	10.5	Firmware history	44
3.2	Concentration apps, measuring points	8	11	Maintenance	45
4	Incoming acceptance and product identification	10	11.1	Maintenance tasks	45
4.1	Incoming acceptance	10	11.2	Endress+Hauser services	45
4.2	Product identification	10	12	Repair	46
5	Storage and transport	12	12.1	General information	46
5.1	Storage conditions	12	12.2	Spare parts	46
5.2	Transporting the product	12	12.3	Endress+Hauser services	46
5.3	Packaging disposal	12	12.4	Return	46
6	Electrical connection	13	12.5	Disposal	47
6.1	Connection conditions	13	13	Accessories	48
6.2	Connecting the measuring device	13	13.1	Device-specific accessories	48
6.3	Post-connection check	14	13.2	Service-specific accessories	48
7	Operating options	15	14	Technical data	49
7.1	Overview of the operating options	15	14.1	Application	49
7.2	Access to the measuring device via the local display	15	14.2	Function and system design	49
7.3	Access to the measuring device via the operating tool	18	14.3	Input	49
8	Commissioning	24	14.4	Power supply	49
8.1	Function check	24	14.5	Performance characteristics	50
8.2	Charging the battery	24	14.6	Environment	51
8.3	Switching on the measuring device	24	14.7	Process	51
8.4	Configuring the measuring device	25	14.8	Mechanical construction	51
8.5	Advanced settings via the operating tool	26	14.9	Operability	52
			14.10	Certificates and approvals	52
				Index	53





1 About this document

1.1 Document purpose





These Operating Instructions contain all the information that is required in the various phases of the life cycle of the device: from product identification, incoming acceptance and storage, to connection, operation and commissioning through to troubleshooting, maintenance and disposal.

1.2 Symbols used



1.2.1 Safety symbols







Symbol	Meaning
 A0011189-EN	DANGER This symbol alerts you to a dangerous situation. Failure to avoid this situation will result in serious or fatal injury.
 A0011190-EN	WARNING This symbol alerts you to a dangerous situation. Failure to avoid this situation can result in serious or fatal injury.
 A0011191-EN	CAUTION This symbol alerts you to a dangerous situation. Failure to avoid this situation can result in minor or medium injury.
 A0011192-EN	NOTICE This symbol contains information on procedures and other circumstances, which do not result in personal injury.

1.2.2 Electrical symbols

Symbol	Meaning
 A0011197	Direct current A terminal at which DC voltage is present or through which direct current flows.
 A0011198	Alternating current A terminal at which alternating voltage is present or through which alternating current flows.
 A0017381	Direct and alternating current <ul style="list-style-type: none"> ▪ A terminal to which alternating voltage or DC voltage is applied. ▪ A terminal through which alternating current or direct current flows.
 A0011200	Ground connection A grounded terminal which, as far as the operator is concerned, is grounded via a grounding system.

1.2.3 Symbols for certain types of Information

Symbol	Meaning
 A0011182	Permitted Indicates procedures, processes or actions that are permitted.
 A0011183	Preferred Indicates procedures, processes or actions that are preferred.

Symbol	Meaning
 A0011184	Forbidden Indicates procedures, processes or actions that are forbidden.
 A0011193	Tip Indicates additional information.
 A0011194	Reference to documentation Refers to the corresponding measuring device documentation.
 A0011195	Reference to page Refers to the corresponding page number.
1., 2., 3.,...	Series of steps
	Result of a series of actions
 A0013562	Help in the event of a problem
 A0015502	Visual inspection

1.2.4 Symbols in graphics

Symbol	Meaning
1, 2, 3, ...	Item numbers
A, B, C, ...	Views
A-A, B-B, C-C,..	Sections
 A0013441	Flow direction

1.3 Documentation

For an overview of the scope of the associated documentation, refer to the following:

- *W@M Device Viewer*: enter the serial number from the nameplate (www.endress.com/deviceviewer).
- *Endress+Hauser Operations App*: enter the serial number from the nameplate or scan the 2-D matrix code (QR code) on the nameplate.

1.4 Registered trademarks

Applicator

Registered or registration-pending trademark of the Endress+Hauser Group

Autotex®

Registered trademark of MacDermid Autotype Limited, Wantage, UK

DuploCOLL®

Registered trademark of Lohmann GmbH, Neuwied, Germany

Microsoft®

Registered trademark of the Microsoft Corporation, Redmond, Washington, USA

2 Basic safety instructions

2.1 Requirements for personnel

The personnel for installation, commissioning, diagnostics and maintenance must meet the following requirements:

- Personnel must be trained, qualified specialists with a relevant qualification for the specific functions and tasks.
- Personnel must be authorized by the plant operator.
- Personnel must be familiar with federal/national regulations.
- Before starting work, personnel must read and understand the instructions in the manual, supplementary documentation and certificates (depending on the application).
- Personnel must follow instructions and comply with general policies.

Operating personnel must meet the following requirements:

- Operating personnel must be instructed and authorized according to the requirements of the task by the facility's operator.
- Operating personnel must follow the instructions in the manual.

2.2 Designated use

Application and fluids

Only use the measuring device described in these Operating Instructions to measure the concentration of liquids.

Only use the measuring device within the limits specified in the technical data and for the specific concentration app.

To ensure that the measuring device remains in proper condition for the operation time:

- ▶ Only use the measuring device for fluids to which the process-wetted materials are sufficiently resistant.

Incorrect use

Non-designated use can compromise safety. The manufacturer is not liable for damage caused by improper or non-designated use.

Other risks

Hot media can present a burn hazard

- ▶ In the case of high fluid temperatures, ensure protection against contact to prevent burns.

Risk of injury when changing the fluid

- ▶ The temperature of the sensor may not exceed the flash point of the new liquid under measurement.
- ▶ Clean thoroughly to remove all residue of the previous liquid and avoid unwanted chemical reactions. When cleaning, make sure to use appropriate personal protection equipment.

2.3 Occupational safety

When working on and with the measuring device:

- ▶ Wear the required personal protective equipment according to federal/national regulations.

2.4 Operational safety

Risk of injury

- ▶ Operate the measuring device only if it is in proper technical condition, free from errors and faults.
- ▶ The operator is responsible for the trouble-free operation of the device.

2.5 Product safety

This measuring device is designed in accordance with good engineering practice to meet state-of-the-art safety requirements, has been tested, and left the factory in a condition in which it is safe to operate. It meets general safety standards and legal requirements. It also complies with the EU directives listed in the device-specific EU Declaration of Conformity. Endress+Hauser confirms this by affixing the CE mark to the device.

2.6 IT security

We only provide a warranty if the measuring device is installed and used as described in the Operating Instructions.

IT security measures, which provide additional protection for the measuring device and device data transfer, must be implemented by the operators themselves in line with their security standards.

NOTICE

Spread of malicious software

The computer recognizes the transmitter as a mass storage medium. Because of this, malware that may be on the computer can potentially spread.

- ▶ Ensure suitable security measures are taken, such as the use of anti-virus software.

3 Product description

3.1 Product design

The measuring device consists of a mobile sensor and a mobile transmitter. The following additional components are included in the standard delivery package:

- Connecting cable
- USB cable
- USB charger
- Carrying case
- Printed copy of the Operating Instructions in the form of a Quick Start Guide
- Operating Instructions on a CD-ROM
- At least one concentration app and operating tool on a CD-ROM and on mass storage medium of transmitter.

The measuring device uses concentration apps, which are individually tailored to the measurement task and encoded to work only with the serial number of a specific transmitter. In the measuring device, each concentration app is located in a measuring point.

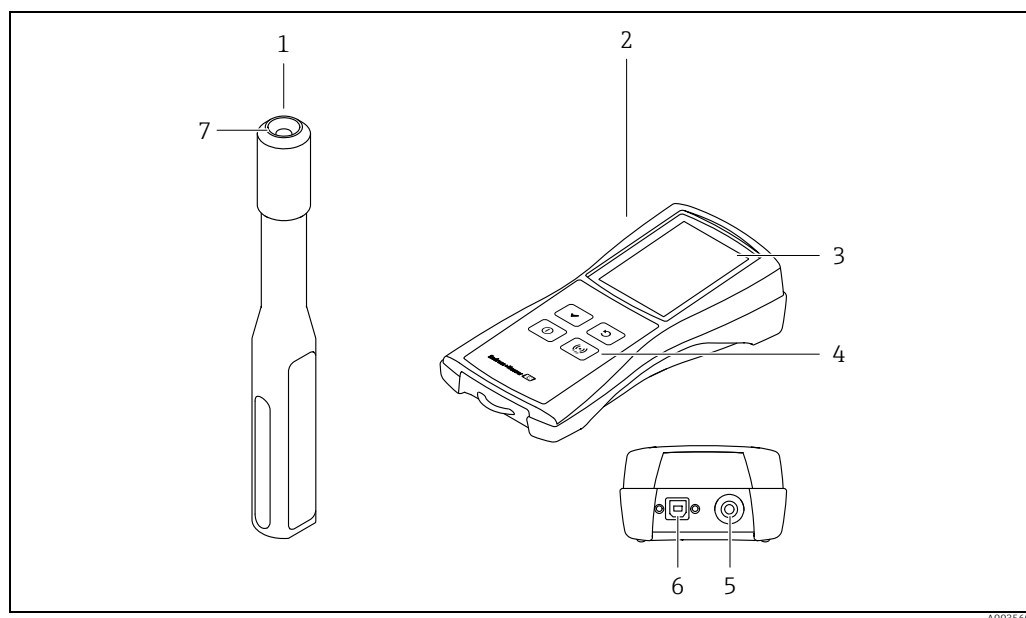



Fig. 1: Key components of the measuring device

- | | |
|---|--|
| 1 | Mobile sensor |
| 2 | Mobile transmitter |
| 3 | Local display (touch screen) |
| 4 | Operating keys (membrane keypad) |
| 5 | Connection for connecting to the sensor |
| 6 | USB interface for charging the battery (BCv1.2 standard) and for digital data transmission to the computer |
| 7 | Connection for connecting to the transmitter |

3.2 Concentration apps, measuring points

A concentration app contains specific settings for the measurement of a certain liquid and, along with the measured sensor signals, is used as the basis for calculating the concentration. Endress+Hauser provides a separate concentration app for each liquid.

A list of the available concentration apps is provided in the Applicator → 48. If you require a concentration app that is not available in the standard settings, Endress+Hauser requires a sample of the fluid to create the concentration app. Every transmitter can use a maximum of 150 concentration apps.

To be able to use a concentration app on the measuring device, the user must first save the desired concentration app in a measuring point using the operating tool. The measuring point can then be uploaded to the measuring device →  25. The same concentration app can be used for several measuring points.

Concentration apps are individually encoded to work only with the serial number of a specific transmitter. The transmitter in service uses the serial number saved in the .Imp or .lmf file to check whether the concentration app has been specifically configured for use with this transmitter. If this is not the case, it is not possible to add the concentration app.

4 Incoming acceptance and product identification

4.1 Incoming acceptance

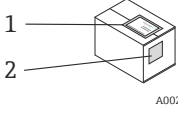
Is the order code on the delivery note (1) identical to the order code on the product sticker (2)?		<input type="checkbox"/>
Is the measuring device undamaged?		<input type="checkbox"/>
Do the data on the nameplate match the ordering information on the delivery note?		<input type="checkbox"/>
CD-ROM with "Teqwave Mobile Viewer" operating tool and concentration apps		<input type="checkbox"/>
Is a CD-ROM provided with the Technical Documentation (depends on device version) and documents?		<input type="checkbox"/>



- If one of the conditions is not satisfied, contact the Endress+Hauser Sales Center.
- The Technical Documentation is available on the Internet or via the Endress+Hauser Operations App →  10.

4.2 Product identification

The following options are available for the identification of the measuring device:

- Using the nameplate on the transmitter
- Using the order code with a breakdown of the device features on the delivery note.
- Enter the serial numbers from the nameplates in *W@M Device Viewer* (www.endress.com/deviceviewer): all the information about the measuring device is displayed.
- Enter the serial number from the nameplate into the *Endress+Hauser Operations App* or scan the 2-D matrix code (QR code) on the measuring device with the *Endress+Hauser Operations App*: all the information about the measuring device is displayed.

4.2.1 Nameplate

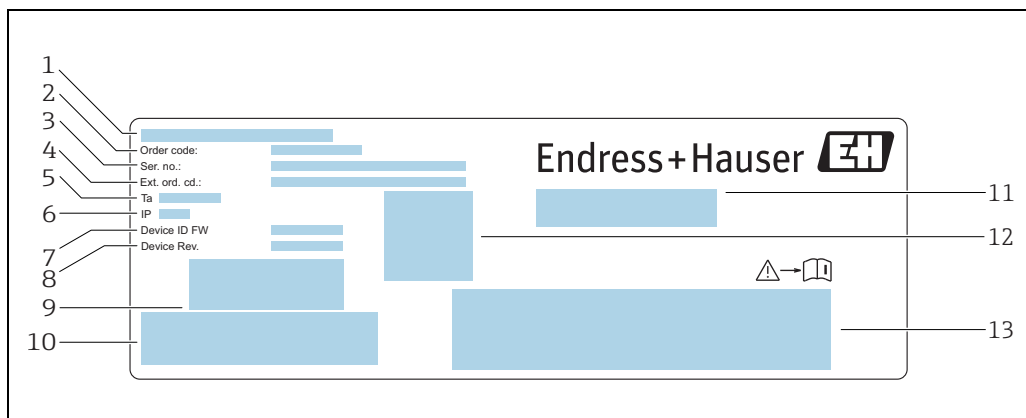

A0035638

Fig. 2: Example of a nameplate on a transmitter

- 1 Place of manufacture
- 2 Order code
- 3 Serial number (Ser. no.)
- 4 Extended order code (Ext. ord. cd.)
- 5 Permitted ambient temperature (T_a)
- 6 Degree of protection
- 7 Firmware version (Device ID FW) ex-works
- 8 Device version (Device Rev.) ex-works
- 9 Barcode for internal use
- 10 Barcode for internal use
- 11 Name of the measuring device
- 12 2D matrix code with serial number
- 13 Space for approvals and certificates

4.2.2 Symbols on the measuring device

Symbol	Meaning
	WARNING This symbol alerts you to a life-threatening situation. Failure to avoid this situation can result in serious or fatal injury.
	Reference to documentation Refers to the corresponding measuring device documentation.

A0011194

5 Storage and transport

5.1 Storage conditions

Observe the following notes for storage:

- Store in the original packaging to ensure protection from shock.
- Protect from direct sunlight to avoid unacceptably high surface temperatures.
- Store in a dry and dust-free place.
- Do not store outdoors.

Storage temperature →  51.

5.2 Transporting the product

- Transport the measuring device to the measuring point in the original packaging.
- Use the carrying case supplied to prevent the device from being switched on unintentionally.
- Do not remove protection caps mounted on connection points.
- When shipping the measuring device, the battery may not be more than 30% charged.
- When shipping, comply with Special Regulation SV 188 (transportation of lithium batteries).

5.3 Packaging disposal

All packaging materials are environmentally friendly and 100% recyclable: box in accordance with European Packaging Directive 94/62EC.

6 Electrical connection

6.1 Connection conditions

6.1.1 Requirements for connecting cables and chargers

Connecting cable between sensor and transmitter

Only use the cable supplied.

The connecting cables and chargers provided by the customer must fulfill the following requirements.

Electrical safety

National regulations and standards apply.

USB cable

Cable type	USB 2.0, Type A to Type B
Cable length	Max. 2 m (6.56 ft)
Approval	UL 2725

USB charger

Connection	USB socket Type A, as per BCv1.2 standard
Supply voltage	5 V
Charging current	1 A
Overload protection	Yes
Short-circuit proof	Yes
Power	6 W
Charge temperature	+10 to +40 °C (+34 to +104 °F)

6.2 Connecting the measuring device

6.2.1 Connecting the connecting cable

Connect the sensor to the transmitter only using the connecting cable supplied.

NOTICE

Damage to the measuring device

Damaged cables can impact the functional integrity of the measuring device.

- ▶ Do not bend or shorten the connecting cable.
- ▶ Do not remove the plug of the connecting cable.
- ▶ Replace damaged or broken cables immediately.
- ▶ Insert the connectors of the connecting cable into the socket at the position indicated until they engage with a click.



Red dots on the connectors indicate the position. The two connections on the cable are not identical - one is only designed for the sensor and the other is designed exclusively for the transmitter.

6.2.2 Connecting the USB cables

NOTICE



Spread of malicious software

The computer recognizes the transmitter as a mass storage medium. Because of this, malware that may be on the computer can potentially spread.

- ▶ Ensure suitable security measures are taken, such as the use of anti-virus software.

The USB port of the measuring device is used for the following:



- To charge the battery via the computer or USB charger
- To transmit data to the computer
- To establish the connection to the "Teqwave Mobile Viewer" operating tool

 If connecting to the USB charger: use the USB charger supplied with the device. If using third-party products: ensure compliance with the charger specifications →  13.

 If connecting to the computer: the measuring device cannot perform any measurements during this time.

Connecting the USB cables

- ▶ Connect the measuring device with the computer (switched on) or the USB charger via the USB cable.
 - ↳ The battery symbol flashes while the measuring device is charging.
 - ↳ If the device is connected to the computer, the computer recognizes the measuring device as a mass storage medium.
 - ↳ Possible to connect to the "Teqwave Mobile Viewer" operating tool →  19.

 If the battery symbol does not flash, the battery is already fully charged or the charging temperature is outside the permitted range →  13.

6.3 Post-connection check

Are the measuring device and the cables undamaged (visual inspection)?	<input type="checkbox"/>
Do the cables and charger used comply with the requirements (→  13)?	<input type="checkbox"/>
Do the mounted cables have adequate strain relief?	<input type="checkbox"/>
Are all the connectors firmly seated?	<input type="checkbox"/>
If the battery is charged: is the device ready for operation and does anything appear on the local display?	<input type="checkbox"/>

7 Operating options

7.1 Overview of the operating options

The measuring device can be operated and configured in the following ways:

- Operation via the local display (mobile transmitter)
- Measured data configured and read out via the "Teqwave Mobile Viewer" operating tool supplied

7.2 Access to the measuring device via the local display

The measurement procedure is started via the local display. The measuring device is configured and the measured values of the measuring device are read out using the operating tool supplied.

7.2.1 Measuring point selection (startup screen)

After starting the measuring device, the screen appears where you can select the measuring point. Use the back/repeat key on the membrane keypad to return to the measuring point selection. Measuring points can be organized into groups and subgroups.

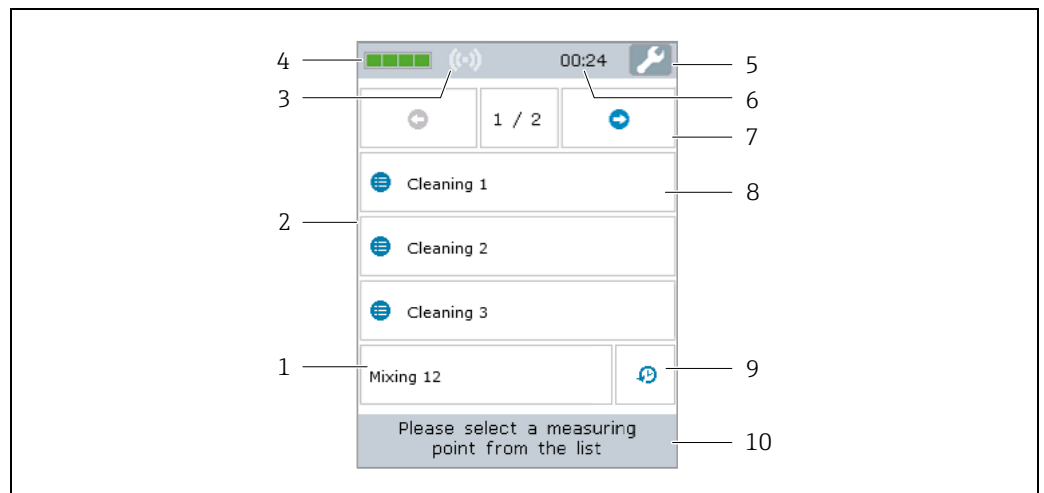

Fig. 3: Example: measuring point selection (startup screen)

- 1 Measuring point
- 2 Measuring point selection and measurement display area → 16
- 3 RFID signal indicator for automatic measuring point detection (RFID is currently not available)
- 4 Battery charge status
- 5 Access settings for date and time → 26
- 6 Clock
- 7 Scroll function
- 8 Measuring point group/subgroup
- 9 Shows measuring history
- 10 Information/instructions

Scroll function

The scroll function appears as of six groups or six measuring points.

Measuring point group/subgroup

Organizing measuring points into groups gives users a better overview and allows users to find the measuring points they need more quickly. Measuring points can be organized into groups using the operating tool.

Measuring point

The operating tool allows users to create measuring points, organize the measuring points into groups and subgroups and load them to the measuring device.

7.2.2 Measurement display area

During a measurement, the measuring condition screen is shown on the local display. If the measured values remain within the measuring range limits (green area) for 20 seconds and the measuring conditions are fulfilled, the measurement result screen will be shown on the local display. If the measured values are outside the measuring range limits for longer than 10 seconds, or if the measuring conditions are not fulfilled for longer than 3 minutes, the error message screen will be shown on the local display.

Measuring condition screen

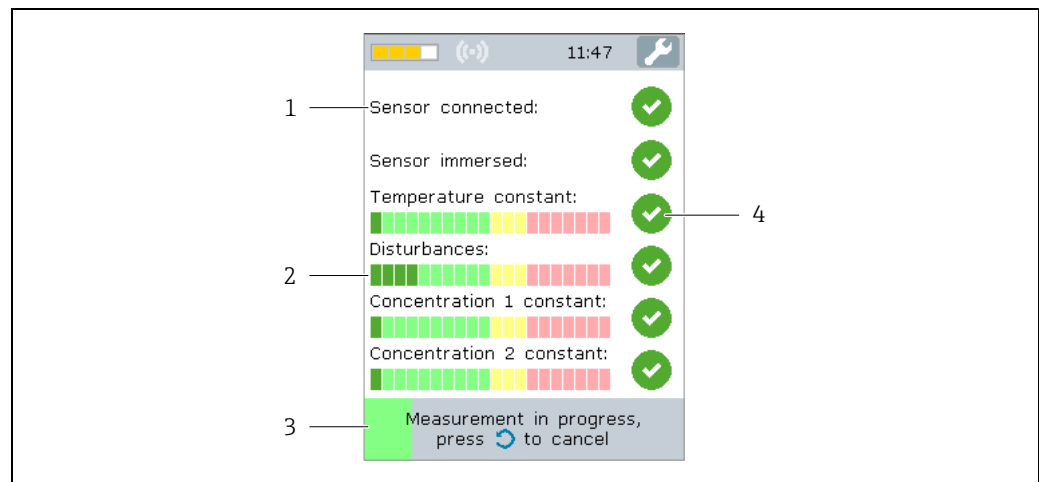

Fig. 4: Example: automatic measuring condition check

- 1 Test criterion
- 2 Indicator: signals whether value of test measurements is within or outside measuring range limits
- 3 Indicates progress of test measurement
- 4 Test status indicator: condition satisfied, condition not satisfied, criterion not yet tested

Measurement result screen

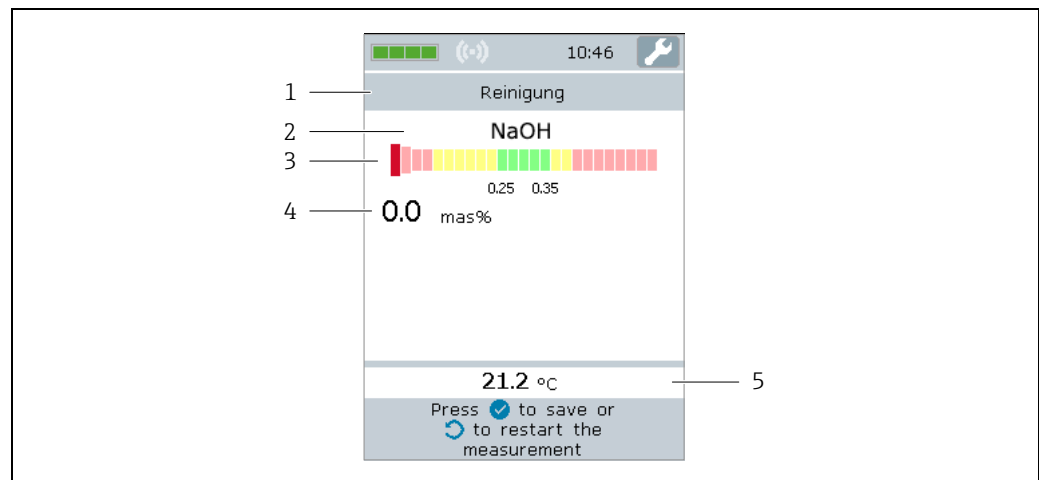

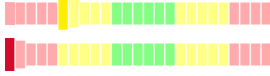

Fig. 5: Measurement result

- 1 Name of the measuring point
- 2 Name of the measured concentration
- 3 Graphic representation of the measured value with tolerance limits
- 4 Measured concentration, averaged over the last 10 seconds
- 5 Measured temperature, averaged over the last 10 seconds

Graphic measured value representation

With the graphic representation of the measured values, the measuring device presents the measured values in relation to the limit values. The configured limit values can be viewed with the operating tool → 31.

Display	Description
	Green area Measured value is within the valid range.
	Yellow or red area Measured value is outside the valid range. The measuring device can issue a dosing recommendation for a concentration app if the function is enabled for the measuring point in question.

Error message screen

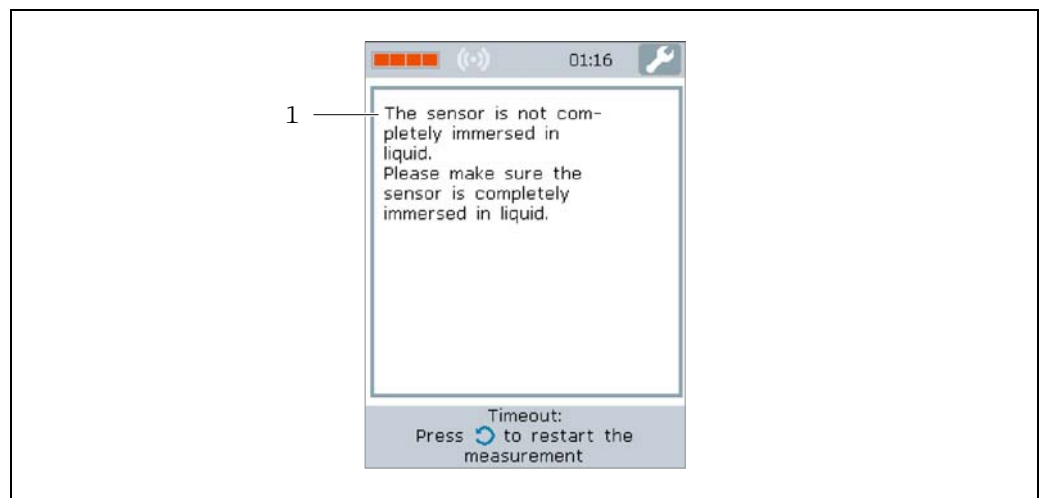





Fig. 6: Error screen

1 Description of the problem and possible causes. Overview of all error messages → 42

7.2.3 Information area/help text

The local display displays "Help" for every screen. This help describes the next step and helps users to perform a measurement and analyze the measurement results.

7.2.4 Operating keys

Key	Meaning
	On/Off button <ul style="list-style-type: none"> Press the button briefly to switch the device on/off. Press the button for longer to reset the device.
	Confirm key Confirm actions.
	Back/repeat key Go back one step or repeat the measurement.
	RFID key (RFID is currently not available) When this key is pressed, the startup screen appears.

7.3 Access to the measuring device via the operating tool

The measuring device is configured via the "Teqwave Mobile Viewer" operating tool. In addition, the operating tool enables the reading and graphic representation of the measured values.

Supported functions:

- Read, display, delete and export measured values saved in the transmitter
- Create report of saved measured values
- Read out and create report of results of functional tests
- Configure the operating language of the transmitter
- Add, delete and group measuring points
- Create new measuring points
- Create and save device configurations (Configuration manager)

7.3.1 System requirements

Hardware

Connecting cable	USB 2.0, Type A to Type B
Computer	USB port
Display	Recommended screen resolution: min. 1024 x 768 pixels

Computer software

Recommended operating system	Microsoft Windows 7 or higher
Drivers	USB driver

7.3.2 Software installation

Installing the "Teqwave Mobile Viewer" operating tool"

1. Close all applications.
2. Insert the CD-ROM supplied into the drive.
3. Double-click the "setup.exe" file to start the installation.
4. Follow the instructions in the installation window.

7.3.3 Establishing a connection

NOTICE

Spread of malicious software

The computer recognizes the transmitter as a mass storage medium. Because of this, malware that may be on the computer can potentially spread.

- ▶ Ensure suitable security measures are taken, such as the use of anti-virus software.



The device detects if the computer's security software writes encrypted files to an externally connected device. In this case, it is not possible to connect the measuring device to the computer, and the following error message appears: "A security software (firewall, antivirus software, etc.) blocks the measuring device. Try reconnecting the measuring device. Contact your IT administrator if the error still persists."



When you start the operating tool for the first time, you are asked to specify the working directories where device configurations, concentration apps and measuring points will be saved. If nothing is selected here, the operating tool creates standard directories. This can be changed subsequently → 26.

1. Switch on the measuring device.
2. Connect to the computer with the USB cable.
3. Start the "Tegwave Mobile Viewer" operating tool.
4. Via quick navigation, press the "Search for new devices" button to refresh the selection.
 - ↳ The device list is refreshed and the recently connected measuring device can be selected from the list via its serial number.
5. In the "Device" selection field, select the serial number of the connected measuring device.
 - ↳ The measuring device and operating tool are connected.

7.3.4 User interface

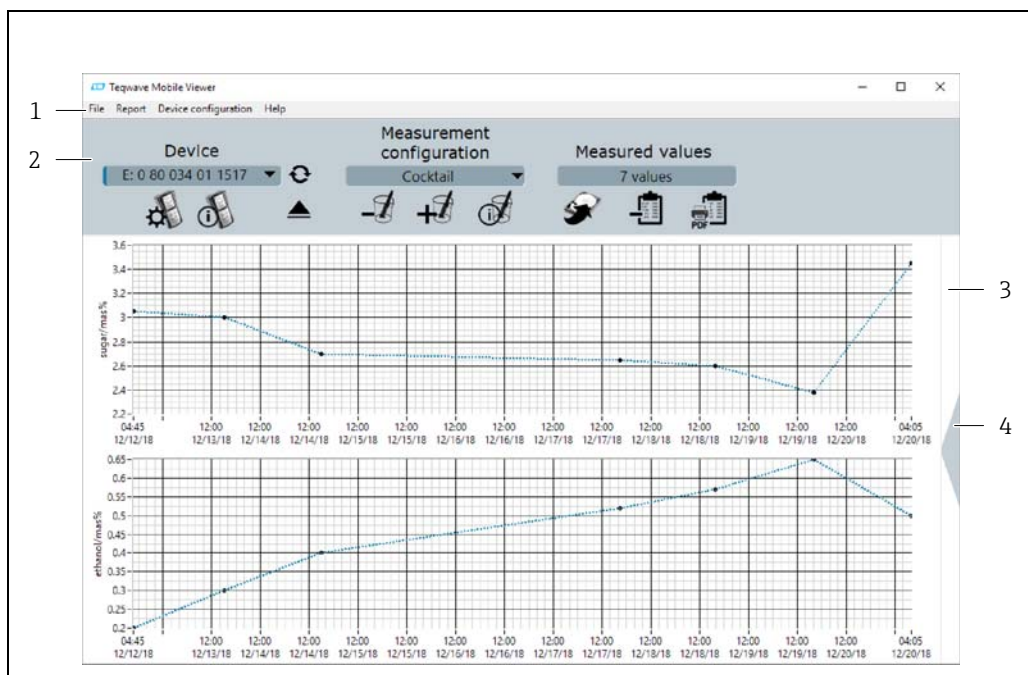

Fig. 7: User interface

- 1 Menu bar
- 2 Quick navigation
- 3 Graph view or graph/table view
- 4 Switch between graph view and graph/table view

7.3.5 Menu bar

File menu

Functions for communicating with the measuring device, for retrieving and saving measured data that are saved in the measuring device, and for importing new measuring points or concentration apps as well as editing a measuring point setting stored on the computer.

Menu	Submenu/description
Save data from selected measuring point	Save the data of the selected measuring point to the computer.
Save data from all measuring points	Save the data of all the measuring points from the selected measuring device to the computer.
Load data	Read in the data of a measuring point from the data storage location.
Import measuring points/concentration apps	Import the measuring point (.Imp file), concentration app (.Imf file) or device configuration (.config file) to the operating tool.
Edit local measuring points	Edit the measuring point setting stored on the computer.
Search for new devices	Refresh the device list when a new measuring device has been connected to the computer via the USB port.
Eject device	Disconnect the measuring device that is selected in the operating tool from the operating tool and the operating system.
Settings	<ul style="list-style-type: none"> ▪ Language: select the language of the operating tool. ▪ Working directory: select the storage location for device configurations, concentration apps and measuring points.
Exit	Exit the program.

Report menu

Functions for created a report of the measured values.

Menu	Description
Settings	Specify the settings for creating the report.
Create	Create a report, in PDF format, for measured values of the selected measuring point or for a functional test that has been performed.
Functional test	Display the results of the functional test for the selected measuring device in the operating tool.

Device configuration menu

Functions for configuring the measuring device.

Menu	Submenu/description
Measuring point	<ul style="list-style-type: none"> ▪ Information: open the "Measuring point information" window. Call up measuring point information for the selected measuring point. This includes information such as the concentration app used, the tank volume, offset concentration, concentrate density and measuring ranges. ▪ Organizing: open the "Organize measuring points" window. Add or remove available measuring points to/from the measuring device and organize them into groups. ▪ Edit: Edit selected measuring point. ▪ Delete: Remove the selected measuring point from the measuring device. ▪ New: Create a new measuring point.
Measured values	<ul style="list-style-type: none"> ▪ Delete (current): delete the measured values of the selected measuring point from the measuring device. ▪ Delete (all): delete all the measured values from the selected measuring device.

Menu	Submenu/description
Settings	<ul style="list-style-type: none"> ▪ Language: select the language of the local display.
Update firmware	Update the transmitter firmware.
Configuration manager	Save the device settings for the measuring point organization and language in a configuration file.

Help menu

Information about the system and device.





Menu	Description
Operating Instructions	Open the Operating Instructions in the standard PDF Viewer.
System information	Open the system information.
About	Open the software and manufacturer information and the legal information.

7.3.6 Quick navigation

Quick navigation allows users to directly access frequently used functions.



Quick navigation in the device

Functions for connecting to the measuring device and for language settings. Use the "Device" selection field to select the measuring device which is to be connected with the computer.

Button	Description
	Search for new devices Refresh the device list after connecting a device with the computer.
	Eject device Disconnect the measuring device that is currently selected from the operating system.
	Call up the device settings Set the language of the measuring device.
	Call up the device information Display device information, such as the firmware, serial numbers and language settings for the selected measuring device.



Quick navigation for measuring points

Functions for editing the measuring point organization. Select the measuring point to be edited using the "Measuring point" selection field.

Button	Description
	Delete the measuring point Delete the selected measuring point from the measuring device.
	Add or organize measuring points Open the "Organize measuring points" window. Add or remove available measuring points to/from the measuring device and organize them into groups.
	Measuring point information Open the "Measuring point information" window. Call up the measuring point information. This includes information such as the concentration app used, the tank volume, offset concentration, concentrate density and measuring ranges.

Quick navigation for measured values

Functions for saving measured values and creating reports. The "Measured values" view box displays the number of measuring points.

Button	Description
	Save data from selected measuring point Save the data of the selected measuring point to the computer.
	Delete measured values (of selected measuring point) Delete the measured values of the selected measuring point from the measuring device.
	Create report Create a report, in PDF format, for measured values of the selected measuring point or for a functional test that has been performed.

7.3.7 Graph/table view

The operating tool presents the concentration measured data in graph format on the home page. It is possible to change to a combined graph and table view. The table view also contains the temperature measured data as well as information on additional dosing.

Structure of the graph view

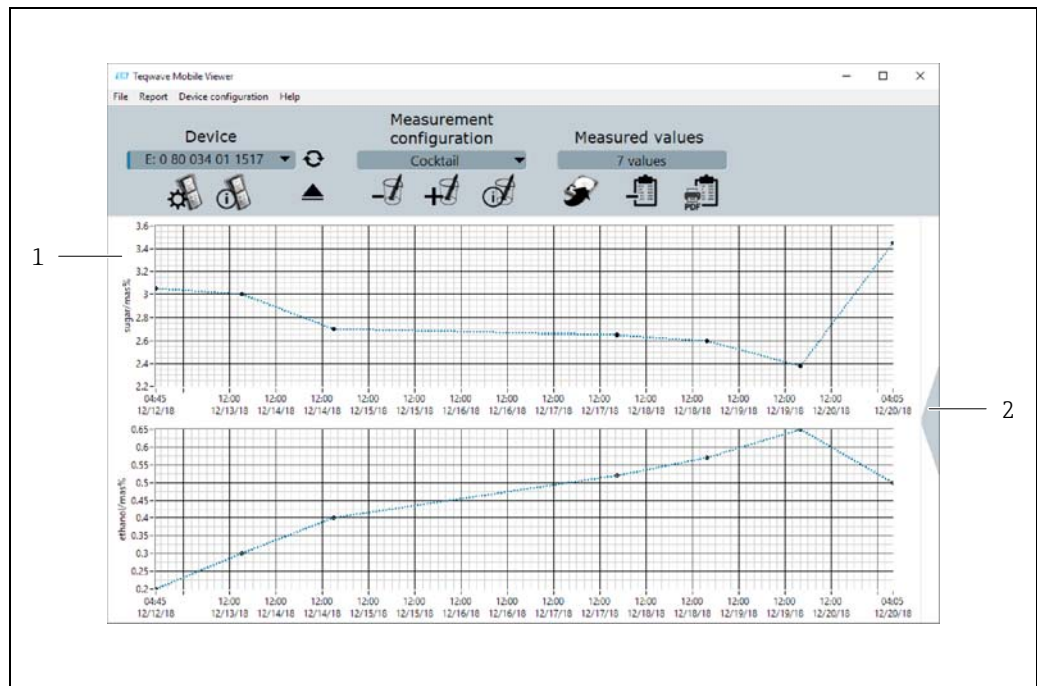

Fig. 8: Graph view

- 1 Graph view of the measured values (measured variables: concentration 1-2)
- 2 Change to graph/table view

Structure of the graph/table view

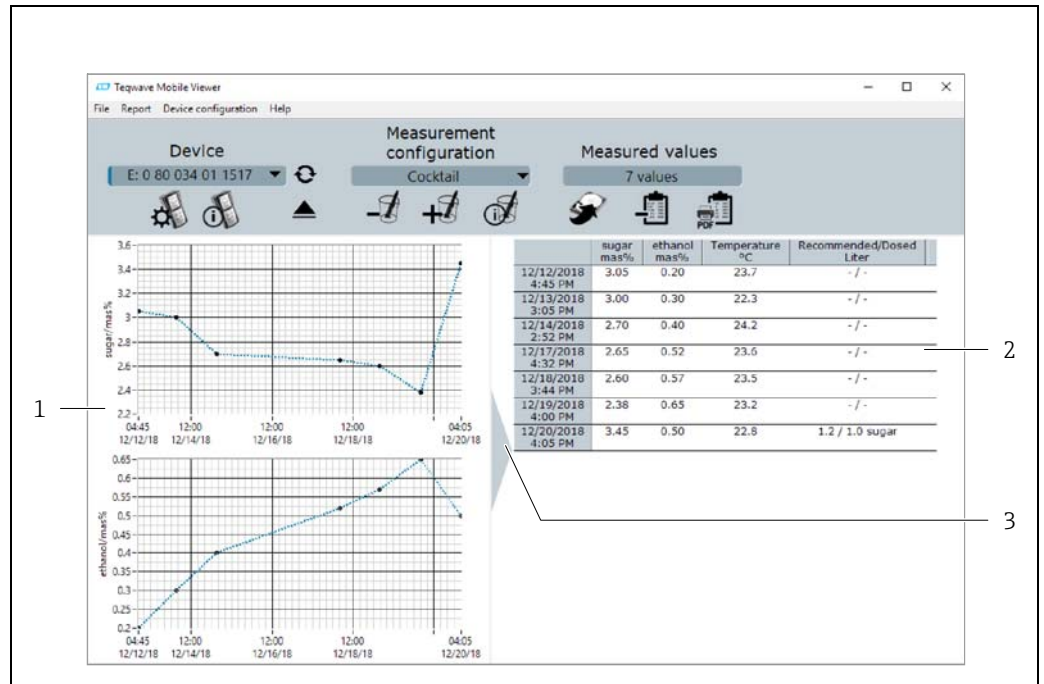

Fig. 9: Graph/table view

- 1 Graph view of the measured values (measured variables: concentration 1-2)
- 2 Table view of the measured values (measured variables: concentration 1-2 and temperature, as well as additional dosing quantity and recommended additional dosing)
- 3 Switch to graph view

General buttons

Button	Description
	"Apply" button Confirm entries, save to measuring device.
	"Save" button Confirm entries and save. The changes do not affect the connected measuring device.
	"Cancel" button Cancel the operation and close the window.
	"Close" button Close the window.

8 Commissioning

NOTICE

Damage to the touch surface

Sharp objects, electrostatic discharge, water and the use of pens not designed for touch screens, such as standard pencils, can cause a touch screen malfunction or damage the touch surface.

- ▶ Do not use sharp objects to operate the touch screen.
- ▶ Make sure the touch surface does not come into contact with other devices.
- ▶ Make sure the touch surface does not come into contact with water.
- ▶ Only use your finger or a specially designed stylus pen to operate the touch surface.

NOTICE

Damage to the membrane keypad

Sharp objects, excessively high pressure, or water can cause the membrane keypad to malfunction or damage the keypad.

- ▶ Do not use sharp objects to operate the touch screen.
- ▶ Do not exert excessive pressure on the membrane keypad.



8.1 Function check

Perform the post-connection checks before commissioning the device.

- Checklist for "Post-connection check" →  14.

8.2 Charging the battery



The measuring device is powered by a built-in battery. The battery is recharged with the charger or computer via the USB port.

 If connecting to the USB charger: use the USB charger supplied with the device. If using third-party products: ensure compliance with the charger specifications →  13.

 If connecting to the computer: the measuring device cannot perform any measurements during this time.

Charging the battery

- ▶ Connect the measuring device with the computer (switched on) or the USB charger via the USB cable.
 - ↳ The battery symbol flashes while the measuring device is charging.

 If the battery symbol does not flash, the battery is already fully charged or the charging temperature is outside the permitted range →  13.

8.3 Switching on the measuring device

- ▶ Once the battery has been charged successfully, switch on the measuring device with the On/Off button.
 - ↳ The local display of the measuring device starts booting.

 If an error message or nothing appears on the local display, perform Diagnostics and troubleshooting →  42.

8.4 Configuring the measuring device







The user must configure the measuring device before it can be used. This also includes the creation of the measuring points that are required for the measurement. This is done using the operating tool. Users can set the date, time and operating language via the local display.

8.4.1 Creating a measuring point and loading it to the measuring device

To be able to use a concentration app on the measuring device, the user must first save the desired concentration app in a measuring point using the operating tool. Afterwards, the user must load the measuring point to the measuring device. It is possible to use the same concentration app for multiple measuring points.

Creating a measuring point and loading it to the measuring device

Prerequisite

- The "Tegwave Mobile Viewer" operating tool is installed →  18
 - The measuring device is connected to the operating tool →  19
1. Using the operating tool, save the concentration app in the working directory of the operating tool with the "Import measuring points/concentration app" function →  26.
 2. Create and configure the measuring point →  27.
 3. Edit the measuring point if necessary →  28.
 4. Load the measuring point to the measuring device via the "Organize measuring points" function →  29.

8.4.2 Setting the operating language

The transmitter operating language is set via the operating tool or via the local display.

 The language of the operating tool is selected via "File" → "Settings" → "Language". The same range of options are available.

Navigation using the local display

Settings menu → "Language"

Navigation using the operating tool

Menu "Device configuration" → "Settings" → "Language"

 Once the user has selected the language, the operating tool communicates the language setting to the transmitter.

Parameter	Procedure	Selection/input	Factory setting
Language	Tap to select the language.	<ul style="list-style-type: none"> ■ German ■ English ■ French ■ Italian ■ Spanish 	English

8.4.3 Setting the date and time

The date and time of the transmitter are set exclusively via the local display.

Setting the date and time

1. Tap the Settings symbol on the touch screen of the measuring device.
 - ↳ The settings for changing the date and time open.
2. Tap the "Date" or "Time settings" button.
 - ↳ A numeric editor opens.
3. Enter the desired date or time and tap the Enter button to confirm.
 -  To enter the day, month and year for the desired date, first tap "DD", "MM" and "YY", respectively, in the first line of the numeric editor. To specify the hours, minutes and seconds of the desired time, first tap "hh", "mm" and "ss", respectively, in the first line of the numeric editor.
 - ↳ The desired date or time is set.

8.5 Advanced settings via the operating tool

8.5.1 Specifying the working directories



The storage locations for device configurations, concentration apps and measuring point data records are changed via the **Working directories** function.

Specifying the working directories

1. Select the menu "File" → "Settings" → "Working directories".
 - ↳ The "Working directories" window appears.
2. Click "Choose" to define the storage location. The following options are available:
 - Select the directory for device configurations
 - Select the directory for concentration apps
 - Select the directory for measuring points
 - ↳ The "Choose folder for measured values" window appears.
3. Select the desired working directory on the computer and select "Choose" to confirm.
4. Click "Save" to confirm your entries.
 - ↳ The selected working directories are specified.

8.5.2 Importing the measuring point, concentration app or device configuration

A measuring point, a concentration app or a device configuration is imported via the **Import measuring points/concentration apps** function. It is necessary to import a concentration app in order to create and add measuring points when commissioning the device for the first time, for example. A device configuration contains a user-definable measuring point organization and the language setting. The operating tool saves the new data records to the specified "Measuring points", "Concentration apps" and "Device configurations" working directories.

-  Once a measuring point has been imported, the **Organize measuring points** function →  29 allows users to add the new measuring point to the measuring device. A concentration app that is not saved in a measuring point must be integrated into a measuring point with the **Create measuring point** function →  27 before it is added to the measuring device.

Importing the measuring point, concentration app or device configuration

1. Select the menu "File" → "Settings" → "Import measuring points/concentration apps".
↳ The "Import measuring points/concentration apps" window opens.
2. Select the desired .lmf file (concentration app), .Imp file (measuring point) or .config file (device configuration) and click "Import" to confirm.
↳ The operating tool copies the data records to the relevant working directory.

8.5.3 Creating a new measuring point

The **Create** function allows users to create and configure a new measuring point for the selected measuring device. Here, users can choose from the concentration apps pertaining to the measuring device. An offset can be configured for each concentration if necessary. If the "Dosage recommendation" check box is enabled, the measuring device displays a dosage recommendation if values stray outside the set limit values. This dosage recommendation requires additional settings. To ensure that the measuring point is available in the measuring device, add the measuring point to the measuring device afterwards with the **Organize** function → 29.

Creating a new measuring point

Prerequisite

- The measuring device is connected to the operating tool.
- The concentration app is in the working directory.

Navigation using the operating tool

Menu "Device configuration" → "Measuring point" → "Create"

- i** A new measuring point is configured in the "Create measuring point" window. The operating tool saves the new measuring point (.Imp file) in the working directory when the "Save" button is clicked → 26.

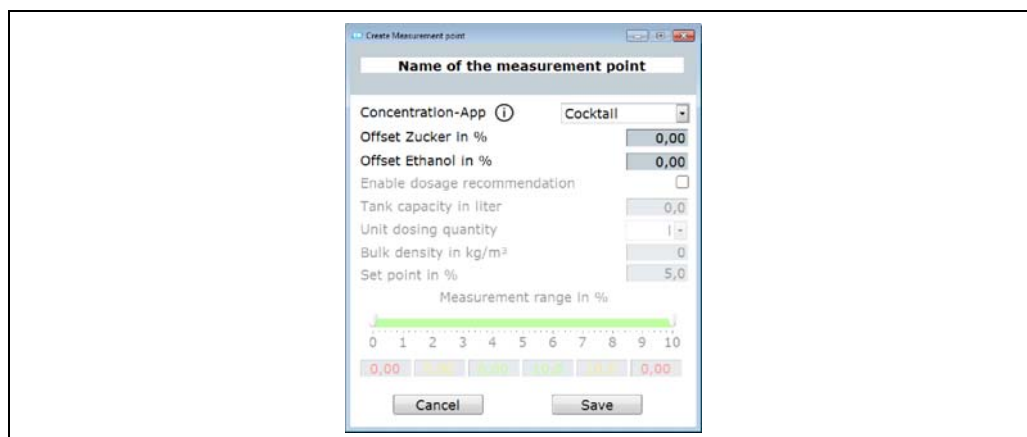

Fig. 10: Example: "Create measuring point" window

A0035683-EN

Overview of parameters with a brief description of the "Create measuring point" window

Parameter	Procedure	Selection/input	Factory setting
Name of the measuring point	Enter name of measuring point.	Any sequence of letters and characters, max. 39 characters.	-
Concentration app	Select the concentration app for the measuring point.	Users can choose from the concentration apps pertaining to the measuring device.	First concentration app in the list.
Offset [<i>concentration 1-2</i>] in %	Enter the value for the concentration offset.	Floating-point number with sign	0.00
Dosing recommendation	Enable the check box if the measuring device should display a dosing recommendation.	<ul style="list-style-type: none"> ■ Enabled ■ Disabled 	Disabled
Tank volume in liters	Specify the tank volume for calculating the dosing recommendation. If 0 is specified as the value, the measuring device displays a dosing recommendation that is calculated to 100 liters.	Positive decimal	0.0 l
Unit dosing quantity	Select the unit for the dosing recommendation.	<ul style="list-style-type: none"> ■ l ■ kg ■ lb ■ US.liq.gal 	1
Bulk density in kg/m ³	If the measured variable is a solid, enter the bulk density of the measured variable. If the measured variable is a liquid, enter the value 0 . In this case, the measuring device uses the density of the concentration app.	Positive decimal	0 kg/m ³
Target value [<i>concentration 1</i>] in %	Enter the target value of the concentration.	Positive decimal	Mean of the measurement range that is specified in the concentration app.
Measurement ranges [<i>concentration 1</i>] in %	Define limit values for which the measuring device displays a dosing recommendation if the limits are exceeded or undershot. There are two types of limit in the measuring device. These are displayed as a yellow range or red range.	Positive decimal	Depends on the measuring range that is specified in the concentration app.

8.5.4 Editing a measuring point

The **Edit measuring point** function allows you to edit the settings of an existing measuring point that is located on the selected measuring device. With the exception of the concentration app, all the settings of a measuring point can be modified. When the measuring point is saved, the measuring device creates a new measured value file (.csv file). The previous .csv file is simultaneously renamed to .old. The .old file can then be accessed via Windows Explorer.

Editing a measuring point

Prerequisite

- The measuring device is connected to the operating tool →  19

1. Select the measuring point you wish to modify in quick navigation.
2. Select the menu "Device configuration" → "Measuring point" → "Edit".
↳ The "Edit measuring point" window appears.
3. Edit the measuring point in the "Edit measuring point" window. Overview of parameters with a brief description →  28.

4. Click "Save" to save the changes.
 - ↳ The operating tool transfers the newly configured measuring point to the measuring device and overwrites the old settings.
 - ↳ If measured values were already saved using the old configuration, the measuring device creates a new .csv file and renames the file containing the old measured values to .old.

8.5.5 Organize measuring points

With the **Organize** function, it is possible to group several measuring points into a measuring point group, to delete measuring points from the measuring device and to add available measuring points to the measuring device. In addition, new measuring points can be created and edited.

 All the measuring points and measuring point groups are displayed in alphabetical order.

Structure of the "Organize measuring points" window

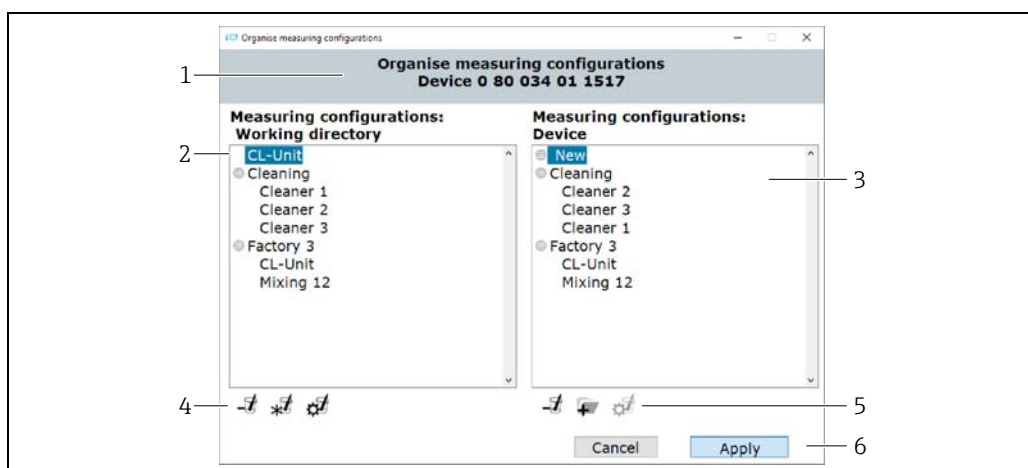





Fig. 11: Example: "Organize measuring points" window

- 1 Measuring device serial number
- 2 Measuring points available in the working directory
- 3 Measuring points added to the measuring device
- 4 Function buttons for editing the measuring points and measuring point organization in the working directory, description → 29
- 5 Function buttons for editing the measuring points and measuring point organization in the measuring device, description → 29
- 6 Transfer the measuring point organization to the measuring device

Function buttons

Button	Description
	Delete the measuring point or the measuring point group Delete the selected measuring point or measuring point group from the measuring device.
	Create a measuring point Open the "Create measuring point" window. Create a new measuring point → 27.
	Edit a measuring point Open the "Edit measuring point" window. Editing a selected measuring point → 27.
	Create the measuring point group Create a new measuring point group or subgroup.

Opening the "Organize measuring points" window

Prerequisite

- The measuring device is connected to the operating tool.
- ▶ Select the menu "Device configuration" → "Measuring point" → "Organize".
 - ↳ The "Organize measuring points" window appears.

Adding a measuring point to the measuring device

- ▶ Drag the measuring point or measuring point group from the left-hand window "Measuring points: working directory" and drop it into the right-hand window "Measuring points: device" at the desired position.

Adding a measuring point group or subgroup to the measuring device

 A maximum of one subgroup is permitted per measuring point group.

1. Click the Add button to add a new measuring point group or subgroup. Select the measuring point group beforehand in order to create a subgroup.
 - ↳ The measuring point group or subgroup appears at the top.
2. Assign a name to the measuring point group or subgroup.
 -  The name may only occur once in a level. A maximum of 30 characters are permitted.
 - ↳ The operating tool sorts the measuring point groups and subgroups in alphabetical order.

Deleting a measuring point or measuring point group from the measuring device

- ▶ Click the Delete button to delete a previously selected measuring point or measuring point group from the measuring device.

Transferring new measuring point organization to the measuring device

1. Click the "Apply" button to save the new measuring point organization in the measuring device.
 - ↳ The operating tool transfers the new measuring point organization to the measuring device and overwrites the old organization.
 - ↳ The measuring device is disconnected from the operating tool and computer.
2. Reconnect the measuring device with the operating tool to make the changes visible in the operating tool. Reconnect the USB cable to the computer for this purpose.

8.5.6 Measuring point information

The **Information** function displays the measuring point configuration of the selected measuring point.

Structure of the "Measuring point information" window

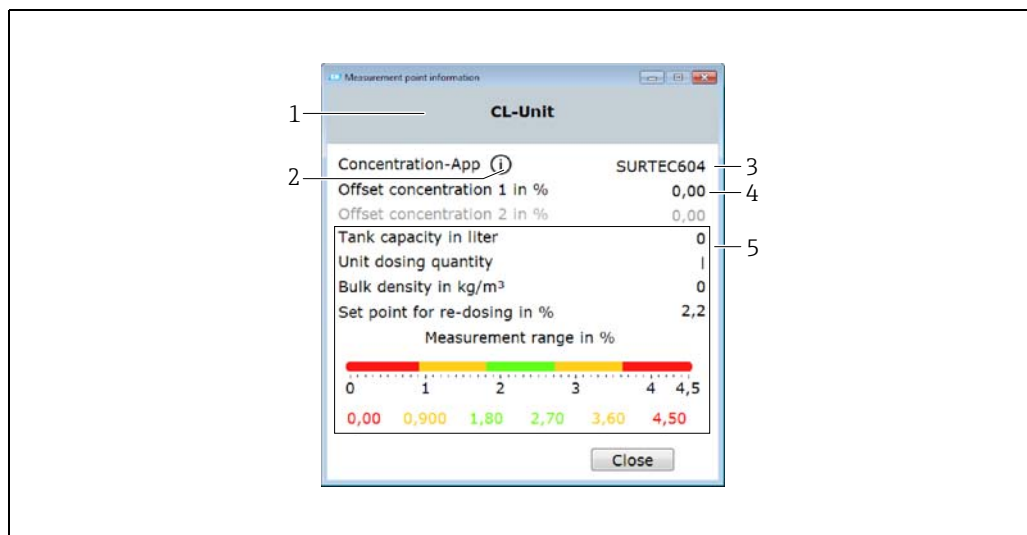

Fig. 12: Example: "Measuring point information" window

- 1 Name of the measuring point
- 2 See detailed information about the concentration app being used
- 3 Concentration app
- 4 Offset settings
- 5 Settings for the dosage recommendation

Opening the "Measuring point information" window

Prerequisite

- The measuring device is connected and the measuring point is selected
- ▶ Select the menu "Device configuration" → "Measuring point" → "Information".
 - ↳ The "Measuring point information" window appears.

Viewing the concentration app information

- ▶ Click the "Information" icon.
 - ↳ The "Concentration app information" window appears.

8.5.7 Configuration manager

The Configuration manager allows users to create multiple device configurations. A device configuration contains a user-definable measuring point organization and the language setting. This makes it possible to use the measuring device with different device configurations. For example, one device configuration can be limited to selected measuring points while another device configuration offers all the measuring points that are available. When organizing measuring points, users can choose from the measuring points pertaining to the measuring device.

It is only possible to change a device configuration via the operating tool. The operating tool can export selected device configurations, which makes it possible to transfer the measuring device containing multiple configurations to additional users. The measuring device user requires the operating tool to change the device configuration.

Structure of the "Configuration manager" window

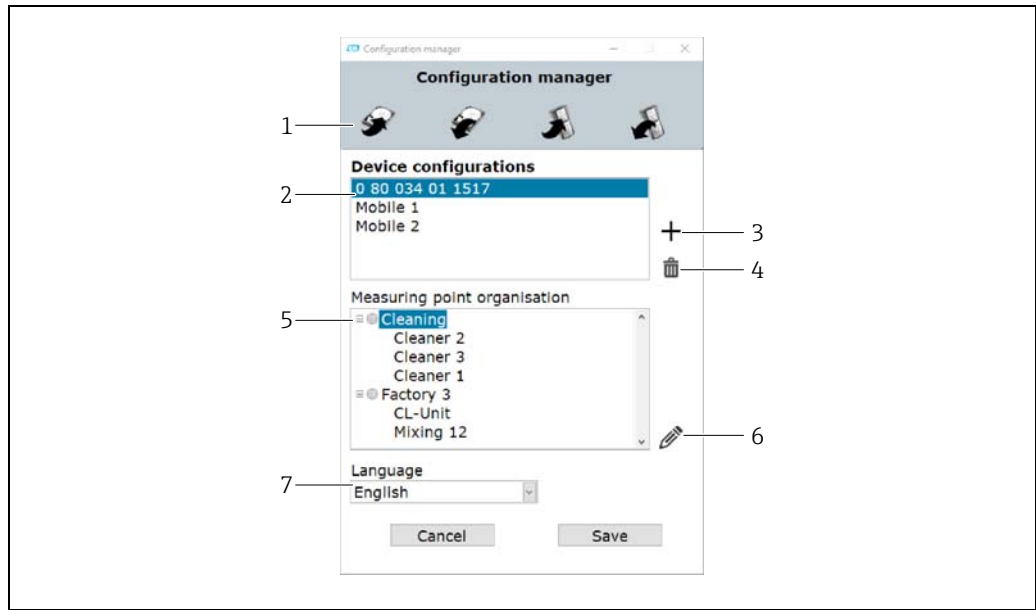





A0035688-EN

Fig. 13: Example: "Configuration manager" window

- 1 Function buttons
- 2 Device configurations available in the working directory
- 3 Add device configuration
- 4 Delete device configuration
- 5 Measuring point organization of the selected device configuration
- 6 Edit measuring point organization
- 7 Language setting for the selected device configuration

Function buttons

Button	Description
	Export device configurations Save all existing device configurations to the computer. The operating tool saves all configurations together to a .cfg file.
	Import device configurations from the computer Import device configurations stored in the .cfg file to the operating tool.
	Transfer the device configuration to the measuring device Save the selected device configuration to the measuring device.
	Import device configuration from measuring device Load the device configuration used in the measuring device in the operating tool. The operating tool saves the configuration to a .config file.

Opening the "Configuration manager" window

Requirements

- The operating tool is connected to the measuring device.
- ▶ Select the menu "Device configuration" → "Configuration manager".
 - ↳ The "Configuration manager" window appears and displays the device configurations that are available. The "Device configurations" window is empty if device configuration files have not yet been created for the measuring device.

Creating and editing a device configuration



By clicking "Save", the operating tool saves the changes. Otherwise, the changes are lost when the window is closed.

1. Click the Plus button to create a new device configuration.
 - ↳ A new device configuration with a system-assigned name appears in the list.
2. Double-click the device configuration name to change the name.
 - ↳ The new device configuration is automatically sorted alphabetically in the list.
3. Click the Edit button to create a new measuring point organization or to edit an existing one.
 - ↳ The "Organize measuring points" window appears.
4. Edit the measuring points in the "Organize measuring points" window → 29.
5. Set the device language in the "Language" selection field.
6. Click "Save" to save the configuration settings or click the Plus button to create additional device configurations.
 - ↳ The window closes when you click "Save".
 - ↳ The operating tool saves the new device configurations in the specified "Device configurations" working directory → 26.

Transferring the device configuration to the measuring device

1. Click the name of the device configuration to select the device configuration.
2. Click the Transfer button to save the device configuration in the measuring device.
 - ↳ The operating tool transfers the device configuration to the measuring device and overwrites the old device configuration.
 - ↳ The measuring device is disconnected from the operating tool and computer.
3. Reconnect the measuring device with the operating tool to make the changes visible in the operating tool. Reconnect the USB cable to the computer for this purpose.

9 Operation

9.1 Changing the operating language

Operating language settings →  25.

9.2 Performing the measurement

⚠ WARNING

Change of fluid

Risk of injury due to unforeseeable chemical reactions when changing the fluid.

- ▶ The temperature of the sensor may not exceed the flash point of the new liquid under measurement.
- ▶ Clean thoroughly to remove all traces of the previous liquid. When cleaning, make sure to use appropriate personal protection equipment.

NOTICE

Measurement result is not representative

Heterogeneous mixing, air bubbles and variations in temperature can lead to incorrect measurement results.

- ▶ Stir the liquid continuously to ensure a homogeneous liquid mix and an even balance of temperature.

9.2.1 Preparing a sample

If it is not possible to perform a measurement while the process is running, or in case of extreme temperature fluctuations or heterogeneous mixing, take the following recommendations into account when preparing the measurement:

- Extract sample from the process into a glass beaker or similar container.
- Stir the sample continuously to get an even balance of temperature between the liquid and the sensor and a homogeneous liquid mix.

9.2.2 Performing the measurement

1. Immerse the sensing area of the sensor completely in the liquid to be measured.
2. Switch on the measuring device with the On/Off button.
 - ↳ The local display of the measuring device starts booting.
 - ↳ A choice of measuring points appears.

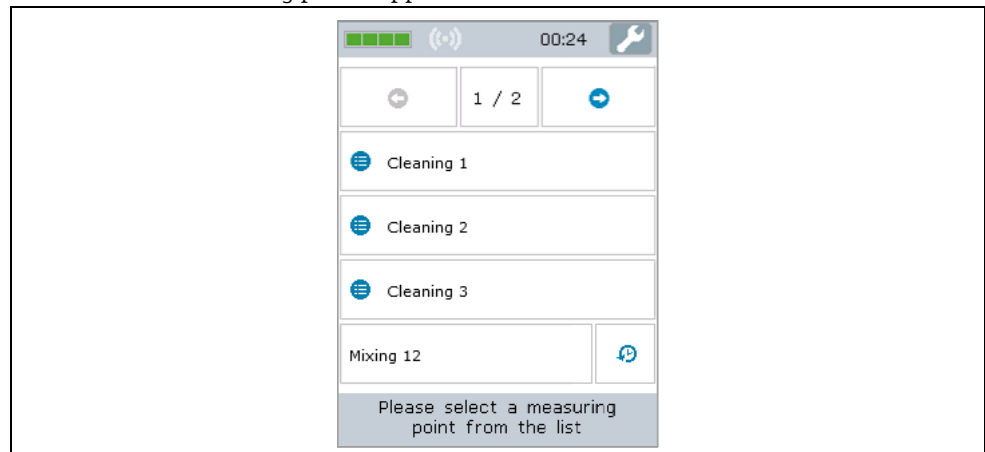

3. Click the measuring point on the touch screen to select it.

↳ Measuring conditions appear on the screen. The measuring device checks the measuring conditions.

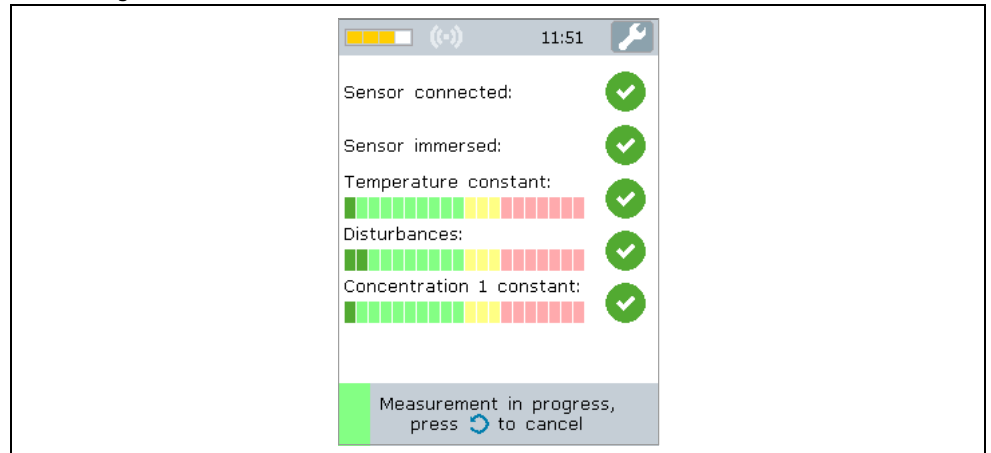

↳ If the measuring conditions are met, the measurement result appears on the new screen.

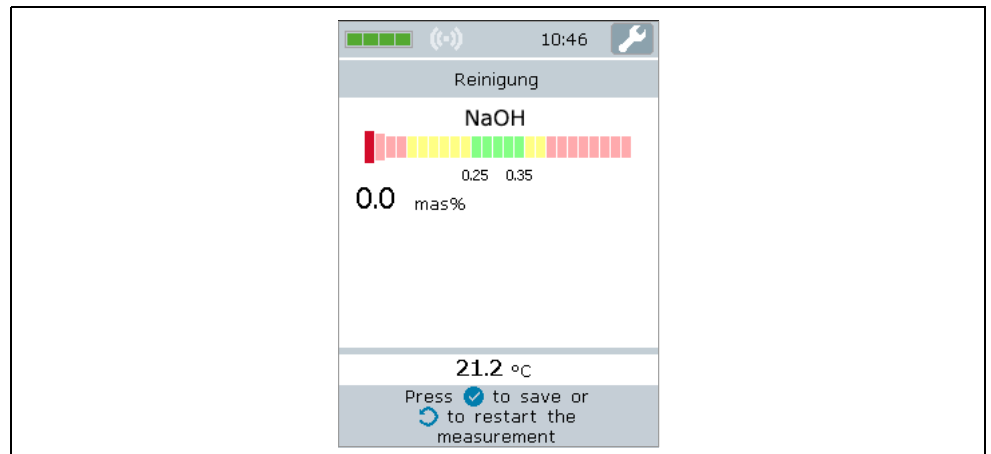

↳ If the measuring conditions are not met, an error message is displayed.

4. The following options are possible:
 - To repeat the measurement, press the Back/Repeat button.
 - ↳ The measuring device checks the measuring conditions again and performs the measurement once more.
 - To save the measurement, press the Confirm button.
 - ↳ The measuring device displays the saved measured value along with the last four measured values and saves it to the corresponding measuring point.
 - ↳ If a dosage recommendation is set for this measuring point, the measuring device displays a dosage recommendation (perform additional dosing or reject recommendation → 36).
5. Press the Back/Repeat button to return to the start screen.

9.3 Reading measured values

Once a measurement operation has been performed successfully, the measuring device displays the measured value on the screen. The result is displayed as a numerical value, and also as a graphic relative to the limit values specified for the measuring point → 16.

9.4 Additional dosage

A dosage recommendation can be configured for the measuring points. This recommendation appears as soon as the measured value is outside the valid, green range. The recommendation for additional dosing is based on the actual concentration level measured and the target concentration of the liquid indicated in the measuring point. The measuring device displays the recommendation after the measured value is saved. The recommendation is specified in liters or kilograms as an absolute amount or as a value per 100 liter tank volume. By organizing the customer's operating screen into measuring points, it is possible to create process-specific criteria for additional dosing for each process.

NOTICE

Incorrect process management

Irresponsible additional dosing can cause errors in the process. The user is responsible for managing the process correctly.

- ▶ Implement the dosage recommendation responsibly.

9.4.1 Performing an additional dosage

Requirements

- Measurement is performed and saved.
- Measured value is outside the valid range.

Performing an additional dosage

1. Add the additional dosage amount displayed to the concentration.
 -  Depending on whether the measured concentration is too high or too low, the measuring device recommends that you either add additional concentrate or additional base. If adding base to dilute the concentration, the user must first check whether it is even possible to add such an amount in the plant.
2. Press the Confirm button to accept the dosing recommendation.



↳ The keypad for entering the amount actually added appears on the screen.



3. Enter the amount actually added.
4. Confirm your entry. There are two ways to confirm your entry:
 - Confirmation by pressing the Confirm button on the touch screen.
 - Confirmation by pressing the Confirm button on the membrane keypad.
 ↳ Information on the measurement history and the maintenance measure performed appears on the screen.

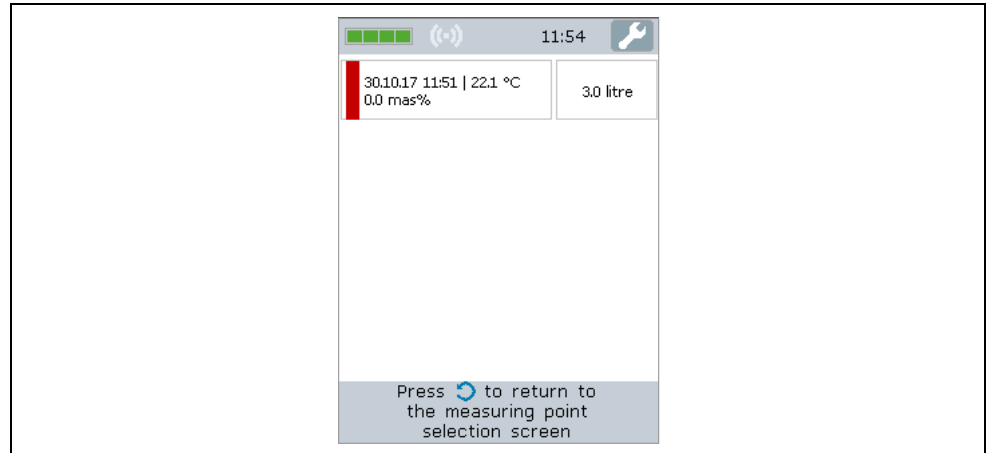

9.4.2 Rejecting a dosage recommendation

Requirements

- Measurement is performed and saved.
 - Measured value is outside the valid range.
- ▶ Press the Back/Repeat button to reject the dosing recommendation.
- ↳ The measuring device skips the dosage recommendation and the measurement history is displayed.

9.5 Accessing the measured data

Once the connection has been established to a computer via the USB mass storage medium or via the operating tool, measured values saved in the measuring device can be deleted from the measuring device or read out and saved as a .csv file. With the operating tool it is also possible to create a customized measured value report for the selected measuring point in PDF format.

-  The measuring device can save a maximum of 3000 measured values per measuring point with a maximum of 150 measuring points.

9.5.1 Reading out and/or deleting measured values via the USB mass storage medium

NOTICE

Spread of malicious software

The computer recognizes the transmitter as a mass storage medium. Because of this, malware that may be on the computer can potentially spread.

- ▶ Ensure suitable security measures are taken, such as the use of anti-virus software.



The measuring device cannot perform any measurements while it is connected to the computer.

1. Connect the measuring device to the computer (switched on) via the USB cable.
2. Switch on the measuring device with the On/Off button.
 - ↳ The computer recognizes the measuring device as a USB mass storage medium.
3. Double-click the USB mass storage medium on the computer to open it.
4. Double-click the "Data" folder to open it.
 - ↳ The folder contains a .csv file with the measured values for each measuring point.
5. If necessary, save the desired .csv file or .old file to the computer using the Copy function, or double-click the file to open it.
6. If necessary, delete the desired .csv file using the Delete function.

9.5.2 Reading out and/or deleting measured values via the operating tool

1. Select the menu "File" → "Save data from selected measuring point" or "Save data from all measuring points".
 - ↳ The "Select storage location" window is displayed.
2. Select the location for storing the .csv file containing the measured values.
 - ↳ The operating tool saves the .csv file in the selected directory.
3. Select the menu "Device configuration" → "Measured values" → "Delete (current)" or "Delete (all)".
 - ↳ The operating tool deletes the .csv files containing the measured values from the measuring device.

9.5.3 Generating a measured value report via the operating tool

Creating the report template

It is possible to add a customized report template within the report settings. When creating a report template, please note the following points:

Number of templates:

- ▶ Create a template for each of the following: initial page and subsequent pages .

Paper size:

- ▶ Create template files in A4 or Letter size.

File format:

- ▶ Save template files in PDF format.

Content areas and customizable areas:

- ▶ Only customize the white areas shown in the diagram. The content of the report is printed inside the shaded areas.

Content areas and customizable areas

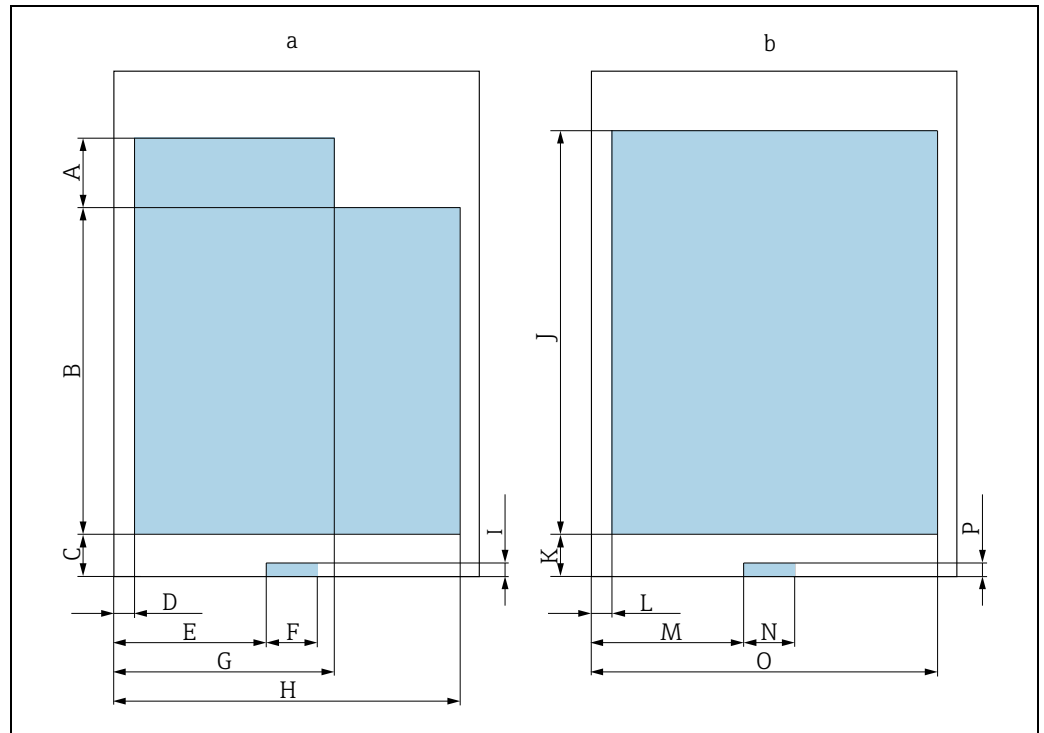

Fig. 14: Report template
 a Report template: initial page
 b Report template: subsequent pages

Report template: initial page (a)

Format (unit)	A	B	C	D	E	F	G	H	I
DIN A4 (mm)	41	192	25	13	90	30	130	204	8
US Letter (inch)	1.57	6.89	0.98	0.51	3.54	1.18	5.12	8.03	0.43

Report template: subsequent pages (b)

Format (unit)	J	K	L	M	N	O	P
DIN A4 (mm)	230	25	13	90	30	196	8
US Letter (inch)	8.46	0.98	0.51	3.54	1.18	7.87	0.43

Making initial report settings

1. Select the menu "Report" → "Settings".
 ↳ The "Report configuration" window appears.
2. Select report content. To do so, enable "Graph" and/or "Table".
3. Select paper size. If using a custom template file, use the paper size of the template file.
4. To receive a PDF preview of the document, enable "Open report".
5. To use a customized template, enable "Custom template" and select paths for the template files.
6. Click "Save" to save the settings made.
 ↳ The operating tool uses the settings when generating the report.

Creating the report

Requirements

- A measuring point with measured data is selected

1. Select the menu "Report" → "Create".
 - ↳ The "Settings report generation" window appears.
2. Specify the timeline for report generation. The following options are possible:
 - Select the start and end date for the report from the drop-down menu.
 - Select the check box "Use all available data for the report" to output all the available measured values as a PDF file.
3. Click "Next" to confirm the time settings.
 - ↳ The "Select location for report" window appears.
4. Select the location where the report is to be stored and click "Save" to save the report.



If the "Open PDF" check box was selected under "Report" → "Settings", the standard PDF viewer displays the report automatically.

9.6 Loading measured values in the operating tool

The operating tool allows users to retrieve measured data saved earlier with the **Open data** function.

Loading the data

1. Select the menu "File" → "Load data".
 - ↳ The "Select file" window appears.
2. Select the desired .csv file (measuring point) and click "Load data" to confirm.
 - ↳ The name of the file appears under "Measuring point".
 - ↳ The operating tool displays the measured data of the selected measuring point file.

9.7 Updating the firmware

Firmware updates can be installed with and without an operating tool.

The updates are available in the Download Area of the Endress+Hauser web site: www.endress.com → Downloads.

Specify the following details:

- Search area: "Software"
- Software type: "Device driver" and "Firmware Flash File"

9.7.1 Updating the firmware without an operating tool

NOTICE

Damage to the transmitter

Disconnecting the transmitter from the power supply or the computer during the update process can damage the transmitter.

- ▶ Do not disconnect the transmitter from the computer.
 - ▶ Make sure the battery is at least 50% charged before starting the update.
1. Connect the transmitter to the computer (switched on) via the USB cable.
 2. Start the transmitter by pressing the On/Off button.
 - ↳ The computer recognizes the transmitter as a USB mass storage medium.
 3. Double-click the USB mass storage medium on the computer to open it.
 4. Copy the .lcu file to the "Updates" folder.

5. Disconnect the transmitter from the computer.
 - ↳ The transmitter restarts automatically and runs the firmware update.
 - ↳ The version number changes if the firmware is updated successfully.

9.7.2 Updating the firmware with an operating tool

NOTICE

Damage to the transmitter

Disconnecting the transmitter from the power supply or the computer during the update program can damage the transmitter.

- ▶ Do not disconnect the transmitter from the computer.
 - ▶ Make sure the battery is at least 50% charged before starting the update.
1. Connect the transmitter to the computer (switched on) via the USB cable.
 2. Start the transmitter by pressing the On/Off button.
 3. Open the operating tool and select the .lcu file for updating the firmware via the menu "Device configuration" → "Update firmware".
 - ↳ The operating tool transfers the data to the transmitter.
 4. Disconnect the transmitter from the computer.
 - ↳ The transmitter restarts and runs the firmware update.
 - ↳ A message is displayed once the firmware update is completed.

10 Diagnostics and troubleshooting

10.1 General troubleshooting

For the local display

Error	Possible causes	Remedial action
Local display is dark.	Battery is flat.	Charge the battery → 24.

10.2 Error messages

The local display presents errors on the touch screen in text format.

Diagnostic message	Description	Measures
The concentration could not be clearly established. Possible causes include: – Liquid is not mixed well	The measuring device is unable to identify the concentrate or the measured concentration varies greatly during the measuring time.	Move the sensor continuously during the measurement process in order to obtain a homogeneous distribution of the liquid.
Too many process disturbances have been detected. Possible causes include: – Sensor is not uniformly heated – Bubbles or particles in the liquid – Bubbles on the surface of the sensor	Bubbles or particles interfere with the measurement.	Move the sensor continuously during the measurement process. If bubbles form on the surface of the sensor, briefly remove the sensor from the liquid and then immerse it in the liquid again.
The temperature calibration range has been exceeded/undershot.	The measuring system is adapted to the measurement tasks with a concentration app. This concentration app represents a calibration for the process liquid used and is only valid within the liquid's calibration range.	Find measuring conditions that are within the range.
The density calibration range has been exceeded/undershot.		
The calibration range for concentration 1 has been exceeded/undershot.		
No sensor is connected to the controller. Please check the connection.	Sensor not recognized.	Connect the sensor to the transmitter.
The temperature could not be clearly established. Possible causes: – The temperature of the sensor and liquid is not the same – The temperature of the liquid changes too quickly	The measuring device cannot determine the temperature.	Move the sensor continuously during the measurement process in order to obtain a homogeneous temperature distribution. Avoid taking measurements near heating elements in the bath.
No or insufficient bubble-free or particle-free liquid in the sensor. Please immerse the sensor in the liquid.	Insufficient liquid present, or the sensor does not detect any liquid or sufficient liquid due to the presence of too many bubbles or particles.	Immerse the sensor completely in the liquid or increase the volume of the liquid. If there are too many bubbles or particles, move the sensor. If bubbles form on the surface of the sensor, briefly remove the sensor from the liquid and then immerse it in the liquid again.

10.3 Checking the measuring device

The **Functional test** function on the local display is used to check the accuracy of the measuring device. The operating tool can read in the results and output a test report in PDF format (menu "Report" → "Functional test").

10.3.1 Performing the functional test

NOTICE

Incorrect test result

The use of tap water and the presence of air bubbles or variable environmental conditions (e.g. variations in temperature or flow) can corrupt the test result.

- ▶ Clean the sensor before performing the test.
- ▶ Only use distilled or fully deionized water with a conductivity of $<20 \mu\text{S}/\text{cm}$ to test the sensor.
- ▶ Boil the liquid for several minutes to prevent air bubbles occurring. Then allow the liquid to cool to room temperature.
- ▶ Ensure constant environmental conditions.

1. Open the Settings menu → "Functional test".
 - ↳ The functional test screen with the preparatory steps is displayed.
2. Follow the preparatory steps and then click Confirm to start the functional test.
 - ↳ The status of the measurement preparations appears on the local display.
 - ↳ The functional test starts automatically as soon as all the preparations for the measurement have been implemented, and provided that the temperature is stable and no process disturbances are present.
 - ↳ The test result appears after a few seconds. The following options are possible:
 - The message "Functional test successful" is displayed.
 - The message "Functional test failed. Recalibration is necessary." is displayed.
3. Confirm the test results by clicking "Confirm" in order to save the results. If a recalibration is necessary, please contact the Endress+Hauser Sales Center.

Permitted deviations:

 - Speed of sound: $\pm \leq 0.5 \text{ m/s}$
 - Density: $\pm \leq 0.003 \text{ g/cm}^3$

10.3.2 Creating a functional test report via the operating tool

Requirements

- "Tegwave Mobile Viewer" operating tool is started and connected to the measuring device.
- Functional test has been performed on the measuring device.

1. Open the menu "Report" → "Functional test".
 - ↳ The functional test appears under "Measuring point".
 - ↳ The results of the functional test are displayed in graph and table form
2. Via the menu "Report" → "Create" save the report on the computer in PDF format →  38.

10.4 Device information

Device information is available on the nameplate of the transmitter. Additional information can be read out via the **System information** function in the operating tool.

Navigation using the operating tool

Menu "Info" → "System information"

Overview of parameters with brief description

Parameter	Description	Display
Firmware Mobile	Displays the current version of the mobile transmitter.	Character string with the format: x.y.zz
SN Mobile	Displays the serial number.	Max. 12-digit numerical value
SN Sensor	Displays the serial number of the sensor. Note: The serial number can also be found on the nameplate of the sensor.	Max. 12-digit numerical value
Version Viewer	Displays the installed software version of the "Teqwave Mobile Viewer" operating tool.	Character string with the following format: x.y.zz
OS	Displays the operating system used.	-

10.5 Firmware history

Date	Firmware version	Order code for "Firmware version"	Changes	Documentation type	Documentation
05.2019	2.2.zz	Option 78	Original firmware	Operating Instructions	BA01824D/06/EN/02.19



It is possible to flash the firmware to the current version or the previous version → 40.

11 Maintenance

11.1 Maintenance tasks

No special maintenance work is required.

11.1.1 Cleaning

NOTICE

Damage to the sensor

Unsuitable cleaning agents or tools can damage the sensor.

- ▶ Use an oil-free cleaning agent that does not form a film to clean the sensor. Gently clean the surface using a soft brush.
- ▶ Do not damage the sensor.
- ▶ Never use cleaning agents that can corrode the material.

The inspection and cleaning intervals depend on the application.

When cleaning the exterior of the measuring device, always use cleaning agents that do not corrode the housing surface, sensor material and seals.

11.2 Endress+Hauser services

Endress+Hauser offers a wide variety of services for maintenance such as recalibration, maintenance service or device tests.



The Endress+Hauser Sales Center can provide detailed information on these services.

12 Repair

12.1 General information

Repair and modification concept

The Endress+Hauser repair and modification concept provides for the following:

- Spare parts are grouped into logical kits with the associated Installation Instructions.
- Repairs are carried out by Endress+Hauser Service or appropriately trained customers.
- A certified device can only be converted to another certified device version by Endress+Hauser Service or at the factory.

Notes for repair and modification

When repairing and modifying a measuring device, observe the following:

- Use original Endress+Hauser spare parts only.
- Carry out the repair according to the Installation Instructions (EA).
- Observe the applicable standards, national regulations, hazardous area documentation (XA) and certificates.
- Document every repair and each modification and enter them into the W@M life cycle management database.

12.2 Spare parts

W@M Device Viewer (www.endress.com/deviceviewer):

The Device Viewer contains a list of all the spare parts for the measuring device along with the order code. In addition, spare parts can also be ordered here. If available, users can also download the relevant Installation Instructions.



The serial number required for ordering the spare part is located on the nameplate.

12.3 Endress+Hauser services



Information about service and spare parts is available from the Endress+Hauser Sales Center.

12.4 Return

The measuring device must be returned if it is in need of repair or a factory calibration, or if the wrong measuring device has been delivered or ordered. As an ISO-certified company and also due to legal regulations, Endress+Hauser is obliged to follow certain procedures when handling any returned products that have been in contact with medium.

To ensure swift, safe and professional device returns, please refer to the information on the Endress+Hauser website at www.services.endress.com/return-material.

12.5 Disposal

12.5.1 Disposing of the measuring device

▲ WARNING

Danger to personnel and environment from fluids that are hazardous to health.

- ▶ Ensure that the measuring device and all cavities are free of fluid residues that are hazardous to health or the environment, e.g. substances that have permeated into crevices or diffused through plastic.

Observe the following during disposal:

- ▶ Observe valid federal/national regulations.
- ▶ Ensure proper separation and reuse of the device components.

13 Accessories

Various accessories are available for the measuring device, and can be ordered with the device or at a later stage from Endress+Hauser. The Endress+Hauser Sales Center can provide detailed information on the relevant order code. The product page on the Endress+Hauser website www.endress.com also contains additional information on the order code.

13.1 Device-specific accessories

Accessories	Description
Connecting cable between sensor and transmitter	Order code for "Cable, sensor connection" (order number: XPD0047)
Concentration app	Data record for integrating new fluids into the measuring device. The concentration apps are available on the CD-ROM. A list of the available concentration apps is provided in the Applicator. If you require a concentration app that is not already listed in the Applicator, Endress+Hauser requires a sample of the fluid to create the concentration app. Concentration apps must first be imported into the operating tool before they can be added from the tool to the measuring device as a measuring point. Endress+Hauser provides the concentration app in .lmf format. Every transmitter can use a maximum of 150 concentration apps. (Order number: DK9500)

13.2 Service-specific accessories

Accessories	Description
Applicator	Software for selecting and sizing Endress+Hauser measuring devices: <ul style="list-style-type: none"> ■ Calculation of all the data needed to identify the optimum measuring device. ■ Graphic representation of the calculation results Administration, documentation and access to all project-related data and parameters throughout the entire life cycle of a project and information about the concentration apps that are available. Applicator is available: <ul style="list-style-type: none"> ■ Via the Internet: https://portal.endress.com/webapp/applicator ■ On CD-ROM for installation on local computer
W@M	Life cycle management for plants. W@M provides support with a wide range of software applications over the entire process: from planning and procurement to the installation, commissioning and operation of the measuring devices. All the relevant device information, such as the device status, spare parts and device-specific documentation, is available for every device over the entire life cycle. The application already contains the data of the Endress+Hauser devices. Endress+Hauser also takes care of maintaining and updating the data records. W@M is available: <ul style="list-style-type: none"> ■ Via the Internet: www.endress.com/lifecyclemanagement ■ On CD-ROM for installation on local computer

14 Technical data

14.1 Application

The measuring device is designed exclusively for the measurement of the concentration of liquids.

To ensure that the device remains in proper operating condition for its service life, only use the measuring device for fluids to which the process-wetted materials are sufficiently resistant (→  51).

14.2 Function and system design

Measuring principle Concentration measurement using acoustic surface waves.

Measuring system For information on the structure of the device, see "Product description" →  8.

14.3 Input

Measured variables **Direct measured variable**

- Temperature

Derived measured variable

- Concentration

Internal measured variable



The internal measured variables are used to calculate the concentration. The measuring device does not show the measured variables on the local display.

- Speed of sound
- Density

Measuring ranges

Temperature	As per concentration app data sheet, maximum 0 to +100 °C (32 to +212 °F)
Concentration	As per concentration app data sheet, maximum 0 to 100 %
Speed of sound (internal measured variable)	600 to 2000 m/s
Density (internal measured variable)	0.7 to 1.5 g/cm ³

14.4 Power supply

Supply voltage The measuring device is powered by a built-in battery. The battery is charged via a USB port. Requirements for the charger →  13.

Battery

Battery type	Lithium ion battery
Capacity	2300 mAh
Charging time	approx. 2.5 h
Battery life	approx. 8 h, at least 40 measured value recordings

USB port

Supply voltage	DC 5 V, 1 A, BCv1.2 standard
----------------	------------------------------

Power consumption

Transmitter	Max. 2 W
-------------	----------

Power supply failure

The configuration and recorded data are retained in the device memory.

Electrical connection

→  13

Cable specification

→  13

14.5 Performance characteristics

Max. measured error

Temperature	±0.5 K
Speed of sound (internal measured variable)	±2 m/s
Density (internal measured variable)	±0.01 g/cm ³

Accuracy

Accuracy of concentration measurement

The accuracy depends on the concentration app. The data sheet for the concentration app contains detailed accuracy information under the "Approximation error" section.

Measuring frequencies

Concentration	Single measurement, value displayed averaged over 10 seconds
Temperature	Single measurement, value displayed averaged over 10 seconds

Response time

The response time for displaying the temperature depends on the transfer of heat from the fluid to the steel.

Influence of variations in the fluid temperature

If the temperature of the medium changes rapidly (>1.5 °C/min), the measuring device displays an error message.

Influence of vibrations

If the device is affected by mechanical or acoustic vibrations in the range of 0.8 to 2.0 MHz, the measuring device displays an error message.

Influence of air bubbles

Air bubbles and particles are disturbance factors when measuring with acoustic surface waves. The diagnostic functions integrated in the measuring device largely prevent an incorrect measurement result due to air bubbles or particles.

14.6 Environment

Ambient temperature range	Sensor	0 to +100 °C (+32 to +212 °F)
	Transmitter	0 to +40 °C (+32 to +104 °F)

Storage temperature	Sensor	-20 to +120 °C (-4 to +248 °F)
	Transmitter	-20 to +60 °C (-4 to +140 °F)

Degree of protection	Sensor	IP 68 (with cable plugged in)
	Transmitter	IP 65

Electromagnetic compatibility (EMC)

- As per IEC/EN 61326-1
- Complies with emission limit for industry as per EN 55011 (Class A)

For details, refer to the Declaration of Conformity.

14.7 Process

Medium temperature range 0 to +100 °C (+32 to +212 °F)

Flow velocity Max. 5 m/s (16.4 ft/s)

14.8 Mechanical construction

Design, dimensions For the dimensions and installation lengths of the device, see the "Technical Information" document, "Mechanical construction" section.

Weight	Transmitter	0.42 kg (0.93 lbs)
	Sensor	0.3 kg (0.7 lbs)
	Connecting cable	0.1 kg (0.2 lbs)

Materials

Transmitter

Housing	ABS plastic (acrylonitrile-butadiene-styrene copolymers)
Shockproof sealing	TPE plastic (thermoplastic elastomer)
Window material	Glass plate
Membrane keypad	<ul style="list-style-type: none"> ▪ Front membrane: Autotex V150 ▪ Bottom adhesive layer: DuploCOLL 101
USB connection	<ul style="list-style-type: none"> ▪ Socket: brass, nickel-plated ▪ Contact housing: polyetheretherketone (PEEK) ▪ Contacts: brass, chrome-plated
Push-pull connection	<ul style="list-style-type: none"> ▪ Socket: brass, nickel-plated ▪ Contact housing: polyetheretherketone (PEEK) ▪ Contacts: brass, chrome-plated

Sensor

Sensing element	Stainless steel, 1.4571 (V4A)
-----------------	-------------------------------

Connecting cable

Cable, external material	Polyurethane as per DIN EN 60811-2-1 (oil-resistant, halogen-free)
Connector	<ul style="list-style-type: none"> ▪ Socket: brass, nickel-plated ▪ Contact housing: polyetheretherketone (PEEK) ▪ Contacts: brass, chrome-plated

14.9 Operability

Local operation	<ul style="list-style-type: none"> ▪ Operation via touch screen and membrane keypad.
Operating tool	<ul style="list-style-type: none"> ▪ Operation via "Teqwave Mobile Viewer" Windows Desktop operating tool.
Reliable operation	<ul style="list-style-type: none"> ▪ If the power supply fails, data saved in the device and device configurations are retained.
Languages	<p>Can be operated in the following languages:</p> <ul style="list-style-type: none"> ▪ Via local operation (transmitter) English, German, French, Spanish, Italian ▪ Via operating tool English, German, French, Spanish, Italian

14.10 Certificates and approvals

CE mark	<p>The measuring system meets the legal requirements of the EU directives. Endress+Hauser confirms that the device has been successfully tested with the enclosed Declaration of Conformity and by applying the CE mark.</p>
C-tick symbol	<p>The measuring system meets the EMC requirements of the "Australian Communications and Media Authority (ACMA)".</p>
Other standards and guidelines	<ul style="list-style-type: none"> ▪ EN 60529 Degrees of protection provided by enclosures (IP code) ▪ EN 61010-1 Safety requirements for electrical equipment for measurement, control and laboratory use - general requirements ▪ IEC/EN 61326-1 Electromagnetic compatibility (EMC requirements) ▪ RoHS and EN 50581 Restriction of hazardous substances in electric and electronic devices.

Index

A

About this document.....	4
Accessories.....	48
Accuracy.....	50
Additional dosage.....	36
Additional dosage recommendation	
Rejecting.....	37
Air bubbles.....	50
Ambient temperature range.....	51
Application.....	6, 49
Applicator.....	48
Approvals.....	52

C

CE mark.....	52
Certificates.....	52
Charging the battery.....	24
Check	
Connection.....	14
Received goods.....	10
Checklist	
Post-connection check.....	14
Cleaning.....	45
Commissioning.....	24
Advanced settings.....	26
Configuring the measuring device.....	25
Setting the date and time.....	26
Setting the operating language.....	25
Concentration app.....	31
Concentration apps.....	8
Configuration manager.....	31
Configuring the offset.....	27
Connecting cable.....	13
Connecting the connecting cable.....	13
Connecting the USB cables.....	14
Connection.....	13
Connecting cable.....	13
USB cable.....	14
Connection conditions.....	13
Creating a measuring point.....	27
C-tick symbol.....	52

D

Declaration of conformity.....	7
Degree of protection.....	51
Designated use.....	6
Device information.....	44
Device repair.....	46
Diagnostics.....	42
Checking the measuring device.....	43
Error messages.....	42
Functional test.....	43
Functional test report.....	43
Dimensions.....	51
Disposal.....	47

Document

Purpose.....	4
Symbols used.....	4
Dosing recommendation.....	27
Configuring.....	27
Performing.....	36

E

Editing a measuring point.....	28
Electrical connection	
Charger.....	13
Connecting cable.....	13
Measuring device.....	13
Electromagnetic compatibility.....	51
Endress+Hauser services	
Maintenance.....	45
Repair.....	46
Error messages.....	42
Error screen.....	17
Extended order code.....	11

F

Firmware	
Updating the firmware.....	40
With an operating tool.....	41
Without an operating tool.....	40
Firmware history.....	44
Flow velocity.....	51
Fluids.....	6
Functional test.....	43
Functional test report.....	43

I

Importing concentration apps.....	26
Importing measuring points.....	26
Incoming acceptance.....	10
Input.....	49
IT security.....	7

L

Languages, operation options.....	52
Life cycle management.....	48
Local display	
Information area.....	17
Measurement display area.....	16
Measuring point selection.....	15
Operating keys.....	17
Local operation.....	52

M

Materials.....	51
Max. measured error.....	50
Measured value report.....	38
Measured values	
Access.....	37
Deleting.....	38
Loading in the Graph View.....	40

Reading	35	Performing the measurement	34
Reading out via operating tool	38	Post-connection check	14
Reading out via USB mass storage medium	38	Post-installation check	24
Measured variables	49	Power consumption	50
Measurement display area	16	Power supply failure	50
Measurement result	16	Process variables	
Measuring conditions	16	Derived	49
Measuring device		Measured	49
Access via the local display	15	Product description	8
Access via the operating tool	18	Product safety	7
Checking	43		
Cleaning	45	R	
Components	8	Recalibration	45
Configuring	25	Registered trademarks	5
Connecting	13	Reliability	52
Disposal	47	Repair	46
Identification	10	Notes	46
Modification	46	Repairing a device	46
Power supply	49	Replacement	
Repair	46	Device components	46
Switching on	24	Report	
Measuring frequency	50	Creating	38
Measuring point group	15, 29	Requirements for personnel	6
Measuring point information	31	Response time	50
Measuring point selection	15	Return	46
Measuring points	8, 16		
Adding	30–32	S	
Creating	27	Safety	6
Edit	28	Safety instructions	4
Measuring principle	49	Serial number	11
Measuring range	49	Services	45–46
Measuring system	49	Setting the date	26
Medium temperature range	51	Setting the operating language	25
Modification	46	Settings	
		Configuration manager	31
N		Measuring points	29, 31
Nameplate	11	Working directories	26
		Spare parts	46
O		Standards, guidelines	52
Occupational safety	6	Storage	12
Operating options	15	Storage conditions	12
Operating tool	52	Storage temperature	12
Establishing a connection	19	Storage temperature range	51
Graph view	22	Supply voltage	49
Menu bar	20	Symbols	
Quick navigation	21	For device	11
Software installation	18	System design	
System requirements	18	Measuring system	49
Table view	22		
User interface	19	T	
Operation	34	Technical data	49
Measuring	34	Temperature range	
Reading measured values	35	Medium temperature	51
Operational safety	7	Storage temperature	12
Order code	11	Transportation	12
Organize measuring points	29	Troubleshooting	42
		Error messages	42
P		General information	42
Packaging disposal	12		
Performance characteristics	50		

U

Using the measuring device

Incorrect use	6
Other risks	6

V

Variations in the fluid temperature.....	50
Vibrations.....	50

W

W@M	48
W@M Device Viewer	10, 46
Weight	51
Working directory	26

www.addresses.endress.com
