

# Technical Information

## Teqwave H

Ultrasonic concentration meter



Inline device with best-in-class hygienic design – plug and play for food and beverage processes

### Application

- The acoustic waveguide measures precisely and reliably, even the smallest changes are detected
- Continuous quality monitoring of beverages and in cleaning processes

### Device properties

- Nominal diameter: DN 25 (1")
- Accurate and independent of flow profile
- Industry-compliant, easy installation via DIN rail and pipe mounting kit
- 3.5" TFT color touch screen or LED indication
- 4-20 mA, Modbus TCP

### Your benefits

- High accuracy and repeatability – concentration calculation with latest algorithms
- Fulfilment of hygienic requirements – easily cleanable full-bore sensor
- Full transparency – constant monitoring of product quality without sampling
- Highest process safety – reliable metering due to robust, maintenance-free sensor
- Customized usage – innovative application concept, expendable for changing measuring tasks







## Table of contents

<b>About this document</b> . . . . .	<b>3</b>	Nominal pressure . . . . .	21
Symbols . . . . .	3	Flow velocity . . . . .	21
<b>Function and system design</b> . . . . .	<b>4</b>	<b>Mechanical construction</b> . . . . .	<b>22</b>
Measuring principle . . . . .	4	Dimensions in SI units . . . . .	22
Measuring system . . . . .	5	Dimensions in US units . . . . .	26
IT security . . . . .	7	Weight . . . . .	30
<b>Input</b> . . . . .	<b>7</b>	Materials . . . . .	30
Measured variables . . . . .	7	Process connections . . . . .	31
Measuring ranges . . . . .	7	Surface roughness . . . . .	31
Input signal . . . . .	11	<b>Operability</b> . . . . .	<b>31</b>
<b>Output</b> . . . . .	<b>11</b>	Local operation . . . . .	31
Output signal . . . . .	11	Supported operating tools . . . . .	31
Signal on alarm . . . . .	12	Reliable operation . . . . .	31
Galvanic isolation . . . . .	13	Languages . . . . .	31
Protocol-specific data . . . . .	13	<b>Certificates and approvals</b> . . . . .	<b>32</b>
<b>Power supply</b> . . . . .	<b>14</b>	CE mark . . . . .	32
Terminal assignment . . . . .	14	UKCA marking . . . . .	32
Supply voltage . . . . .	14	Sanitary compatibility . . . . .	32
Power consumption . . . . .	14	Additional certification . . . . .	32
Current consumption . . . . .	14	Other standards and guidelines . . . . .	32
Power supply failure . . . . .	14	<b>Ordering information</b> . . . . .	<b>33</b>
Electrical connection . . . . .	15	<b>Application packages</b> . . . . .	<b>33</b>
Potential equalization . . . . .	18	<b>Accessories</b> . . . . .	<b>33</b>
Terminals . . . . .	18	Device-specific accessories . . . . .	33
Cable specification . . . . .	18	Service-specific accessories . . . . .	34
<b>Performance characteristics</b> . . . . .	<b>19</b>	<b>Documentation</b> . . . . .	<b>34</b>
Maximum measured error . . . . .	19	Standard documentation . . . . .	35
Repeatability . . . . .	19	<b>Registered trademarks</b> . . . . .	<b>35</b>
Accuracy . . . . .	19		
Response time . . . . .	19		
Influence of variations in the medium temperature . . . . .	19		
Influence of vibrations . . . . .	19		
Influence of ambient temperature . . . . .	19		
Influence of gas bubbles . . . . .	20		
<b>Mounting</b> . . . . .	<b>20</b>		
Mounting location . . . . .	20		
Inlet and outlet runs . . . . .	20		
Mounting the transmitter housing . . . . .	20		
Special mounting instructions . . . . .	20		
<b>Environment</b> . . . . .	<b>21</b>		
Ambient temperature range . . . . .	21		
Storage temperature . . . . .	21		
Degree of protection . . . . .	21		
Interior cleaning . . . . .	21		
Electromagnetic compatibility (EMC) . . . . .	21		
<b>Process</b> . . . . .	<b>21</b>		
Medium temperature range . . . . .	21		
Temperature increase . . . . .	21		









## About this document

### Symbols

#### Electrical symbols



Symbol	Meaning
	Direct current
	Alternating current
	Direct current and alternating current
	<b>Ground connection</b> A grounded terminal which, as far as the operator is concerned, is grounded via a grounding system.
	<b>Protective earth (PE)</b> Ground terminals that must be connected to ground prior to establishing any other connections.  The ground terminals are located on the interior and exterior of the device: <ul style="list-style-type: none"> <li>■ Inner ground terminal: protective ground is connected to the power supply network.</li> <li>■ Outer ground terminal: the device is connected to the grounding system of the facility.</li> </ul>
	<b>Signal ground connection</b> A terminal that can be used as a ground contact for the digital input.
	<b>Switch output connection</b> A terminal that can be used as a switch output.

#### Symbols for certain types of information

Symbol	Meaning
	<b>Permitted</b> Procedures, processes or actions that are permitted.
	<b>Preferred</b> Procedures, processes or actions that are preferred.
	<b>Forbidden</b> Procedures, processes or actions that are forbidden.
	<b>Tip</b> Indicates additional information.
	Reference to documentation
	Reference to page
	Reference to graphic
	Visual inspection

#### Symbols in graphics

Symbol	Meaning
1, 2, 3, ...	Item numbers
<b>1</b> , <b>2</b> , <b>3</b> , ...	Series of steps
A, B, C, ...	Views
A-A, B-B, C-C, ...	Sections
	Hazardous area

Symbol	Meaning
	Safe area (non-hazardous area)
	Flow direction

## Function and system design

### Measuring principle

The measuring device is based on a patented ultrasonic technology that enables the precise and rapid measurement of concentrations of liquids.

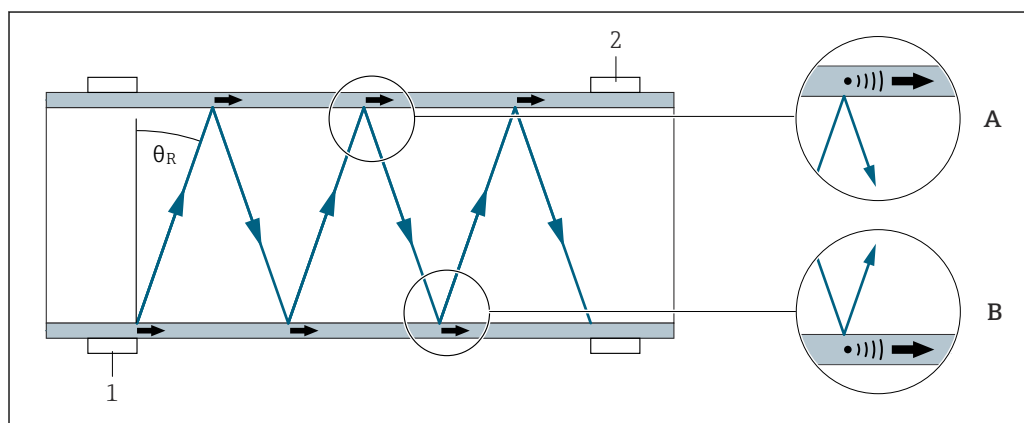

A0035710

A piezoelectric signal transducer (1) continuously stimulates high-frequency sound waves, which then propagate in the wall of the sensor (A and B). A second piezoelectric signal transducer (2) acts as the receiver. During the measurement process, the two signal transducers operate alternately as the transmitter and receiver.

If the sound waves come into contact with liquid, the waves disperse into the liquid. The angle of dispersion of the sound wave ( $\theta_R$ ) depends on the relationship between the speed of sound, the type of sound wave and the liquid.

The double transducer arrangement with one signal transducer acting as a transmitter and another as a receiver enables the extremely accurate analysis of the transmission times and amplitudes of the sound waves.

During this process, the measuring device also determines the acoustic impedance and the acoustic density of the liquid, in addition to the speed of sound. Another integrated sensor also measures the temperature.

### Concentration measurement

The measuring device calculates the concentrations of up to two components in liquid mixtures from the measured speed of sound, temperature and acoustic density.

### Temperature measurement

A temperature sensor measures the temperature of the liquid. Due to the position of the sensor and the good thermal conduction, the sensor also reliably detects fast changes in temperature. If the Kalman filter is enabled, the measuring device also uses information from the transit time of the acoustic wave. Two temperature measurements therefore take place simultaneously. This function is recommended for processes with frequent and rapid temperature changes. The measuring device displays the temperature as a separate measured variable. This measured variable is also used for concentration measurement.

### Sound velocity measurement

The measuring device determines the speed of sound in a non-contact manner using the propagation of the acoustic waves in the wave guide.

**Density measurement**

The measuring device calculates the acoustic density of the liquid directly from the speed of sound and the acoustic impedance.

**Measuring system**

The measuring device consists of a transmitter and a sensor. The sensor sends the measured signals to the transmitter for analysis. The transmitter transmits the measured values to the "Teqwave Viewer" operating tool via an Ethernet interface and the operating tool visualizes the measured values. In addition, an automation system can read out the measured values via Modbus TCP.

To measure the concentration, the measuring device uses concentration apps, which are individually tailored to the measurement task. The concentration apps can be ordered individually or grouped into applications.

**Transmitter**

Several transmitter versions are available.

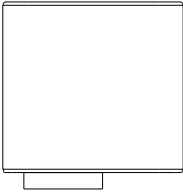
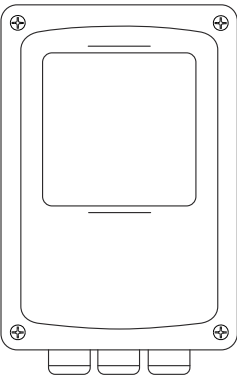

<p><b>Transmitter with aluminum housing</b></p>  <p>A0043170</p>	<p>Order code for "Transmitter housing", option A, "Aluminum, brushed"</p> <p>Material: Anodized aluminum</p> <p>Display/operation:</p> <ul style="list-style-type: none"> <li>▪ LED status indication or</li> <li>▪ Touch screen</li> </ul> <p>Degree of protection: IP40</p> <p>Mounting: DIN rail DIN EN 60715 TH 35</p>
<p><b>Transmitter with stainless steel housing</b></p>  <p>A0043171</p>	<p>Order code for "Transmitter housing", option B, "Stainless"</p> <p>For use in hygienic applications.</p> <p>Material: Stainless steel 1.4301 (304)</p> <p>Display/operation: Touch screen (can be operated once the housing cover is removed)</p> <p>Degree of protection: IP67</p> <p>Mounting: Wall or pipe mounting</p>

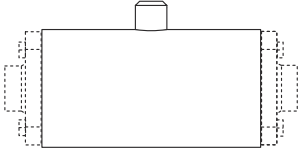
**Sensor**

<p><b>"Teqwave H" sensor</b></p>  <p>A0043235</p>	<p>Nominal diameters:</p> <ul style="list-style-type: none"> <li>▪ DN 25 (DIN)</li> <li>▪ 1" (ANSI)</li> </ul> <p>Materials:</p> <ul style="list-style-type: none"> <li>▪ Sensor: stainless steel, 1.4404 (316L)</li> <li>▪ Process connections: stainless steel, 1.4404 (316L)</li> <li>▪ Seals: EPDM, FKM or silicone</li> </ul> <p>Process connections:</p> <ul style="list-style-type: none"> <li>▪ Welding socket (EN 10357 (DIN 11850), ASME BPE, ODT/SMS, ISO 2037)</li> <li>▪ Clamp (ISO 2852, DIN 32676, L14 AM7 – Tri-Clamp)</li> <li>▪ Coupling (DIN 11851, DIN 11864-1, SMS 1145)</li> <li>▪ Flange DIN 11864-2</li> </ul> <p>Degree of protection:</p> <ul style="list-style-type: none"> <li>▪ IP67</li> <li>▪ With the order code for "Sensor options", option <b>CM</b>: additionally IP69</li> </ul>
--	---

### Analysis parameter

There are several options for ordering analysis parameters.

Order options for the order code for "Analysis parameters"	Description
Option O "Not used"	Select this option if several analysis parameters from an area of application (application package) are required. The order code for "Application; analysis parameter" lists the application packages available. Measuring ranges of the application packages →  7.
Option C "Temp., speed of sound, dispersion, acoustic density"	Select this option if only the actual measured values are required. These measured values allow users to determine the correlations of concentrations and measured values themselves.
Option D "Concentration as per medium-specific app number"	Select this option if an application-specific analysis parameter is required. The Applicator lists the available analysis parameters with the corresponding concentration app numbers on →  34.

### Concentration apps

Endress+Hauser provides a separate concentration app for every medium. A concentration app contains the necessary specific characteristics of speed of sound and acoustic density in a defined temperature range, which are required to calculate the concentration and other analysis parameters (e.g. the degree of inversion of sugar) of a liquid.

 The available concentration apps and analysis parameters, as well as the associated measuring ranges, are listed in the Applicator.

With the "Teqwave Viewer" operating tool, it is also possible to customize a concentration app to specific customer requirements and save the changes as a recipe. Furthermore, the accuracy of the analysis parameters of certain concentration apps can be improved by integrating additional external or entered measured values (e.g. pressure).

Apart from the preconfigured concentration apps which are available by default, Endress+Hauser also creates individual concentration apps specifically for your application.

 Your Endress+Hauser sales organization can provide detailed information on this service.

Every transmitter can manage a maximum of 25 concentration apps or recipes.

The data sheet provided with a concentration app contains information about the medium, the analysis parameters, the permitted measuring ranges, the compensation values and the accuracy of the concentration measurement.

### Applications

Packages with multiple concentration apps can be ordered for the measuring device either during the initial purchase or subsequently. The concentration apps are grouped by application area and enable the measurement of analysis parameters (e.g. concentration of sugar and alcohol) of different media in an industry, e.g. in distilleries or the production of soft drinks.

Order options available for the order code for "Application; Analysis parameters":

- Option A "Distillery; sugar, invert sugar, alcohol"
- Option B "Soft drink production; sugar, invert sugar"
- Option C "Cleaning; concentration of disinfectant, cleaner, water purity"

Concentration apps and measuring ranges contained in the packages →  7.

### Operating tool

Two versions of the "Teqwave Viewer" operating tool are available. Supported functions:

Included in the standard scope of supply: Teqwave Viewer V2.3 – basic package	Order code for "Application package", option EP: Teqwave Viewer V2.3 - Viewer with interface for data download
<ul style="list-style-type: none"> <li>▪ Live display and graphic visualization of measured variables</li> <li>▪ Save graph</li> <li>▪ Manage concentration apps and recipes on the transmitter</li> <li>▪ Device configurations</li> <li>▪ Switch between multiple transmitters</li> <li>▪ Self-test</li> </ul>	<ul style="list-style-type: none"> <li>▪ Live display and graphic visualization of measured variables</li> <li>▪ Save graph</li> <li>▪ Manage concentration apps and recipes on the transmitter</li> <li>▪ Device configurations</li> <li>▪ Switch between multiple transmitters</li> <li>▪ Self-test</li> <li>▪ Read saved measured values</li> <li>▪ Offline analysis with graphic visualization of the measured values</li> <li>▪ Measured value logging and export function</li> </ul>

### IT security

Our warranty is valid only if the device is installed and used as described in the Operating Instructions. The device is equipped with security mechanisms to protect it against any inadvertent changes to the settings.

IT security measures, which provide additional protection for the device and associated data transfer, must be implemented by the operators themselves in line with their security standards.

## Input

### Measured variables

#### Measured variables

- Speed of sound
- Temperature
- Dispersion (relative indicator for disturbance)
- Acoustic density

#### Analysis parameters available for order

- Concentration
- Concentration ratio (ratio between two concentrations)
- Calculated physical density

### Measuring ranges

Speed of sound	600 to 2 000 m/s
Temperature	0 to 120 °C (32 to 248 °F)
Acoustic density	0.7 to 1.5 g/cm <sup>3</sup>
Analysis parameter	As per the concentration app data sheet

Order code for "Application; analysis parameter", option A "Distillery; sugar, invert sugar, alcohol"

Name of concentration app <sup>1)</sup>	Analysis parameter	Measuring range	Temperature range	Compensation values
Pure alcohol; 36-99%vol; 2-35°C	Alcohol concentration	36 to 99 % vol	2 to 35 °C (36 to 96 °F)	<ul style="list-style-type: none"> <li>▪ Pressure</li> <li>▪ Mineral content</li> </ul>
Pure alcohol; 36-99%vol; 30-60°C	Alcohol concentration	36 to 99 % vol	30 to 60 °C (86 to 140 °F)	<ul style="list-style-type: none"> <li>▪ Pressure</li> <li>▪ Mineral content</li> </ul>

Name of concentration app <sup>1)</sup>	Analysis parameter	Measuring range	Temperature range	Compensation values
Liquor 35-99%vol; 2-60°C; manual sugar compensation	Alcohol concentration	35 to 99 % vol	2 to 60 °C (36 to 140 °F)	<ul style="list-style-type: none"> <li>■ Pressure</li> <li>■ Mineral content</li> <li>■ Sugar concentration</li> </ul>
Liquor 35-62%vol; 2-35°C; automatic invert sugar compensation	Alcohol concentration	35 to 62 % vol	2 to 35 °C (36 to 96 °F)	<ul style="list-style-type: none"> <li>■ Pressure</li> <li>■ Mineral content</li> </ul>
Liquor 35-62%vol; 30-60°C; automatic invert sugar compensation	Alcohol concentration	35 to 62 % vol	30 to 60 °C (86 to 140 °F)	<ul style="list-style-type: none"> <li>■ Pressure</li> <li>■ Mineral content</li> </ul>
Liquor 53-95%vol; 2-35°C; automatic invert sugar compensation	Alcohol concentration	53 to 95 % vol	2 to 35 °C (36 to 96 °F)	<ul style="list-style-type: none"> <li>■ Pressure</li> <li>■ Mineral content</li> </ul>
Liquor 53-95%vol; 30-60°C; automatic invert sugar compensation	Alcohol concentration	53 to 95 % vol	30 to 60 °C (86 to 140 °F)	<ul style="list-style-type: none"> <li>■ Pressure</li> <li>■ Mineral content</li> </ul>
Liquor 35-62%vol; 2-35°C; automatic sugar compensation	Alcohol concentration	35 to 62 % vol	2 to 35 °C (36 to 96 °F)	<ul style="list-style-type: none"> <li>■ Pressure</li> <li>■ Mineral content</li> </ul>
Liquor 35-62%vol; 30-60°C; automatic sugar compensation	Alcohol concentration	35 to 62 % vol	30 to 60 °C (86 to 140 °F)	<ul style="list-style-type: none"> <li>■ Pressure</li> <li>■ Mineral content</li> </ul>
Liquor 53-95%vol; 2-35°C; automatic sugar compensation	Alcohol concentration	53 to 95 % vol	2 to 35 °C (36 to 96 °F)	<ul style="list-style-type: none"> <li>■ Pressure</li> <li>■ Mineral content</li> </ul>
Liquor 53-95%vol; 30-60°C; automatic sugar compensation	Alcohol concentration	53 to 95 % vol	30 to 60 °C (86 to 140 °F)	<ul style="list-style-type: none"> <li>■ Pressure</li> <li>■ Mineral content</li> </ul>
Liquor 10-25%vol; 5-30°C; alc.+invert sugar measurement	Alcohol concentration	10.2 to 25 % vol	5 to 30 °C (41 to 86 °F)	<ul style="list-style-type: none"> <li>■ Pressure</li> <li>■ Mineral content</li> <li>■ Acid</li> <li>■ Physical density</li> </ul>
	Invert sugar concentration	7 to 40 °Brix		
Liquor 30-55%vol; 0-50°C; alc.+invert sugar measurement	Alcohol concentration	30.4 to 55.8 % vol	0 to 50 °C (32 to 122 °F)	<ul style="list-style-type: none"> <li>■ Pressure</li> <li>■ Mineral content</li> <li>■ Acid</li> <li>■ Physical density</li> </ul>
	Invert sugar concentration	0 to 35 °Brix		
Liquor 10-25%vol; 5-30°C; alc.+sugar measurement	Alcohol concentration	10.2 to 25 % vol	5 to 30 °C (41 to 86 °F)	<ul style="list-style-type: none"> <li>■ Pressure</li> <li>■ Mineral content</li> <li>■ Acid</li> <li>■ Physical density</li> </ul>
	Sugar concentration	7 to 40 °Brix		
Liquor 30-55%vol; 0-50°C; alc.+sugar measurement	Alcohol concentration	30.4 to 55.8 % vol	0 to 50 °C (32 to 122 °F)	<ul style="list-style-type: none"> <li>■ Pressure</li> <li>■ Mineral content</li> <li>■ Acid</li> <li>■ Physical density</li> </ul>
	Sugar concentration	0 to 35 °Brix		

1) The name is on the data sheet and is shown on the local display and in the Viewer.

**Order code for "Application; analysis parameter", option B "Soft drink production; sugar, invert sugar"**

Name of concentration app	Analysis parameter	Measuring range	Temperature range	Compensation value
Fruit juice; sugar concentration; 0-25°Brix	Sugar concentration at 0% inversion <sup>1)</sup>	0 to 25 °Brix	2 to 40 °C (36 to 104 °F)	<ul style="list-style-type: none"> <li>■ Pressure</li> <li>■ Acid</li> <li>■ Degree of inversion</li> </ul>
	Invert sugar concentration at 100% inversion <sup>2)</sup>	0 to 26.3 °Brix		



Name of concentration app	Analysis parameter	Measuring range	Temperature range	Compensation value
	Brix at 20°C as per ICUMSA table <sup>3)</sup>	0 to 25 °Brix		
<b>Softdrink; sugar concentration; 0-15°Brix</b>	Sugar concentration with 0% inversion <sup>1)</sup>	0 to 15 °Brix	2 to 40 °C (36 to 104 °F)	<ul style="list-style-type: none"> <li>■ Pressure</li> <li>■ Acid</li> <li>■ Degree of inversion</li> <li>■ CO<sub>2</sub></li> </ul>
	Invert sugar concentration with 100% inversion <sup>2)</sup>	0 to 15.7 °Brix		
	Brix at 20°C as per ICUMSA table <sup>3)</sup>	0 to 15 °Brix		
<b>Light-Softdrink; sugar concentration; 0-1.5°Brix</b>	Sugar concentration	0 to 1.5 °Brix	2 to 40 °C (36 to 104 °F)	<ul style="list-style-type: none"> <li>■ Pressure</li> <li>■ Acid</li> <li>■ CO<sub>2</sub></li> </ul>
<b>Syrup-Juice concentrate; 20-65°Brix; 2-30°C</b>	Sugar concentration with 0% inversion <sup>1)</sup>	20 to 65 °Brix	2 to 30 °C (36 to 86 °F)	<ul style="list-style-type: none"> <li>■ Pressure</li> <li>■ Acid</li> <li>■ Degree of inversion</li> </ul>
	Invert sugar concentration with 100% inversion <sup>2)</sup>			
	Brix at 20°C as per ICUMSA table <sup>3)</sup>			
<b>Syrup-Juice concentrate; 20-65 °Brix; 2-30°C; external density</b>	Sugar concentration with 0% inversion <sup>1)</sup>	20 to 65 °Brix	2 to 30 °C (36 to 86 °F)	<ul style="list-style-type: none"> <li>■ Pressure</li> <li>■ Acid</li> <li>■ Physical density</li> </ul>
	Invert sugar concentration with 100% inversion <sup>2)</sup>			
	Brix at 20°C as per ICUMSA table <sup>3)</sup>			
	Degree of inversion			
<b>Syrup-Juice concentrate; 20-65 °Brix; 15-40°C</b>	Sugar concentration with 0% inversion <sup>1)</sup>	20 to 65 °Brix	15 to 40 °C (59 to 104 °F)	<ul style="list-style-type: none"> <li>■ Pressure</li> <li>■ Acid</li> <li>■ Degree of inversion</li> </ul>
	Sugar concentration with 100% inversion <sup>2)</sup>			
	Brix at 20°C as per ICUMSA table <sup>3)</sup>			
<b>Syrup-Juice concentrate; 20-65°Brix; 15-40°C; external density</b>	Sugar concentration with 0% inversion <sup>1)</sup>	20 to 65 °Brix	15 to 40 °C (59 to 104 °F)	<ul style="list-style-type: none"> <li>■ Pressure</li> <li>■ Acid</li> <li>■ Physical density</li> </ul>

Name of concentration app	Analysis parameter	Measuring range	Temperature range	Compensation value
	Sugar concentration with 100% inversion <sup>2)</sup>			
	Brix at 20°C as per ICUMSA table <sup>3)</sup>			
	Degree of inversion			

- 1) Recommended for beverages that primarily contain sucrose as the sweetener. The °Brix value is calculated back to a solution that is only sweetened with sucrose.
- 2) Recommended for beverages that primarily contain invert sugar or fructose as the sweetener. The °Brix value is calculated back to a solution that is completely inverted, comparable to a laboratory analysis.
- 3) Enables the comparison of measuring devices, e.g. in the event of parallel laboratory measurements with refractometers or density meters.

**Order code for "Application; analysis parameter", option C "Cleaning; disinfectant, concentration of cleaner, water purity"**

Name of concentration app	Analysis parameter	Measuring range	Temperature range
<b>Sodium hydroxide</b>	Concentration of NaOH in water	0 to 4.5 % mas	15 to 89 °C (59 to 192 °F)
<b>Potassium hydroxide</b>	Concentration of KOH in water	0 to 4.5 % mas	15 to 85 °C (59 to 185 °F)
<b>Phosphoric acid</b>	Concentration of H <sub>3</sub> PO <sub>4</sub> in water	0 to 4.5 % mas	20 to 78 °C (68 to 172 °F)
<b>Nitric acid</b>	Concentration of HNO <sub>3</sub> in water	0 to 3 % mas	20 to 80 °C (68 to 176 °F)
<b>Sulfuric acid</b>	Concentration of H <sub>2</sub> SO <sub>4</sub> in water	0 to 3 % mas	10 to 45 °C (50 to 113 °F)
<b>Hydrogen peroxide</b>	Concentration of H <sub>2</sub> O <sub>2</sub> in water	20 to 40 % mas	5 to 40 °C (41 to 104 °F)
<b>Mip SCA</b>	Concentration of Mip SCA in water	0 to 7.5 % mas	20 to 90 °C (68 to 194 °F)
<b>Mip CA</b>	Concentration of Mip CA in water	0 to 3 % mas	10 to 87 °C (50 to 188 °F)
<b>InteroxAGSpray35S</b>	Concentration of H <sub>2</sub> O <sub>2</sub> in water	30 to 36 % mas	5 to 35 °C (41 to 95 °F)
<b>Hydrosan stabil</b>	Concentration of Hydrosan Stabil in water	0 to 4.5 % mas	10 to 35 °C (50 to 95 °F)
<b>CIP Reiniger CL extra</b>	Concentration of CIP Cleaner CL Extra in water	0 to 4.5 % mas	10 to 40 °C (50 to 104 °F)
<b>CIP Reiniger Alkalisch NS</b>	Concentration of CIP Cleaner Alkaline NS in water	0 to 6 % mas	10 to 89 °C (50 to 192 °F)
<b>Wigogreen MMA</b>	Concentration of Wigogreen MMA in water	0 to 3 % mas	15 to 45 °C (59 to 113 °F)
<b>Waterdeviation</b>	Deviation from reference (demin. water) in m/s		2 to 95 °C (36 to 203 °F)

**Input signal****Digital input**

<b>Function</b>	Select analog channel 1 to 4; The digital inputs "0" and "1" can only be connected to the signal ground.
<b>Version</b>	Open and ground Do not connect external voltage to these terminals.

**External measured values**

To increase the accuracy, the automation system can write a variety of compensation values to the measuring device:

- Operating pressure (Endress+Hauser recommends the use of a pressure measuring device for absolute pressure, e.g. Cerabar M or Cerabar S)
- CO<sub>2</sub> concentration
- Degree of inversion
- Mineralization
- Physical density
- Acid content
- Sugar concentration

The data sheet of the concentration app and the Applicator contain detailed information about compensation options.

 If it is not possible to read measured values into the measuring device using external sensors, the values can be saved as constant measured values.

*Digital communication*

The measured values can be written by the automation system via:

## Output

**Output signal****Ethernet (Modbus protocol)**

<b>Physical interface</b>	RJ-45 (8P8C)
---------------------------	--------------

**Current output 4 to 20 mA/voltage output 0 to 10 V**

<b>Function</b>	Can be configured as a current output or voltage output, as required
<b>Version</b>	Galvanically isolated
<b>Open-circuit voltage</b>	DC 15.5 V
<b>Assignable measured variables</b>	<ul style="list-style-type: none"> <li>■ Off</li> <li>■ On</li> <li>■ Analysis parameter 1...n</li> <li>■ Temperature</li> <li>■ Speed of sound</li> <li>■ Dispersion</li> <li>■ Acoustic density (optional)</li> <li>■ Suspend measurement</li> </ul>
<b>Current output</b>	4 to 20 mA
<b>Maximum output value</b>	20 mA
<b>Load</b>	0 to 500 Ω
<b>Resolution</b>	1.5 μA
<b>Voltage output</b>	0 to 10 V
<b>Maximum output value</b>	10 V

<b>Load</b>	> 750 Ω
<b>Resolution</b>	1 mV

**Switch output**

<b>Function</b>	Switch output
<b>Version</b>	Relay output, galvanically isolated
<b>Maximum switching capacity</b>	AC 30 V/DC 50 V, 1 A
<b>Switching behavior</b>	<ul style="list-style-type: none"> <li>▪ NC contact</li> <li>▪ NO contact</li> </ul>
<b>Assignable functions</b>	<ul style="list-style-type: none"> <li>▪ Off</li> <li>▪ On</li> <li>▪ Limit value (can be configured as a range or trigger value, as required): <ul style="list-style-type: none"> <li>▪ Analysis parameter 1...n</li> <li>▪ Temperature</li> <li>▪ Speed of sound</li> <li>▪ Dispersion</li> <li>▪ Acoustic density</li> </ul> </li> </ul>

**Signal on alarm****Ethernet (Modbus protocol)**

<b>Status bit</b>	Diagnostics information via status bits
-------------------	---

**Current output 4 to 20 mA / voltage output 0 to 10 V**

<b>Failure mode</b>	The breakdown information to be displayed in the event of a breach of the measuring range (over-range/under-range) can be configured in the <b>Output settings</b> parameter: <ul style="list-style-type: none"> <li>▪ Failure value for measured variable if the "0 V/2 mA exceeding limits" option is selected: 2 mA or 0 V</li> <li>▪ Failure value for measured variable if the "Min/Max exceeding limits" option is selected: 4 to 20 mA or 0 to 10 V</li> </ul>
	The breakdown information to be displayed in the event of a breach of the calibration range (over-range/under-range) can be configured in the <b>View filter</b> parameter: <ul style="list-style-type: none"> <li>▪ Failure value for measured variable if the "Calibration range limits" option is selected: 2 mA or 0 V</li> <li>▪ If the measuring device exceeds or drops below the calibration range for the temperature, a failure value is also displayed for the concentration or analysis parameter if this is active.</li> </ul>
	The breakdown information to be displayed if the process is not stationary (stationarity) can be configured in the <b>View filter</b> parameter: Failure value for the concentration or analysis parameter if the <b>Enable stationarity</b> option is selected: 2 mA or 0 V
	The breakdown information to be displayed if the rate of change exceeds the limit value can be configured in the <b>Change in [measured variable]</b> parameter. If the function is enabled: Failure value for concentration or analysis parameter: 2 mA or 0 V
	In the event of process disturbances (dispersion) above the limit value: Failure value for concentration or analysis parameter: 2 mA or 0 V
	If there is not enough liquid or the sensor is faulty: Failure value for all measured variables: 2 mA or 0 V

**Relay output**

<b>Failure mode</b>	If the temperature measurement range is exceeded or undershot: For the concentration or analysis parameter: the current status is held.
	If the temperature calibration range is exceeded or undershot: For the concentration or analysis parameter: the current status is held.
	The breakdown information to be displayed if the process is not stationary (stationarity) can be configured in the <b>View filter</b> parameter. If the "Enable stationarity" option is selected: For the concentration or analysis parameter: the current status is held.
	The breakdown information to be displayed if the rate of change exceeds the limit value can be configured in the <b>Change in [measured variable]</b> parameter. If the function is enabled: For the concentration or analysis parameter: the current status is held.
	In the event of process disturbances (dispersion) above the limit value: For the concentration or analysis parameter: the current status is held.
	If there is not enough liquid: Measured value for all measured variables with the exception of temperature: 0 switch status as per the setting for the switching threshold or switch point ("Operating Instructions" document, "Configuring the relay output" section).
	If the sensor is faulty: Measured value for all measured variables: 0 switch status as per the setting for the switching threshold or switch point ("Operating Instructions" document, "Configuring the relay output" section).

**Local display (transmitter with touch screen)**

<b>Color encoding</b>	Color field indicates measurement and device error ("Operating Instructions" document, "Diagnostics information on local display and in operating tool" section)
<b>Plain text display</b>	Display alternates between information on the cause and the measured value display

**Local display (transmitter with LED)**

<b>Light emitting diodes (LED)</b>	Status indicated by four light emitting diodes ("Operating Instructions" document, "Diagnostics information for transmitter with LED status indication" section)  The light emitting diodes indicate the following information: <ul style="list-style-type: none"> <li>▪ Supply voltage active</li> <li>▪ Error-free measuring system</li> <li>▪ Device alarm/error has occurred</li> <li>▪ Problem with connection to sensor</li> </ul>
------------------------------------	--

**"Teqwave Viewer" operating tool**

<b>Color encoding</b>	Color field indicates measurement and device error ("Operating Instructions" document, "Diagnostics information on local display and in operating tool" section)
<b>Plain text display</b>	Information on the cause

**Galvanic isolation**

The current and relay outputs are galvanically isolated from the rest of the system.



**Protocol-specific data**

<b>Protocol</b>	Modbus Applications Protocol Specification V1.1
<b>Response times</b>	Typically 10 to 50 ms
<b>Device type</b>	Slave
<b>Function codes</b>	<ul style="list-style-type: none"> <li>▪ 0x04: Read Input Registers</li> <li>▪ 0x10: Write Multiple Registers</li> </ul>

<b>Modbus data transmission</b>	Big endian
<b>Data access</b>	Each measured variable can be accessed via Modbus TCP.

## Power supply

### Terminal assignment

Terminal	Assignment	Description
V+	<b>V<sub>in</sub></b> DC 24 V	Supply voltage
V-		
+	<b>out</b> 0 to 10 V; 4 to 20 mA	Analog output
-		
0	<b>output selection</b>	Digital input
1		Digital input ground
		
	<b>alarm</b> Max. AC 30 V/DC 50 V, 1 A	Switch output
		

### Supply voltage

<b>Transmitter</b>	DC 24 V ±20%
--------------------	--------------

 The power unit must be tested to ensure it meets safety requirements (PELV).

### Power consumption

<b>Transmitter</b>	4 W
--------------------	-----

### Current consumption

<b>Transmitter</b> Maximum switch-on current	6 A
---	-----

### Power supply failure

The configuration and recorded data are retained in the device memory.

Electrical connection

Connections and connecting cable: transmitter in aluminum housing

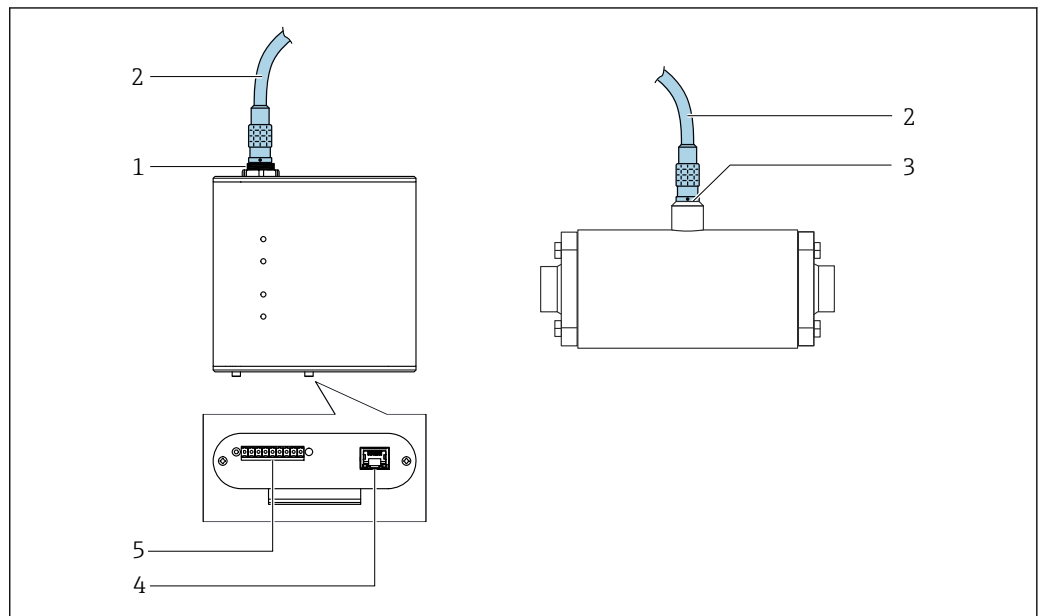

A0043238

**1** Connections and connecting cable: transmitter in aluminum housing

- 1 Push-pull connection, transmitter
- 2 Connecting cable
- 3 Push-pull or M12 connection, sensor
- 4 Ethernet interface for digital signal transmission ("Teqwave Viewer" operating tool and Modbus protocol)
- 5 Terminal strip with supply voltage, analog output, switch output and digital input, terminal assignment  
→ 14

**i** The connecting cable is available in the following lengths: 1 m (3 ft), 2 m (6 ft), 5 m (15 ft) and 10 m (30 ft).

## Connections and connecting cable: transmitter in stainless steel housing

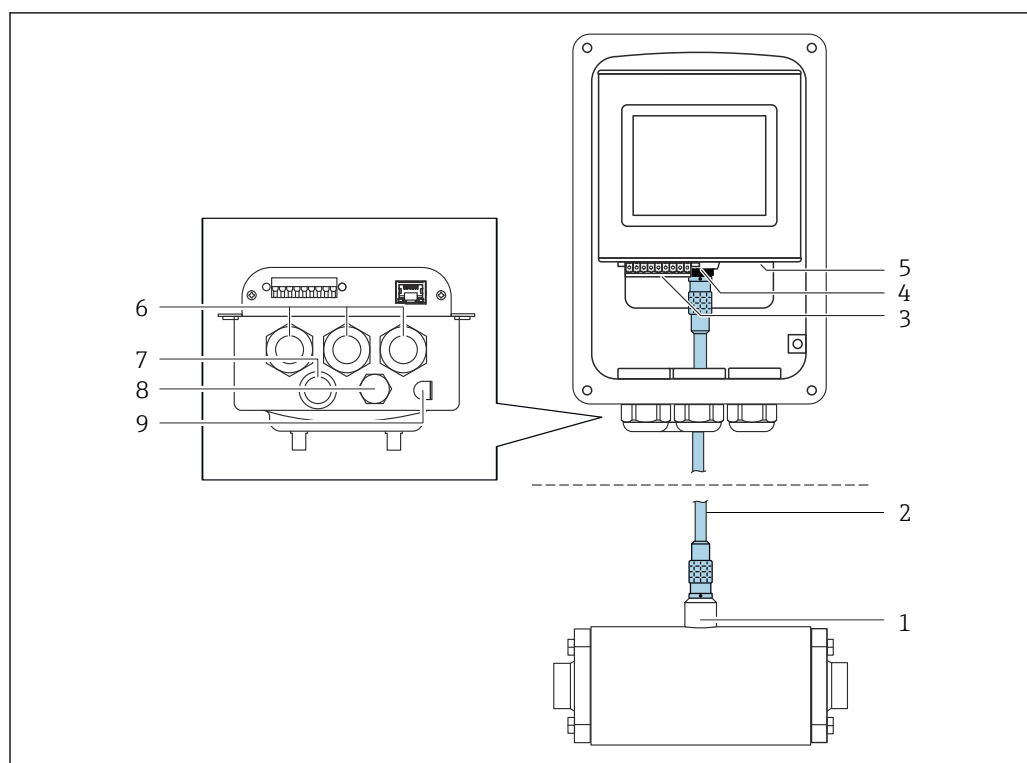

A0043193

### 2 Connections and connecting cable: transmitter in stainless steel housing

- 1 Push-pull or M12 connection, sensor
- 2 Connecting cable
- 3 Terminal strip with supply voltage, analog output, switch output and digital input, terminal assignment  
→ 14
- 4 Push-pull connection, transmitter
- 5 Ethernet interface for digital signal transmission ("Teqwave Viewer" operating tool and Modbus protocol)
- 6 M20 cable entries for terminal strip connection, push-pull connection for the transmitter and RJ45 Ethernet interface
- 7 M16 cable entry for terminal strip connection
- 8 Connection for pressure compensation element
- 9 Ground terminal

**i** The connecting cable is available in the following lengths: 1 m (3 ft), 2 m (6 ft), 5 m (15 ft) and 10 m (30 ft).

### Connection examples

Current output 4 to 20 mA

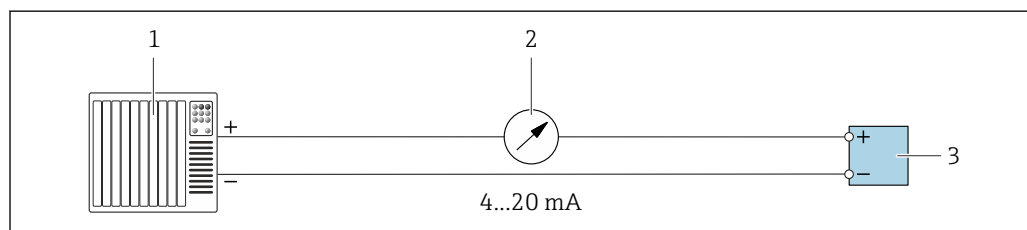

A0028758

### 3 Connection example for current output, active, 4 to 20 mA

- 1 Automation system with current input (e.g. PLC)
- 2 Analog display unit: maximum load 500 Ω
- 3 Transmitter



Voltage output 0 to 10 V

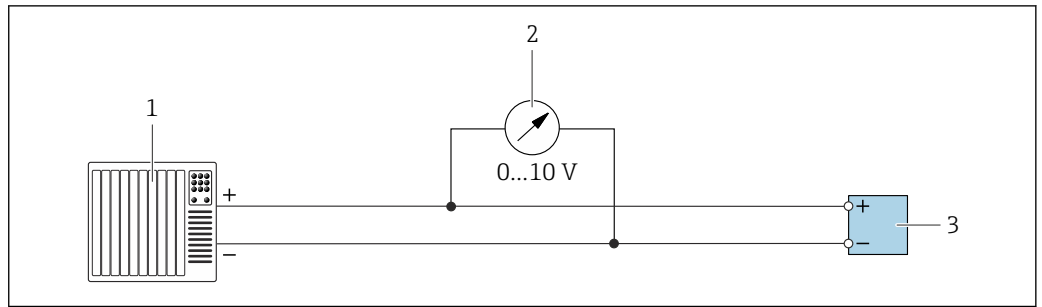

A0035460

4 Connection example for voltage output, active, 0 to 10 V

- 1 Automation system with current or voltage input (e.g. PLC)
- 2 Analog display unit for voltage: the load must be at least 750 Ω
- 3 Transmitter

Switch output

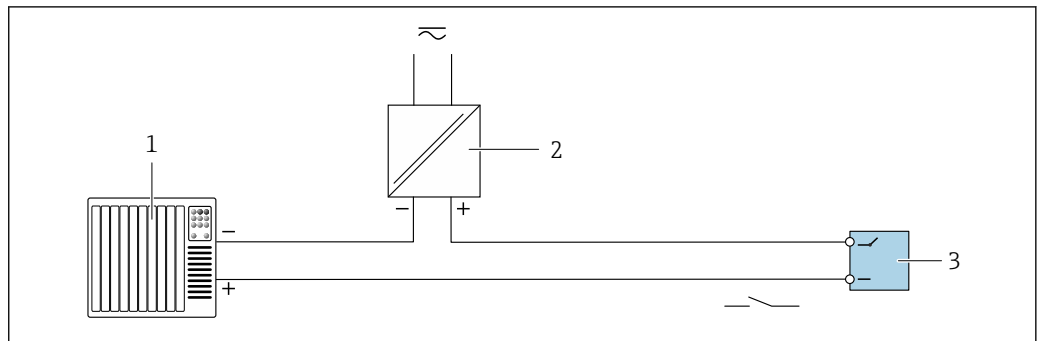

A0035461

5 Connection example for switch output, passive

- 1 Automation system with switch input (e.g. PLC)
- 2 Supply voltage: max. AC 30 V/DC 50 V
- 3 Transmitter

Digital input (elective inputs)

The digital input can output up to four measured variables on the analog output.

Configuration options:

Active analog output	Digital input "0"	Digital input "1"
Channel 1	Open	Open
Channel 2	Ground	Open
Channel 3	Open	Ground
Channel 4	Ground	Ground

**NOTICE**

**Interference at the digital input**

If the measuring device is connected incorrectly, this can impact the functional integrity of the device.

- If the digital input is used, only connect digital inputs "0" and "1" to signal ground.

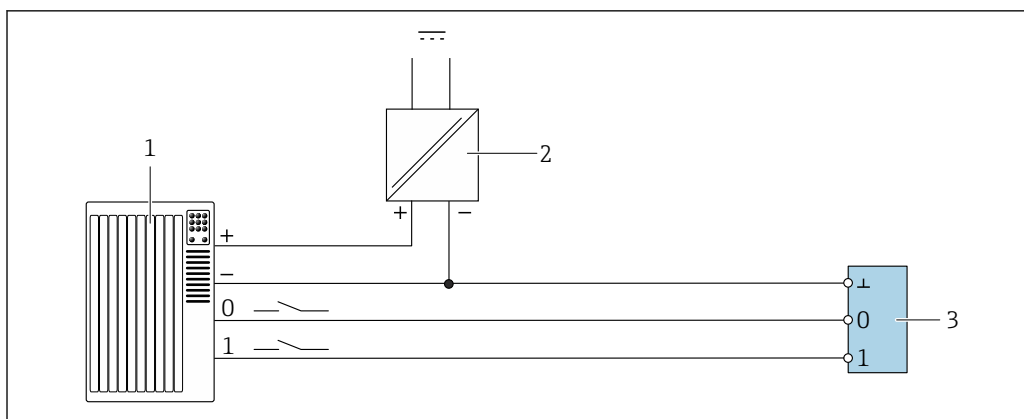

A0035462

6 Connection example for the digital input

- 1 Automation system with switch input (e.g. PLC)
- 2 Power supply
- 3 Transmitter

**i** If the transmitter is connected as illustrated in the example, the outputs are no longer galvanically isolated.

**Potential equalization**

The measuring device must be included in the potential equalization. The transmitter and sensor are connected to the same potential via the connecting cable. This potential must be current-free. Terminal assignment → 14.

**i** In addition to the sensor housing, the terminal V- must also be grounded.

**Terminals**

<b>Terminal type</b>	Screw terminals
<b>Conductor cross-section</b>	0.129 to 1.31 mm <sup>2</sup> (16 to 26 AWG)

**Cable specification**

**Permitted temperature range**

- The installation guidelines that apply in the country of installation must be observed.
- The cables must be suitable for the minimum and maximum temperatures to be expected.

**Sensor/transmitter connecting cable**

Only use the cable supplied.

**Modbus Ethernet cable**

<b>Cable type</b>	100 Base-TX
<b>Cable category</b>	Min. CAT5
<b>Plug type</b>	RJ-45 (8P8C)
<b>Shielding</b>	S/FTP, F/FTP, SF/FTP, S/UTP, F/UTP or SF/UTP
<b>Cable length</b>	Max. 30 m (98 ft)

**Power supply and signal cables**

<b>Cable type</b>	Strand or solid wire
<b>Conductor cross-section</b>	0.129 to 1.31 mm <sup>2</sup> (16 to 26 AWG)
<b>Temperature range</b>	<ul style="list-style-type: none"> <li>▪ -40 to 70 °C (-40 to +158 °F) when mounted in a fixed position</li> <li>▪ -10 to 50 °C (+14 to +122 °F) when cable can move freely</li> </ul>
<b>Cable length</b>	Max. 30 m (98 ft)

<b>Power supply cable</b>	Standard installation cable is sufficient.
<b>Analog output</b>	Standard installation cable is sufficient.
<b>Digital input</b>	Standard installation cable is sufficient.
<b>Switch output (alarm)</b>	Standard installation cable is sufficient.

**Requirements for the supply unit**

<b>Supply voltage</b>	DC 24 V ±20%
<b>Version</b>	Touch-safe circuit according to DIN EN 61010-1, as terminal V- is electrically connected to the transmitter housing.
<b>Power unit</b>	The power unit must be tested to ensure it meets safety requirements (PELV), as the measuring device is Class III equipment.

**Performance characteristics**

<b>Maximum measured error</b>	<b>Speed of sound</b>	±2 m/s (±6.56 ft/s)
	<b>Temperature</b>	±0.5 K
	<b>Acoustic density</b>	±0.01 g/cm <sup>3</sup>

<b>Repeatability</b>	<b>Speed of sound</b>	±0.3 m/s (0.98 ft/s)
	<b>Temperature</b>	±0.1 K
	<b>Acoustic density</b>	±0.0015 g/cm <sup>3</sup>

<b>Accuracy</b>	<b>Concentration measurement accuracy</b>
	The measuring device can achieve a concentration accuracy of up to 0.01 % absolute. The accuracy depends on the concentration app. The data sheet for this and the Applicator (→ 34) contain detailed accuracy information.
	<b>i Compensation of cross-interference</b> Depending on the concentration app, various compensation values can be entered or read into the measuring device to compensate for known cross-interference. → 11.

<b>Response time</b>	<b>i Influence of medium temperature</b> The response time of the temperature measurement depends on the transfer of heat from the liquid to the steel. Activation of the Kalman filter accelerates the response time. An erratic change in the temperature generates a temporary error message. A threshold for displaying the error can be set.
----------------------	--

<b>Influence of variations in the medium temperature</b>	If the medium temperature changes quickly (>1.5 °C/min (2.7 °F/min)), the measured error can be greater than specified in the "Maximum measured error" section.
--	---

<b>Influence of vibrations</b>	The measured error can be greater than specified in the "Maximum measured error" section as a result of mechanical, acoustic or electrical vibrations in the 0.8 to 2.0 MHz range. We recommend using a dedicated power unit and not the mains power supply.
--------------------------------	--

<b>Influence of ambient temperature</b>	<b>Current/voltage output</b>
	<b>Temperature coefficient</b>

**Influence of gas bubbles**

Gas bubbles and particles are disturbance factors when measuring with ultrasonic waves. The recommended installation positions and the "Dispersion" diagnostic information largely prevent incorrect measurement results caused by gas bubbles or particles.

**i** In the case of media with a high CO<sub>2</sub> content, there is the danger of CO<sub>2</sub> outgassing. To prevent outgassing, the process pressure must be set in such a way that the CO<sub>2</sub> saturation limit is not exceeded at the specific process temperature.

## Mounting

**Mounting location**

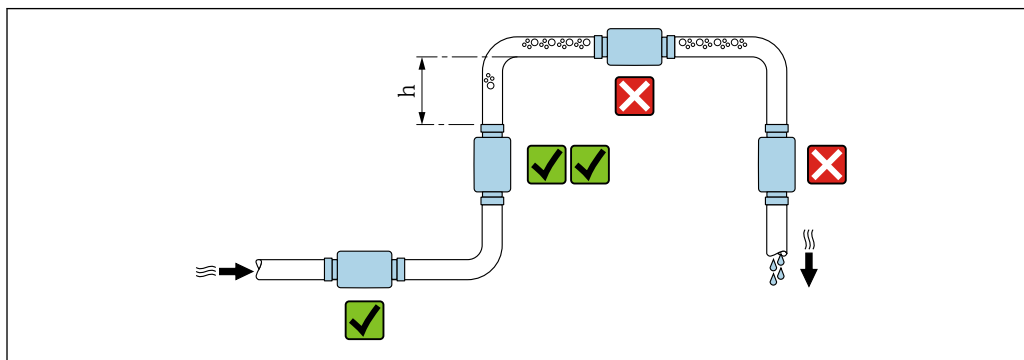

A0032998

**7** Mounting location

Preferably install the sensor in an ascending pipe, and ensure a sufficient distance to the next pipe elbow:  $h \geq 5 \times DN$ .

**Inlet and outlet runs**

Observe the following inlet and outlet runs to comply with accuracy specifications:

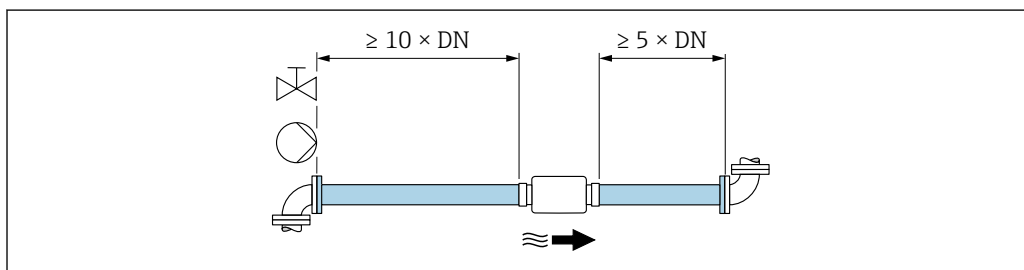

A0035458

**8** Inlet and outlet runs

**Mounting the transmitter housing**

**Transmitter with aluminum housing**

Mount on the DIN rail DIN EN 60715 TH 35 using the DIN rail holder.

**Transmitter with stainless steel housing**

The transmitter can be mounted in the following ways:

- Mounting with mounting plate
- Mounting with transmitter holder for post mounting (accessory)

**Special mounting instructions**

**Hygienic compatibility**

If installing in hygienic applications:

- Observe the instructions in the "Certificates and approvals/hygienic compatibility" section → 32.
- Ensure that liquid cannot accumulate on the outside of the measuring device.
- If the measuring device is installed horizontally, align the connection socket for the connecting so it is pointing upwards.
- Select the orientation in such a way that the measuring device is self-draining when installed. Installation with an angle of inclination  $>3^\circ$  is recommended for this purpose.

## Environment

<b>Ambient temperature range</b>	<b>Sensor</b>	0 to +60 °C (+32 to +140 °F)
	<b>Transmitter</b>	0 to +60 °C (+32 to +140 °F)
<b>Storage temperature</b>	0 to +60 °C (+32 to +140 °F)	
<b>Degree of protection</b>	<b>Sensor</b>	Standard: IP67, suitable for Pollution degree 4 With the order code for "Sensor options", option <b>CM</b> : additionally IP69
	<b>Transmitter</b>	With the order code for "Transmitter housing", option <b>A</b> , "Brushed aluminum": IP40 With the order code for "Transmitter housing", option <b>B</b> , "Stainless": IP67
<b>Interior cleaning</b>	CIP according to EHEDG Doc. 2	
	<p><b>NOTICE</b></p> <p><b>Large and particularly rapid temperature increases can damage the sensor.</b></p> <ul style="list-style-type: none"> <li>▶ Ensure that the immediate temperature increase of the medium does not exceed 55 °C/s (99 °F/s).</li> </ul>	
<b>Electromagnetic compatibility (EMC)</b>	<ul style="list-style-type: none"> <li>▪ As per IEC/EN 61326-1</li> <li>▪ Complies with emission limit for industry as per EN 55011 (Class A)</li> </ul> <p>For details, refer to the Declaration of Conformity.</p> <p> This unit is not intended for use in residential environments and cannot guarantee adequate protection of the radio reception in such environments.</p>	

## Process

<b>Medium temperature range</b>	<b>Sensor</b>	0 to +120 °C (+32 to +248 °F)
<b>Temperature increase</b>	<b>Sensor</b>	Max. 55°C/s (99 °F/s)
	<p><b>NOTICE</b></p> <p><b>Large and particularly rapid temperature increases can damage the sensor.</b></p> <ul style="list-style-type: none"> <li>▶ Ensure that the immediate temperature increase of the medium does not exceed 55 °C/s (99 °F/s).</li> </ul>	
<b>Nominal pressure</b>	<b>Sensor</b>	Max. 16 bar (232 psi) at 20 °C (68 °F)
<b>Flow velocity</b>	Max. 10 m/s (32.8 ft/s)	

## Mechanical construction

Dimensions in SI units

Transmitter with aluminum housing

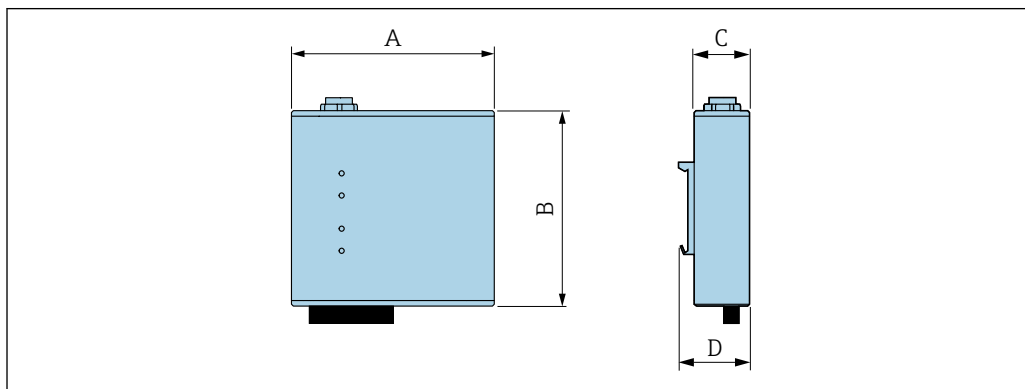

A0043203

Order code for "Transmitter housing", option A "Aluminum, brushed"

A [mm]	B [mm]	C [mm]	D [mm]
110	104	30	38

Transmitter with stainless steel housing

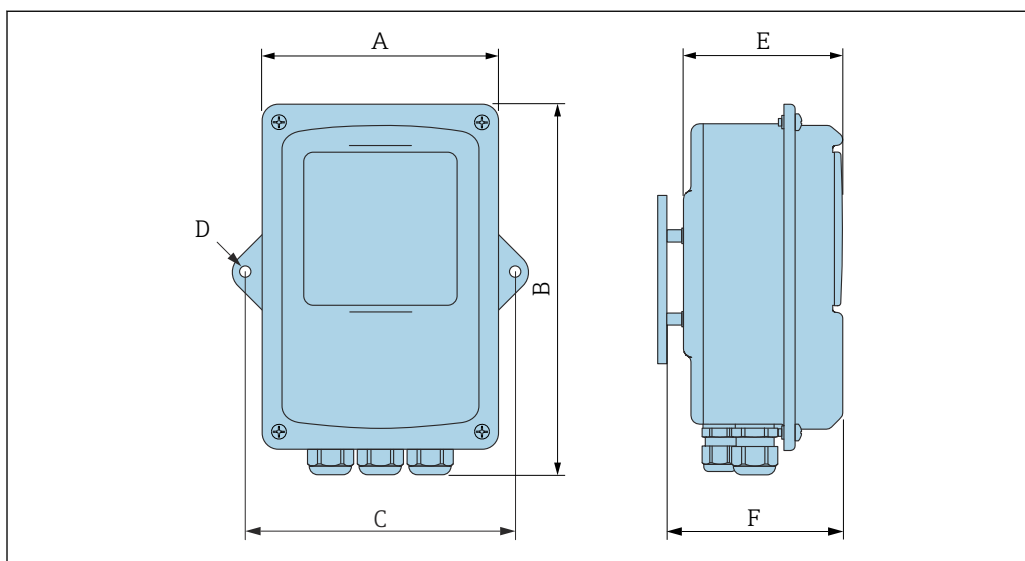

A0043204

Order code for "Transmitter housing", option B, "Stainless"

A [mm]	B [mm]	C [mm]	D [mm]	E [mm]	F [mm]
142	225	160	7	95	100

**Transmitter holder for mounting on posts**

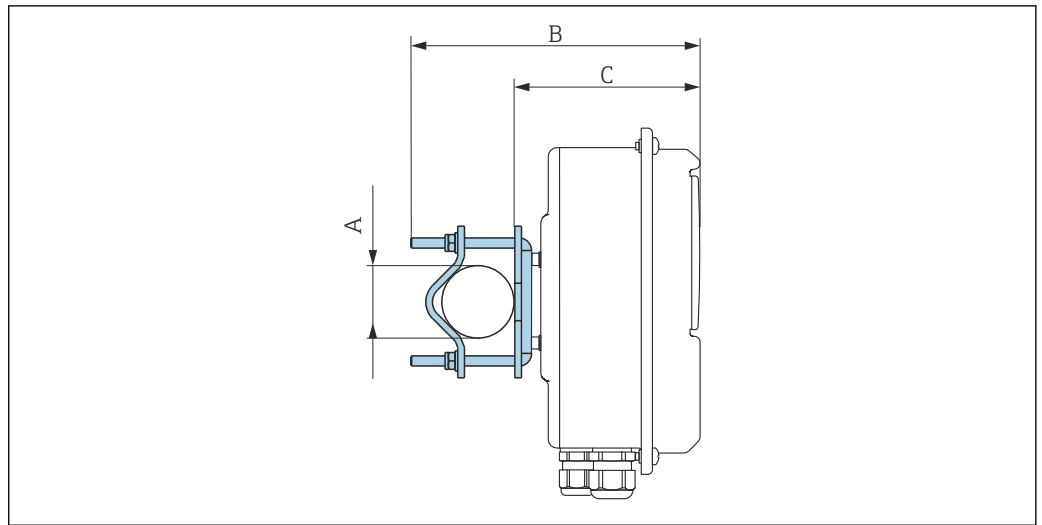

A0043202

Order code for "Accessory enclosed", option PC "Transmitter holder (pipe mounting)" or subsequently with the order number 50062121

A [mm]	B [mm]	C [mm]
φ max. 60	170	109

**Sensor**

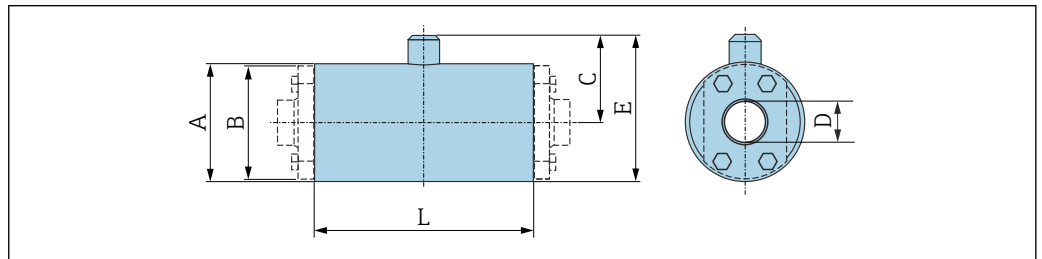

A0043225

DN	A [mm]	B [mm]	C [mm]	D [mm]	E [mm]	L [mm]
25 mm (DIN)	75	72	56.6	26	94	140
1" (ANSI)	75	72	56.6	22.6	94	140

**Clamp connections with aseptic gasket seal**

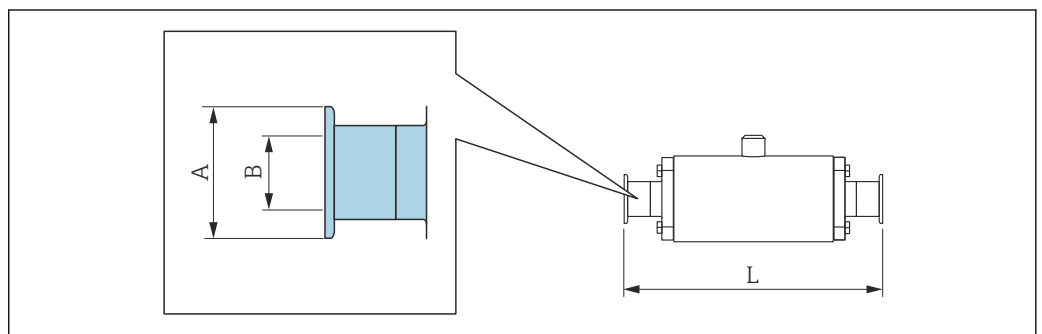

A0043226

**Clamp according to DIN 32676**  
**1.4404 (316L)**  
*Order code for "Process connection", option DB*

DN [mm]	Suitable for pipe EN 10357 (DIN 11850) [mm]	A [mm]	B [mm]	L [mm]
25	30 × 2 (DN 25)	50.5	26	229

Surface roughness:  $R_a \leq 0.78 \mu\text{m}$   
 Please note the internal diameters of the measuring tube and process connection (B) when cleaning with pigs.

**Tri-Clamp**  
**1.4404 (316L)**  
*Order code for "Process connection", option FA*

DN	Suitable for pipe as per ASME BPE [mm]	A [mm]	B [mm]	L [mm]
1"	25.4 × 1.65	50.4	22.1	197

Surface roughness:  $R_a \leq 0.78 \mu\text{m}$   
 Please note the internal diameters of the measuring tube and process connection (B) when cleaning with pigs.

**Clamp according to ISO 2852, Fig. 2**  
**1.4404 (316L)**  
*Order code for "Process connection", option IB*

DN	Suitable for pipe ISO 2037 [mm]	A [mm]	B [mm]	L [mm]
1"	25.4 × 1.65	50.5	22.6	228.6

Surface roughness:  $R_a \leq 0.78 \mu\text{m}$   
 Please note the internal diameters of the measuring tube and process connection (B) when cleaning with pigs.

**Welding socket with aseptic gasket seal**

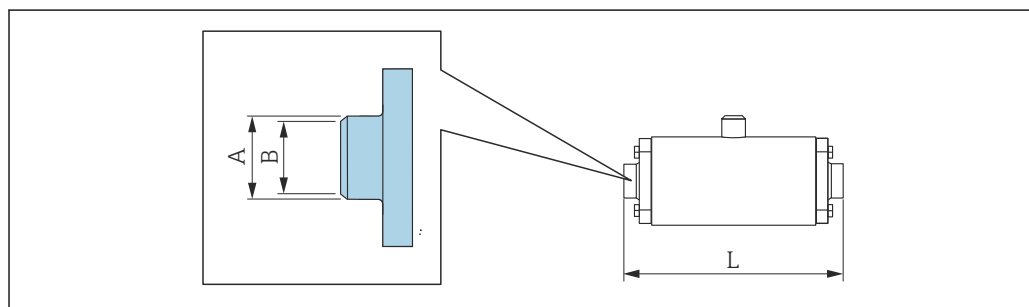

A0043230

**Welding socket according to EN 10357 (DIN 11850)**  
**1.4404 (316L)**  
*Order code for "Process connection", option DA*

DN [mm]	Suitable for pipe EN 10357 (DIN 11850) [mm]	A [mm]	B [mm]	L [mm]
25	29 × 1.5	29	26	186.6

Surface roughness:  $R_a \leq 0.78 \mu\text{m}$   
 Please note the internal diameters of the measuring tube and process connection (B) when cleaning with pigs.



**Welding socket according to ISO 2037**  
**1.4404 (316L)**  
*Order code for "Process connection", option IA*

DN	Suitable for pipe ISO 2037 [mm]	A [mm]	B [mm]	L [mm]
1"	25.4 × 1.60	25	22.6	172.2

Surface roughness:  $R_a \leq 0.78 \mu\text{m}$   
 Please note the internal diameters of the measuring tube and process connection (B) when cleaning with pigs.

**Welding socket according to ASME BPE**  
**1.4404 (316L)**  
*Order code for "Process connection", option AA*

DN	Suitable for pipe ASME BPE [mm]	A [mm]	B [mm]	L [mm]
1"	25.4 × 1.65	25.4	22.1	172.2

Surface roughness:  $R_a \leq 0.78 \mu\text{m}$   
 Please note the internal diameters of the measuring tube and process connection (B) when cleaning with pigs.

**Welding socket according to ODT/SMS**  
**1.4404 (316L)**  
*Order code for "Process connection", option HB*

DN	Suitable for pipe ODT/SMS [mm]	A [mm]	B [mm]	L [mm]
1"	25.4 × 1.65	25.4	22.6	172.2

Surface roughness:  $R_a \leq 0.78 \mu\text{m}$   
 Please note the internal diameters of the measuring tube and process connection (B) when cleaning with pigs.

**Flange connections with aseptic gasket seal**

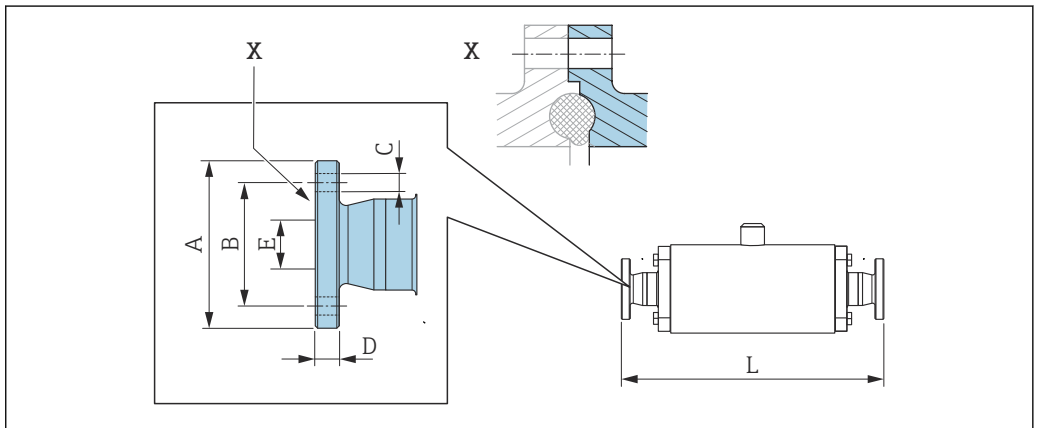

A0043229

**Flange DIN 11864-2, aseptic female, Form A**  
**1.4404 (316L)**  
*Order code for "Process connection", option DE*

DN [mm]	Suitable for pipe EN 10357 (DIN 11850) [mm]	A [mm]	B [mm]	C [mm]	D [mm]	E [mm]	L [mm]
25	29 × 1.5 (DN 25)	70	53	4 × Ø9	10	26	237

Surface roughness:  $R_a \leq 0.78 \mu\text{m}$   
 Please note the internal diameters of the measuring tube and process connection (E) when cleaning with pigs.

**Couplings with aseptic gasket seal**

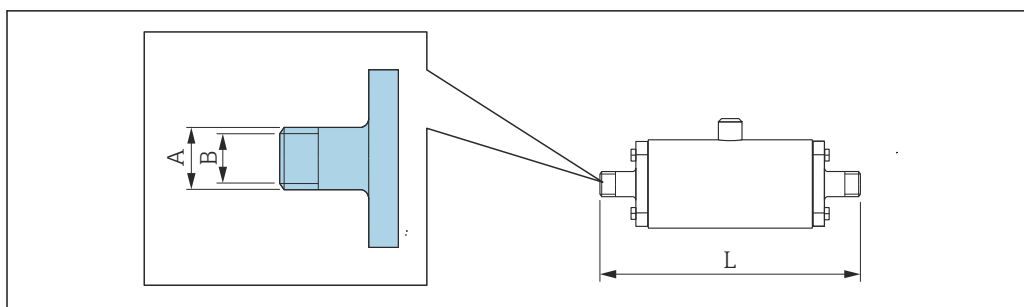

A0043227

**Coupling SC DIN 11851, thread**  
**1.4404 (316L)**  
 Order code for "Process connection", option DC

DN [mm]	Suitable for pipe EN 10357 (DIN 11850) [mm]	A [mm/in]	B [mm]	L [mm]
25	28 × 1 or 29 × 1.5	Rd 52 × 1/6	26	244

Surface roughness:  $R_a \leq 0.78 \mu\text{m}$   
 Please note the internal diameters of the measuring tube and process connection (B) when cleaning with pigs.

**Coupling DIN 11864-1, aseptic thread, Form A**  
**1.4404 (316L)**

Order code for "Process connection", option DD

DN [mm]	Suitable for pipe EN 10357 (DIN 11850) [mm]	A [mm/in]	B [mm]	L [mm]
25	29 × 1.5	Rd 52 × 1/6	26	238

Surface roughness:  $R_a \leq 0.78 \mu\text{m}$   
 Please note the internal diameters of the measuring tube and process connection (B) when cleaning with pigs.

**Coupling SMS 1145, thread**  
**1.4404 (316L)**

Order code for "Process connection", option SA

DN	Suitable for pipe ODT	A [mm/in]	B [mm]	L [mm]
1"	1"	Rd 40 × 1/6	22.6	201.6

Surface roughness:  $R_a \leq 0.78 \mu\text{m}$   
 Please note the internal diameters of the measuring tube and process connection (B) when cleaning with pigs.

**Dimensions in US units**

**Transmitter with aluminum housing**

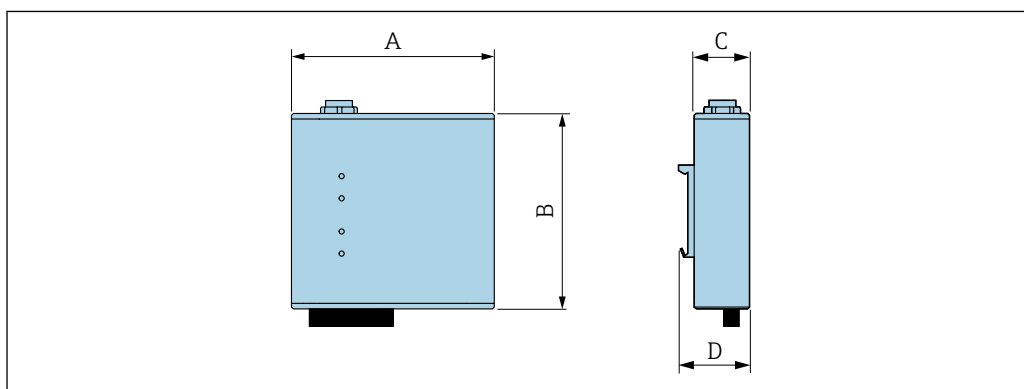

A0043203

Order code for "Transmitter housing", option A "Aluminum, brushed"

A [in]	B [in]	C [in]	D [in]
4.33	4.09	1.18	1.50

**Transmitter with stainless steel housing**

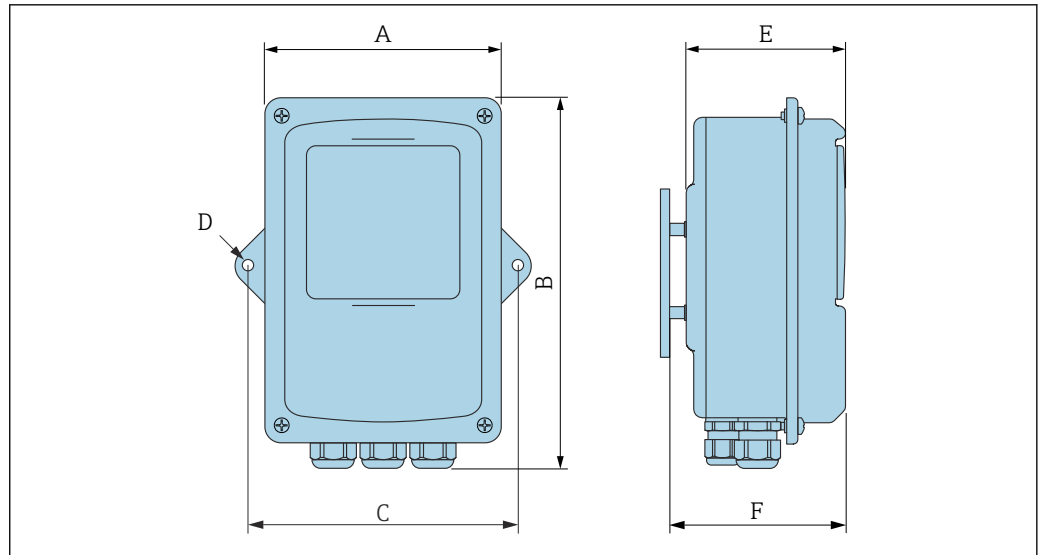

A0043204

Order code for "Transmitter housing", option B, "Stainless"

A [in]	B [in]	C [in]	D [in]	E [in]	F [in]
5.59	8.86	6.30	0.28	3.74	3.94

**Transmitter holder for mounting on posts**

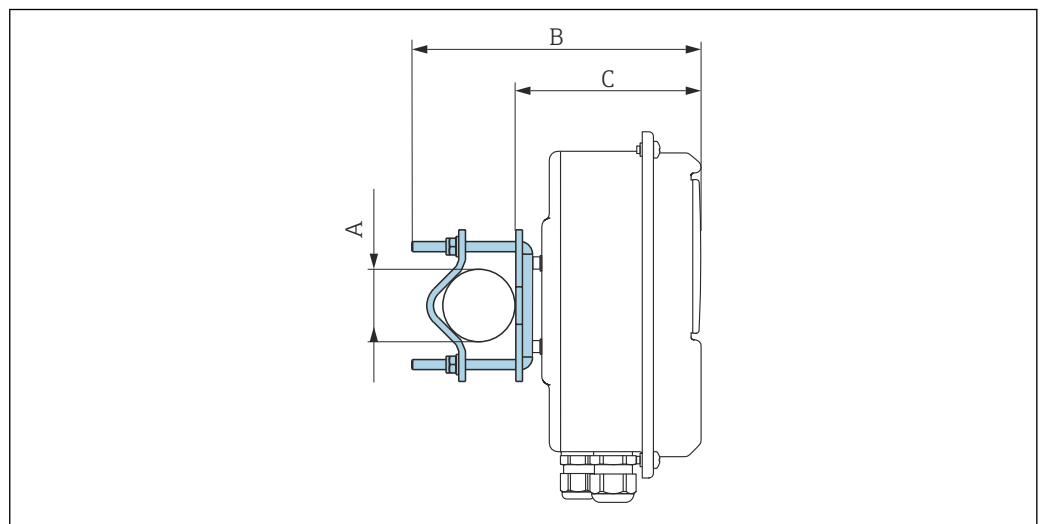

A0043202

Order code for "Accessory enclosed", option PC "Transmitter holder (pipe mounting)" or subsequently with the order number 50062121

A [in]	B [in]	C [in]
∅ max. 2.36	6.69	4.29

**Sensor**

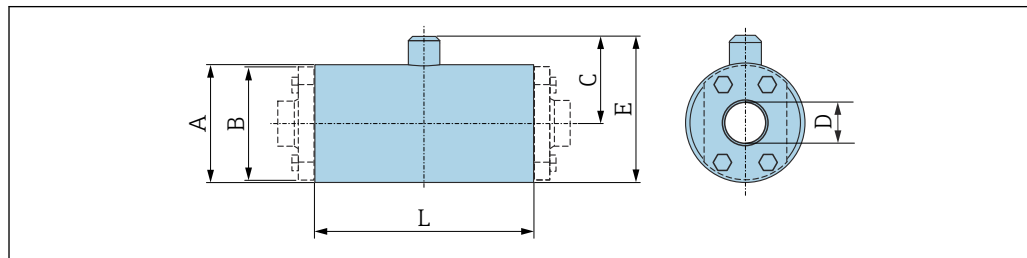

A0043225

DN	A [in]	B [in]	C [in]	D [in]	E [in]	L [in]
25 mm (DIN)	2.95	2.83	2.23	1.02	3.7	5.51
1" (ANSI)	2.95	2.83	2.23	0.89	3.7	5.51

**Clamp connections with aseptic gasket seal**

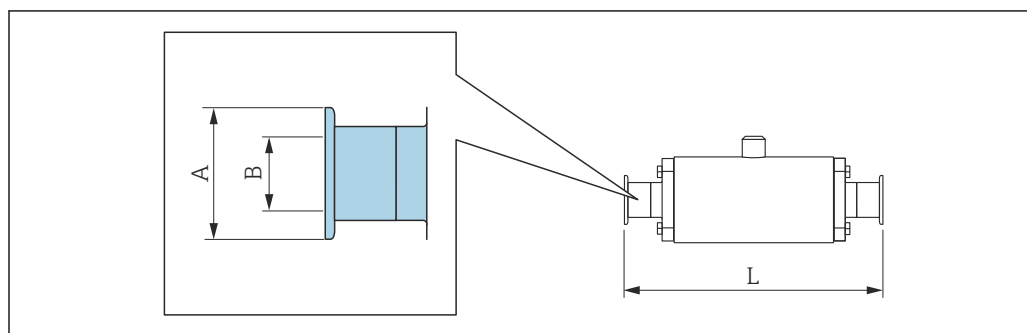

A0043226

Tri-Clamp 1.4404 (316L) Order code for "Process connection", option FA				
DN	Suitable for pipe as per ASME BPE	A [in]	B [in]	L [in]
1"	1"	2	0.87	7.76

Surface roughness:  $R_a \leq 30.71 \mu\text{in}$   
Please note the internal diameters of the measuring tube and process connection (B) when cleaning with pigs.

**Clamp according to ISO 2852, Fig. 2**  
**1.4404 (316L)**  
*Order code for "Process connection", option IB*

DN	Suitable for pipe ISO 2037 [in]	DN Clamp ISO 2852 [in]	A [in]	B [in]	L [in]
1"	1.00 × 0.06	1"	2.00	0.89	9.0

Surface roughness:  $R_a \leq 30.71 \mu\text{m}$   
 Please note the internal diameters of the measuring tube and process connection (B) when cleaning with pigs.

**Welding socket with aseptic gasket seal**

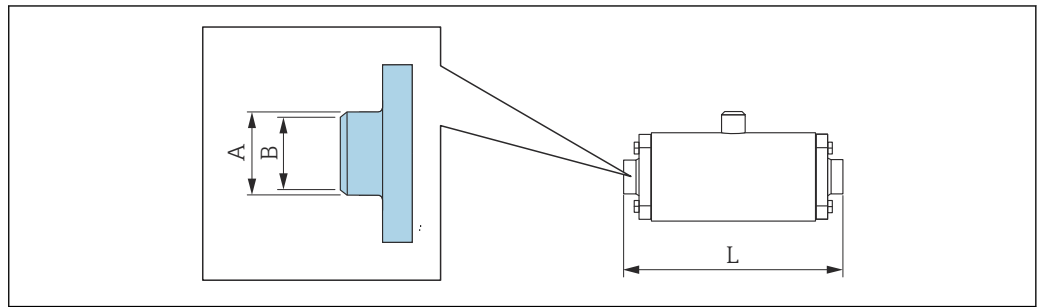

A0043230

**Welding socket according to ISO 2037**  
**1.4404 (316L)**  
*Order code for "Process connection", option IA*

DN	Suitable for pipe ISO 2037 [in]	A [in]	B [in]	L [in]
1"	1.00 × 0.06	0.98	0.89	6.78

Surface roughness:  $R_a \leq 30.71 \mu\text{m}$   
 Please note the internal diameters of the measuring tube and process connection (B) when cleaning with pigs.

**Welding socket according to ASME BPE**  
**1.4404 (316L)**  
*Order code for "Process connection", option AA*

DN	Suitable for pipe ASME BPE [in]	A [in]	B [in]	L [in]
1"	1.00 × 0.06	1.00	0.87	6.78

Surface roughness:  $R_a \leq 30.71 \mu\text{m}$   
 Please note the internal diameters of the measuring tube and process connection (B) when cleaning with pigs.

**Couplings with aseptic gasket seal**

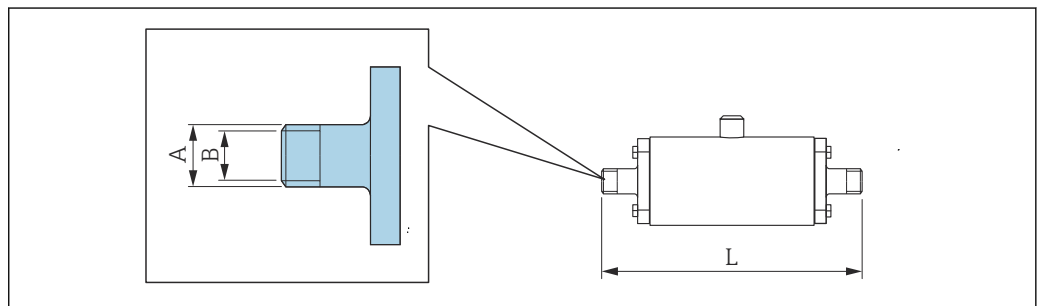

A0043227

Coupling SC DIN 11851, thread 1.4404 (316L) Order code for "Process connection", option DC				
DN	Suitable for pipe EN 10357 (DIN 11850) [in]	A [in]	B [in]	L [in]
½"	Pipe ODT ¾	Rd 0.05 × 0.13	0.63	9.61
Surface roughness: $R_a \leq 30.71 \mu\text{m}$ Please note the internal diameters of the measuring tube and process connection (B) when cleaning with pigs.				

Coupling SMS 1145, thread 1.4404 (316L) Order code for "Process connection", option SA				
DN	Suitable for pipe ODT	A [in]	B [in]	L [in]
1"	1"	Rd1.57 × 0.17	0.89	7.94
Surface roughness: $R_a \leq 30.71 \mu\text{m}$ Please note the internal diameters of the measuring tube and process connection (B) when cleaning with pigs.				

**Weight****Transmitter**

Transmitter with aluminum housing	0.34 kg (0.8 lb)
Transmitter with stainless steel housing	1.47 kg (3.24 lb)

**Sensor**

DN 25 mm (DIN)	Max. 2.42 kg (5.34 lb)
DN 1" (ANSI)	Max. 2.48 kg (5.47 lb)

The weight refers to the weight of a device with flanges. It can be lower than specified depending on the process connection.

**Materials****Transmitter housing**

*Aluminum transmitter housing, order code for "Transmitter housing", option A*

Housing	Anodized aluminum
Window material	Glass
Terminal connection	Polybuteneterephthalate (PBT)
Ethernet interface	<ul style="list-style-type: none"> <li>▪ Socket: ferrite</li> <li>▪ Contact housing: thermoplastic</li> <li>▪ Contacts: 100 % tin with nickel coating, gold-plated</li> </ul>
Push-pull connection	<ul style="list-style-type: none"> <li>▪ Socket: brass, nickel-plated</li> <li>▪ Contact housing: polyetheretherketone (PEEK)</li> <li>▪ Contacts: brass, gold-plated</li> </ul>

*Stainless steel transmitter housing, order code for "Transmitter housing", option B*

Housing	Stainless steel 1.4301 (304)
Window material	Polycarbonate
Cable glands	Stainless steel 1.4305
Terminal connection	Polybuteneterephthalate (PBT)

<b>Ethernet interface</b>	<ul style="list-style-type: none"> <li>▪ Socket: ferrite</li> <li>▪ Contact housing: thermoplastic</li> <li>▪ Contacts: 100 % tin with nickel coating, gold-plated</li> </ul>
<b>Push-pull connection</b>	<ul style="list-style-type: none"> <li>▪ Socket: brass, nickel-plated</li> <li>▪ Contact housing: polyetheretherketone (PEEK)</li> <li>▪ Contacts: brass, gold-plated</li> </ul>

**Sensor**

Stainless steel, 1.4404 (F316L)

**Connecting cable**

<b>Cable, external material</b>	Polyurethane as per DIN EN 60811-2-1 (oil-resistant, halogen-free)
<b>Push-pull connector (standard)</b>	<ul style="list-style-type: none"> <li>▪ Socket: brass, nickel-plated</li> <li>▪ Contact housing: polyetheretherketone (PEEK)</li> <li>▪ Contacts: brass, nickel, gold</li> </ul>
<b>M12 plug with the order code for "Sensor options", option CM (IP69)</b>	<ul style="list-style-type: none"> <li>▪ Socket: stainless steel</li> <li>▪ Contact housing: polyamide (PA66)</li> <li>▪ Contacts: brass, gold</li> </ul>

**Process connections**

Stainless steel, 1.4404 (F316L)

**Seals**

- EPDM
- FKM
- VMQ (silicone)

<b>Process connections</b>	<p>With aseptic gasket seal:</p> <ul style="list-style-type: none"> <li>▪ Welding socket (EN 10357 (DIN 11850), ASME BPE, ODT/SMS, ISO 2037)</li> <li>▪ Clamp (ISO 2852, DIN 32676, L14 AM7 – Tri-Clamp)</li> <li>▪ Coupling (DIN 11851, DIN 11864-1, SMS 1145)</li> <li>▪ Flange DIN 11864-2</li> </ul>
----------------------------	--

<b>Surface roughness</b>	<p>All data relate to metallic parts in contact with fluid.  <math>Ra_{max} = 0.76 \mu m</math> (30 <math>\mu in</math>) mechanically polished</p>
--------------------------	--

## Operability

<b>Local operation</b>	<p><b>Via display module</b></p> <p>Two display modules are available:</p> <ul style="list-style-type: none"> <li>▪ Order code for "Display, operation", option A: LED status indication</li> <li>▪ Order code for "Display; operation", option B: touch screen</li> </ul> <p> In the case of transmitters in a stainless steel housing, the touch screen can only be operated when the housing is open.</p>
------------------------	---

<b>Supported operating tools</b>	Operation via "Teqwave Viewer" Windows Desktop operating tool.
----------------------------------	--

<b>Reliable operation</b>	If the power supply fails, data saved in the device and device configurations are retained.
---------------------------	---

<b>Languages</b>	<p>Can be operated in the following languages:</p> <ul style="list-style-type: none"> <li>▪ Via local operation (transmitter with touch screen) English, German, French, Spanish, Italian</li> <li>▪ Via operating tool English, German, French, Spanish, Italian</li> </ul>
------------------	--

## Certificates and approvals

<b>CE mark</b>	<p>The device meets the legal requirements of the applicable EU Directives. These are listed in the corresponding EU Declaration of Conformity along with the standards applied.</p> <p>Endress+Hauser confirms successful testing of the device by affixing to it the CE mark.</p>
<b>UKCA marking</b>	<p>The device meets the legal requirements of the applicable UK regulations (Statutory Instruments). These are listed in the UKCA Declaration of Conformity along with the designated standards. By selecting the order option for UKCA marking, Endress+Hauser confirms a successful evaluation and testing of the device by affixing the UKCA mark.</p> <p>Contact address Endress+Hauser UK:          Endress+Hauser Ltd.          Floats Road          Manchester M23 9NF          United Kingdom  <a href="http://www.uk.endress.com">www.uk.endress.com</a></p>
<b>Sanitary compatibility</b>	<ul style="list-style-type: none"> <li>■ 3-A approval 28-06             <ul style="list-style-type: none"> <li>■ Confirmation by affixing the 3-A logo for measuring devices with the order code for "Additional approval", option LP "3-A".</li> <li>■ The 3-A approval refers to the sensor.</li> <li>■ Remote transmitters must be installed in accordance with the 3-A Standard.</li> <li>■ Accessories (e.g. weather protection cover, wall holder unit) must be installed in accordance with the 3-A Standard.</li> </ul> </li> <li>■ Each accessory can be cleaned. Disassembly may be necessary under certain circumstances.</li> <li>■ EHEDG Type EL Class I             <ul style="list-style-type: none"> <li>■ The EHEDG approval refers to the sensor.</li> <li>■ Confirmation by affixing the EHEDG symbol for sensors with the order code for "Additional approval", option LT "EHEDG".</li> <li>■ To meet the requirements for EHEDG certification, the sensor must be connected with process connections in accordance with the EHEDG position paper entitled "Easy Cleanable Pipe Couplings and Process Connections" (<a href="http://www.ehedg.org">www.ehedg.org</a>).</li> </ul> </li> <li>■ Food Contact Materials Regulation (EC) 1935/2004</li> <li>■ FDA: All wetted parts are in conformity with FDA requirements.</li> <li>■ Seals             <ul style="list-style-type: none"> <li>■ EPDM is not a suitable seal material for media with a fat content &gt; 8 %.</li> <li>■ FDA-compliant seals: EPDM, FKM, VMQ.</li> <li>■ EHEDG-compliant seals: EPDM, FKM.</li> </ul> </li> </ul> <p> Certificates that are currently valid are available in the Download Area of the Endress+Hauser website:</p> <ul style="list-style-type: none"> <li>■ <a href="http://www.endress.com">www.endress.com</a> → Downloads</li> <li>■ Specify the following details in the search area: Approvals &amp; certificates → Hygienic compatibility</li> </ul>
<b>Additional certification</b>	<p><b>Tests and certificates</b></p> <p>EN10204-3.1 material certificate, wetted parts</p>
<b>Other standards and guidelines</b>	<ul style="list-style-type: none"> <li>■ EN 60529 Degrees of protection provided by enclosures (IP code)</li> <li>■ EN 61010-1 Safety requirements for electrical equipment for measurement, control and laboratory use - general requirements</li> <li>■ IEC/EN 61326-2-3 Electromagnetic compatibility (EMC requirements)</li> <li>■ RoHS and IEC 63000 Restriction of hazardous substances in electric and electronic devices.</li> </ul>



## Ordering information

Detailed ordering information is available as follows:

- In the Product Configurator on the Endress+Hauser website: [www.endress.com](http://www.endress.com) -> Click "Corporate" -> Select your country -> Click "Products" -> Select the product using the filters and search field -> Open product page -> The "Configure" button to the right of the product image opens the Product Configurator.
- From your Endress+Hauser Sales Center: [www.addresses.endress.com](http://www.addresses.endress.com)



### Product Configurator - the tool for individual product configuration

- Up-to-the-minute configuration data
- Depending on the device: Direct input of measuring point-specific information such as measuring range or operating language
- Automatic verification of exclusion criteria
- Automatic creation of the order code and its breakdown in PDF or Excel output format
- Ability to order directly in the Endress+Hauser Online Shop

## Application packages

Application packages are available for the device to expand the device functions, depending on user needs. The application packages can be ordered with the device or subsequently from Endress+Hauser. The Endress+Hauser sales organization will provide detailed information on the appropriate order code. The product page of the Endress+Hauser website [www.endress.com](http://www.endress.com) also contains additional information on the order code.

Application package	Description
Viewer with interface for data download	<b>Retrieval and storage of measured data.</b> The application package allows users to retrieve measured data that are saved in the internal device memory. In addition, the measured data can be saved in a text file which can then be imported into a database. (Order number: DK9501)

## Accessories

Various accessories, which can be ordered with the device or subsequently from Endress+Hauser, are available for the device. Detailed information on the order code in question is available from your local Endress+Hauser sales center or on the product page of the Endress+Hauser website: [www.endress.com](http://www.endress.com).

### Device-specific accessories

#### For the transmitter

Accessories	Description
Transmitter	<b>Transmitter for replacement.</b> The serial number of the current transmitter must be specified when ordering. On the basis of the serial number, device-specific data in the replaced device can also be used in the new transmitter. This also includes software options and analysis parameters that are already available. Order number: DK9BXX
Transmitter holder (pipe mounting)	Transmitter holder for stainless steel housing for mounting on a post. The holder can be ordered directly with the measuring device (order code for "Accessory enclosed") or subsequently with the order number 50062121.
Sensor/transmitter connecting cable	The following cable lengths are available: <ul style="list-style-type: none"> <li>■ 1 m (3 ft)</li> <li>■ 2 m (6 ft)</li> <li>■ 5 m (15 ft)</li> <li>■ 10 m (30 ft)</li> </ul> The connecting cable can be ordered directly with the measuring device (order code for "Cable, sensor connection") or subsequently with the order number XPD0047.

**For the sensor**

Accessories	Description
Mounting kit	Mounting kit consisting of: <ul style="list-style-type: none"> <li>▪ 2 process connections</li> <li>▪ 8 screws</li> <li>▪ Seals (optional)</li> </ul> Order number: DK9HXX
Seal set	For the regular replacement of seals for the sensor. Seal set consisting of: <ul style="list-style-type: none"> <li>2 seals</li> </ul> Order number: DK9HXX

**General information**

Accessories	Description
Analysis parameters and packages of analysis parameters sorted by application	<p><b>Concentration app for the integration of new media.</b></p> <p>The concentration apps, or analysis parameters according to the area of application, are available on the DVD. The available concentration apps and analysis parameters, as well as the associated measuring ranges, are listed in the Applicator →  34.</p> <p>If you require a concentration app that is not already listed in the Applicator, Endress+Hauser requires a sample of the medium to create the concentration app. Endress+Hauser provides the concentration app as a file in lmf format. Every transmitter can use a maximum of 25 concentration apps. Concentration apps are individually tailored to a specific measuring device and can only be used with this particular device.</p> <p>Order number: DK9502</p>

**Service-specific accessories**

Accessory	Description
Applicator	<p>Software for selecting and sizing Endress+Hauser measuring devices:</p> <ul style="list-style-type: none"> <li>▪ Choice of measuring devices with industrial requirements</li> <li>▪ Overview and selection of concentration apps.</li> <li>▪ Calculation of all the necessary data for identifying the optimum flowmeter: e.g. nominal diameter, pressure loss, flow velocity and accuracy.</li> <li>▪ Graphic illustration of the calculation results</li> <li>▪ Determination of the partial order code, administration, documentation and access to all project-related data and parameters over the entire life cycle of a project.</li> </ul> <p>Applicator is available:</p> <ul style="list-style-type: none"> <li>▪ Via the Internet: <a href="https://portal.endress.com/webapp/applicator">https://portal.endress.com/webapp/applicator</a></li> <li>▪ As a downloadable DVD for local PC installation.</li> </ul>
W@M	<p>W@M Life Cycle Management</p> <p>Improved productivity with information at your fingertips. Data relevant to a plant and its components is generated from the first stages of planning and during the asset's complete life cycle.</p> <p>W@M Life Cycle Management is an open and flexible information platform with online and on-site tools. Instant access for your staff to current, in-depth data shortens your plant's engineering time, speeds up procurement processes and increases plant uptime.</p> <p>Combined with the right services, W@M Life Cycle Management boosts productivity in every phase. For more information, see: <a href="http://www.endress.com/lifecyclemanagement">www.endress.com/lifecyclemanagement</a></p>

**Documentation**

-  For an overview of the scope of the associated Technical Documentation, refer to the following:
- *W@M Device Viewer* ([www.endress.com/deviceviewer](http://www.endress.com/deviceviewer)): Enter the serial number from the nameplate
  - *Endress+Hauser Operations App*: Enter the serial number from the nameplate or scan the matrix code on the nameplate

**Standard documentation**

Document type	Documentation code
Operating Instructions	BA02084D
Brief Operating Instructions	KA01501D

## Registered trademarks

**Modbus®**

Registered trademark of SCHNEIDER AUTOMATION, INC.

**TRI-CLAMP®**

Registered trademark of Ladish & Co., Inc., Kenosha, USA



71554682

[www.addresses.endress.com](http://www.addresses.endress.com)

---