

# Operating Instructions

## Teqwave H

Ultrasonic concentration meter  
Modbus TCP

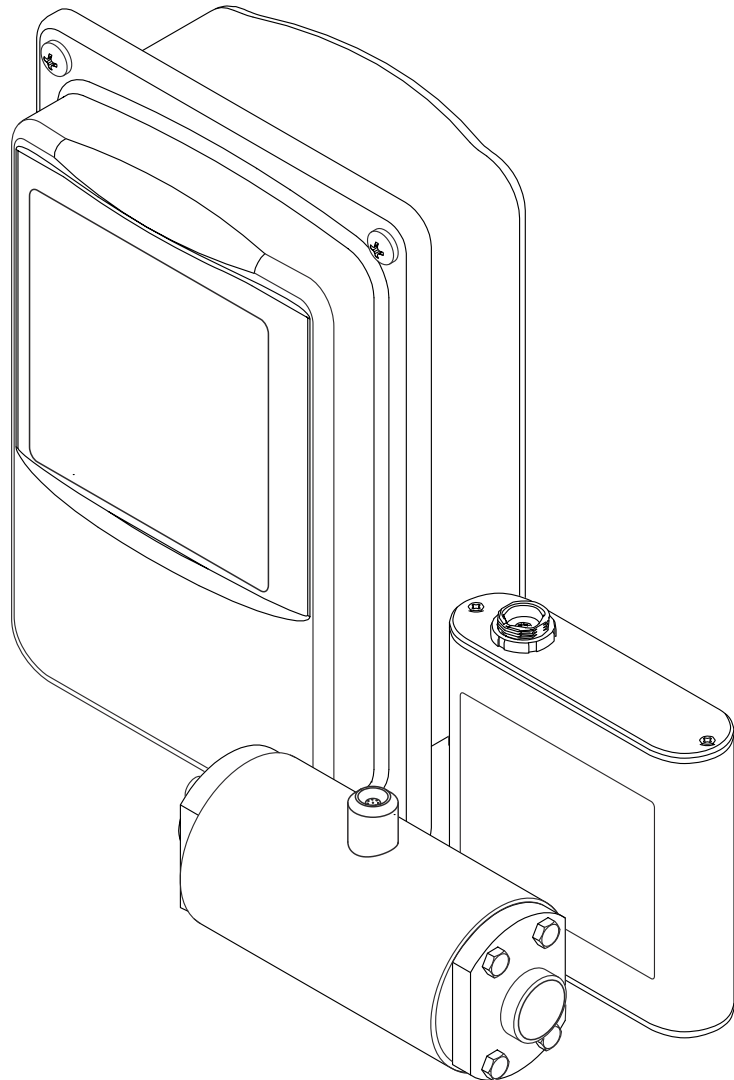

- Make sure the document is stored in a safe place such that it is always available when working on or with the device.
- To avoid danger to individuals or the facility, read the "Basic safety instructions" section carefully, as well as all other safety instructions in the document that are specific to working procedures.
- The manufacturer reserves the right to modify technical data without prior notice. Your Endress+Hauser Sales Center will supply you with current information and updates to these instructions.

## Table of contents

<b>1</b>	<b>About this document</b> . . . . .	<b>6</b>		
1.1	Document function . . . . .	6		
1.2	Symbols . . . . .	6		
1.2.1	Safety symbols . . . . .	6		
1.2.2	Electrical symbols . . . . .	6		
1.2.3	Symbols for certain types of information . . . . .	7		
1.2.4	Symbols in graphics . . . . .	7		
1.3	Documentation . . . . .	7		
1.3.1	Standard documentation . . . . .	8		
1.3.2	Supplementary device-dependent documentation . . . . .	8		
1.4	Registered trademarks . . . . .	8		
<b>2</b>	<b>Basic safety instructions</b> . . . . .	<b>9</b>		
2.1	Requirements for the personnel . . . . .	9		
2.2	Designated use . . . . .	9		
2.2.1	Application and media . . . . .	9		
2.2.2	Incorrect use . . . . .	9		
2.2.3	Residual risks . . . . .	9		
2.3	Workplace safety . . . . .	9		
2.4	Operational safety . . . . .	10		
2.5	Product safety . . . . .	10		
2.6	IT security . . . . .	10		
<b>3</b>	<b>Product description</b> . . . . .	<b>11</b>		
3.1	Product design . . . . .	11		
3.1.1	Measuring device with transmitter in aluminum housing . . . . .	11		
3.1.2	Measuring device with transmitter in stainless steel housing . . . . .	12		
3.2	Concentration apps . . . . .	12		
3.3	Applications . . . . .	13		
<b>4</b>	<b>Incoming acceptance and product identification</b> . . . . .	<b>14</b>		
4.1	Incoming acceptance . . . . .	14		
4.2	Product identification . . . . .	14		
4.2.1	Transmitter nameplate . . . . .	15		
4.2.2	Sensor nameplate . . . . .	16		
4.2.3	Symbols on measuring device . . . . .	17		
<b>5</b>	<b>Storage and transport</b> . . . . .	<b>19</b>		
5.1	Storage conditions . . . . .	19		
5.2	Transporting the product . . . . .	19		
5.3	Packaging disposal . . . . .	19		
<b>6</b>	<b>Mounting</b> . . . . .	<b>20</b>		
6.1	Installation conditions . . . . .	20		
6.1.1	Mounting position . . . . .	20		
6.1.2	Environment and process requirements . . . . .	20		
6.1.3	Special mounting instructions . . . . .	21		
6.2	Mounting the measuring device . . . . .	21		
6.2.1	Mounting the sensor . . . . .	21		
6.2.2	Mounting the transmitter . . . . .	21		
6.3	Post-installation check . . . . .	23		
<b>7</b>	<b>Electrical connection</b> . . . . .	<b>24</b>		
7.1	Connecting requirements . . . . .	24		
7.1.1	Requirements for connecting cable . . . . .	24		
7.1.2	Terminal assignment . . . . .	24		
7.1.3	Requirements for the supply unit . . . . .	25		
7.2	Connecting the measuring device: transmitter with aluminum housing . . . . .	25		
7.2.1	Connecting the connecting cable . . . . .	25		
7.2.2	Connecting the signal and supply voltage cables . . . . .	26		
7.2.3	Ensuring potential equalization . . . . .	26		
7.3	Connecting the measuring device: transmitter with stainless steel housing . . . . .	26		
7.3.1	Opening the housing cover . . . . .	26		
7.3.2	Connecting the connecting cable . . . . .	27		
7.3.3	Connecting the signal and supply voltage cables . . . . .	27		
7.3.4	Ensuring potential equalization . . . . .	28		
7.3.5	Closing the housing cover . . . . .	28		
7.4	Special connection instructions . . . . .	29		
7.4.1	Connection examples . . . . .	29		
7.5	Post-connection check . . . . .	30		
<b>8</b>	<b>Operation options</b> . . . . .	<b>31</b>		
8.1	Overview of the operation options . . . . .	31		
8.2	Access to the measuring device via the local display . . . . .	31		
8.2.1	Operational display of the transmitter with a touch screen . . . . .	31		
8.2.2	LED status indication (transmitter with LED status indication) . . . . .	33		
8.3	Access to the measuring device via the operating tool . . . . .	33		
8.3.1	System requirements . . . . .	34		
8.3.2	Software installation . . . . .	34		
8.3.3	Establishing a connection for the transmitter - Viewer Internet protocol . . . . .	34		
8.3.4	User interface . . . . .	36		
8.3.5	General control and operating elements . . . . .	38		
<b>9</b>	<b>System integration</b> . . . . .	<b>39</b>		
9.1	Overview of device description files . . . . .	39		

9.2	Modbus TCP information . . . . .	39	11.7	Reading the device memory and saving measured data . . . . .	65
9.2.1	General settings for the Modbus interface . . . . .	39	11.7.1	Reading measured data from the transmitter . . . . .	65
9.2.2	Function codes . . . . .	39	11.7.2	Saving the read measured data to a .csv file . . . . .	65
9.2.3	Register information . . . . .	39	11.7.3	Deleting saved measured data from the transmitter . . . . .	65
<b>10</b>	<b>Commissioning . . . . .</b>	<b>42</b>	11.8	Managing concentration apps . . . . .	66
10.1	Function check . . . . .	42	11.8.1	Adding a concentration app to the transmitter . . . . .	66
10.2	Switching on the measuring device . . . . .	42	11.8.2	Deleting a concentration app from the transmitter . . . . .	66
10.3	Setting the operating language . . . . .	42	11.9	Replacing the transmitter . . . . .	66
10.4	Configuring the measuring device . . . . .	43	11.10	Updating the firmware . . . . .	67
10.4.1	Selecting the concentration app . . . . .	43	<b>12</b>	<b>Diagnostics and troubleshooting . . . . .</b>	<b>68</b>
10.4.2	Configuring the measuring unit . . . . .	43	12.1	General troubleshooting . . . . .	68
10.4.3	Configuring the analog output . . . . .	44	12.1.1	For the local display: transmitter with touch screen . . . . .	68
10.4.4	Displaying calibration ranges . . . . .	46	12.1.2	For the local display: transmitter with LEDs . . . . .	68
10.4.5	Configuring the measuring range . . . . .	46	12.1.3	For output signals . . . . .	68
10.4.6	Configuring the switch output . . . . .	47	12.1.4	For access via the "Teqwave Viewer" operating tool . . . . .	69
10.4.7	Configuring the measured value display . . . . .	49	12.2	Diagnostics information for transmitter with LED status indication . . . . .	69
10.4.8	Configuring the touch screen . . . . .	50	12.3	Diagnostic information on local display and in operating tool . . . . .	70
10.4.9	Configuring the failsafe mode . . . . .	52	12.4	Diagnostics information for transmitter with LED status indication . . . . .	71
10.5	Advanced settings . . . . .	54	12.5	Diagnostic information via dispersion indicator . . . . .	72
10.5.1	Recipe generator . . . . .	54	12.6	Testing the sensor . . . . .	72
10.5.2	Setting the compensation values . . . . .	56	12.7	Resetting the measuring device to factory default settings . . . . .	73
10.5.3	Setting the concentration offset . . . . .	57	12.7.1	Restoring factory settings via transmitter with touch screen . . . . .	73
10.5.4	Performing field calibration with a medium . . . . .	57	12.7.2	Restoring factory settings via the Viewer . . . . .	73
10.6	Application package "Viewer with interface for data download" . . . . .	59	12.8	Device information . . . . .	73
10.6.1	Availability . . . . .	59	12.9	Firmware history . . . . .	74
10.6.2	Activation . . . . .	59	<b>13</b>	<b>Maintenance . . . . .</b>	<b>75</b>
10.6.3	General information . . . . .	59	13.1	Maintenance tasks . . . . .	75
10.6.4	Device memory disk space . . . . .	59	13.1.1	Exterior cleaning . . . . .	75
10.6.5	Specifying the storage interval . . . . .	59	13.1.2	Interior cleaning . . . . .	75
<b>11</b>	<b>Operation . . . . .</b>	<b>61</b>	13.1.3	Replacing seals . . . . .	75
11.1	Changing the operating language . . . . .	61	13.2	Endress+Hauser services . . . . .	75
11.2	Configuring the local display . . . . .	61	<b>14</b>	<b>Repair . . . . .</b>	<b>76</b>
11.3	Reading measured values via the local display . . . . .	61	14.1	General information . . . . .	76
11.3.1	Reading measured values . . . . .	61	14.1.1	Repair and conversion concept . . . . .	76
11.3.2	Adjusting the graph display format . . . . .	61	14.1.2	Notes for repair and conversion . . . . .	76
11.3.3	Graph tools . . . . .	62	14.2	Spare parts . . . . .	76
11.4	Reading measured values via the operating tool . . . . .	62	14.3	Endress+Hauser services . . . . .	76
11.4.1	Reading measured values . . . . .	62	14.4	Return . . . . .	76
11.4.2	Adjusting the graph display format . . . . .	62			
11.4.3	Graph tools . . . . .	63			
11.4.4	Switching auto scale on and off . . . . .	64			
11.4.5	Clearing the graph . . . . .	64			
11.5	Accessing measured data via the operating tool . . . . .	64			
11.5.1	Saving the current measuring point to a .csv file . . . . .	64			
11.5.2	Recording measuring points . . . . .	64			
11.5.3	Stop recording . . . . .	64			
11.6	Opening measured data in the Graph View . . . . .	64			
11.6.1	Opening the measured data . . . . .	64			

---

14.5	Disposal .....	77
14.5.1	Removing the measuring device .....	77
14.5.2	Disposing of the measuring device ...	77
<b>15</b>	<b>Accessories .....</b>	<b>78</b>
15.1	Device-specific accessories .....	78
15.1.1	For the transmitter .....	78
15.1.2	For the sensor .....	78
15.1.3	General information .....	78
15.2	Service-specific accessories .....	79
<b>16</b>	<b>Technical data .....</b>	<b>80</b>
16.1	Application .....	80
16.2	Function and system design .....	80
16.3	Input .....	80
16.4	Output .....	81
16.5	Power supply .....	83
16.6	Performance characteristics .....	84
16.7	Installation .....	85
16.8	Environment .....	85
16.9	Process .....	86
16.10	Mechanical construction .....	86
16.11	Operability .....	88
16.12	Certificates and approvals .....	88
16.13	Application packages .....	89
16.14	Accessories .....	90
16.15	Documentation .....	90
<b>Index</b> .....	<b>91</b>	

# 1 About this document

## 1.1 Document function

These Operating Instructions contain all the information that is required in various phases of the life cycle of the device: from product identification, incoming acceptance and storage, to mounting, connection, operation and commissioning through to troubleshooting, maintenance and disposal.

## 1.2 Symbols

### 1.2.1 Safety symbols

#### DANGER

This symbol alerts you to a dangerous situation. Failure to avoid this situation will result in serious or fatal injury.

#### WARNING

This symbol alerts you to a dangerous situation. Failure to avoid this situation can result in serious or fatal injury.







#### CAUTION

This symbol alerts you to a dangerous situation. Failure to avoid this situation can result in minor or medium injury.













#### NOTICE

This symbol contains information on procedures and other facts which do not result in personal injury.







### 1.2.2 Electrical symbols

Symbol	Meaning
	Direct current
	Alternating current
	Direct current and alternating current
	<b>Ground connection</b> A grounded terminal which, as far as the operator is concerned, is grounded via a grounding system.
	<b>Potential equalization connection (PE: protective earth)</b> Ground terminals that must be connected to ground prior to establishing any other connections.  The ground terminals are located on the interior and exterior of the device: <ul style="list-style-type: none"> <li>▪ Interior ground terminal: potential equalization is connected to the supply network.</li> <li>▪ Exterior ground terminal: device is connected to the plant grounding system.</li> </ul>
	<b>Signal ground connection</b> A terminal that can be used as a ground contact for the digital input.
	<b>Switch output connection</b> A terminal that can be used as a switch output.

### 1.2.3 Symbols for certain types of information

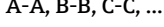

Symbol	Meaning
	<b>Permitted</b> Procedures, processes or actions that are permitted.
	<b>Preferred</b> Procedures, processes or actions that are preferred.
	<b>Forbidden</b> Procedures, processes or actions that are forbidden.
	<b>Tip</b> Indicates additional information.
	Reference to documentation
	Reference to page
	Reference to graphic
	Notice or individual step to be observed
	Series of steps
	Result of a step
	Help in the event of a problem
	Visual inspection

### 1.2.4 Symbols in graphics

Symbol	Meaning
	Item numbers
	Series of steps
	Views
	Sections
	Hazardous area
	Safe area (non-hazardous area)
	Flow direction

## 1.3 Documentation

-  For an overview of the scope of the associated Technical Documentation, refer to the following:
  - *W@M Device Viewer* ([www.endress.com/deviceviewer](http://www.endress.com/deviceviewer)): Enter the serial number from the nameplate
  - *Endress+Hauser Operations App*: Enter the serial number from the nameplate or scan the matrix code on the nameplate

-  Detailed list of the individual documents along with the documentation code  
→  90

### 1.3.1 Standard documentation

Document type	Purpose and content of the document
Technical Information	<b>Planning aid for your device</b> The document contains all the technical data on the device and provides an overview of the accessories and other products that can be ordered for the device.
Brief Operating Instructions	<b>Getting the 1st measured value quickly</b> The Brief Operating Instructions contain all the essential information from incoming acceptance to initial commissioning.

### 1.3.2 Supplementary device-dependent documentation

Additional documents are supplied depending on the device version ordered: Always comply strictly with the instructions in the supplementary documentation. The supplementary documentation is an integral part of the device documentation.

## 1.4 Registered trademarks

### **Modbus®**

Registered trademark of SCHNEIDER AUTOMATION, INC.

### **TRI-CLAMP®**

Registered trademark of Ladish & Co., Inc., Kenosha, USA



## 2 Basic safety instructions

### 2.1 Requirements for the personnel

The personnel for installation, commissioning, diagnostics and maintenance must fulfill the following requirements:

- ▶ Trained, qualified specialists must have a relevant qualification for this specific function and task.
- ▶ Are authorized by the plant owner/operator.
- ▶ Are familiar with federal/national regulations.
- ▶ Before starting work, read and understand the instructions in the manual and supplementary documentation as well as the certificates (depending on the application).
- ▶ Follow instructions and comply with basic conditions.

The operating personnel must fulfill the following requirements:

- ▶ Are instructed and authorized according to the requirements of the task by the facility's owner-operator.
- ▶ Follow the instructions in this manual.

### 2.2 Designated use

#### 2.2.1 Application and media

Only use the measuring device described in these Operating Instructions for the measurement of liquids and liquid analysis.

Only operate the measuring device within the limits specified in the technical data and for the specific concentration app.

To ensure that the measuring device remains in proper condition for the operation time:

- ▶ Only use the measuring device for media to which the process-wetted materials are sufficiently resistant.

#### 2.2.2 Incorrect use

Non-designated use can compromise safety. The manufacturer is not liable for damage caused by improper or non-designated use.

#### 2.2.3 Residual risks

##### **WARNING**

**Hot media can present a burn hazard.**

- ▶ In the event of elevated medium temperatures, ensure protection against contact to prevent burns.

### 2.3 Workplace safety

For work on and with the device:

- ▶ Wear the required personal protective equipment according to national regulations.

For welding work on the piping:

- ▶ Do not ground the welding unit via the measuring device.

## 2.4 Operational safety

Risk of injury.

- ▶ Operate the device in proper technical condition and fail-safe condition only.
- ▶ The operator is responsible for interference-free operation of the device.

### Conversions to the device

Unauthorized modifications to the device are not permitted and can lead to unforeseeable dangers.

- ▶ If, despite this, modifications are required, consult with Endress+Hauser.

### Repair

To ensure continued operational safety and reliability,

- ▶ Carry out repairs on the device only if they are expressly permitted.
- ▶ Observe federal/national regulations pertaining to repair of an electrical device.
- ▶ Use original spare parts and accessories from Endress+Hauser only.

## 2.5 Product safety

This measuring device is designed in accordance with good engineering practice to meet state-of-the-art safety requirements, has been tested, and left the factory in a condition in which it is safe to operate.

It meets general safety standards and legal requirements. It also complies with the EU directives listed in the device-specific EU Declaration of Conformity.

Furthermore, the device meets the legal requirements of the applicable UK regulations (Statutory Instruments). These are listed in the UKCA Declaration of Conformity along with the designated standards.

By selecting the order option for UKCA marking, Endress+Hauser confirms a successful evaluation and testing of the device by affixing the UKCA mark.

Contact address Endress+Hauser UK:

Endress+Hauser Ltd.  
Floats Road  
Manchester M23 9NF  
United Kingdom  
[www.uk.endress.com](http://www.uk.endress.com)

## 2.6 IT security

Our warranty is valid only if the device is installed and used as described in the Operating Instructions. The device is equipped with security mechanisms to protect it against any inadvertent changes to the settings.

IT security measures, which provide additional protection for the device and associated data transfer, must be implemented by the operators themselves in line with their security standards.

### 3 Product description

The measuring system consists of a sensor and a transmitter. The sensor and transmitter are mounted in physically separate locations. A connecting cable with a push-pull or M12 plug interconnects the sensor and transmitter.

The measuring system uses concentration apps, which are individually tailored to the measurement task and encoded to work only with the serial number of a specific transmitter.

#### 3.1 Product design

Several transmitter versions are available.

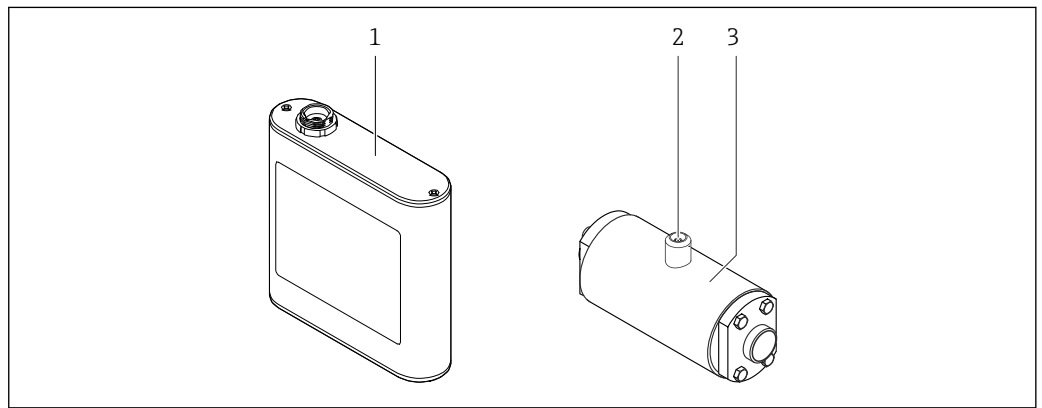

##### 3.1.1 Measuring device with transmitter in aluminum housing



A0043280

#### 1 Important components of the measuring device

- 1 Transmitter in aluminum transmitter housing with LED status indication or touch screen and push-pull connection for connecting to the sensor, terminal strip and Ethernet interface
- 2 Push-pull or M12 connection for connecting to the transmitter
- 3 Sensor

 Only use the connecting cable supplied. The connecting cable can be ordered subsequently as an accessory →  78.

### 3.1.2 Measuring device with transmitter in stainless steel housing

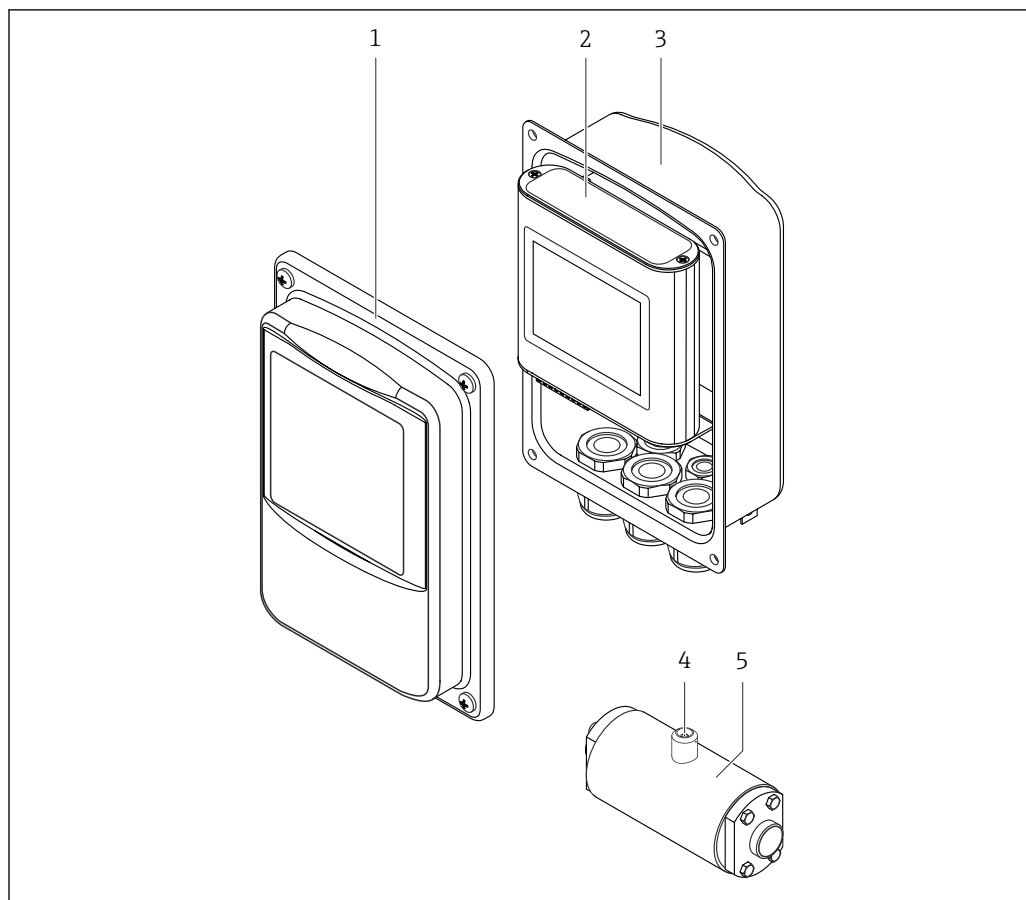

A0043281

#### 2 Important components of the measuring device

- 1 Stainless steel housing cover with viewing window
- 2 Transmitter with touch screen and push-pull connection for connecting to the sensor, terminal strip and Ethernet interface
- 3 Stainless steel housing with cable entries
- 4 Push-pull or M12 connection for connecting to the transmitter
- 5 Sensor

 Only use the connecting cable supplied. The connecting cable can be ordered subsequently as an accessory →  78.

## 3.2 Concentration apps

Endress+Hauser provides a separate concentration app for every medium. A concentration app contains the necessary specific characteristics of speed of sound and acoustic density in a defined temperature range, which are required to calculate the concentration and other analysis parameters (e.g. the degree of inversion of sugar) of a liquid.

 The available concentration apps and analysis parameters, as well as the associated measuring ranges, are listed in the Applicator.

With the "Teqwave Viewer" operating tool, it is also possible to customize a concentration app to specific customer requirements and save the changes as a recipe. Furthermore, the accuracy of the analysis parameters of certain concentration apps can be improved by integrating additional external or entered measured values (e.g. pressure).

Apart from the preconfigured concentration apps which are available by default, Endress+Hauser also creates individual concentration apps specifically for your application.

 Your Endress+Hauser sales organization can provide detailed information on this service.

Every transmitter can manage a maximum of 25 concentration apps or recipes.

The data sheet provided with a concentration app contains information about the medium, the analysis parameters, the permitted measuring ranges, the compensation values and the accuracy of the concentration measurement.

### 3.3 Applications

Packages with multiple concentration apps can be ordered for the measuring device either during the initial purchase or subsequently. The concentration apps are grouped by application area and enable the measurement of analysis parameters (e.g. concentration of sugar and alcohol) of different media in an industry, e.g. in distilleries or the production of soft drinks.

 For information on the concentration apps contained in the areas of application and the associated measuring ranges, see the "Technical Information" document, "Measuring ranges" section.

## 4 Incoming acceptance and product identification

### 4.1 Incoming acceptance

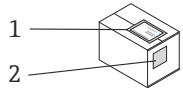
Is the order code on the delivery note (1) identical to the order code on the product sticker (2)?		<input type="checkbox"/>
Is the measuring device undamaged?		<input type="checkbox"/>
Do the nameplate data match the ordering information on the delivery note?		<input type="checkbox"/>
Is a DVD provided with the "Teqwave Viewer" software?		<input type="checkbox"/>
Is a CD-ROM provided with the Technical Documentation (depends on device version) and documents?		<input type="checkbox"/>



- i**
- If one of the conditions is not satisfied, contact your Endress+Hauser Sales Center.
  - The Technical Documentation is available via the Internet or via the *Endress+Hauser Operations App*, see the "Product identification" section →  14.

### 4.2 Product identification

The following options are available for identification of the device:

- Nameplate specifications
- Order code with breakdown of the device features on the delivery note
- Enter the serial numbers from the nameplates in *W@M Device Viewer* ([www.endress.com/deviceviewer](http://www.endress.com/deviceviewer)): all the information about the device is displayed.
- Enter the serial numbers from the nameplates into the *Endress+Hauser Operations App* or scan the DataMatrix code on the nameplate with the *Endress+Hauser Operations App*: all the information about the device is displayed.

For an overview of the scope of the associated Technical Documentation, refer to the following:

- The chapters "Additional standard documentation on the device" →  8 and "Supplementary device-dependent documentation" →  8
- The *W@M Device Viewer*: Enter the serial number from the nameplate ([www.endress.com/deviceviewer](http://www.endress.com/deviceviewer))
- The *Endress+Hauser Operations App*: Enter the serial number from the nameplate or scan the DataMatrix code on the nameplate.

### 4.2.1 Transmitter nameplate

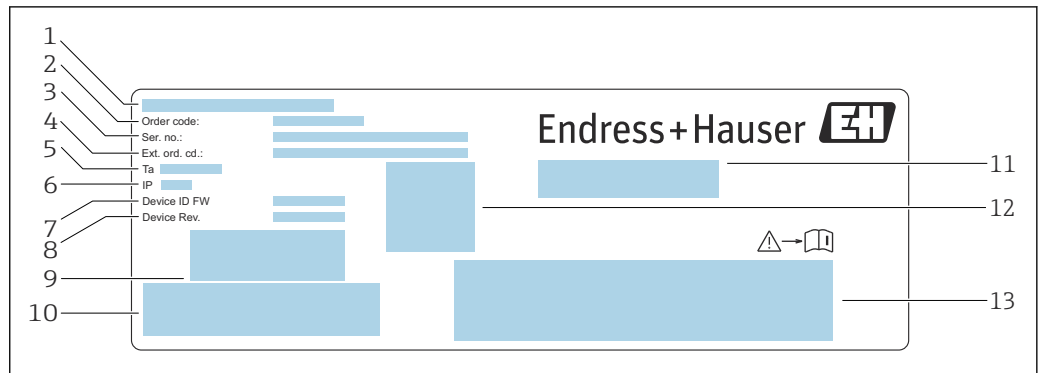

A0035638

3 Example of a nameplate for a transmitter with an aluminum housing

- 1 Place of manufacture
- 2 Order code
- 3 Serial number (Ser. no.)
- 4 Extended order code (Ext. ord. cd.)
- 5 Permitted ambient temperature ( $T_a$ )
- 6 Degree of protection
- 7 Firmware version (Device ID FW) ex works
- 8 Hardware version (Device Rev.) ex works
- 9 Barcode for internal use
- 10 Barcode for internal use
- 11 Name of the measuring device
- 12 2D matrix code with serial number
- 13 Space for approvals and certificates

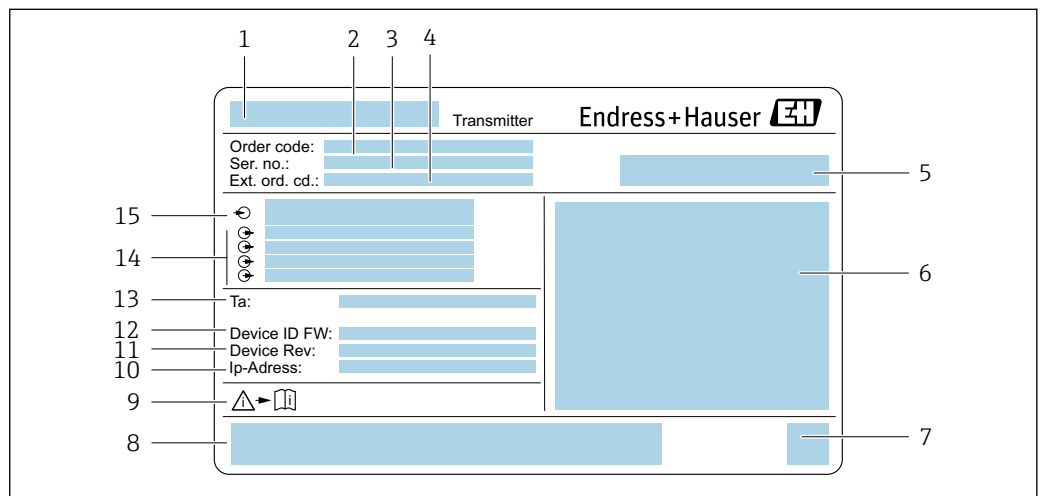

A0044691

4 Example of a nameplate for a transmitter with a stainless steel housing

- 1 Name of the measuring device
- 2 Order code
- 3 Serial number (Ser. no.)
- 4 Extended order code (Ext. ord. cd.)
- 5 Place of manufacture
- 6 Degree of protection
- 7 2D matrix code with serial number
- 8 Space for approvals and certificates: e.g. CE mark
- 9 Observe device documentation
- 10 IP address ex works
- 11 Hardware version (Device Rev.) ex works
- 12 Firmware version (Device ID FW) ex works
- 13 Permitted ambient temperature ( $T_a$ )
- 14 Available inputs and outputs
- 15 Supply voltage

## 4.2.2 Sensor nameplate

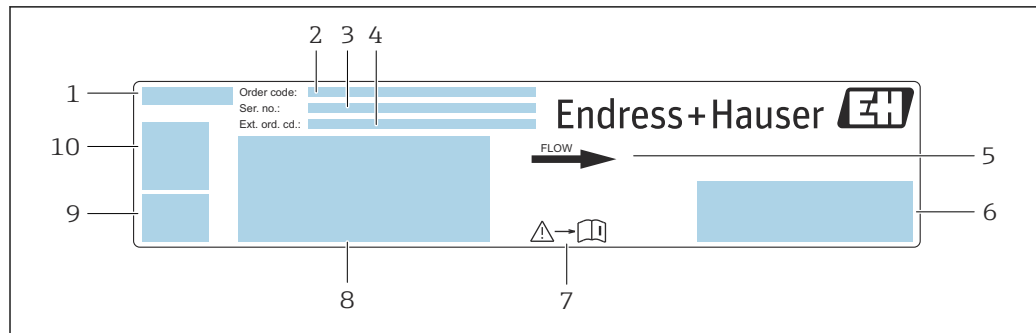

A0044853

5 Example of a nameplate for a sensor with IP 67 degree of protection

- 1 Name of the measuring device
- 2 Order code
- 3 Serial number (Ser. no.)
- 4 Extended order code (Ext. ord. cd.)
- 5 Flow direction
- 6 Space for approvals and certificates: e.g. CE mark
- 7 Observe device documentation
- 8 Degree of protection, max. flow (Q<sub>max</sub>); nominal diameter of the sensor/pressure rating (PN=PS); permitted ambient temperature (T<sub>a</sub>); permitted medium temperature (T<sub>m</sub>); measuring pipe material
- 9 Place of manufacture
- 10 2D matrix code with serial number



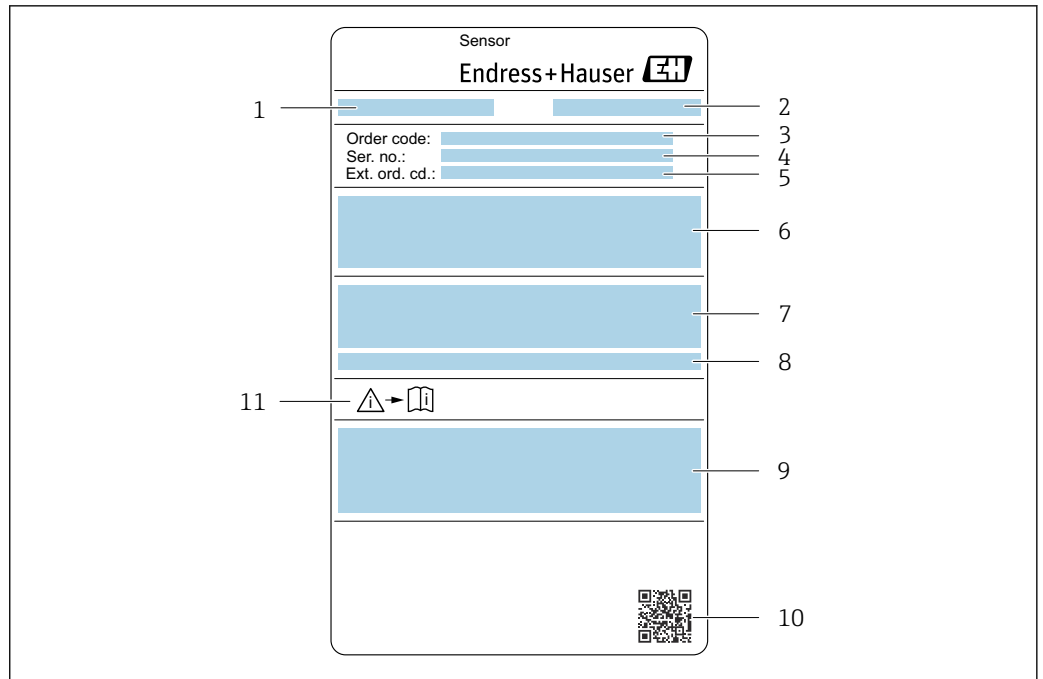

A0044684

6 Example of a nameplate for a sensor with IP 69 degree of protection

- 1 Name of the measuring device
- 2 Place of manufacture
- 3 Order code
- 4 Serial number (ser. no.)
- 5 Extended order code (Ext. ord. cd.)
- 6 Nominal diameter of the sensor; speed of sound; density; pressure rating (PN=PS); medium temperature range (Tm); measuring pipe material
- 7 Degree of protection
- 8 Permitted ambient temperature (T<sub>a</sub>)
- 9 Space for approvals and certificates: e.g. CE mark
- 10 2D matrix code with serial number
- 11 Observe device documentation

**i Order code**

The measuring device is reordered using the order code.



**Extended order code**

- The device type (product root) and basic specifications (mandatory features) are always listed.
- Of the optional specifications (optional features), only the safety and approval-related specifications are listed (e.g. LA). If other optional specifications are also ordered, these are indicated collectively using the # placeholder symbol (e.g. #LA#).
- If the ordered optional specifications do not include any safety and approval-related specifications, they are indicated by the + placeholder symbol (e.g. XXXXXX-ABCDE+).

**4.2.3 Symbols on measuring device**

Symbol	Meaning
	<b>WARNING</b> This symbol alerts you to a life-threatening situation. Failure to avoid this situation can result in serious or fatal injury. Please consult the document for the measuring device to discover the type of potential danger and measures to avoid it.
	<b>Reference to documentation</b> Refers to the corresponding measuring device documentation.

A0011194

Symbol	Meaning
 A0035455	<b>Signal ground connection</b> A terminal that can be used as a ground contact for the digital input.
 A0035456	<b>Switch output connection</b> A terminal that can be used as a switch output.

## 5 Storage and transport

### 5.1 Storage conditions

Observe the following notes for storage:

- Store in the original packaging to ensure protection from shock.
- Protect from direct sunlight to avoid unacceptably high surface temperatures.
- Store in a dry and dust-free place.
- Do not store outdoors.

Storage temperature →  85.

### 5.2 Transporting the product

- Transport the measuring device to the measuring point in the original packaging.
- Do not remove protective covers or caps installed on process connections.

### 5.3 Packaging disposal

All packaging materials are environmentally friendly and 100 % recyclable: box in accordance with European Packaging Directive 94/62/EC; recyclability is confirmed by the affixed RESY symbol.

## 6 Mounting

### 6.1 Installation conditions

#### 6.1.1 Mounting position

##### Mounting location

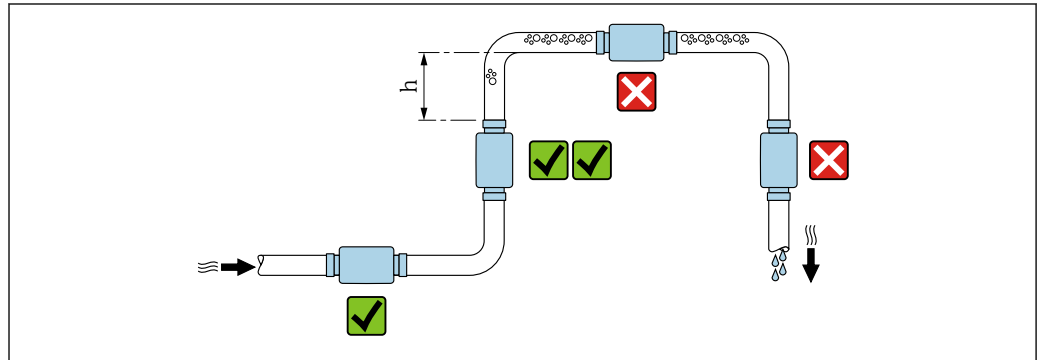

A0032998

7 Mounting location

Preferably install the sensor in an ascending pipe, and ensure a sufficient distance to the next pipe elbow:  $h \geq 5 \times DN$ .

##### Inlet and outlet runs

Observe the following inlet and outlet runs to comply with accuracy specifications:

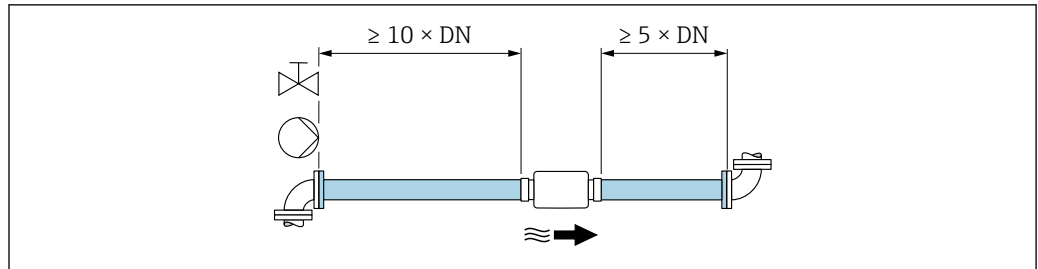

A0035458

8 Inlet and outlet runs

#### 6.1.2 Environment and process requirements

##### Ambient temperature range

Sensor	0 to +60 °C (+32 to +140 °F)
Transmitter	0 to +60 °C (+32 to +140 °F)

If operating outdoors:

- Install the measuring device in a shady location.
- Avoid direct sunlight, particularly in warm climatic regions.
- Avoid direct exposure to weather conditions.

### 6.1.3 Special mounting instructions

#### Hygienic compatibility

If installing in hygienic applications:

- Observe the instructions in the "Certificates and approvals/hygienic compatibility" section →  89.
- Ensure that liquid cannot accumulate on the outside of the measuring device.
- If the measuring device is installed horizontally, align the connection socket for the connecting so it is pointing upwards.
- Select the orientation in such a way that the measuring device is self-draining when installed. Installation with an angle of inclination  $>3^\circ$  is recommended for this purpose.

## 6.2 Mounting the measuring device

### 6.2.1 Mounting the sensor

#### WARNING

##### Danger due to improper process sealing!

- ▶ Ensure that the inside diameters of the gaskets are greater than or equal to that of the process connections and piping.
- ▶ Ensure that the seals are clean and undamaged.
- ▶ Secure the seals correctly.

##### Mounting the sensor with the threaded adapter in the pipe

- ▶ Mount the sensor in the pipe in full compliance with the mounting conditions →  20.

##### Welding the sensor with the welding socket into the pipe

1. Tack-weld the process connection to secure it in the pipe.
2. Release the screws on the process connections and remove the sensor, along with the seal, from the pipe.
3. Weld the process connection into the pipe.
4. Mount the sensor, along with the seals, back on the process connections. Ensure that all the connection parts are clean and the vent groove on the process connection is located on the underside of the transmitter.
5. Check whether the process connections and seals are centered when mounted.
6. Tighten the screws in a diagonally opposite sequence with a torque of 7 Nm (5.2 lbf ft).

### 6.2.2 Mounting the transmitter

#### CAUTION

##### Ambient temperature too high!

Danger of electronics overheating and housing deformation.

- ▶ Do not exceed the permitted maximum ambient temperature →  20.
- ▶ If operating outdoors: Avoid direct sunlight and exposure to weathering, particularly in warm climatic regions.

#### CAUTION

##### Excessive force can damage the housing!

- ▶ Avoid excessive mechanical stress.

### Transmitter with aluminum housing

- ▶ Mount the transmitter on the DIN rail DIN EN 60715 TH 35 using the DIN rail holder.

### Transmitter with stainless steel housing

The transmitter can be mounted in the following ways:

- Mounting with mounting plate
- Mounting with transmitter holder for post mounting (accessory)

#### Mounting with mounting plate

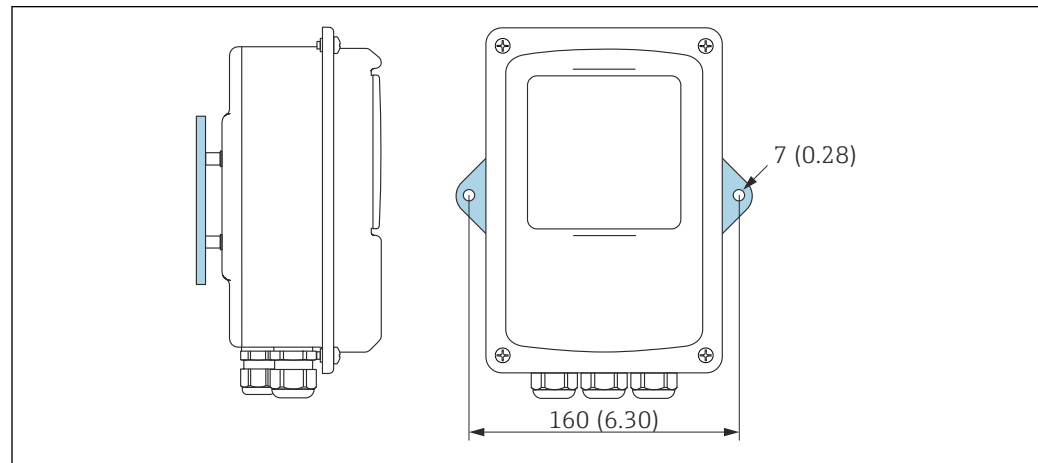

A0043201

9 Engineering unit mm (in)

- ▶ Secure the mounting plate according to the bores provided.

#### Mounting with transmitter holder for post mounting (accessory)

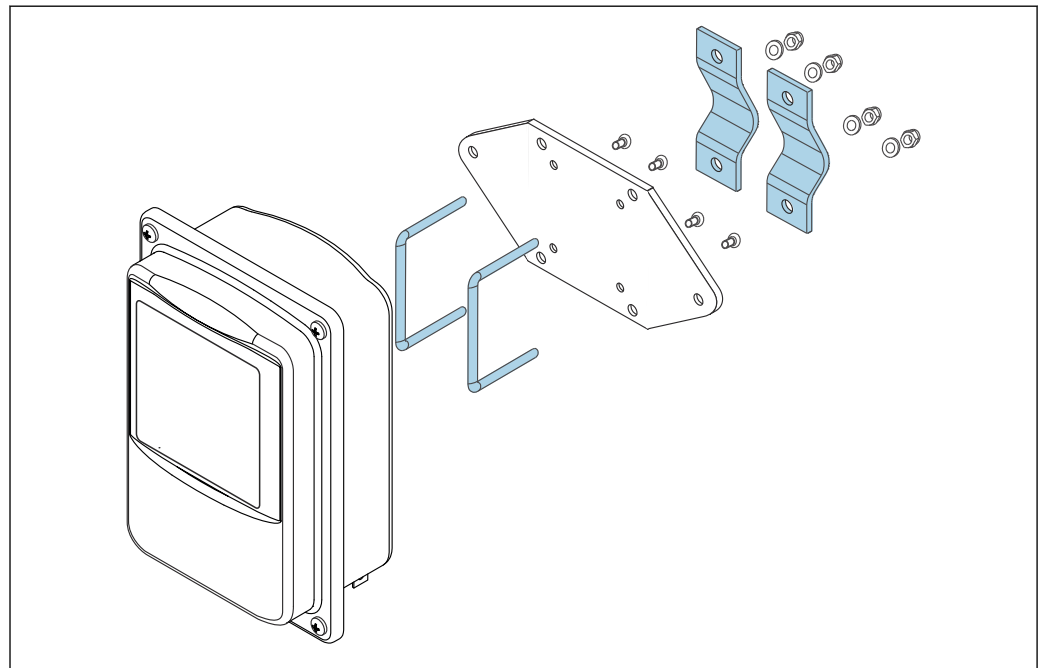

A0044706

1. Unscrew the mounting plate.
2. Guide the holder rods through the pre-drilled openings in the mounting plate and screw the mounting plate back onto the transmitter.

- Secure the transmitter holder to a post with the clamps.

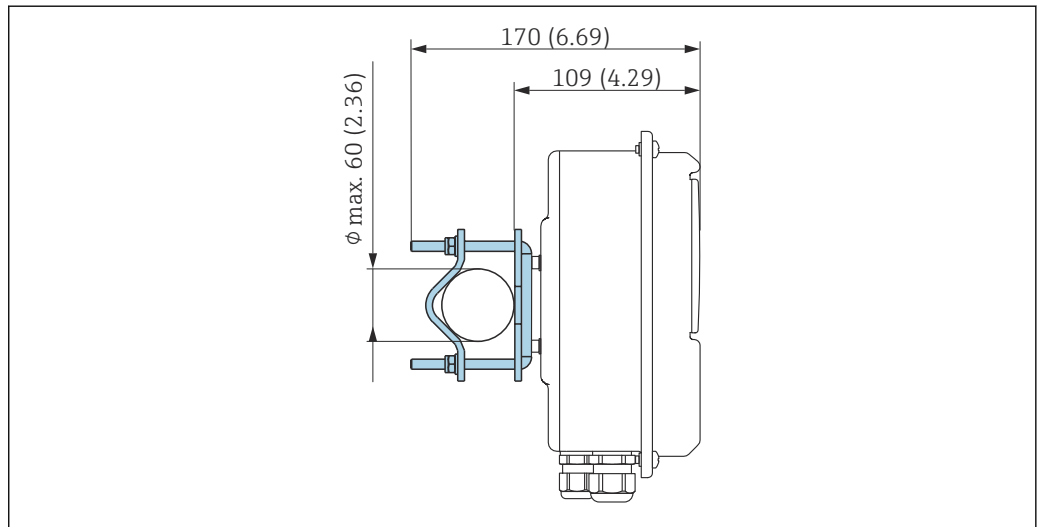

### 6.3 Post-installation check

Perform the following checks after the installation:

Device condition and specification	Note
Is the device damaged (visual inspection)?	<input type="checkbox"/>
Does the device meet the specifications, such as <ul style="list-style-type: none"> <li>▪ Ambient temperature</li> <li>▪ Nominal pressure</li> <li>▪ Measuring range → 80</li> </ul>	<input type="checkbox"/>
Installation	Note
Has the correct mounting location been selected? → 20	<input type="checkbox"/>
Process environment/process conditions	Note
Are the specifications for the inlet run observed? Inlet run $\geq 10 \times DN$	<input type="checkbox"/>
Are the specifications for the outlet run observed? Outlet run $\geq 5 \times DN$	<input type="checkbox"/>
Is the measuring device protected against precipitation and direct sunlight?	<input type="checkbox"/>

## 7 Electrical connection

**i** The measuring device does not have an internal circuit breaker. For this reason, assign the measuring device a switch or power-circuit breaker that allows the power supply line to be easily disconnected from the mains.

### 7.1 Connecting requirements

#### 7.1.1 Requirements for connecting cable

The connecting cables provided by the customer must fulfill the following requirements.

##### Electrical safety

In accordance with applicable national regulations.

##### Sensor/transmitter connecting cable

Only use the cable supplied.

##### Modbus Ethernet cable

Cable type	100 Base-TX
Cable category	Min. CAT5
Plug type	RJ-45 (8P8C)
Shielding	S/FTP, F/FTP, SF/FTP, S/UTP, F/UTP or SF/UTP
Cable length	Max. 30 m (98 ft)



##### Power supply and signal cables

Cable type	Strand or solid wire
Conductor cross-section	0.129 to 1.31 mm <sup>2</sup> (16 to 26 AWG)
Temperature range	<ul style="list-style-type: none"> <li>■ -40 to 70 °C (-40 to +158 °F) when mounted in a fixed position</li> <li>■ -10 to 50 °C (+14 to +122 °F) when cable can move freely</li> </ul>
Cable length	Max. 30 m (98 ft)
Power supply cable	Standard installation cable is sufficient.
Analog output	Standard installation cable is sufficient.
Digital input	Standard installation cable is sufficient.
Switch output (alarm)	Standard installation cable is sufficient.

#### 7.1.2 Terminal assignment

Terminal	Assignment	Description
V+	$V_{in}$ DC 24 V	Supply voltage
V-		
+	<b>out</b> 0 to 10 V; 4 to 20 mA	Analog output
-		
0	<b>output</b> selection	Digital input



Terminal	Assignment	Description
1		
		Digital input ground
	<b>alarm</b> Max. AC 30 V/DC 50 V, 1 A	Switch output
		

### 7.1.3 Requirements for the supply unit

Supply voltage	DC 24 V ±20%
Version	Touch-safe circuit according to DIN EN 61010-1, as terminal V- is electrically connected to the transmitter housing.
Power unit	The power unit must be tested to ensure it meets safety requirements (PELV), as the measuring device is Class III equipment.

## 7.2 Connecting the measuring device: transmitter with aluminum housing

### DANGER

#### Incorrect connection may result in injury or death

- ▶ Have electrical connection work carried out by appropriately trained specialists only.
- ▶ Observe applicable federal/national installation codes and regulations.
- ▶ Comply with local workplace safety regulations.

### 7.2.1 Connecting the connecting cable

Connect the sensor to the transmitter only using the connecting cable supplied.

#### NOTICE

#### Measuring device malfunction

Damaged cables can impact the functional integrity of the measuring device.

- ▶ Avoid strain when laying the connecting cable.
- ▶ Do not bend or shorten the connecting cable.
- ▶ Do not remove the plug of the connecting cable.
- ▶ Replace damaged or broken cables immediately.
- ▶ Route connecting cables separate from cables that carry very large electrical current (e.g. converter and motor connecting cables).

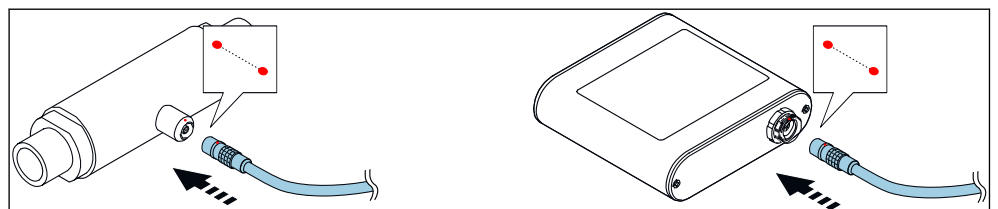

 10 Connecting the connecting cable

 Red dots on the connectors indicate the position.

- ▶ Insert the push-pull connectors of the connecting cable into the sockets at the position indicated until they engage with a click.

### Connecting the connecting cable with the order code for "Sensor options", option CM (IP69)

1. Insert the M12 plug of the connecting cable into the sensor socket at the position indicated and tighten.
2. Insert the push-pull connector of the connecting cable into the transmitter socket at the position indicated until it engages with a click.



### 7.2.2 Connecting the signal and supply voltage cables

**i** The measuring device does not have an internal circuit breaker. For this reason, assign the measuring device a switch or power-circuit breaker that allows the power supply line to be easily disconnected from the mains.

The signal can be transmitted using analog technology via the analog output and using digital technology via Ethernet (Modbus protocol). The connection to the "Teqwave Viewer" operating tool is also established via the Ethernet interface. For information on establishing the connection to the "Teqwave Viewer", see the →  34.

#### **⚠ DANGER**

#### **Serious or fatal injury from electric shock**

- ▶ Ground terminal V- and the sensor housing separately from one another because terminal V- is connected to the sensor housing.
1. Connect the protective conductor to terminal V-.
  2. Ground the transmitter housing. Make sure that terminal V- and the transmitter housing are grounded separately from one another.
  3. Connect the signal and supply voltage cables to the transmitter via screw terminals, terminal assignment →  24.
  4. For transmission via Modbus protocol or connection to the Teqwave Viewer, connect the Ethernet cable to the Ethernet port of the transmitter and the Ethernet port of the computer or network. For information on establishing the connection to the "Teqwave Viewer", see the →  34.

### 7.2.3 Ensuring potential equalization

The measuring device must be included in the potential equalization. The transmitter and sensor are connected to the same potential via the connecting cable. This potential must be current-free.

## 7.3 Connecting the measuring device: transmitter with stainless steel housing

#### **⚠ DANGER**

#### **Incorrect connection may result in injury or death**

- ▶ Have electrical connection work carried out by appropriately trained specialists only.
- ▶ Observe applicable federal/national installation codes and regulations.
- ▶ Comply with local workplace safety regulations.

### 7.3.1 Opening the housing cover

1. Loosen the 4 fixing screws on the housing cover.
2. Open the housing cover.

### 7.3.2 Connecting the connecting cable

Connect the sensor to the transmitter only using the connecting cable supplied.

#### NOTICE

#### Measuring device malfunction

Damaged cables can impact the functional integrity of the measuring device.

- ▶ Avoid strain when laying the connecting cable.
- ▶ Do not bend or shorten the connecting cable.
- ▶ Do not remove the plug of the connecting cable.
- ▶ Replace damaged or broken cables immediately.
- ▶ Route connecting cables separate from cables that carry very large electrical current (e.g. converter and motor connecting cables).

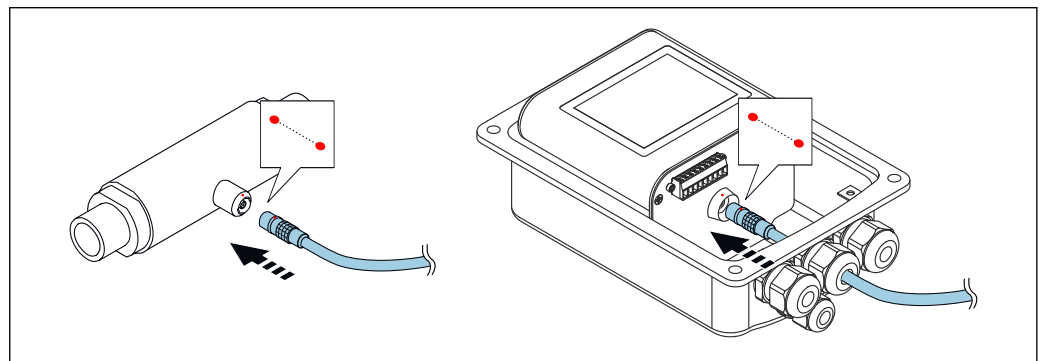

A0043295

**i** Red dots on the connectors indicate the position.

1. Push the connecting cable through the cable entry. To ensure tight sealing, do not remove the sealing ring from the cable entry.
2. Insert the push-pull connectors of the connecting cable into the sockets at the position indicated until they engage with a click. Red dots on the connectors indicate the position.
3. Firmly tighten the cable glands.

#### Connecting the connecting cable with the order code for "Sensor options", option CM (IP69)

1. Push the connecting cable through the cable entry. To ensure tight sealing, do not remove the sealing ring from the cable entry.
2. Insert the M12 plug of the connecting cable into the sensor socket at the position indicated and tighten.
3. Insert the push-pull connector of the connecting cable into the transmitter socket at the position indicated until it engages with a click.
4. Firmly tighten the cable glands.

### 7.3.3 Connecting the signal and supply voltage cables

**i** The measuring device does not have an internal circuit breaker. For this reason, assign the measuring device a switch or power-circuit breaker that allows the power supply line to be easily disconnected from the mains.

The signal can be transmitted using analog technology via the analog output and using digital technology via Ethernet (Modbus protocol). The connection to the "Teqwave Viewer" operating tool is also established via the Ethernet interface. For information on establishing the connection to the "Teqwave Viewer", see the → 34.

**⚠ DANGER****Serious or fatal injury from electric shock**

- ▶ Ground terminal V- and the sensor housing separately from one another because terminal V- is connected to the sensor housing.

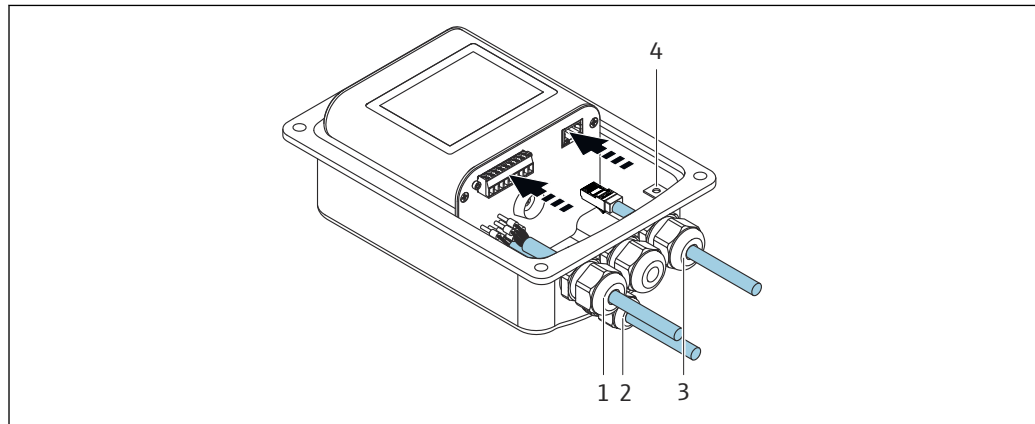

A0043296

1. Push the signal and supply voltage cables through cable entries (1) and (2) and (where applicable) push the Ethernet cable through the cable entry (3). To ensure tight sealing, do not remove the sealing ring from the cable entry.
2. Connect the protective conductor to terminal V-.
3. Ground the transmitter housing with ground terminal (4). Make sure that terminal V- and the transmitter housing are grounded separately from one another.
4. Connect the signal and supply voltage cables to the transmitter via screw terminals, terminal assignment → 24.
5. For transmission via Modbus protocol or connection to the Teqwave Viewer, connect the Ethernet cable to the Ethernet port of the transmitter and the Ethernet port of the computer or network. For information on establishing the connection to the "Teqwave Viewer", see the → 34.
6. Firmly tighten the cable glands.

**7.3.4 Ensuring potential equalization**

The measuring device must be included in the potential equalization. The transmitter and sensor are connected to the same potential via the connecting cable. This potential must be current-free.

**7.3.5 Closing the housing cover**

1. Close the housing cover.
2. Tighten the 4 fixing screws on the housing cover. Screw in the screws **without** using any lubricant (grease). If lubricant is used, the housing degree of protection can be compromised due to poor housing sealing.

## 7.4 Special connection instructions

### 7.4.1 Connection examples

#### Current output 4 to 20 mA

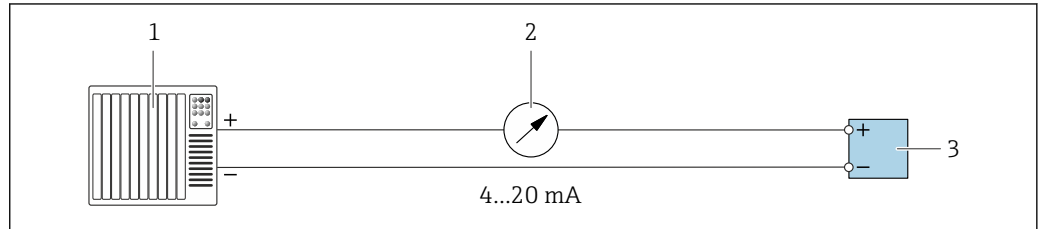

A0028758

11 Connection example for current output, active, 4 to 20 mA

- 1 Automation system with current input (e.g. PLC)
- 2 Analog display unit: maximum load 500 Ω
- 3 Transmitter

#### Voltage output 0 to 10 V

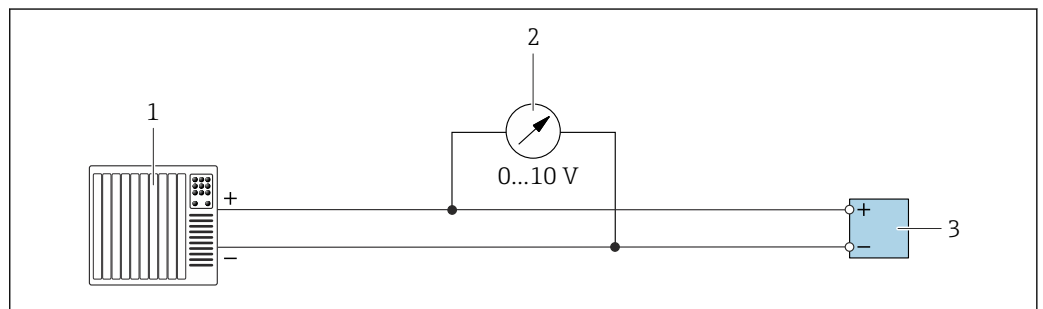

A0035460

12 Connection example for voltage output, active, 0 to 10 V

- 1 Automation system with current or voltage input (e.g. PLC)
- 2 Analog display unit for voltage: the load must be at least 750 Ω
- 3 Transmitter

#### Switch output

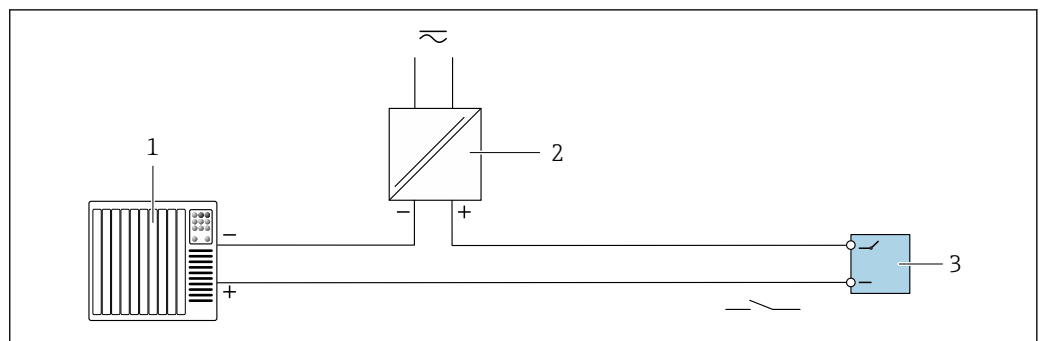

A0035461

13 Connection example for switch output, passive

- 1 Automation system with switch input (e.g. PLC)
- 2 Supply voltage: max. AC 30 V/DC 50 V
- 3 Transmitter

### Digital input (elective inputs)

The digital input can output up to four measured variables on the analog output.

Configuration options:

Active analog output	Digital input "0"	Digital input "1"
Channel 1	Open	Open
Channel 2	Ground	Open
Channel 3	Open	Ground
Channel 4	Ground	Ground

#### NOTICE

#### Interference at the digital input

If the measuring device is connected incorrectly, this can impact the functional integrity of the device.

- If the digital input is used, only connect digital inputs "0" and "1" to signal ground.

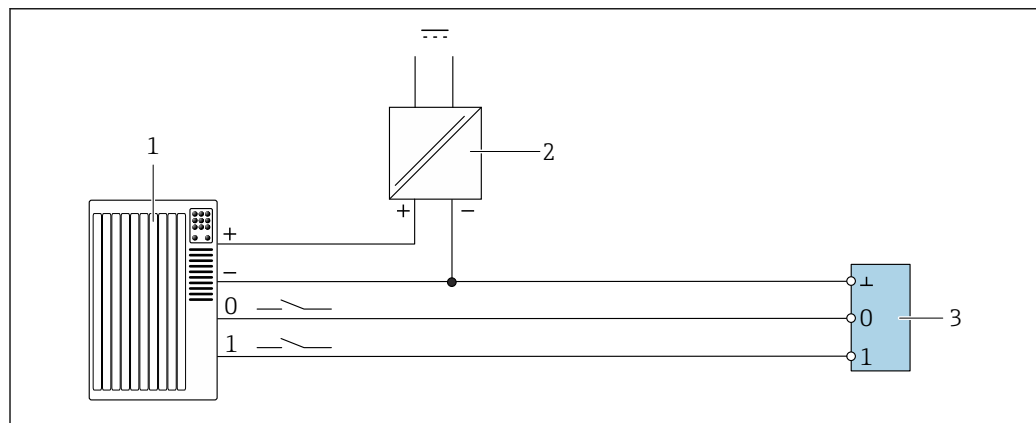

14 Connection example for the digital input

- 1 Automation system with switch input (e.g. PLC)
- 2 Power supply
- 3 Transmitter

**i** If the transmitter is connected as illustrated in the example, the outputs are no longer galvanically isolated.

## 7.5 Post-connection check

Are cables or the device undamaged (visual inspection)?	<input type="checkbox"/>
Do the cables used comply with the requirements ?	<input type="checkbox"/>
Do the mounted cables have adequate strain relief?	<input type="checkbox"/>
Are all the connectors firmly seated?	<input type="checkbox"/>
Is the terminal assignment correct?	<input type="checkbox"/>
Are terminal V- and the transmitter housing grounded separately from one another?	<input type="checkbox"/>
Are all of the screw terminals well-tightened?	<input type="checkbox"/>
Are all the cable glands installed, tightened and sealed?	<input type="checkbox"/>
If the supply voltage is applied, is the device ready for operation and does anything appear on the display module (transmitter with a touch screen) or is the power LED on the measuring device lit (transmitter with LED status indication)?	<input type="checkbox"/>

## 8 Operation options

### 8.1 Overview of the operation options

The measuring device can be operated in the following ways:

- Operation via the local display (transmitter with touch screen)
- Operation via the "Teqwave Viewer" operating tool supplied

### 8.2 Access to the measuring device via the local display

If you are using the transmitter with a touch screen, it is possible to access the measuring device via the transmitter touch screen and via the "Teqwave Viewer" operating tool.

**i** If the transmitter is located in the stainless steel housing, the housing must be opened and the housing cover removed to gain access to the touch screen.

Functions supported by the transmitter with a touch screen:

- Display and graphic visualization of measured variables
- Selection of a concentration app or recipe
- Device configurations

#### 8.2.1 Operational display of the transmitter with a touch screen

The operational display is used to display the measured values and the sensor status. In addition, users can access the Settings menu from this display. Select a measured variable to switch to the graph display format.

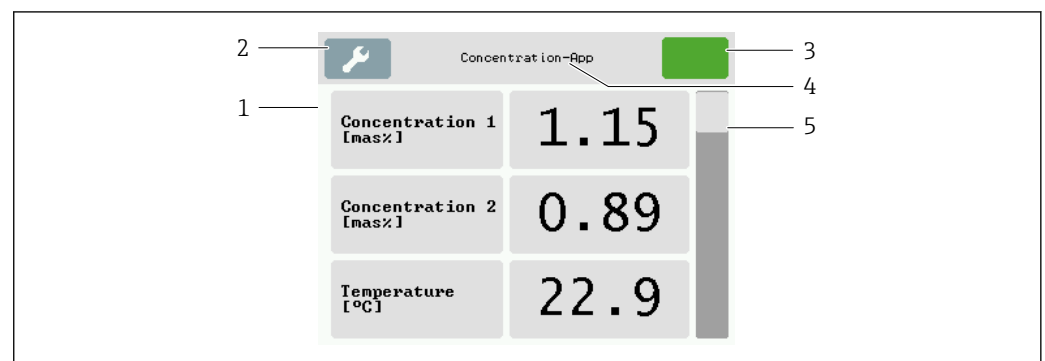

**15** Operational display

- 1 Measured value display
- 2 Settings menu
- 3 Status indicator
- 4 Name of the concentration app or recipe
- 5 Scroll bar

#### NOTICE

#### Double measured value display of alcohol concentration in the "Distillery; sugar, invert sugar, alcohol" application package

Concentration apps where the physical density can be compensated display the alcohol concentration twice.





- ▶ For more information see the channel description in the data sheet of the concentration app.

#### Measured value display

Each line shows an active measured variable, its name and the physical unit and measured value. Users can choose from a total of three different display modes, in which three, five

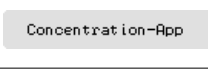
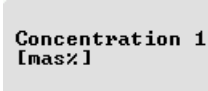
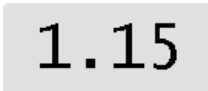

or seven measured values can be displayed. If there are several measured values, users must scroll down using the scroll bar on the right to be able to see all the measured variables.

### Functions of the display and operating elements

Button	Description
	<b>Settings menu</b> Opens the settings.
	<b>Navigation</b> Navigate between the menus or submenus.
	<b>Status indicator</b> Displays the current status, and navigation to more detailed status messages in text format.
	<b>Concentration app name or operational display button</b> Displays the name of the concentration app, and navigation to the operational display.
	<b>Measured variable display</b> Displays the measured variable and its unit, and navigation to the Graph View.
	<b>Measured value display</b> Displays the measured value, and navigation to the Graph View.
	<b>Scroll bar</b> For scrolling up and down.

### States of functions and parameters

Tap a parameter or function to open the related submenu or to activate a function.

Button	Description
	<b>Blue background</b> Parameter is selected or function is activated.
	<b>Gray background</b> Parameter is not selected or function is deactivated.



**Editing elements**

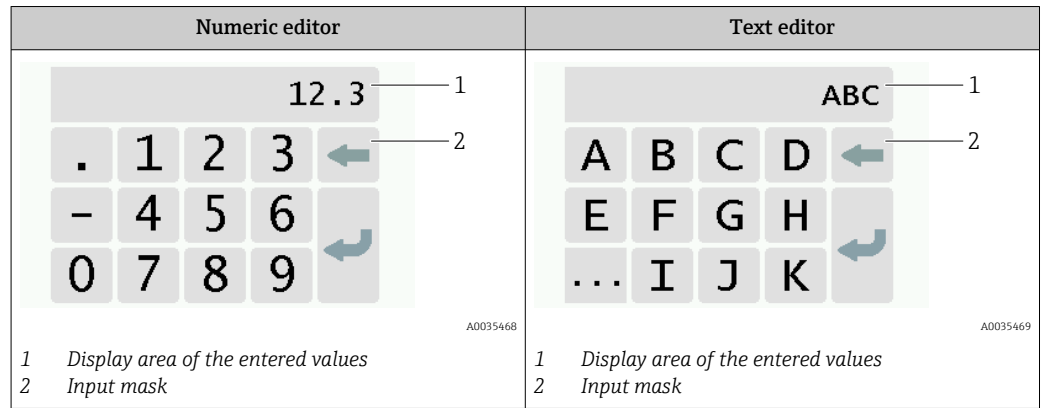

**Input mask**

The following input and operating symbols are available in the input mask of the numeric and text editor:

*Input and operating symbols in the editors*

Symbol	Meaning
	Selection of letters from A to Z.
	Selection of numbers from 0 to 9 and special characters.
	Inserts decimal separator at the cursor position.
	Inserts minus sign at the cursor position.
	Confirms selection.
	Clears the last character entered.

**8.2.2 LED status indication (transmitter with LED status indication)**

For a description, see "Diagnostics information for transmitter with LED status indication" → 69.

**8.3 Access to the measuring device via the operating tool**

The transmitter with LED status indication can only be configured using the "Tegwave Viewer" operating tool. If the transmitter with a touch screen is used, the transmitter can

be operated both via the touch screen and via the Viewer tool. The range of functions of the "Teqwave Viewer" operating tool varies depending on the software package installed.

*Supported functions:*

Included in the standard scope of supply: Teqwave Viewer V2.3 – basic package	Order code for "Application package" option EP: Teqwave Viewer V2.3 – Viewer with interface for data download
<ul style="list-style-type: none"> <li>▪ Live display and graphic visualization of measured variables</li> <li>▪ Save graph</li> <li>▪ Manage concentration apps and recipes on the transmitter</li> <li>▪ Device configurations</li> <li>▪ Switch between multiple transmitters</li> <li>▪ Self-test</li> </ul>	<ul style="list-style-type: none"> <li>▪ Live display and graphic visualization of measured variables</li> <li>▪ Save graph</li> <li>▪ Manage concentration apps and recipes on the transmitter</li> <li>▪ Device configurations</li> <li>▪ Switch between multiple transmitters</li> <li>▪ Self-test</li> <li>▪ Read saved measured values</li> <li>▪ Offline analysis with graphic visualization of the measured values</li> <li>▪ Measured data logging and export function</li> </ul>

### 8.3.1 System requirements

#### Computer hardware

<b>Interface</b>	The computer must have an Ethernet RJ45 interface.
<b>Connection</b>	Standard Ethernet cable with RJ45 connector.
<b>Screen</b>	Recommended screen resolution: min. 1024 x 768 pixel.

#### Computer software

<b>Recommended operating system</b>	Microsoft Windows 7 or higher.
-------------------------------------	--------------------------------

#### Computer settings

<b>User rights</b>	Appropriate user rights (e.g. administrator rights) for TCP/IP and proxy server settings are necessary (for changing the IP address or subnet mask).
<b>Network connections</b>	Only use active network connections to the measuring device. Switch off all other network connections such as WLAN.

### 8.3.2 Software installation

#### Installing the "Teqwave Viewer" operating tool

1. Close all applications.
2. Insert the DVD supplied into the drive.
3. Double-click the "setup.exe" file to start the installation.
4. Follow the instructions in the installation window.

### 8.3.3 Establishing a connection for the transmitter - Viewer Internet protocol

#### Configuring the Internet protocol of the computer

1. Switch on the measuring device.

2. Connect it to the computer using the Ethernet cable.
  3. If a second network card is not used: close all the applications on the computer that need the Internet or a network (e.g. e-mail, SAP, Internet Explorer).
  4. Configure the properties of the Internet protocol (TCP/IP) as defined in the network settings of the transmitter with a static IP address in the same address range.  
Example: transmitter IP address: 192.168.1.212 → PC IP address: 192.168.1.2
-  For transmitters with LED status indication: the transmitter IP address is located on the nameplate. The subnet mask default setting is 255.0.0.0. It is possible to change the network settings as soon as a connection to the Viewer has been established.

### Viewing and configuring the network settings

#### Navigation using transmitter with touch screen

1. Settings menu → "Network settings" → "Network status"
2. Settings menu → "Network settings" → "System name"
3. Settings menu → "Network settings" → "MAC address"
4. Settings menu → "Network settings" → "IP address"
5. Settings menu → "Network settings" → "Subnet mask"
6. Settings menu → "Network settings" → "Gateway"
7. Settings menu → "Network settings" → "DHCP"



#### Navigation using the Viewer

1. Menu "Teqwave Transmitter" → "Network settings" → "IP address"
2. Menu "Teqwave Transmitter" → "Network settings" → "NetBIOS name"
3. Menu "Help" → "Version" → "MAC address"
4. Menu "Teqwave Transmitter" → "Network settings" → "Subnet mask"
5. Menu "Teqwave Transmitter" → "Network settings" → "Gateway"
6. Menu "Teqwave Transmitter" → "Network settings" → "Switch DHCP status"

 The operating tool sends the settings to the transmitter once the "Send (parameters)" button is clicked.

#### Parameter overview with brief description

Parameter	Description	Selection/entry/display	Factory setting
Network status <sup>1)</sup>	Displays the current connection status.	<ul style="list-style-type: none"> <li>■ Static IP address</li> <li>■ DHCP</li> <li>■ Not connected</li> </ul>	-
System name <sup>2)</sup> NetBIOS name <sup>3)</sup>	Enter the name or NetBIOS name of the transmitter where it can be reached in the network.	Sequence of letters and characters, no special characters, max. 15 characters.	[Serial number]
MAC address	Displays the physical network address of the device.	Byte-wise notation, colon-separated	Depends on the transmitter

Parameter	Description	Selection/entry/display	Factory setting
IP address	<p>Enter the IPv4 address.</p> <p> <ul style="list-style-type: none"> <li>The transmitter IP address assigned at the factory is indicated on the transmitter nameplate.</li> <li>The network settings of the computer must be configured with a static IP address in the same address range.</li> </ul> </p>	<p>Group of four: 0 to 255 (in the specific group)</p> <p> 0.0.0.0, 127.0.0.1 and 255.255.255.255 are not allowed.</p>	192.168.1.212
Subnet mask	<p>Enter one of the predefined values, or a new value, for the subnet mask.</p>	<ul style="list-style-type: none"> <li>255.255.255.0</li> <li>255.255.0.0</li> <li>255.0.0.0</li> <li>Group of four: 0 to 255 (in the specific group)</li> </ul>	255.255.255.0
Gateway	<p>Enter the IP address for a gateway in the local network.</p>	<p>Group of four: 0 to 255 (in the specific group)</p>	0.0.0.0
DHCP <sup>2)</sup> Change DHCP status <sup>3)</sup>	<p>Enable DHCP to allow the DHCP server in the network to automatically assign the IP address for the transmitter.</p> <p> The function is only available if the transmitter has a "system name" (also known as the "NetBIOS name"). Otherwise, the Viewer cannot find the transmitter in the network. The system name is preconfigured when the device is delivered.</p>	<p>Enable or disable the function</p>	The function is disabled

- 1) Only displayed via the transmitter
- 2) Name displayed on the local display (transmitter)
- 3) Name displayed on the Viewer

*Establishing a connection with the transmitter*

1. Start the "Teqwave Viewer" operating tool.
2. Under "Teqwave Transmitter" → "Change transmitter": enter the IP address or system name (Net-BIOS name) of the transmitter.
  - ↳ The measured values are displayed on the right of the graph and on the graphic display.

**8.3.4 User interface**

Different functions are enabled or disabled in the menus depending on the license purchased (Teqwave Viewer (basic package) or Teqwave Viewer (with interface for data download)). Disabled functions are grayed out and cannot be selected. The central element on the start screen is a graph that displays the selected measured variables over the time

period. To the right of the graph, the user interface also shows all the measured variables, the sensor status and the IP address of the transmitter.

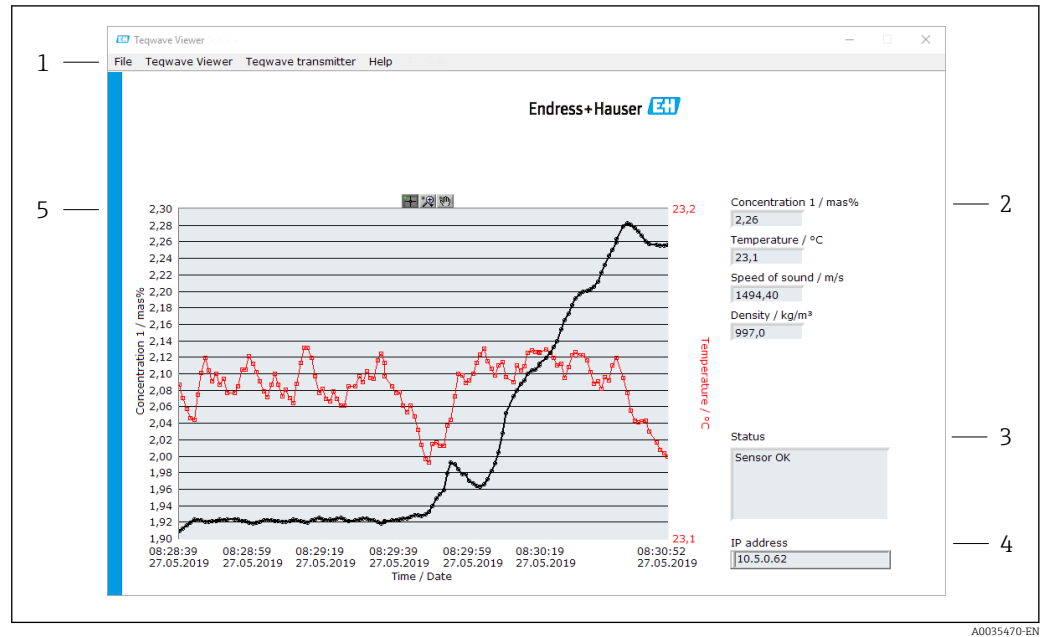

A0035470-EN

16 User interface

- 1 Menu bar
- 2 Measured variable display (with scroll bar if more than six measured variables)
- 3 Status indicator
- 4 IP address displayed
- 5 Graph

**NOTICE**

**Double measured value display of alcohol concentration in the "Distillery; sugar, invert sugar, alcohol" application package**



Concentration apps where the physical density can be compensated display the alcohol concentration twice.

- ▶ For more information see the channel description in the data sheet of the concentration app.

**Menu bar**

Menu	Description
File	Functions to start and stop measured value transmission and to save the graph.
Teqwave Viewer	Functions that are required to configure the operating tool.
Teqwave Transmitter	Functions that are required to configure the transmitter and function for accessing another transmitter.
Help	Information about the system and Operating Instructions.

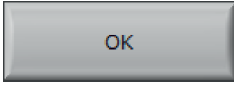
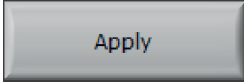
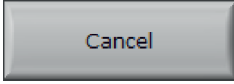
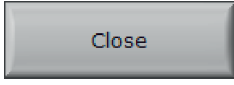
### 8.3.5 General control and operating elements

Button	Description
 <p style="text-align: right; font-size: small;">A0035492-EN</p>	<p><b>OK</b> button Confirm or exit the function.</p>
 <p style="text-align: right; font-size: small;">A0035493-EN</p>	<p><b>Apply</b> button Accept entries or send entries to transmitter.</p>
 <p style="text-align: right; font-size: small;">A0035494-EN</p>	<p><b>Cancel</b> button Cancel the operation.</p>
 <p style="text-align: right; font-size: small;">A0035495-EN</p>	<p><b>Close</b> button Exit the function.</p>
 <p style="text-align: right; font-size: small;">A0035496</p>	<p><b>Active</b> button Enable function or parameter. A bright-green arrow indicates enabled functions and parameters.</p>
 <p style="text-align: right; font-size: small;">A0035497</p>	<p><b>Inactive</b> button Disable function or parameter. A dark-green arrow indicates disabled functions and parameters.</p>

## 9 System integration

### 9.1 Overview of device description files

Current version data for the device

<b>Firmware version</b>	2.3.zz	<ul style="list-style-type: none"> <li>▪ On the title page of the Operating Instructions</li> <li>▪ On the nameplate</li> <li>▪ On the local display: settings</li> <li>▪ Via the "Teqwave Viewer" operating tool: Help → Version</li> </ul>
<b>Release date of firmware version</b>	02.2021	
<b>License key</b>		<ul style="list-style-type: none"> <li>▪ If additional functions are subsequently added: in the service e-mail and on the CD-ROM</li> <li>▪ Read via the "Teqwave Viewer" operating tool: Help → Version.</li> </ul>

 For an overview of the different firmware versions for the device →  74.

### 9.2 Modbus TCP information

#### 9.2.1 General settings for the Modbus interface

<b>Data access</b>	Modbus TCP (port 502)
<b>Protocol</b>	Modbus Applications Protocol Specification V1.1

#### 9.2.2 Function codes

The function code determines which read or write actions the Modbus protocol performs.

The measuring device supports the following function codes:

Code	Name	Description	Application
0x04	Read Input Registers	Master reads one or more Modbus registers from the device.	Read process variables with read access Example: read concentration A
0x10	Write Multiple Registers	Master writes a new value to one or more Modbus registers of the device (requires start address and number).	Write process variables Example: write density

#### 9.2.3 Register information

Register name	Access	Data type	Register address	Length	Input/output
Concentration A	Read	IEEE754 32 bit	0x0000:0x0001	2	Floating point number in IEEE754 format (big endian)
Concentration B	Read	IEEE754 32 bit	0x0002:0x0003	2	
Concentration C	Read	IEEE754 32 bit	0x0004:0x0005	2	

Register name	Access	Data type	Register address	Length	Input/output
Additional analysis parameter 1	Read	IEEE754 32 bit	0x0006:0x0007	2	
Additional analysis parameter 2	Read	IEEE754 32 bit	0x0008:0x0009	2	
Additional analysis parameter 3	Read	IEEE754 32 bit	0x000A:0x000B	2	
Additional analysis parameter 4	Read	IEEE754 32 bit	0x000C:0x000D	2	
Additional analysis parameter 5	Read	IEEE754 32 bit	0x000E:0x000F	2	
Temperature / K	Read	IEEE754 32 bit	0x0010:0x0011	2	
Speed of sound / m/s	Read	IEEE754 32 bit	0x012:0x0013X	2	
Density / kg/m <sup>3</sup>	Read	IEEE754 32 bit	0x0014:0x0015	2	
Dispersion	Read	IEEE754 32 bit	0x001A:0x001B	2	
System status	Read	32 bit unsigned	0x0050:0x0051	2	Diagnostic information
 To increase measuring accuracy, predefined compensation values can be used for the compensation of the speed of sound and acoustic density specifically for your application. The compensation values can be read into the device from external measuring devices via Modbus TCP or entered as constant measured values (Configuration of compensation value 1...4). The compensation values are only available if they were provided in the data record of the concentration app upon delivery.					
Compensation value 1	Read / write	IEEE754 32 bit	0x1852:0x1853	2	Floating point number in IEEE754 format (big endian)
Compensation value 2	Read / write	IEEE754 32 bit	0x1854:0x1855	2	
Compensation value 3	Read / write	IEEE754 32 bit	0x1856:0x1857	2	
Compensation value 4	Read / write	IEEE754 32 bit	0x1858:0x1859	2	
Configuration of compensation value 1	Read / write	16 bit unsigned	0x1D6B	1	<ul style="list-style-type: none"> <li>■ 0 = disabled: measured variable is not taken into consideration.</li> <li>■ 1 = fixed value: entered measured value is taken into consideration.</li> <li>■ 2 = Modbus: the measured value received via Modbus TCP is taken into consideration.</li> </ul>
Configuration of compensation value 2	Read / write	16 bit unsigned	0x1D86	1	
Configuration of compensation value 3	Read / write	16 bit unsigned	0x1DA1	1	
Configuration of compensation value 4	Read / write	16 bit unsigned	0x1DBC	1	

 While values are transmitted in "big endian" format during Modbus communication, in line with specifications, the sequence of the bytes received may have to be reversed, depending on the system used, to convert between big endian and little endian format.

#### Example: read concentration A

The result is a floating point number in the format IEEE754 32 bit. The value is saved in two consecutive addresses, with the first address containing the least significant word (sign, exponent and upper part of the mantissa) and the second address containing the most significant word (lower part of the mantissa).



To get the concentration, the following data must be sent for a query to the transmitter IP address via port 502:

Send to transmitter: 04 0000 0002		Reply from transmitter: 04 04 41CE 7FF3	
04:	Function: Read Input Registers (0x04)	04:	Function: Read Input Registers (0x04)
0000:	Start address: 0x0000	04:	Number of consecutive bytes: 0x04
0002:	Number of registers to be read (16-bit): 0x0002	41CE 7FF3:	Floating point number in IEEE754 format (big endian format)

Process both registers separately for conversion to little endian format:

- Word 1, register address 0x0000, least significant word: 0x41CE
- Word 2, register address 0x0001, most significant word: 0x7FF3

Conversion from big endian to little endian format of both registers:

- Word 1, register address 0x0000, least significant word: 0xCE41
- Word 2, register address 0x0001, most significant word: 0xF37F

Swap the content of the two register addresses:

The result is 0xF37F CE41, which corresponds to a decimal value of 25.812475.

## 10 Commissioning

### NOTICE

#### Damage to the touch screen



Sharp objects, electrostatic discharge, water and the use of pens not designed for touch screens, such as standard pencils, can cause a malfunction of the transmitter or damage the touch screen.

- ▶ Do not use sharp objects to operate the touch screen.
- ▶ To avoid electrostatic discharge, make sure the touch screen does not come into contact with other devices.
- ▶ Make sure the touch screen does not come into contact with water.
- ▶ Only use your finger or a specially designed stylus pen to operate the touch screen.

**i** If the transmitter is located in the stainless steel housing, to commission via the local display the housing must be opened and the housing cover removed in order to gain access to the touch screen.

### 10.1 Function check

Before commissioning the measuring device:

- ▶ Make sure that the post-installation and post-connection checks have been performed.
  - "Post-installation check" checklist →  23
  - "Post-connection check" checklist →  30

### 10.2 Switching on the measuring device

After a successful function check, switch on the measuring device.

After a successful startup, the local display switches automatically from the start screen to the measured value display.

**i** If nothing appears on the local display or an error message is displayed, perform diagnostics and troubleshooting →  68.

### 10.3 Setting the operating language

In the case of transmitters with a touch screen, the operating language is configured via the local display.

**i** If the transmitter is located in the stainless steel housing, to set the operating language the housing must be opened and the housing cover removed in order to gain access to the touch screen.

**i** The language is selected for the Viewer via "Teqwave Viewer" → "Language settings". The same range of options are available.

*Navigation using transmitter with touch screen*

Settings menu → "Language settings"

**i** Once the language has been selected, the operating tool transmits the language setting to the transmitter where it is saved.

Parameters	Procedure	Selection/input	Factory setting
Language setting	Tap to select the language	<ul style="list-style-type: none"> <li>▪ German</li> <li>▪ English</li> <li>▪ French</li> <li>▪ Spanish</li> <li>▪ Italian</li> </ul>	English

## 10.4 Configuring the measuring device

If you are using the transmitter with a touch screen, it is possible to configure the device either via the transmitter touch screen or via the "Teqwave Viewer" operating tool. If you are using the transmitter with an LED status indication, the configuration must be performed via the Viewer.

 If using areas of application: for information on the concentration apps contained in the areas of application and the associated measuring ranges, see the "Technical Information" document, "Measuring ranges" section.

### 10.4.1 Selecting the concentration app

A concentration app is enabled via the menu **Select concentration app** (transmitter with touch screen) or **Manage concentration app** (Viewer).

Navigation using transmitter with touch screen

Settings menu → "Select concentration app"

Navigation using the Viewer

Menu "Teqwave Transmitter" → "Manage concentration app"

*Parameter overview with brief description*

Parameter/function	Procedure	Selection/input	Factory setting
Select concentration app (transmitter) Manage concentration apps (Viewer)	<b>Transmitter</b> Tap the desired concentration app to select it. If the selected concentration app is inactive, tap the <b>Activate application</b> button to activate the concentration app. <b>Viewer</b> Select the desired concentration app from the "Concentration apps" drop-down menu. If the selected concentration app is inactive, tap the <b>Activate</b> button to activate the app.	Concentration app 1...n	Concentration app 1

### 10.4.2 Configuring the measuring unit

All the measured values are configured via the **Measuring unit** menu (transmitter with touch screen) or via the **View settings** menu (Viewer).

 **The measured value is automatically converted if the unit is changed.**  
**The unit for the speed of sound is m/s and cannot be changed.**

Navigation using transmitter with touch screen

- Settings menu → "Application parameter" → "Measuring unit" → "Analysis parameter 1...n"
- Settings menu → "Application parameter" → "Measuring unit" → "Temperature"
- Settings menu → "Application parameter" → "Measuring unit" → "Density"

Navigation using the Viewer

- Menu "Teqwave Transmitter" → "Display settings" → "Analysis parameter 1-n"
- Menu "Teqwave Transmitter" → "View settings" → "Temperature"
- Menu "Teqwave Transmitter" → "View settings" → "Density"

 The operating tool communicates the settings to the transmitter as soon as the **Apply** button is clicked.

*Parameter overview with brief description*

Parameter	Procedure	Selection/input	Factory setting
Analysis parameter 1-n	Select the unit for analysis parameter.	Depends on the selected concentration app	Depends on the selected concentration app
Temperature	Select the unit for temperature.	<ul style="list-style-type: none"> <li>▪ °C</li> <li>▪ °F</li> <li>▪ K</li> </ul>	°C
Density	Select the unit for density.	<ul style="list-style-type: none"> <li>▪ g/cm<sup>3</sup></li> <li>▪ kg/m<sup>3</sup></li> <li>▪ g/l</li> </ul>	kg/m <sup>3</sup>

### 10.4.3 Configuring the analog output

The **Application parameters** menu contains the parameters for the configuration of the analog output.

Navigation using transmitter with touch screen





1. Settings menu → "Application parameters" → "Analog output" → "Analog channel 1...4"
2. Settings menu → "Application parameters" → "Analog output" → "Current/Voltage"
3. Settings menu → "Application parameters" → "Analog output" → "Output settings"
4. Settings menu → "Application parameters" → "Analog output" → "Output settings" → "Suspend time (s)"
5. Settings menu → "Application parameters" → "Analog output" → "Test signal"

Navigation using the Viewer

1. Menu "Teqwave Transmitter" → "Application parameters" → "Analog channel 1...4"
2. Menu "Teqwave Transmitter" → "Application parameters" → "Current/Voltage"
3. Menu "Teqwave Transmitter" → "Application parameters" → "Output settings"
4. Menu "Teqwave Transmitter" → "Application parameters" → "Suspend time"
5. Menu "Teqwave Transmitter" → "Application parameters" → "Test signal"

 The operating tool communicates the settings to the transmitter as soon as the **Apply** button is clicked.

Parameter overview with brief description

Parameters	Procedure	Selection/input	Factory setting
Analog channel 1...4	<p>Select the measured variable or special function to be output at the analog output.</p> <p> If <b>Deactivate analog output</b> is selected, the analog interface is set to 0 V or 2 mA. The presentation on the display continues to run normally.</p> <p>▪ If <b>Suspend measurement</b> is selected, the measuring device stops and all the measured values and the system status freeze. If necessary, the <b>Suspend time</b> function can be used to specify a delay for switching the function on and off.</p>	<ul style="list-style-type: none"> <li>▪ Analysis parameter 1...n</li> <li>▪ Temperature</li> <li>▪ Speed of sound</li> <li>▪ Density</li> <li>▪ Dispersion</li> <li>▪ Deactivate analog output</li> <li>▪ Suspend measurement</li> </ul>	Analysis parameter 1
Current/Voltage	Select the type of signal of the analog interface.	<ul style="list-style-type: none"> <li>▪ Current (4 to 20 mA)</li> <li>▪ Voltage (0 to 10 V)</li> </ul>	Current (4 to 20 mA)
Output settings	<p>Behavior of the interface if the measuring range is breached (value over-range/under-range).</p> <p> If <b>0V/2mA exceeding limits</b> is selected, a failure value is displayed.</p> <p>▪ If <b>Min/Max exceeding limits</b> is selected, the value output is limited to the specified limit value →  46.</p>	<ul style="list-style-type: none"> <li>▪ 0V/2mA exceeding limits</li> <li>▪ Min/Max exceeding limits</li> </ul>	0 V/2 mA exceeding limits
Suspend time (s)	<p>Enter the suspend time in seconds until the measured values are recorded if the <b>Suspend measurement</b> function is active.</p> <p> If a <b>suspend time (s)</b> is entered and the <b>Suspend measurement</b> function is selected simultaneously in the <b>Analog channel 1...4</b> parameter and activation is via the digital input, the <b>Suspend measurement</b> function is delayed by the configured time.</p>	Positive integer 0 to 10000 s	0 s
Test signal	<p><b>Transmitter</b> Enter the current or voltage value for simulation. Output the test signal with <b>Activate / Deactivate</b></p> <p><b>Viewer</b> A new window appears as soon as the <b>Test signal</b> button is pressed. Enter the current or voltage value for simulation. Output the test signal with the <b>Test signal</b> button.</p> <p> The <b>Test signal</b> function allows users to simulate different process variables and the device alarm behavior without a real-life measuring situation.</p>	Floating point number with sign	0.0

### 10.4.4 Displaying calibration ranges

The calibration ranges for the temperature and the concentration and compensation values can be viewed via the **Select concentration app** menu (transmitter with touch screen). The calibration ranges are also specified on the data sheet of a concentration app.

Navigation using transmitter with touch screen

- ▶ Settings menu → "Select concentration app" → "Calibration range" → Select temperature, concentration or compensation value

### 10.4.5 Configuring the measuring range

The **Measuring range** menu contains parameters for configuring the measuring range.

-  The settings made in this menu also apply for the functions of the analog output, where they define the minimum (0 V/4 mA) and the maximum (10 V/20 mA).
- A valid measuring range must be configured for the selected concentration app in order to ensure correct operation. In addition, the calibration range is also specified for measured variables that are relevant for the calibration of the concentration app (temperature and concentration). The measuring device takes this calibration range from the concentration app file. It cannot be modified.

Navigation using transmitter with touch screen



1. Settings menu → "Application parameters" → "Measuring range" → "Select measured variable" → "Measuring range Max"
2. Settings menu → "Application parameters" → "Measuring range" → "Select measured variable" → "Measuring range Min"
3. Settings menu → "Application parameters" → "Measuring range" → Select measured variable → "Decimal places"

Navigation using the Viewer

1. Menu "Teqwave Transmitter" → "Measuring range" → "Select measured variable" → "Measuring range Max"
2. Menu "Teqwave Transmitter" → "Measuring range" → "Select measured variable" → "Measuring range Min"
3. Menu "Teqwave Transmitter" → "View settings" → "Select measured variable" → "Decimal places"

-  The operating tool communicates the settings to the transmitter as soon as the **Apply** button is clicked.

### Parameter overview with brief description

Parameter	Procedure	Selection/input	Factory setting
Measuring range Max	Enter the upper limit for the selected measured variable or 20 mA current/10 V voltage, while paying attention to the measuring range limits →  80 and concentration app data sheet.	Positive decimal	<ul style="list-style-type: none"> <li>▪ Analysis parameter 1...n: depends on the selected concentration app</li> <li>▪ Temperature: 120.0</li> <li>▪ Speed of sound: 2000.00</li> <li>▪ Density: 1500.00</li> </ul>
Measuring range Min	Enter the lower limit for the selected measured variable or 4 mA current/0 V V voltage, while paying attention to the measuring range limits →  80 and concentration app data sheet.	Positive decimal	<ul style="list-style-type: none"> <li>▪ Analysis parameter 1...n: depends on the selected concentration app</li> <li>▪ Temperature: 0.0</li> <li>▪ Speed of sound: 600.00</li> <li>▪ Density: 700.00</li> </ul>
Decimal places	Select the number of decimal places for the value of the measuring range.	<ul style="list-style-type: none"> <li>▪ 0</li> <li>▪ 1</li> <li>▪ 1 ±0.5</li> <li>▪ 2</li> <li>▪ 2 ±0.5</li> <li>▪ 3</li> <li>▪ 3 ±0.5</li> <li>▪ 4</li> </ul>	<ul style="list-style-type: none"> <li>▪ Analysis parameter 1...n: 2</li> <li>▪ Temperature: 1</li> <li>▪ Speed of sound: 2</li> <li>▪ Density: 1 ±0.5</li> </ul>

## 10.4.6 Configuring the switch output

The **Relay output** menu contains all the parameters for configuring the relay output.

Navigation using transmitter with touch screen







1. Settings menu → "Application parameters" → "Relay output" → "Settings" → "Select measured value" → "Output mode"
2. Settings menu → "Application parameters" → "Relay output" → "Settings" → "Select measured value" → "Switch point Max"/"Switch point Min" or "Switch point"
3. Settings menu → "Application parameters" → "Relay output" → "Settings" → "Hysteresis"
4. Settings menu → "Application parameters" → "Relay output" → "Settings" → "NC contact/NO contact"
5. Settings menu → "Application parameters" → "Relay output" → "Output"

Navigation using the Viewer

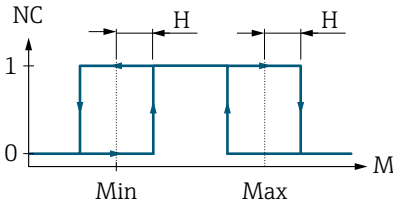
1. Menu "Teqwave Transmitter" → "Relay output" → "Select measured variable" → "Output mode"
2. Menu "Teqwave Transmitter" → "Relay output" → "Select measured variable" → "Switch point Max"/"Switch point Min" or "Switch point"
3. Menu "Teqwave Transmitter" → "Relay output" → "Select measured variable" → "Hysteresis"
4. Menu "Teqwave Transmitter" → "Relay output" → "Select measured variable" → "NC contact/NO contact"
5. Menu "Teqwave Transmitter" → "Relay output" → "Output"

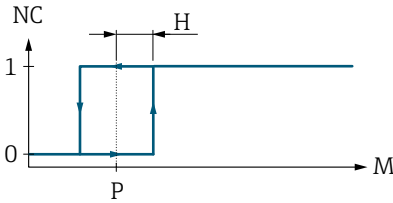
 The operating tool communicates the settings to the transmitter as soon as the **Apply** button is clicked.

Parameter overview with brief description

Parameter	Procedure	Selection/input	Factory setting
Output mode	<p>Select the mode for the switch point definition.</p> <p> If <b>Range mode</b> is selected, enter the upper and lower limit to define the switch points.</p>  <p> <b>17</b> Example: relay output configured in the range mode as an NC contact</p> <p>NC Normally closed                      0 Closed relay                      1 Open relay                      M Measured value                      Min Switch point Min                      Max Switch point Max                      H Hysteresis</p> <p> If <b>Trigger mode</b> is selected, enter the value to define the switch point.</p>  <p> <b>18</b> Example: relay output configured in the trigger mode as an NC contact</p> <p>NC Normally closed                      0 Closed relay                      1 Open relay                      M Measured value                      P Switch point                      H Hysteresis</p>	<ul style="list-style-type: none"> <li>▪ Range mode</li> <li>▪ Trigger mode</li> </ul>	Range mode
Switch point	<p><i>Prerequisite:</i>  <b>Trigger mode</b> is selected in the <b>Output mode</b> parameter.                      Set the value at which the relay changes its switch status, while paying attention to the measuring range limits →  80 and concentration app data sheet.</p>	Positive decimal	<ul style="list-style-type: none"> <li>▪ Analysis parameter 1...n: depends on the selected concentration app</li> <li>▪ Temperature: 60.00</li> <li>▪ Speed of sound: 1500.00</li> <li>▪ Density: 1000.00</li> </ul>
Switch point Max	<p><i>Prerequisite:</i>  <b>Range mode</b> is selected in the <b>Output mode</b> parameter.                      Set the upper limit at which the relay changes its switch status, while paying attention to the measuring range limits →  80 and concentration app data sheet.</p>	Positive decimal	<ul style="list-style-type: none"> <li>▪ Analysis parameter 1...n: depends on the selected concentration app</li> <li>▪ Temperature: 120.00</li> <li>▪ Speed of sound: 2000.00</li> <li>▪ Density: 1500.00</li> </ul>



Parameter	Procedure	Selection/input	Factory setting
Switch point Min	<p><i>Prerequisite:</i>  <b>Range mode</b> is selected in the <b>Output mode</b> parameter.            Set the lower limit at which the relay changes its switch status, while paying attention to the measuring range limits → 80 and concentration app data sheet.</p>	Positive decimal	<ul style="list-style-type: none"> <li>▪ Analysis parameter 1...n: depends on the selected concentration app</li> <li>▪ Temperature: 0.00</li> <li>▪ Speed of sound: 500.00</li> <li>▪ Density: 500.00</li> </ul>
Hysteresis	<p>Enter the tolerance value for the switch points.</p> <p> Entering a hysteresis prevents the relay from switching back and forth around the upper and lower limits. The unit for the hysteresis is identical to the unit of the measured variable.</p>	Positive decimal	0.00
NC contact/NO contact	Select the switching behavior of the relay.	<ul style="list-style-type: none"> <li>▪ NC contact</li> <li>▪ NO contact</li> </ul>	NC contact
Output	Select the measured variable to which the relay output should react.	<ul style="list-style-type: none"> <li>▪ Analysis parameter 1...n</li> <li>▪ Temperature</li> <li>▪ Speed of sound</li> <li>▪ Density</li> <li>▪ Dispersion</li> <li>▪ Deactivate relay output (can only be selected via the transmitter)</li> </ul>	Temperature

### 10.4.7 Configuring the measured value display

The measured value display is configured via various menus in the transmitter with a touch screen and in the Viewer.

Navigation using transmitter with touch screen



1. Settings menu → "View settings"
2. Settings menu → "View settings" → "View"
3. Settings menu → "Application parameters" → "Averaging" → Select measured variable
4. Settings menu → "Application parameters" → "Averaging" → Select the "Temperature" measured variable → "Kalman filter"

Navigation using the Viewer

1. Menu "Teqwave Transmitter" → "View settings"
2. Menu "Teqwave Transmitter" → "Averaging" → Select measured variable
3. Menu "Teqwave Transmitter" → "Averaging" → Select the "Temperature" measured variable → "Kalman filter"

 The operating tool communicates the settings to the transmitter as soon as the **Apply** button is clicked.

## Parameter overview with brief description

Parameter	Procedure	Selection/input	Factory setting
Display settings	<p><b>Transmitter</b> Tap the measured variable to show or hide it on the transmitter's operational display.</p> <p><b>Viewer</b> Under <b>Display</b>, use the options <b>Yes</b> or <b>No</b> to choose which transmitter measured variables are displayed or not.</p>	<ul style="list-style-type: none"> <li>■ Analysis parameter 1...n</li> <li>■ Temperature</li> <li>■ Speed of sound</li> <li>■ Density</li> <li>■ Dispersion</li> </ul>	All the measured variables are displayed.
View (transmitter)	Choose how many measured variables are shown on the transmitter's operational display.	<ul style="list-style-type: none"> <li>■ 3 elements</li> <li>■ 5 elements</li> <li>■ 7 elements</li> </ul>	3 elements
Averaging	<p>Select averaging over a number of measuring points for the selected measured variable</p> <p>Example of averaging for the "Density" measured variable</p> <ul style="list-style-type: none"> <li>■ User entry: 5</li> <li>■ Output: averaging across 5 measuring points or over a period of 0.5 s (measuring frequency = 10 Hz)</li> </ul> <p> The analysis parameters are still calculated using the non-averaged measured values.</p>	Positive integer 1 to 1000	<ul style="list-style-type: none"> <li>■ Analysis parameter 1...n: 50</li> <li>■ Temperature: 5</li> <li>■ Speed of sound: 50</li> <li>■ Density: 50</li> <li>■ Dispersion: 50</li> </ul>
Kalman filter	<p>Apply the Kalman filter for displaying the temperature by activating the function.</p> <p> When the Kalman filter is enabled, the measuring device uses surface wave information, in addition to the measured value of the integrated temperature chip, for temperature measurement. This allows the sensor to follow variations in temperature more quickly. However, the sensor then needs more time to reach the stationary full scale value.</p>	Enable/disable the function	The function is disabled.

### 10.4.8 Configuring the touch screen

The touch screen is configured via the local display. The **User settings** menu contains all the parameters for configuring the display.





 If the transmitter is located in the stainless steel housing, to configure the touch screen the housing must be opened and the housing cover removed in order to gain access to the touch screen.



Navigation using transmitter with touch screen

1. Settings menu → "User settings" → "Brightness"
2. Settings menu → "User settings" → "Time settings" → "User time"
3. Settings menu → "User settings" → "Time settings" → "User date"
4. Settings menu → "User settings" → "Screensaver" → "Deactivated"
5. Settings menu → "User settings" → "Screensaver" → "Reduce brightness" → "Brightness"

6. Settings menu → "User settings" → "Screensaver" → "Reduce brightness" and "Display turn off" → "Time settings" → "Start after"
7. Settings menu → "User settings" → "Screensaver" → "Reduce brightness" and "Display turn off" → "Time settings" → "Time unit"
8. Settings menu → "User settings" → "Screensaver" → "Reduce brightness" and "Display turn off" → "Lock display"
9. Settings menu → "User settings" → "Screensaver" → "Reduce brightness" and "Display turn off" → "Unlock password"
10. Settings menu → "User settings" → "Password protection" → "App"
11. Settings menu → "User settings" → "Password protection" → "Settings"

*Parameter overview with brief description*

Parameter	Procedure	Selection/input	Factory setting
Brightness	Enter screen brightness.  If the screensaver is enabled, the value entered here must be greater than the minimum value for the screensaver.	20 to 100 %	100%
User time	Enter the current, local time.  The user time is used in the measurement chart and to save the measured values.	Entry format HH:MM:SS	The current time is set
User date	Enter the current date.	Entry format DD.MM.YY	The current date is set.
Deactivated	Tap the option to activate/deactivate the screensaver.  The display is unlocked by entering the unlock password. This function protects the entire measuring device from unauthorized access or modification. To only protect settings, select Settings → User settings → Unlock password → Settings.	Enable/disable the function	The function is disabled.
Brightness	Enter the brightness for the background lighting after the screensaver has been activated.  The value must be less than the value specified for normal screen brightness.	20 to 100 %	100%
Start after	Set the time that passes until the display reduces the brightness or the display lock is activated.	Depends on the time unit selected <ul style="list-style-type: none"> <li>▪ 30 to 7200 s or</li> <li>▪ 1 to 120 min or</li> <li>▪ 1 to 2 h</li> </ul>	60 s
Time unit	Set the time unit.  The value is automatically converted if the unit is changed.	<ul style="list-style-type: none"> <li>▪ Seconds</li> <li>▪ Minute(s)</li> <li>▪ Hour(s)</li> </ul>	Seconds
Lock display	Enable or disable the display lock.	Enable/disable the function	The function is disabled.
Unlock password	Enter the unlock password to unlock the display.	4-digit character string or numerical sequence	LSC2

Parameter	Procedure	Selection/input	Factory setting
App	<p>To prevent an unauthorized concentration app change, enter the password and enable the function. When you tap the <b>Password</b> button the text editor opens where you can enter the password. Tap the <b>Activate / Deactivate</b> button to activate or deactivate the password.</p> <p> To protect the entire system from being used and modified, activate the display lock under Settings → User settings → Screensaver → Display turn off → Lock display.</p>	<ul style="list-style-type: none"> <li>■ 4-digit character string or numerical sequence</li> <li>■ Enable/disable the function</li> </ul>	LSC2
Settings	<p>To protect access to the settings (apart from the <b>Select concentration app</b> function), enter the password and enable the function. When you tap the <b>Password</b> button the text editor opens where you can enter the password. Tap the <b>Activate / Deactivate</b> button to activate or deactivate the password.</p> <p> To protect the entire system from being used and modified, activate the display lock under Settings → User settings → Screensaver → Display turn off → Lock display.</p>	<ul style="list-style-type: none"> <li>■ 4-digit character string or numerical sequence</li> <li>■ Enable/disable the function</li> </ul>	LSC2

### 10.4.9 Configuring the failsafe mode

The menus **Diagnosis** (transmitter with touch screen) and **View filter** (Viewer) contain functions to define how the device behaves when limit values are breached (under/over range). In addition, they also contain settings for the evaluation of the measurement results that are shown on the transmitter display.



Navigation using transmitter with touch screen

1. Settings menu → "Application parameters" → "Diagnosis" → "View options"
2. Settings menu → "Application parameters" → "Diagnosis" → "Change in" → Select measured variable
3. Settings menu → "Application parameters" → "Diagnosis" → "Process disturbance" → "Switch point"

Navigation using the Viewer

1. Menu "Teqwave Transmitter" → "View filter" → "Filter options" and "Filter arrangements"
2. Menu "Teqwave Transmitter" → "View filter" → "Change in" → Select measured variable
3. Menu "Teqwave Transmitter" → "View filter" → "Process disturbance" → "Switch point"

## Parameter overview with brief description

Parameter	Procedure	Selection/input	Factory setting
Display options (transmitter) Filter options/filter arrangements (Viewer)	Select filter options and arrangements to enable or disable them.	Filter options: <ul style="list-style-type: none"> <li>■ Measuring range limits</li> <li>■ Calibration range limits</li> <li>■ Stationarity</li> </ul> Filter arrangements: <ul style="list-style-type: none"> <li>■ Hide measured value</li> <li>■ Background coloring</li> <li>■ Hold measured value</li> </ul>	The "Measuring range limits" and "Calibration range limits" options are enabled. The "Stationarity" option is disabled.
Change in analysis parameter 1...n [unit]	Specify the limit value for the maximum permissible speed at which the analysis parameter can change. Enable or disable the function using the button.  If the measuring unit is changed, the unit is changed according to the "change in" setting, but the value entered is not converted.	0.01 ... 100 [unit]	100 [unit] The function is disabled.
Change in temperature °C/min (°F/min; °K/min)	Specify the limit value for the maximum permissible speed at which the temperature can change. Enable or disable the function using the button.  If the measuring unit is changed, the unit is changed according to the "change in" setting, and the value entered is converted.	0.01 to 100 °C/min (K/min) or 0.018 to 180 °F/min	1.5 °C/min The function is enabled.
Change in speed of sound (m/s)/s	Enter the limit value for the maximum permissible speed at which the speed of sound can change. Enable or disable the function using the button.	0.01 to 100 (m/s)/s	100 (m/s)/s The function is enabled.
Change in density [unit]	Enter the limit value for the maximum permissible speed at which the density can change. Enable or disable the function using the button.  If the measuring unit is changed, the unit is changed according to the "change in" setting, and the value entered is converted.	0.01 to 100 (kg/m <sup>3</sup> )/s or (g/l)/s 0.00001 to 0.10 (g/cm <sup>3</sup> )/s	100 (kg/m <sup>3</sup> )/s The function is enabled.

Parameter	Procedure	Selection/input	Factory setting
Change in dispersion 1/s	Enter the limit value for the maximum permissible speed at which the dispersion can change. Enable or disable the function using the button.	0.01 to 100 1/s	100 1/s The function is disabled.
Switch point	<p>Set the trigger value for process disturbances (dispersion).</p> <p><b>Transmitter</b> Enable or disable the function using the <b>Enable / Disable</b> button.</p> <p><b>Viewer</b> Enable or disable the function using the <b>Process disturbance activated</b> button.</p> <p> If the speed of sound and temperature are used for concentration measurement, do not exceed the value of 1. If the density is used, use a switch point of 0.25.</p> <p>If the measured dispersion is greater than the configured switch point, the measuring device no longer displays an analysis parameter.</p>	0.01 ... 1	0.3 The function is disabled.



## 10.5 Advanced settings

Offsets, compensations and field calibrations can be performed to increase measuring accuracy. Furthermore, with the recipe generator it is possible to save combinations of settings as an initial setting or recipe for every concentration app.

### 10.5.1 Recipe generator

The recipe generator in the Viewer allows users to permanently save initial settings (unit, measuring range and offset) of an analysis parameter and compensation values for a concentration app. The initial settings are saved as a recipe in rcp format. Once a recipe has been saved, it can be added to the transmitter so that the initial setting is available in the transmitter. Any number of recipes can be created for a concentration app. However, together a maximum of 25 concentration apps and recipes can be used on the transmitter.

#### Creating or changing a recipe

1. Select the menu "Teqwave Viewer" → "Recipe generator".
  - ↳ The "Recipe generator" window appears.
2. Click the "Load concentration app/recipe" button.
  - ↳ The "Enter path of file(s)" window appears.
3. Select the concentration app file (saved locally or on the DVD) for which a new recipe should be created or select the recipe file that is to be changed. Concentration app files are in lmf format and recipe files in rcp format.
  - ↳ The initial setting options of a concentration app or recipe are displayed in the recipe generator.
4. Enter a unique name for the recipe in the "Recipe name" field. The name may contain a maximum of 64 characters, and can consist of any string of letters and numbers.
5. Make initial settings. Set concentrations 1...3 →  55; set compensation values →  55.

6. Use the "Save" button to save the recipe.
  - ↳ The "Enter path of file(s)" window appears.
7. Select the path and file name to save the recipe. A new recipe has been created: the recipe name is the default for the file name but it may be overwritten if the user requires; a recipe has been edited: either overwrite the rcp file or save the settings under another file name.

**Setting the concentration 1...3**

The unit, measuring range and offset for the concentrations calculated in a concentration app can be preset with the recipe generator and saved for permanent use.

- ▶ In the recipe generator, select the [Concentration 1...3] tab and make the initial settings, see the Parameter overview with brief description.

*Parameter overview with brief description*

Parameter/function	Procedure	Selection/input	Factory setting
Unit	Select the unit for concentration.	Depends on the selected concentration app.	Depends on the selected concentration app.
Measuring range in the selected unit	Set the upper and lower measuring range limit using the slider or entry field.	The minimum and maximum values are specified by the calibration range limits saved in the concentration app.	Calibration range limits
Offset in the selected unit	Enter the value for the concentration offset.	Floating point number with sign	0.00

**Setting the compensation values**

To increase measuring accuracy, predefined compensation values can be used for the compensation of the speed of sound and acoustic density specifically for your application. The compensation values can be read into a recipe from external measuring devices via Modbus TCP or entered as constant measured values.



Typical compensation values are:

- Operating pressure
- CO<sub>2</sub> concentration
- Degree of inversion
- Mineralization
- Physical density
- Acid content
- Sugar concentration

 Compensation values are only available if they were provided in the data record of the concentration app upon delivery.

- ▶ Set the compensation values in the "Compensation values" section of the recipe generator, see the Parameter overview with brief description.

*Parameter overview with brief description*

Parameter/function	Procedure	Selection/input	Factory setting
Compensation value K1...K4	<p>Enter the compensation value as a constant value: In the selection field, select the "Fixed value" option and enter the value for the compensation value. Observe the calibration range limits →  46.</p> <p> To enter the compensation values, the user can open the conversion tool by clicking the button of the same name.</p> <p>Read the compensation value into the measuring device via Modbus TCP: Select the "Modbus [register address]" option in the selection field.</p>	<p>User entry: Positive decimal</p> <p>Options:</p> <ul style="list-style-type: none"> <li>■ "Disabled": compensation value is not taken into consideration.</li> <li>■ "Fixed value": the compensation value entered is used.</li> <li>■ "Modbus [register address]": the compensation value received via Modbus TCP is taken into consideration.</li> </ul>	<p>User entry: 0.00</p> <p>Options: Disabled</p>

**Adding a recipe to the transmitter**

Recipes which the customer has created using the recipe generator can be added to, or removed from, the transmitter with the "Manage concentration apps" function.

► Manage concentration apps →  66.

**10.5.2 Setting the compensation values**

The compensation values available for a concentration app can be configured manually via the **Select concentration app** menu (transmitter with touch screen). To use compensation values permanently in a recipe and for further information on the compensation values, see the recipe generator →  54.

*Navigation using transmitter with touch screen*

Settings menu → "Select concentration app" → Select concentration app or recipe → "Compensation values" → Select compensation value

 The **Compensation value** function can only be accessed if the concentration app was activated beforehand with the **Activate application** function.

 Compensation values are only available if they were provided in the data record of the concentration app upon delivery.



### Parameter overview with brief description

Parameter/function	Procedure	Selection/input	Factory setting
Compensation value 1...4	<p>Enter the compensation value as a constant value: In the "Compensation" selection field, select the "Fixed value" option and enter the value for the compensation value. Observe the calibration range limits → 46.</p> <p>Read the compensation value into the measuring device via Modbus TCP: Select the "Modbus" option in the "Compensation" selection field. Modbus register information → 39.</p> <p> Access to the compensation values is only possible for the active concentration app. However, the settings are kept if the user switches concentration app.</p>	<p>User entry: Positive decimal</p> <p>Options:</p> <ul style="list-style-type: none"> <li>▪ "Disabled": compensation value is not taken into consideration.</li> <li>▪ "Fixed value": the compensation value entered is taken into consideration.</li> <li>▪ "Modbus": the compensation value received via Modbus TCP is taken into consideration.</li> </ul>	<p>User entry: 0.00</p> <p>Options: Disabled</p>

### 10.5.3 Setting the concentration offset

Manual offsets are configured for the calculated concentrations via the menus **Select concentration app** (transmitter with a touch screen) and **Concentration offset** (Viewer). This allows users to adapt the measuring technology to different process conditions (e.g. foreign substances/admixtures).

 For information on using a concentration offset in a recipe, see the recipe generator → 54.

#### Navigation using transmitter with touch screen

Settings menu → Select concentration app → "Medium settings" → "Concentration 1...3 offset"

 The **Medium settings** function can only be accessed if the concentration app was activated beforehand with the **Activate application** function.

#### Navigation using the Viewer

Menu "Teqwave Transmitter" → "Concentration offset" → "Offset"

 The operating tool communicates the settings to the transmitter as soon as the **Apply** button is clicked.

### Parameter overview with brief description



Parameter/function	Procedure	Selection/input	Factory setting
Concentration 1...3 offset (transmitter) Concentration 1...3/ [unit] (Viewer)	<p>Enter the value for the concentration offset.</p> <p> Access to the offset setting is only possible for the active concentration app or the active recipe. However, the settings are kept if the user switches concentration app.</p>	Floating point number with sign	0.00

### 10.5.4 Performing field calibration with a medium

Different conditions when the concentration app is created in the laboratory compared with real-life process conditions can lead to undesired effects. Measurement accuracy can be increased by performing a **field calibration** under process conditions. The field

calibration can only be performed using the transmitter with a touch screen and also only for concentration apps that do not output more than two analysis parameters.

If a field calibration is performed, it only applies to the concentration app currently in use. The field calibration is disabled if the user switches the concentration app.

**i** If a field calibration is not possible, e.g. in the case of concentration apps that output more than two analysis parameters, we recommend setting a concentration offset either manually →  57 or via the recipe generator →  54.

#### NOTICE

##### Measurement result is not representative

Changes to the process conditions after performing a field calibration can cause incorrect measurement results.

- ▶ Ensure process conditions are uniform after the field calibration. In particular, keep the flow, pressure and droplet size distribution constant.
- ▶ After the field calibration, do not take any actions that could alter the properties of the medium (exception: material composition as per concentration app).

#### Navigation

"Settings" → "Application parameters" → "Field calibration"

#### Performing field calibration with a medium

**i** To perform a field calibration, it is necessary to fill the measuring device with a medium .

1. Create a reference calibration point via the function "Settings" → "Application parameters" → "Field calibration" → "Manage calibration points" → "Add new calibration point".
  - ↳ The transmitter displays the following message: "Values are being recorded. Please wait until the process has finished"  
When the process has been completed successfully, the "Manage calibration points" menu displays the recorded calibration point.  
Up to two calibration points can be recorded. If a two-point calibration is performed, Endress+Hauser recommends capturing two different states of the liquid. Different states can be different temperatures or concentrations. The process conditions must remain constant here. If necessary, remove a calibration point with the "Delete calibration point" function to make it possible to record a new calibration point.
2. Enter the target concentration values in the fields "Settings" → "Application parameters" → "Field calibration" → "Manage calibration points" → "Target concentration 1/2".
3. Recalculate the calibration data via the function "Settings" → "Application parameters" → "Field calibration" → "Calculate calibration data". Two options are available: select "Adjust input values" to correct the speed of sound and the density. This is recommended if external factors affect the speed of sound or density (e.g. pressure or salinization). Select "Adjust output values" to correct the concentration 1...2.
  - ↳ If the process is completed successfully, the message "Process successful" appears briefly on the screen. The "Field calibration" menu then displays the calibration data.
4. Apply the field calibration via the function "Settings" → "Application parameters" → "Field calibration" → "Apply calibration".
  - ↳ Corrected measured value display.
5. Check the measured values.

## 10.6 Application package "Viewer with interface for data download"

### 10.6.1 Availability

If the "Viewer with interface for data download" application package is ordered from the factory, the functions of this package are available in the Viewer when the device is delivered.

Ways to check function availability:

Using the serial number on the measuring device: W@M Device viewer → order code option EP "Viewer with interface for data download"

Via the "Viewer" operating tool:

Check whether the functions appear in the Viewer. The function is activated if the **Read memory** function is not grayed out in the **Teqwave Transmitter** menu.

If the function cannot be opened in the measuring device, the application package was not selected when the device was ordered. In this case, you can subsequently activate the functions for data readout.

### 10.6.2 Activation

Endress+Hauser provides users with a license key to activate the functions. The license key must be entered to enable the functions of the application package. The key is entered in the Viewer via the "Teqwave Transmitter" → "License key" menu.

The application package is individually licensed for a specific measuring device and can only be used with this particular device. The system uses a serial number saved in the license key to automatically check whether there is authorization to enable the application package on the connected transmitter.

### 10.6.3 General information

The "Viewer with interface for data download" application package is only available via the Viewer. Once the application package has been enabled, it is possible to open the measured values that are saved in the memory via the **Read memory** function. It is also possible to save the measured data and physical units to a .csv file. This file can be imported into a database. If the application package has not been enabled, the corresponding functions are disabled in the Viewer and it is not possible to access the measured data.

 For more information on retrieving measured data, see →  65.

### 10.6.4 Device memory disk space

Once the internal memory is full, the most recent data records overwrite the oldest data records. There are 2 GB of space available on the internal memory. With a storage interval of 60 s, there is enough space in the memory for approx. 7.5 years.

### 10.6.5 Specifying the storage interval

A storage interval of 10 to 7 200 s can be defined for data storage. The storage interval refers to the frequency at which the data are saved to the device memory.

*Navigation using transmitter with touch screen*

Settings menu → "Application parameters" → "Storage interval (s)"

*Navigation using the Viewer*

Menu "Teqwave Transmitter" → "Storage interval"

 The operating tool communicates the settings to the transmitter as soon as the **Apply** button is clicked.

*Parameter overview with brief description*

Parameter	Procedure	Selection/input	Factory setting
Storage interval (s)	<p>Select the time interval in which the measured values are written to the internal memory.</p> <p> The function only applies if the application package <b>with interface for data download</b> is installed.</p>	Positive integer 10 to 7200 s	60 s

# 11 Operation

## 11.1 Changing the operating language

Operating language settings →  42.

## 11.2 Configuring the local display

Local display settings →  50.

## 11.3 Reading measured values via the local display

### 11.3.1 Reading measured values

All the current measured values can be read via the **operational display** of the transmitter with a touch screen. When a measured variable is selected, the local display switches to the graph display. The graph shows the development of the selected measured variable over time. The graph display format can be adjusted.

**NOTICE**

**Double measured value display of alcohol concentration in the "Distillery; sugar, invert sugar, alcohol" application package**

Concentration apps where the physical density can be compensated display the alcohol concentration twice.

- ▶ For more information see the channel description in the data sheet of the concentration app.

### 11.3.2 Adjusting the graph display format

*Navigation using transmitter with touch screen*



1. "Select measured variable" → "Graph settings button" → "Time axis"
2. "Select measured variable" → "Graph settings button" → "Y-axis" → "Maximum value [unit]"
3. "Select measured variable" → "Graph settings button" → "Y-axis" → "Minimum value [unit]"
4. "Select measured variable" → "Graph settings button" → "Y-axis" → "Auto scale"

*Parameter overview with brief description*

Parameter	Procedure	Selection/input	Factory setting
Time axis	Select the period shown on the X-axis.	<ul style="list-style-type: none"> <li>▪ 1 minute</li> <li>▪ 10 minutes</li> <li>▪ 1 hour</li> <li>▪ 4 hours</li> <li>▪ 12 hours</li> <li>▪ 1 day</li> <li>▪ 1 week</li> <li>▪ 1 month</li> <li>▪ 3 months</li> </ul>	1 minute
Maximum value [unit]	Enter the maximum value to be displayed on the Y-axis.	Floating point number with sign	<ul style="list-style-type: none"> <li>▪ Analysis parameter: depends on the selected concentration app.</li> <li>▪ Temperature: 120 °C</li> <li>▪ Speed of sound: 2000 m/s</li> <li>▪ Density: 1500 kg/m<sup>3</sup></li> <li>▪ Dispersion: 1</li> </ul>

Parameter	Procedure	Selection/input	Factory setting
Minimum value [unit]	Enter the minimum value to be displayed on the Y-axis.	Floating point number with sign	<ul style="list-style-type: none"> <li>▪ Analysis parameter: depends on the selected concentration app.</li> <li>▪ Temperature: 0 °C</li> <li>▪ Speed of sound: 500 m/s</li> <li>▪ Density: 500 kg/m<sup>3</sup></li> <li>▪ Dispersion: 0</li> </ul>
Auto scale	Select to enable or disable auto scaling of the graph.	Enable/disable the function	The function is enabled.

### 11.3.3 Graph tools

Button	Description
	<b>Settings</b> Navigate to the graph settings.
	<b>Cursor position</b> Select the cursor position in the graph for the desired measured value display.
	<b>Delete</b> Clears the graph. The graph representation then resumes.

## 11.4 Reading measured values via the operating tool

### 11.4.1 Reading measured values

The Viewer presents the measured data in graph and text form on the start screen. The **Live Viewer** mode is automatically activated once the transmitter is connected.

 Following an offline analysis of the data, the "Teqwave Viewer" → "Live Viewer" menu allows users to switch to the Live View.

#### NOTICE

**Double measured value display of alcohol concentration in the "Distillery; sugar, invert sugar, alcohol" application package**

Concentration apps where the physical density can be compensated display the alcohol concentration twice.

- ▶ For more information see the channel description in the data sheet of the concentration app.

### 11.4.2 Adjusting the graph display format

*Navigation using the Viewer*



1. Menu "Teqwave Viewer" → "Graph settings" → "Y-axis 1"
2. Menu "Teqwave Viewer" → "Graph settings" → "Y-axis 2"
3. Menu "Teqwave Viewer" → "Graph settings" → "Time axis"
4. Menu "Teqwave Viewer" → "Graph settings" → "Time interval in s"



Parameter overview with brief description

Parameter	Procedure	Selection/input	Factory setting
Time axis	Select the period shown on the X-axis.	<ul style="list-style-type: none"> <li>▪ 1 minute</li> <li>▪ 3 minutes</li> <li>▪ 5 minutes</li> <li>▪ 10 minutes</li> <li>▪ 30 minutes</li> <li>▪ 1 hour</li> <li>▪ 6 hours</li> <li>▪ 12 hours</li> <li>▪ 1 day</li> <li>▪ 7 days</li> <li>▪ 30 days</li> <li>▪ 90 days</li> </ul>	5 minutes
Y-axis 1	Select measured variables to be displayed on the left-side axis.	Depends on the measured variables enabled and the selected concentration app: <ul style="list-style-type: none"> <li>▪ Analysis parameter 1...n</li> <li>▪ Temperature</li> <li>▪ Speed of sound</li> <li>▪ Density</li> <li>▪ Dispersion</li> </ul>	Analysis parameter 1
Y-axis 2	Select measured variables to be displayed on the right-side axis.	<ul style="list-style-type: none"> <li>▪ Analysis parameter 1...n</li> <li>▪ Temperature</li> <li>▪ Speed of sound</li> <li>▪ Density</li> <li>▪ Dispersion</li> </ul>	Temperature
Time interval in s	Specify the display rate (in seconds) for retrieving the values from the transmitter.	Positive decimal	1 s

### 11.4.3 Graph tools

The graph tool kit above the graph can be used to adjust the view in the Viewer (zoom function, shifting the position of the Y-axis).

 The graph tools only work when "auto scale" is switched off →  64.

Button	Description
 <small>A0035501</small>	<b>Cursor position</b> Only for the "Read memory" function: select the cursor position in the graph for the desired measured value display.
 <small>A0035502</small>	<b>Select the zoom function</b> Open and use options to zoom in (enlarge view) and zoom out (reduce view) of the chart. <ul style="list-style-type: none"> <li>▪ <b>Rectangle zoom:</b> press and hold the left mouse button and drag the rectangle over the area you wish to zoom into.</li> <li>▪ <b>X-axis zoom:</b> press and hold the left mouse button and drag over the desired area of the X-axis.</li> <li>▪ <b>Y-axis zoom:</b> press and hold the left mouse button and drag over the desired area of the Y-axis.</li> <li>▪ <b>Adjust automatically:</b> click the icon to automatically adjust the graph.</li> <li>▪ <b>Magnify:</b> click the desired point to zoom into the graph.</li> <li>▪ <b>Reduce:</b> click the desired point to zoom out of the graph.</li> </ul>
 <small>A0035508</small>	<b>Y-axis position function</b> Move the position of the Y-axis up or down.

#### 11.4.4 Switching auto scale on and off

- ▶ Switch the "Auto scale" function on and off by right-clicking on the Y-axis.

#### 11.4.5 Clearing the graph

- ▶ Select the menu "Teqwave Viewer" → "Clear graph".
  - ↳ The graph display starts again with the "Auto scale" function switched on.

### 11.5 Accessing measured data via the operating tool

**i** It is only possible to access the **Single measurement**, **Start recording** and **Stop recording** menu items if the "Viewer with interface for data download" application package is enabled. Otherwise the menu items are grayed out and cannot be selected.

The Viewer records measured values and provides functions to retrieve the measured data.

#### 11.5.1 Saving the current measuring point to a .csv file

1. Select the menu "Teqwave Viewer" → "Single measurement".
  - ↳ The "Enter path of file(s)" window appears.
2. Select the file where the measuring point is to be saved. To save the measuring point, either create a new .csv file on the computer or select an existing .csv file on the computer.
  - ↳ The new measuring points are appended to the end of the file. Existing values are retained.

#### 11.5.2 Recording measuring points

1. Select the menu "Teqwave Viewer" → "Start recording".
  - ↳ The "Enter path of file(s)" window appears.
2. Select the file where the measuring points are to be saved. You have the following options: create a new .csv file on the computer - the measuring points will be saved to this file. Select an existing .csv file on the computer - the measuring points will be saved to this file.
  - ↳ A green indicator appears above the measured values on the start screen. The new measuring points are appended to the end of the file. Existing values are retained.

#### 11.5.3 Stop recording

- ▶ Select the menu "Teqwave Viewer" → "Stop recording".
  - ↳ The system stops recording the measuring points. The green indicator on the start screen disappears.

### 11.6 Opening measured data in the Graph View

The Viewer allows users to retrieve measured data saved earlier with the **Open data** function. These can be measured data that were retrieved from the transmitter or recorded by the Viewer.

#### 11.6.1 Opening the measured data

1. Select the menu "Teqwave Viewer" → "Open data".
  - ↳ The "Enter path of file(s)" window appears.



2. Select the desired file and click "OK" to confirm.
  - ↳ The Viewer interrupts the Live View and displays the selected data.

 The display format of the data displayed offline can be adjusted in the same way as in the Live Viewer. In this mode it is not possible to record additional data simultaneously with the Viewer.

## 11.7 Reading the device memory and saving measured data

-  It is only possible to access the **Read memory** and **Save read data** menu items if the "Viewer with interface for data download" application package is enabled. Otherwise the menu item is grayed out and cannot be selected.
  - If the volume of data is large, data readout takes some time. For this reason, it is advisable to regularly call up the data on the data memory and save the data externally.

The Viewer can read out and delete measured data recorded during the operation of the transmitter with the **Read memory** function. The Viewer saves the data with the **Save read data** function.

### 11.7.1 Reading measured data from the transmitter

1. Select the menu "Teqwave Transmitter" → "Read memory".
  - ↳ The "Saved data" window opens.
2. From the drop-down menu, select the concentration app for data read-out.
  - ↳ One file is saved on the transmitter per concentration app.
3. Click the "Read" button.
  - ↳ As soon as the download process is finished, the progress bar closes automatically and the Viewer displays the measured data in the graph format. Following an offline analysis of the data, the "Teqwave Viewer" → "Live Viewer" menu allows users to switch to the Live View.

### 11.7.2 Saving the read measured data to a .csv file

 To be able to save the measured data permanently, the data must first be read out from the transmitter.

1. Select the menu "Teqwave Transmitter" → "Save read data".
  - ↳ The "Enter path of file(s)" window appears.
2. Select the path and file name for saving the measured data.
3. Click the "OK" button to confirm.
  - ↳ The Viewer saves the measured data to a .csv file.

### 11.7.3 Deleting saved measured data from the transmitter

#### NOTICE

#### Lost data

Once data are deleted, they cannot be restored.



- ▶ Read out and save data before deleting them.

1. Select the menu "Teqwave Transmitter" → "Read memory".
  - ↳ The "Saved data" window opens.
2. From the drop-down menu, select the concentration app with the data that are to be deleted.

3. Click the "Delete" button.
  - ↳ The message "Do you really want to delete the data?" appears on the screen.
4. Select "Yes" to confirm.
  - ↳ The Viewer deletes the measured data of the selected concentration app from the transmitter's memory.

## 11.8 Managing concentration apps

The Viewer can manage concentration apps on the connected transmitter via the **Manage concentration apps** function. This function allows users to get an overview of all the concentration apps installed on the transmitter, load new concentration apps onto the transmitter and activate them, and remove concentration apps that are no longer needed from the transmitter.

 Concentration apps which the customer has preset using the recipe generator - which are known as recipes - can also be added to, or removed from, the transmitter with the **Manage concentration apps** function. For more information on the recipe generator, see →  54.

### 11.8.1 Adding a concentration app to the transmitter

 Concentration apps are individually tailored to a specific measuring device and can only be used with this particular device. The system uses a serial number saved in the concentration app file to automatically check whether there is authorization to enable the concentration app on the connected transmitter.

1. Open the "Teqwave Transmitter" → "Manage concentration apps" menu.
  - ↳ A new window appears.
2. Click the "Add" button.
  - ↳ The "Enter path of file(s)" window appears.
3. Select the concentration app file. Concentration app files are lmf format. Concentration apps preset by the customer, which are known as recipes, are in rcp format.
4. Click the "OK" button to add a new concentration app or recipe to the transmitter.

### 11.8.2 Deleting a concentration app from the transmitter



- If an active concentration app is deleted, a new concentration app must then be activated. Otherwise the system stops calculating the concentration of the liquid.
- If concentration apps that have been deleted from the transmitter are to be used again, they must be added to the transmitter again from the DVD.

1. Open the "Teqwave Transmitter" → "Manage concentration apps" menu.
  - ↳ A new window appears.
2. Select the concentration app to be deleted from the "Concentration apps" drop-down menu.
3. Click the "Delete" button.
  - ↳ The message "Do you really want to delete the data?" appears on the screen.
4. Select "Yes" to confirm.
  - ↳ The Viewer removes the concentration app from the transmitter.

## 11.9 Replacing the transmitter

Establishing a connection →  34.

## 11.10 Updating the firmware

Firmware updates must be installed via the Viewer. They are available in the Download Area of the Endress+Hauser website: [www.endress.com](http://www.endress.com) → Downloads.

Specify the following details:

- Search area: "Software"
- Software type: "Device driver" and "Firmware Flash File"

*Navigation*

Menu "Teqwave Transmitter" → "Update Transmitter"

### Updating the firmware

#### NOTICE

#### Damage to the measuring device

Disconnecting the transmitter from the power supply or the computer during the update process can damage the transmitter.

- ▶ Do not disconnect the transmitter power supply and the connection to the computer.
- ▶ Establish a direct network connection between the transmitter and the computer running the Viewer.

1. Open the menu "Teqwave Transmitter" → "Update Transmitter".
  - ↳ The "Enter path of file(s)" window appears.
2. Select the .lcu file.
3. Click "OK" to run the update.
  - ↳ The transmitter runs the update.  
Once the update process is completed, the status LED is lit green (transmitter with LED status indication) or the touch screen (transmitter with touch screen) shows the operational display.

## 12 Diagnostics and troubleshooting

### 12.1 General troubleshooting

#### 12.1.1 For the local display: transmitter with touch screen

Error	Possible causes	Remedial action
Local display dark and no output signals.	Supply voltage does not match that specified on the nameplate.	Apply the correct supply voltage.
Local display is dark, but signal output is within the valid range.	Display is set too bright or too dark.	Set the display brighter or darker via the "Teqwave Viewer" operating tool using the "Brightness" parameter.
	Display module is faulty.	Contact Endress+Hauser Service.

#### 12.1.2 For the local display: transmitter with LEDs

Error	Possible causes	Remedial action
LEDs on the measuring device are not lit and no output signals.	Supply voltage does not match that specified on the nameplate.	Apply the correct supply voltage.
LEDs on the measuring device are not lit but signal output within the valid range.	Display module is faulty.	Contact Endress+Hauser Service.

#### 12.1.3 For output signals

Error	Possible causes	Remedial action
Signal output outside the valid range.	Incorrect configuration.	<ol style="list-style-type: none"> <li>1. Check the configuration and correct if necessary.</li> <li>2. Stay within the specifications of the outputs indicated in the "Technical data".</li> <li>3. Observe the failure mode of the outputs as indicated under "Signal on alarm" in the "Technical data" section.</li> </ol>
Device shows correct value on the local display but the signal output is incorrect, though in the valid range.	Configuration error.	Check the configuration and correct if necessary.
Measured value not stable	Operation outside the range of application.	<ol style="list-style-type: none"> <li>1. Ensure homogeneous mixing of the liquid and continuous flow of liquid to the sensor.</li> <li>2. Remove air bubbles and/or particles.</li> <li>3. Ensure the temperature value is stable.</li> </ol>
	Suboptimal configuration.	Check the configuration of the "Averaging" parameter. The following values are recommended: <ul style="list-style-type: none"> <li>▪ Temperature: 10</li> <li>▪ Speed of sound: 5</li> <li>▪ Analysis parameter: 5</li> </ul>
Measuring device measures incorrectly or concentration value is zero.	Concentration app not used correctly.	Check the selected concentration app and change the concentration app if necessary.
	Communication error.	Restart the transmitter. In doing so, disconnect the device from the supply voltage for at least 30 seconds.

Error	Possible causes	Remedial action
	Operation outside the range of application.	<ol style="list-style-type: none"> <li>1. Ensure homogeneous mixing of the liquid and continuous flow of liquid to the sensor.</li> <li>2. Remove air bubbles and/or particles.</li> <li>3. Ensure the temperature value is stable.</li> </ol>
	Sensor is dirty.	Ensure that the sensor is free from dirt and deposit buildup.
	Sensor is faulty.	<ol style="list-style-type: none"> <li>1. Check the sensor with the "Check sensor" function.</li> <li>2. Contact Endress+ Hauser-Service if the limit value is exceeded.</li> </ol>

### 12.1.4 For access via the "Teqwave Viewer" operating tool

Problem	Possible causes	Remedial action
Not possible to connect to the "Teqwave Viewer" operating tool.	Cable is not connected.	Connect the network cable to the transmitter.
	Cable too long.	Check the cable length (max. 30 m) and correct if necessary.
	Internet protocol configured incorrectly.	Check the configuration of the Internet protocol and correct if necessary.
The permanent connection to the "Teqwave Viewer" operating tool disconnected after a few days.	Internet protocol has been changed. Check the configuration of the Internet protocol.	Check the configuration of the Internet protocol and correct if necessary.
	Measuring device is connected to several operating tools.	Only establish a single link to maintain a permanent connection.
Error message when running the "Read memory" function.	Network connection has been interrupted.	Ensure uninterruptible network connection.
Measured values from 1904 appear in the graph after reading the memory.	Communication error or device memory faulty.	<ol style="list-style-type: none"> <li>1. Restart the transmitter. In doing so, disconnect the device from the supply voltage for at least 30 seconds.</li> <li>2. Read the memory again.</li> <li>3. If the error persists, contact the Endress+ Hauser Service.</li> </ol>
All measured values appear with the value zero after reading the memory.	Communication error or device memory faulty.	<ol style="list-style-type: none"> <li>1. Restart the transmitter. In doing so, disconnect the device from the supply voltage for at least 30 seconds.</li> <li>2. Read the memory again.</li> <li>3. If the error persists, contact the Endress+ Hauser Service.</li> </ol>

## 12.2 Diagnostics information for transmitter with LED status indication

Four light emitting diodes (LEDs) on the transmitter provide information on the condition of the device.

### Transmitter with LED status indication

LED	Signal	Meaning
Power	Lit green	Supply voltage connected, initialization completed.
Error	Lit red	Measuring system error; read exact error code with the Viewer.
Sensor ok	Lit green	The sensor is working perfectly.

LED	Signal	Meaning
	Flashes	<p>The measurement is not stable and/or at least one of the measured variables is outside the valid range. This can be caused by the following system conditions:</p> <ul style="list-style-type: none"> <li>▪ <b>Measuring range limits exceeded/undershot:</b> At least one of the measured variables has breached its configured permitted range.</li> <li>▪ <b>Calibration range limits exceeded/undershot:</b> At least one of the measured variables (temperature or concentration) has breached its permitted calibration range.</li> <li>▪ <b>Change in temperature too high:</b> The change in the temperature of the liquid has exceeded the limit value saved in the transmitter. Wait until the liquid is stable again.</li> <li>▪ <b>Change in concentration too high:</b> The change in the concentration of the liquid has exceeded the limit value saved in the transmitter. Wait until the liquid is stable again.</li> </ul>
Sensor error	Lit red	<p>Sensor error. Read exact error code with the Viewer. The following errors are possible:</p> <ul style="list-style-type: none"> <li>▪ <b>No liquid present:</b> Ensure that there is sufficient bubble-free liquid in the sensor.</li> <li>▪ <b>No sensor connected:</b> Ensure that the sensor is connected to the transmitter via the connecting cable.</li> </ul>

## 12.3 Diagnostic information on local display and in operating tool

The transmitter with a touch screen and the "Teqwave Viewer" operating tool indicate errors and malfunctions by green, yellow and red indicators. Tap this sensor status to display the current messages in text format.

Signal color	Diagnostic message	Description	Measures
Green	"Sensor Status OK"	-	-
Yellow	"Change in temperature > [limit value]"	Temperature of liquid changes too quickly and configured limit value is exceeded. The calculated measured value may be incorrect.	Ensure a stable medium temperature.
	"Change in concentration > [limit value]"	Concentration of liquid changes too quickly and configured limit value is exceeded. The calculated measured value may be incorrect.	Ensure a stable medium concentration.
	"Process disturbance detected, dispersion > [limit value]"	The measured dispersion is greater than the configured switch point.	<ol style="list-style-type: none"> <li>1. Remove air bubbles and/or particles.</li> <li>2. Take the recommended mounting position into consideration →  20.</li> </ol>
	"Stationarity"	The concentration of the liquid changes too quickly and the measured value changes more frequently within 20 s than allowed by the statistical uncertainty considered in the measuring device. Settling processes can occur. The calculated measured value may be incorrect.	Ensure a stable medium concentration.
	"Measuring range [measured variable] < ; [measured variable] >"	The measured value is above or below the specified measuring range limits.	Select a measured value that is within the measuring range limits.
	"Calibration [measured variable] < ; [measured variable] >"	The measured value for the displayed measured variable is above or below the calibration range of the liquid and may therefore be incorrect.	Select a measured value that is within the calibration range.
	"Clock and storage faulty"	Buffer battery is not charged.	<ol style="list-style-type: none"> <li>1. Supply power to the transmitter for a few hours.</li> <li>2. Then restart the transmitter.</li> <li>3. If the error persists, contact Endress+Hauser-Service.</li> </ol>
	"Compensation not possible: Modbus communication faulty"	Missing compensation value.	<ol style="list-style-type: none"> <li>1. Check the functional integrity of the external measuring devices.</li> <li>2. Check and guarantee Modbus communication with external measuring devices.</li> </ol>

Signal color	Diagnostic message	Description	Measures
	"Analog interface disabled"	The analog interface is disabled.	Enable the interface by selecting a measured variable in the <b>Analog channel 1...4</b> parameter.
	"Compensation value is incorrect"	Compensation calculation is not possible. Missing compensation value.	Enter the compensation value in the <b>Compensation value K1...K4</b> parameter.
Red	"No liquid present"	No liquid is present.	Ensure that there is sufficient liquid in the sensor.
		Sensor is dirty.	Ensure that the sensor is free from dirt and deposit buildup.
		Air bubbles or particles in the liquid.	Remove air bubbles and/or particles.
		Communication error	Restart the transmitter. In doing so, disconnect the device from the supply voltage for at least 30 seconds.
	"No sensor connected"	The sensor is not connected.	Make sure that the sensor is connected to the transmitter via the connecting cable.
		Connecting cable or connections are damaged.	Check the connecting cable and connections for damage.
		Communication error	Restart the transmitter. In doing so, disconnect the device from the supply voltage for at least 30 seconds.
	"Temperature chip is faulty"	Sensor is faulty.	Contact Endress+Hauser Service.
	"Temperature chip is faulty"	Sensor is faulty.	Contact Endress+Hauser Service.
	"Sensor memory faulty"	Measuring device is initializing.	Contact Endress+Hauser Service.
	"Process disturbance"	The value measured for the dispersion is greater than 1.	<ol style="list-style-type: none"> <li>1. Remove air bubbles and/or particles.</li> <li>2. Take the recommended mounting position →  20 into consideration.</li> <li>3. If the error persists, contact Endress+Hauser-Service.</li> </ol>
	"Sensor configuration failed"	Missing calibration.	Contact Endress+Hauser Service.
	"System error"	Communication error between internal processors.	<ol style="list-style-type: none"> <li>1. Restart the transmitter.</li> <li>2. If the error persists, contact Endress+Hauser-Service.</li> </ol>
"Compensation value is incorrect"	Compensation calculation is not possible. Missing compensation value.	Enter the compensation value in the <b>Compensation value K1...K4</b> parameter.	

## 12.4 Diagnostics information for transmitter with LED status indication

Four light emitting diodes (LEDs) on the transmitter provide information on the condition of the device.

### Transmitter with LED status indication

LED	Signal	Meaning
Power	Lit green	Supply voltage connected, initialization completed.
Error	Lit red	Measuring system error; read exact error code with the Viewer.
Sensor ok	Lit green	The sensor is working perfectly.

LED	Signal	Meaning
	Flashes	<p>The measurement is not stable and/or at least one of the measured variables is outside the valid range. This can be caused by the following system conditions:</p> <ul style="list-style-type: none"> <li>▪ <b>Measuring range limits exceeded/undershot:</b> At least one of the measured variables has breached its configured permitted range.</li> <li>▪ <b>Calibration range limits exceeded/undershot:</b> At least one of the measured variables (temperature or concentration) has breached its permitted calibration range.</li> <li>▪ <b>Change in temperature too high:</b> The change in the temperature of the liquid has exceeded the limit value saved in the transmitter. Wait until the liquid is stable again.</li> <li>▪ <b>Change in concentration too high:</b> The change in the concentration of the liquid has exceeded the limit value saved in the transmitter. Wait until the liquid is stable again.</li> </ul>
Sensor error	Lit red	<p>Sensor error. Read exact error code with the Viewer. The following errors are possible:</p> <ul style="list-style-type: none"> <li>▪ <b>No liquid present:</b> Ensure that there is sufficient bubble-free liquid in the sensor.</li> <li>▪ <b>No sensor connected:</b> Ensure that the sensor is connected to the transmitter via the connecting cable.</li> </ul>

## 12.5 Diagnostic information via dispersion indicator

The dispersion indicates a disturbance in the liquid caused by the dispersion of gas bubbles or particles. This causes a widening in the group and phase speed of sound.

The measuring device displays a standardized factor. If this value is less than 1, this indicates that the speed of sound determined for the undisturbed fluid can still be determined with the specified measured error. On the other hand, the density measured error can already be greater than the measured error specified under reference conditions at values over 0.25.

Therefore, if the speed of sound and temperature are used for concentration measurement, the value of 1 should not be exceeded. If the density is used, the value of 0.25 should not be exceeded.

If the measured dispersion is greater than the configured switch point, the measuring device no longer displays the concentration or analysis parameter. The configured switch point can be viewed as follows:

Navigation using transmitter with touch screen: "Settings" → "Application parameters" → "Diagnosis" → "Process disturbance" → "Switch point"

Navigation using the Viewer: menu "Teqwave Transmitter" → "View filter" → "Process disturbance" → "Switch point"

## 12.6 Testing the sensor

The **Sensor testing** function in the Viewer allows users to test the accuracy of the sensor. A test report is created for documentation purposes.

*Navigation using the Viewer*

Menu "Teqwave Transmitter" → "Sensor testing"

### NOTICE

#### Incorrect test result

The use of tap water and the presence of air bubbles or variable environmental conditions (e.g. variations in temperature or flow) can corrupt the test result.

- ▶ Clean the sensor before performing the test.
- ▶ Only use distilled or fully deionized water (conductivity < 20 µS/cm) to test the sensor.
- ▶ Boil the liquid for several minutes to prevent air bubbles occurring.
- ▶ Ensure constant environmental conditions.

1. Open the menu "Teqwave Transmitter" → "Sensor testing".
  - ↳ A message appears with information on the preparatory steps.
2. Fill the sensor completely with distilled or completely deionized water.



3. Click "OK" to confirm the message.
  - ↳ View in the Viewer changes to the Test View.  
If the temperature of the liquid and sensor is stable, the message "The temperature is steady. Start sensor testing?" appears after approx. three minutes.
4. Click "OK" to confirm the message.
  - ↳ The sensor test begins.  
The test result appears in the form of a test report after a few seconds.
5. Click "OK" to save the test report as an image file (.bmp) on the computer.
  - ↳ The "Enter path of file(s)" window appears.
6. Select the path and file name for saving the .bmp file.
7. Click the "OK" button to confirm.
  - ↳ The Viewer saves the test report.
8. Check the test report. If the test values are outside the tolerance range, the sensor may need to be adjusted. In such cases, please contact your Endress+Hauser sales organization. Permitted deviations: speed of sound:  $\pm \leq 0.5$  m/s and density:  $\pm \leq 3.0$  kg/m<sup>3</sup>.

## 12.7 Resetting the measuring device to factory default settings

The entire device configuration can be reset to the as-delivered state with the **Restore factory settings** function.

 Concentration apps, recipes and application packages are not affected by the reset to factory settings.

### 12.7.1 Restoring factory settings via transmitter with touch screen

1. Select Settings menu → "Application parameters".
2. Tap the "Factory settings" function. If the "Factory settings" menu item is not visible on the touch screen, scroll down using the scroll bar.
  - ↳ Screen starts counting down from 10 to 0. At the end of the countdown, user-specific device settings are reset to the factory settings.

### 12.7.2 Restoring factory settings via the Viewer

1. Open the menu "Teqwave Transmitter" → "Restore factory settings".
  - ↳ A message is displayed.
2. Click "OK" to confirm the message.
  - ↳ The Viewer resets the user-specific device settings to the factory settings.

## 12.8 Device information

The nameplate contains device information. The **Settings** menu on the local display (transmitter with touch screen) and the **Version** function in the "Teqwave Viewer" operating tool contain additional information.

Navigation using transmitter with touch screen

1. Settings menu → "Version"
2. Settings menu → "Network settings" → "Status"
3. Settings menu → "Network settings" → "MAC address"

*Navigation using the Viewer*  
Menu "Help" → "Version" → "Show device information"

*Parameter overview with brief description*



Parameter	Description	Display
Teqwave Viewer <sup>1)</sup>	Displays the current version of the Teqwave Viewer.	Character string with the format: v.x.y.zz
Firmware or version	Displays the installed firmware version of the transmitter.	Character string with the format: v.x.y.zz or x.y.z
Hardware	Displays the hardware version of the transmitter.	Character string with the format: x.y.z
Serial number <sup>2)</sup>	Displays the serial number of the measuring device.	Max. 16-digit numerical sequence
Sensor ID	Displays the ID of the sensor.	Max. 11-digit numerical sequence
Transmitter ID	Displays the ID of the transmitter.	Max. 12-digit numerical sequence
MAC address	Displays the MAC address of the transmitter.	Byte-wise notation, colon-separated.
License key <sup>1)</sup>	Displays the license key currently used.	32-digit numerical sequence, consisting of 4 groups, separated by a hyphen.
Status	Displays the device status coded for the Service Department.	Max. 5-digit character string

1) This information is only visible in the Viewer.

2) This information can be found in the Viewer and on the nameplates.

## 12.9 Firmware history

Date	Firmware version	Order code for "Firmware version"	Changes	Documentation type	Documentation
02.2021	2.3.zz (Teqwave transmitter)	Firmware version 2.3.zz included in the delivery. Firmware version 2.2.zz available with option <b>77</b> . This corresponds to the firmware version of Teqwave F and I.	Original firmware	Operating Instructions	<ul style="list-style-type: none"> <li>■ BA02084D/06/EN/02.21</li> <li>■ BA02084D/06/EN/01.21</li> </ul>

 It is possible to flash the firmware to the current version or the previous version using the "Teqwave Viewer" operating tool →  67.

## 13 Maintenance

### 13.1 Maintenance tasks

No special maintenance work is required. Each part and accessory can be cleaned. This may require disassembly.

#### 13.1.1 Exterior cleaning

When cleaning the exterior of the measuring device, always use cleaning agents that do not corrode the material or the seals.

#### 13.1.2 Interior cleaning

The device is designed for cleaning in place (CIP). The inspection and cleaning intervals depend on the field of application.

#### NOTICE

##### Damage to the sensor

Unsuitable devices or cleaning agents as well as large and particularly rapid temperature increases can damage the sensor.

- ▶ Use an oil-free cleaning agent that does not form a film to clean the sensor. Gently clean the surface using a soft brush.
- ▶ Never use cleaning agents that can corrode the material.
- ▶ Ensure that the immediate temperature increase of the medium does not exceed 55 °C/s (99 °F/s).

#### 13.1.3 Replacing seals

The sensor's seals (particularly aseptic gasket seals) must be replaced periodically.

The interval between changes depends on the frequency of the cleaning cycles, the cleaning temperature and the medium temperature.

Replacement seals (accessory) →  78

### 13.2 Endress+Hauser services

Endress+Hauser offers a wide variety of services for maintenance such as recalibration, maintenance service or device tests.

 Your Endress+Hauser Sales Center can provide detailed information on the services.

## 14 Repair

### 14.1 General information

#### 14.1.1 Repair and conversion concept

The Endress+Hauser repair and conversion concept provides for the following:

- The measuring devices have a modular design.
- Spare parts are grouped into logical kits with the associated Installation Instructions.
- Repairs are carried out by Endress+Hauser Service or by appropriately trained customers.
- Certified devices can only be converted to other certified devices by Endress+Hauser Service or at the factory.

#### 14.1.2 Notes for repair and conversion

For repair and modification of a measuring device, observe the following notes:

- ▶ Use only original Endress+Hauser spare parts.
- ▶ Carry out the repair according to the Installation Instructions.
- ▶ Observe the applicable standards, federal/national regulations, Ex documentation (XA) and certificates.
- ▶ Document every repair and each conversion and enter them into the *W@M* life cycle management database and Netilion Analytics.

### 14.2 Spare parts

*W@M Device Viewer* ([www.endress.com/deviceviewer](http://www.endress.com/deviceviewer)):

All the spare parts for the measuring device, along with the order code, are listed here and can be ordered. If available, users can also download the associated Installation Instructions.

-  Measuring device serial number:  
Is located on the nameplate of the device.

### 14.3 Endress+Hauser services

Endress+Hauser offers a wide range of services.

-  Your Endress+Hauser Sales Center can provide detailed information on the services.

### 14.4 Return

The requirements for safe device return can vary depending on the device type and national legislation.

1. Refer to the web page for information:  
<http://www.endress.com/support/return-material>  
↳ Select the region.
2. Return the device if repairs or a factory calibration are required, or if the wrong device was ordered or delivered.

## 14.5 Disposal



If required by the Directive 2012/19/EU on waste electrical and electronic equipment (WEEE), the product is marked with the depicted symbol in order to minimize the disposal of WEEE as unsorted municipal waste. Do not dispose of products bearing this marking as unsorted municipal waste. Instead, return them to Endress+Hauser for disposal under the applicable conditions.

### 14.5.1 Removing the measuring device

1. Switch off the device.

#### **⚠ WARNING**

##### **Danger to persons from process conditions!**

- ▶ Beware of hazardous process conditions such as pressure in the measuring device, high temperatures or aggressive media.
2. Carry out the mounting and connection steps from the "Mounting the measuring device" and "Connecting the measuring device" sections in reverse order. Observe the safety instructions.

### 14.5.2 Disposing of the measuring device

#### **⚠ WARNING**

##### **Danger to personnel and environment from fluids that are hazardous to health.**

- ▶ Ensure that the measuring device and all cavities are free of fluid residues that are hazardous to health or the environment, e.g. substances that have permeated into crevices or diffused through plastic.

Observe the following notes during disposal:

- ▶ Observe valid federal/national regulations.
- ▶ Ensure proper separation and reuse of the device components.

## 15 Accessories

Various accessories, which can be ordered with the device or subsequently from Endress+Hauser, are available for the device. Detailed information on the order code in question is available from your local Endress+Hauser sales center or on the product page of the Endress+Hauser website: [www.endress.com](http://www.endress.com).

### 15.1 Device-specific accessories

#### 15.1.1 For the transmitter

Accessories	Description
Transmitter	<b>Transmitter for replacement.</b> The serial number of the current transmitter must be specified when ordering. On the basis of the serial number, device-specific data in the replaced device can also be used in the new transmitter. This also includes software options and analysis parameters that are already available. Order number: DK9BXX
Transmitter holder (pipe mounting)	Transmitter holder for stainless steel housing for mounting on a post. The holder can be ordered directly with the measuring device (order code for "Accessory enclosed") or subsequently with the order number 50062121.
Sensor/transmitter connecting cable	The following cable lengths are available: <ul style="list-style-type: none"> <li>▪ 1 m (3 ft)</li> <li>▪ 2 m (6 ft)</li> <li>▪ 5 m (15 ft)</li> <li>▪ 10 m (30 ft)</li> </ul> The connecting cable can be ordered directly with the measuring device (order code for "Cable, sensor connection") or subsequently with the order number XPD0047.

#### 15.1.2 For the sensor

Accessories	Description
Mounting kit	Mounting kit consisting of: <ul style="list-style-type: none"> <li>▪ 2 process connections</li> <li>▪ 8 screws</li> <li>▪ Seals (optional)</li> </ul> Order number: DK9HXX
Seal set	For the regular replacement of seals for the sensor. Seal set consisting of: 2 seals Order number: DK9HXX

#### 15.1.3 General information

Accessories	Description
Analysis parameters and packages of analysis parameters sorted by application	<b>Concentration app for the integration of new media.</b> The concentration apps, or analysis parameters according to the area of application, are available on the DVD. The available concentration apps and analysis parameters, as well as the associated measuring ranges, are listed in the Applicator → 79. If you require a concentration app that is not already listed in the Applicator, Endress+Hauser requires a sample of the medium to create the concentration app. Endress+Hauser provides the concentration app as a file in lmf format. Every transmitter can use a maximum of 25 concentration apps. Concentration apps are individually tailored to a specific measuring device and can only be used with this particular device. Order number: DK9502

## 15.2 Service-specific accessories

Accessory	Description
Applicator	<p>Software for selecting and sizing Endress+Hauser measuring devices:</p> <ul style="list-style-type: none"> <li>▪ Choice of measuring devices with industrial requirements</li> <li>▪ Overview and selection of concentration apps.</li> <li>▪ Calculation of all the necessary data for identifying the optimum flowmeter: e.g. nominal diameter, pressure loss, flow velocity and accuracy.</li> <li>▪ Graphic illustration of the calculation results</li> <li>▪ Determination of the partial order code, administration, documentation and access to all project-related data and parameters over the entire life cycle of a project.</li> </ul> <p>Applicator is available:</p> <ul style="list-style-type: none"> <li>▪ Via the Internet: <a href="https://portal.endress.com/webapp/applicator">https://portal.endress.com/webapp/applicator</a></li> <li>▪ As a downloadable DVD for local PC installation.</li> </ul>
W@M	<p>W@M Life Cycle Management</p> <p>Improved productivity with information at your fingertips. Data relevant to a plant and its components is generated from the first stages of planning and during the asset's complete life cycle.</p> <p>W@M Life Cycle Management is an open and flexible information platform with online and on-site tools. Instant access for your staff to current, in-depth data shortens your plant's engineering time, speeds up procurement processes and increases plant uptime.</p> <p>Combined with the right services, W@M Life Cycle Management boosts productivity in every phase. For more information, see: <a href="http://www.endress.com/lifecyclemanagement">www.endress.com/lifecyclemanagement</a></p>

## 16 Technical data

### 16.1 Application

The measuring device is intended only for the concentration measurement of liquids.

To ensure that the device remains in proper operating condition for its service life, use the measuring device only for media against which the process-wetted materials are sufficiently resistant.

### 16.2 Function and system design

Measuring principle	Concentration measurement using ultrasonic waves.
Measuring system	For information on the structure of the device, see "Product description" →  11.

### 16.3 Input

Measured variables	<b>Measured variables</b>	
	<ul style="list-style-type: none"> <li>▪ Speed of sound</li> <li>▪ Temperature</li> <li>▪ Dispersion (relative indicator for disturbance)</li> <li>▪ Acoustic density</li> </ul>	
	<b>Analysis parameters available for order</b>	
	<ul style="list-style-type: none"> <li>▪ Concentration</li> <li>▪ Concentration ratio (ratio between two concentrations)</li> <li>▪ Calculated physical density</li> </ul>	
Measuring ranges	<b>Speed of sound</b>	600 to 2 000 m/s
	<b>Temperature</b>	0 to 120 °C (32 to 248 °F)
	<b>Acoustic density</b>	0.7 to 1.5 g/cm <sup>3</sup>
	<b>Analysis parameter</b>	As per the concentration app data sheet

Input signal	<b>Digital input</b>	
	<b>Function</b>	Select analog channel 1 to 4; The digital inputs "0" and "1" can only be connected to the signal ground.
	<b>Version</b>	Open and ground Do not connect external voltage to these terminals.

#### External measured values



To increase the accuracy, the automation system can write a variety of compensation values to the measuring device:

- Operating pressure (Endress+Hauser recommends the use of a pressure measuring device for absolute pressure, e.g. Cerabar M or Cerabar S)
- CO<sub>2</sub> concentration
- Degree of inversion



- Mineralization
- Physical density
- Acid content
- Sugar concentration

The data sheet of the concentration app and the Applicator contain detailed information about compensation options.

 The signal input for the measured values that are read in must be configured with the "Teqwave Viewer" operating tool within a recipe using the recipe generator →  54. If it is not possible to read measured values into the measuring device using external sensors, the values can be saved as constant measured values within a recipe.

*Digital communication*

The measured values are written by the automation system via Modbus TCP.

## 16.4 Output

Output signal

### Ethernet (Modbus protocol)

Physical interface	RJ-45 (8P8C)
--------------------	--------------

### Current output 4 to 20 mA/voltage output 0 to 10 V

Function	Can be configured as a current output or voltage output, as required
Version	Galvanically isolated
Open-circuit voltage	DC 15.5 V
Assignable measured variables	<ul style="list-style-type: none"> <li>▪ Off</li> <li>▪ On</li> <li>▪ Analysis parameter 1...n</li> <li>▪ Temperature</li> <li>▪ Speed of sound</li> <li>▪ Dispersion</li> <li>▪ Acoustic density (optional)</li> <li>▪ Suspend measurement</li> </ul>
Current output	4 to 20 mA
Maximum output value	20 mA
Load	0 to 500 Ω
Resolution	1.5 μA
Voltage output	0 to 10 V
Maximum output value	10 V
Load	> 750 Ω
Resolution	1 mV

### Switch output

Function	Switch output
Version	Relay output, galvanically isolated
Maximum switching capacity	AC 30 V/DC 50 V, 1 A

<b>Switching behavior</b>	<ul style="list-style-type: none"> <li>▪ NC contact</li> <li>▪ NO contact</li> </ul>
<b>Assignable functions</b>	<ul style="list-style-type: none"> <li>▪ Off</li> <li>▪ On</li> <li>▪ Limit value (can be configured as a range or trigger value, as required):                             <ul style="list-style-type: none"> <li>▪ Analysis parameter 1...n</li> <li>▪ Temperature</li> <li>▪ Speed of sound</li> <li>▪ Dispersion</li> <li>▪ Acoustic density</li> </ul> </li> </ul>

Signal on alarm

Breakdown information and failure mode of the outputs are configurable →  52.

**Ethernet (Modbus protocol)**

<b>Status bit</b>	Diagnostics information via status bits
-------------------	---

**Current output 4 to 20 mA / voltage output 0 to 10 V**

<b>Failure mode</b>	The breakdown information to be displayed in the event of a breach of the measuring range (over-range/under-range) can be configured in the <b>Output settings</b> parameter: <ul style="list-style-type: none"> <li>▪ Failure value for measured variable if the "0 V/2 mA exceeding limits" option is selected: 2 mA or 0 V</li> <li>▪ Failure value for measured variable if the "Min/Max exceeding limits" option is selected: 4 to 20 mA or 0 to 10 V</li> </ul>
	The breakdown information to be displayed in the event of a breach of the calibration range (over-range/under-range) can be configured in the <b>View filter</b> parameter: <ul style="list-style-type: none"> <li>▪ Failure value for measured variable if the "Calibration range limits" option is selected: 2 mA or 0 V</li> <li>▪ If the measuring device exceeds or drops below the calibration range for the temperature, a failure value is also displayed for the concentration or analysis parameter if this is active.</li> </ul>
	The breakdown information to be displayed if the process is not stationary (stationarity) can be configured in the <b>View filter</b> parameter: Failure value for the concentration or analysis parameter if the <b>Enable stationarity</b> option is selected: 2 mA or 0 V
	The breakdown information to be displayed if the rate of change exceeds the limit value can be configured in the <b>Change in [measured variable]</b> parameter. If the function is enabled: Failure value for concentration or analysis parameter: 2 mA or 0 V
	In the event of process disturbances (dispersion) above the limit value: Failure value for concentration or analysis parameter: 2 mA or 0 V
	If there is not enough liquid or the sensor is faulty: Failure value for all measured variables: 2 mA or 0 V

**Relay output**

<b>Failure mode</b>	If the temperature measurement range is exceeded or undershot: For the concentration or analysis parameter: the current status is held.
	If the temperature calibration range is exceeded or undershot: For the concentration or analysis parameter: the current status is held.
	The breakdown information to be displayed if the process is not stationary (stationarity) can be configured in the <b>View filter</b> parameter. If the "Enable stationarity" option is selected: For the concentration or analysis parameter: the current status is held.

	The breakdown information to be displayed if the rate of change exceeds the limit value can be configured in the <b>Change in [measured variable]</b> parameter. If the function is enabled: For the concentration or analysis parameter: the current status is held.
	In the event of process disturbances (dispersion) above the limit value: For the concentration or analysis parameter: the current status is held.
	If there is not enough liquid: Measured value for all measured variables with the exception of temperature: 0 switch status as per the setting for the switching threshold or switch point ("Operating Instructions" document, "Configuring the relay output" section).
	If the sensor is faulty: Measured value for all measured variables: 0 switch status as per the setting for the switching threshold or switch point ("Operating Instructions" document, "Configuring the relay output" section).

**Local display (transmitter with touch screen)**

<b>Color encoding</b>	Color field indicates measurement and device error ("Operating Instructions" document, "Diagnostics information on local display and in operating tool" section)
<b>Plain text display</b>	Display alternates between information on the cause and the measured value display

**Local display (transmitter with LED)**

<b>Light emitting diodes (LED)</b>	Status indicated by four light emitting diodes ("Operating Instructions" document, "Diagnostics information for transmitter with LED status indication" section)  The light emitting diodes indicate the following information: <ul style="list-style-type: none"> <li>▪ Supply voltage active</li> <li>▪ Error-free measuring system</li> <li>▪ Device alarm/error has occurred</li> <li>▪ Problem with connection to sensor</li> </ul>
------------------------------------	--

**"Teqwave Viewer" operating tool**

<b>Color encoding</b>	Color field indicates measurement and device error ("Operating Instructions" document, "Diagnostics information on local display and in operating tool" section)
<b>Plain text display</b>	Information on the cause

Galvanic isolation

The current and relay outputs are galvanically isolated from the rest of the system.

Protocol-specific data

<b>Protocol</b>	Modbus Applications Protocol Specification V1.1
<b>Response times</b>	Typically 10 to 50 ms
<b>Device type</b>	Slave
<b>Function codes</b>	<ul style="list-style-type: none"> <li>▪ 0x04: Read Input Registers</li> <li>▪ 0x10: Write Multiple Registers</li> </ul>
<b>Modbus data transmission</b>	Big endian
<b>Data access</b>	Each measured variable can be accessed via Modbus TCP.

**16.5 Power supply**

Terminal assignment

→  24

Supply voltage	<b>Transmitter</b>	DC 24 V ±20%
----------------	--------------------	--------------

 The power unit must be tested to ensure it meets safety requirements (PELV).

Power consumption	<b>Transmitter</b>	4 W
-------------------	--------------------	-----

Current consumption	<b>Transmitter</b> Maximum switch-on current	6 A
---------------------	---	-----

Power supply failure      The configuration and recorded data are retained in the device memory.

Electrical connection      →  24

Potential equalization      →  26

Terminals	<b>Terminal type</b>	Screw terminals
	<b>Conductor cross-section</b>	0.129 to 1.31 mm <sup>2</sup> (16 to 26 AWG)



Cable specification      →  24

## 16.6 Performance characteristics

Maximum measured error	<b>Speed of sound</b>	±2 m/s (±6.56 ft/s)
	<b>Temperature</b>	±0.5 K
	<b>Acoustic density</b>	±0.01 g/cm <sup>3</sup>

Repeatability	<b>Speed of sound</b>	±0.3 m/s (0.98 ft/s)
	<b>Temperature</b>	±0.1 K
	<b>Acoustic density</b>	±0.0015 g/cm <sup>3</sup>

Accuracy      **Concentration measurement accuracy**  
 The measuring device can achieve a concentration accuracy of up to 0.01 % absolute. The accuracy depends on the concentration app. The data sheet for this and the Applicator (→  79) contain detailed accuracy information.

 **Compensation of cross-interference**  
 Depending on the concentration app, various compensation values can be entered or read into the measuring device to compensate for known cross-interference. →  54.

Response time **i Influence of medium temperature**  
 The response time of the temperature measurement depends on the transfer of heat from the liquid to the steel. Activation of the Kalman filter accelerates the response time. An erratic change in the temperature generates a temporary error message. A threshold for displaying the error can be set.

Influence of variations in the medium temperature If the medium temperature changes quickly (>1.5 °C/min (2.7 °F/min)), the measured error can be greater than specified in the "Maximum measured error" section.

Influence of vibrations The measured error can be greater than specified in the "Maximum measured error" section as a result of mechanical, acoustic or electrical vibrations in the 0.8 to 2.0 MHz range. We recommend using a dedicated power unit and not the mains power supply.

Influence of ambient temperature **Current/voltage output**

<b>Temperature coefficient</b>	100 µV/°C (µV/°F) or ±1 µA/°C (µA/°F)
--------------------------------	---------------------------------------

Influence of gas bubbles Gas bubbles and particles are disturbance factors when measuring with ultrasonic waves. The recommended installation positions and the "Dispersion" diagnostic information largely prevent incorrect measurement results caused by gas bubbles or particles.

**i** In the case of media with a high CO<sub>2</sub> content, there is the danger of CO<sub>2</sub> outgassing. To prevent outgassing, the process pressure must be set in such a way that the CO<sub>2</sub> saturation limit is not exceeded at the specific process temperature.

## 16.7 Installation

Installation conditions → 20

## 16.8 Environment

Ambient temperature range → 20

Storage temperature 0 to +60 °C (+32 to +140 °F)

<b>Sensor</b>	Standard: IP67, suitable for Pollution degree 4 With the order code for "Sensor options", option <b>CM</b> : additionally IP69
<b>Transmitter</b>	With the order code for "Transmitter housing", option <b>A</b> , "Brushed aluminum": IP40 With the order code for "Transmitter housing", option <b>B</b> , "Stainless": IP67

Interior cleaning CIP according to EHEDG Doc. 2

### NOTICE

**Large and particularly rapid temperature increases can damage the sensor.**

- Ensure that the immediate temperature increase of the medium does not exceed 55 °C/s (99 °F/s).

Electromagnetic compatibility (EMC)

- As per IEC/EN 61326-1
- Complies with emission limit for industry as per EN 55011 (Class A)

For details, refer to the Declaration of Conformity.

 This unit is not intended for use in residential environments and cannot guarantee adequate protection of the radio reception in such environments.

## 16.9 Process

Medium temperature range

**Sensor**

0 to +120 °C (+32 to +248 °F)

Temperature increase

**Sensor**

Max. 55°C/s (99 °F/s)

### NOTICE

**Large and particularly rapid temperature increases can damage the sensor.**

- ▶ Ensure that the immediate temperature increase of the medium does not exceed 55 °C/s (99 °F/s).

Nominal pressure

**Sensor**

Max. 16 bar (232 psi) at 20 °C (68 °F)

Flow velocity

Max. 10 m/s (32.8 ft/s)

## 16.10 Mechanical construction

Design, dimensions



For the dimensions and installed lengths of the device, see the "Technical Information" document, "Mechanical construction" section

Weight

**Transmitter**

Transmitter with aluminum housing	0.34 kg (0.8 lb)
Transmitter with stainless steel housing	1.47 kg (3.24 lb)

**Sensor**

DN 25 mm (DIN)	Max. 2.42 kg (5.34 lb)
DN 1" (ANSI)	Max. 2.48 kg (5.47 lb)

The weight refers to the weight of a device with flanges. It can be lower than specified depending on the process connection.

## Materials

**Transmitter housing**

*Aluminum transmitter housing, order code for "Transmitter housing", option A*

<b>Housing</b>	Anodized aluminum
<b>Window material</b>	Glass
<b>Terminal connection</b>	Polybuteneterephthalate (PBT)
<b>Ethernet interface</b>	<ul style="list-style-type: none"> <li>▪ Socket: ferrite</li> <li>▪ Contact housing: thermoplastic</li> <li>▪ Contacts: 100 % tin with nickel coating, gold-plated</li> </ul>
<b>Push-pull connection</b>	<ul style="list-style-type: none"> <li>▪ Socket: brass, nickel-plated</li> <li>▪ Contact housing: polyetheretherketone (PEEK)</li> <li>▪ Contacts: brass, gold-plated</li> </ul>

*Stainless steel transmitter housing, order code for "Transmitter housing", option B*

<b>Housing</b>	Stainless steel 1.4301 (304)
<b>Window material</b>	Polycarbonate
<b>Cable glands</b>	Stainless steel 1.4305
<b>Terminal connection</b>	Polybuteneterephthalate (PBT)
<b>Ethernet interface</b>	<ul style="list-style-type: none"> <li>▪ Socket: ferrite</li> <li>▪ Contact housing: thermoplastic</li> <li>▪ Contacts: 100 % tin with nickel coating, gold-plated</li> </ul>
<b>Push-pull connection</b>	<ul style="list-style-type: none"> <li>▪ Socket: brass, nickel-plated</li> <li>▪ Contact housing: polyetheretherketone (PEEK)</li> <li>▪ Contacts: brass, gold-plated</li> </ul>

**Sensor**

Stainless steel, 1.4404 (F316L)

**Connecting cable**

<b>Cable, external material</b>	Polyurethane as per DIN EN 60811-2-1 (oil-resistant, halogen-free)
<b>Push-pull connector (standard)</b>	<ul style="list-style-type: none"> <li>▪ Socket: brass, nickel-plated</li> <li>▪ Contact housing: polyetheretherketone (PEEK)</li> <li>▪ Contacts: brass, nickel, gold</li> </ul>
<b>M12 plug with the order code for "Sensor options", option CM (IP69)</b>	<ul style="list-style-type: none"> <li>▪ Socket: stainless steel</li> <li>▪ Contact housing: polyamide (PA66)</li> <li>▪ Contacts: brass, gold</li> </ul>

**Process connections**

Stainless steel, 1.4404 (F316L)

**Seals**

- EPDM
- FKM
- VMQ (silicone)

Process connections	<p>With aseptic gasket seal:</p> <ul style="list-style-type: none"> <li>■ Welding socket (EN 10357 (DIN 11850), ASME BPE, ODT/SMS, ISO 2037)</li> <li>■ Clamp (ISO 2852, DIN 32676, L14 AM7 – Tri-Clamp)</li> <li>■ Coupling (DIN 11851, DIN 11864-1, SMS 1145)</li> <li>■ Flange DIN 11864-2</li> </ul>
---------------------	--

Surface roughness	<p>All data relate to metallic parts in contact with fluid.  <math>Ra_{max} = 0.76 \mu m</math> (30 <math>\mu in</math>) mechanically polished</p>
-------------------	--

## 16.11 Operability

Local operation	<p><b>Via display module</b></p> <p>Two display modules are available:</p> <ul style="list-style-type: none"> <li>■ Order code for "Display, operation", option A: LED status indication</li> <li>■ Order code for "Display; operation", option B: touch screen</li> </ul> <p> In the case of transmitters in a stainless steel housing, the touch screen can only be operated when the housing is open.</p>
-----------------	---

Supported operating tools	Operation via "Teqwave Viewer" Windows Desktop operating tool.
---------------------------	--

Reliable operation	If the power supply fails, data saved in the device and device configurations are retained.
--------------------	---

Languages	<p>Can be operated in the following languages:</p> <ul style="list-style-type: none"> <li>■ Via local operation (transmitter with touch screen) English, German, French, Spanish, Italian</li> <li>■ Via operating tool English, German, French, Spanish, Italian</li> </ul>
-----------	--

## 16.12 Certificates and approvals

CE mark	<p>The device meets the legal requirements of the applicable EU Directives. These are listed in the corresponding EU Declaration of Conformity along with the standards applied.</p> <p>Endress+Hauser confirms successful testing of the device by affixing to it the CE mark.</p>
---------	---

UKCA marking	<p>The device meets the legal requirements of the applicable UK regulations (Statutory Instruments). These are listed in the UKCA Declaration of Conformity along with the designated standards. By selecting the order option for UKCA marking, Endress+Hauser confirms a successful evaluation and testing of the device by affixing the UKCA mark.</p> <p>Contact address Endress+Hauser UK:          Endress+Hauser Ltd.          Floats Road          Manchester M23 9NF          United Kingdom  <a href="http://www.uk.endress.com">www.uk.endress.com</a></p>
--------------	---



Sanitary compatibility

- 3-A approval 28-06
    - Confirmation by affixing the 3-A logo for measuring devices with the order code for "Additional approval", option LP "3-A".
    - The 3-A approval refers to the sensor.
    - Remote transmitters must be installed in accordance with the 3-A Standard.
    - Accessories (e.g. weather protection cover, wall holder unit) must be installed in accordance with the 3-A Standard.  
Each accessory can be cleaned. Disassembly may be necessary under certain circumstances.
  - EHEDG Type EL Class I
    - The EHEDG approval refers to the sensor.
    - Confirmation by affixing the EHEDG symbol for sensors with the order code for "Additional approval", option LT "EHEDG".
    - To meet the requirements for EHEDG certification, the sensor must be connected with process connections in accordance with the EHEDG position paper entitled "Easy Cleanable Pipe Couplings and Process Connections" ([www.ehedg.org](http://www.ehedg.org)).
  - Food Contact Materials Regulation (EC) 1935/2004
  - FDA: All wetted parts are in conformity with FDA requirements.
  - Seals
    - EPDM is not a suitable seal material for media with a fat content > 8 %.
    - FDA-compliant seals: EPDM, FKM, VMQ.
    - EHEDG-compliant seals: EPDM, FKM.
-  Certificates that are currently valid are available in the Download Area of the Endress+Hauser website:
- [www.endress.com](http://www.endress.com) → Downloads
  - Specify the following details in the search area: Approvals & certificates → Hygienic compatibility

Additional certification

**Tests and certificates**

EN10204-3.1 material certificate, wetted parts

Other standards and guidelines



- EN 60529  
Degrees of protection provided by enclosures (IP code)
- EN 61010-1  
Safety requirements for electrical equipment for measurement, control and laboratory use - general requirements
- IEC/EN 61326-2-3  
Electromagnetic compatibility (EMC requirements)
- RoHS and IEC 63000  
Restriction of hazardous substances in electric and electronic devices.

### 16.13 Application packages

Application packages are available for the device to expand the device functions, depending on user needs. The application packages can be ordered with the device or subsequently from Endress+Hauser. The Endress+Hauser sales organization will provide detailed information on the appropriate order code. The product page of the Endress+Hauser website [www.endress.com](http://www.endress.com) also contains additional information on the order code.

Application package	Description
<b>Viewer with interface for data download</b> Order code for "Application package", option EP	<b>Retrieval and storage of measured data.</b> The application package allows users to retrieve measured data that are saved in the internal device memory. In addition, the measured data can be saved in a text file which can then be imported into a database. (Order number: DK9501)

## 16.14 Accessories

 Overview of accessories available for order →  78

## 16.15 Documentation

 For an overview of the scope of the associated Technical Documentation, refer to the following:

- *W@M Device Viewer* ([www.endress.com/deviceviewer](http://www.endress.com/deviceviewer)): Enter the serial number from the nameplate
- *Endress+Hauser Operations App*: Enter the serial number from the nameplate or scan the matrix code on the nameplate

Standard documentation

Document type	Documentation code
Technical Information	TI01573D
Brief Operating Instructions	KA01501D

# Index

## A

Accessories	78
Accuracy	84
Additional certification	89
Aluminum housing	11
Analysis parameters	80
Application	9, 80
Application packages	59, 89
Approvals	88

## B

Basic safety instructions	9
---------------------------	---

## C

Calibration ranges	
Displaying	46
CE mark	10, 88
Certificates	88
Changing the operating language	61
Check	14
Checklist	
Post-connection check	30
Post-installation check	23
Cleaning	
Exterior cleaning	75
Interior cleaning	75
Cleaning in place (CIP)	85
Closing the housing cover	28
Commissioning	42
Advanced settings	54
Configuring the measuring device	43
Compensation values	80
Configure in the recipe	54
Setting manually	56
Concentration app	
Select	43
Concentration app data sheet	80
Concentration apps	
Management	66
Concentration offset	57
Configuring the local display	61
Connecting cable	24
Connecting cable connection	
Transmitter with aluminum housing	25
Transmitter with stainless steel housing	27
Connecting requirements	24
Connecting the measuring device	
Transmitter with aluminum housing	25
Transmitter with stainless steel housing	26
Connection	
see Electrical connection	
Connection examples	29
Current consumption	84
Current output	29
Current output 4 to 20 mA	81

## D

Date of manufacture	16
Declaration of Conformity	10
Degree of protection	85
Design	
Measuring device	11
Designated use	9
Device description files	39
Device documentation	
Supplementary documentation	8
Device information	73
Device name	15
Sensor	16
Device repair	76
Device-specific accessories	78
Diagnostic information	
Dispersion indicator	72
Teqwave Viewer	70
Transmitter with a touch screen	70
Transmitter with LEDs	69, 71
Dimensions	
see "Technical Information" document	
Disposal	77
Document	
Function	6
Symbols	6
Document function	6
Document information	6
Documentation	90

## E

Electrical connection	
Measuring device	24
Electromagnetic compatibility	86
Endress+Hauser services	
Maintenance	75
Repair	76
Ensuring potential equalization	26, 28
Environment	85
Ambient temperature	20
Establishing a connection	
Teqwave Viewer	34
Ethernet interface	11
Extended order code	
Sensor	16
Transmitter	15
Exterior cleaning	75

## F

Field calibration	57
Field of application	
Residual risks	9
Firmware history	74
Flow velocity	86
Function check	42
Function codes	39

**H**

Hygienic compatibility . . . . . 21

**I**

Incoming acceptance . . . . . 14

Incorrect use . . . . . 9

Inlet runs . . . . . 20

Input . . . . . 80

Inspection

    Connection . . . . . 30

    Installation . . . . . 23

Installation conditions . . . . . 20

    Inlet and outlet runs . . . . . 20

    Mounting location . . . . . 20

Interior cleaning . . . . . 75, 85

**K**

Kalman filter . . . . . 85

**M**

Maintenance tasks . . . . . 75

    Replacing seals . . . . . 75

Materials . . . . . 87

Maximum measured error . . . . . 84

Measured variables . . . . . 80

    Analysis parameters . . . . . 80

Measuring device

    Configuration . . . . . 43

    Conversion . . . . . 76

    Design . . . . . 11

    Disposal . . . . . 77

    Identification . . . . . 14

    Integrating via communication protocol . . . . . 39

    Mounting . . . . . 21

    Mounting the sensor . . . . . 21

        Threaded adapter . . . . . 21

        Welding socket . . . . . 21

    Removing . . . . . 77

    Repairs . . . . . 76

    Resetting to factory setting . . . . . 73

    Switching on . . . . . 42

Measuring principle . . . . . 80

Measuring range . . . . . 80

Measuring system . . . . . 80

Medium temperature range . . . . . 86

Modbus TCP

    Function codes . . . . . 39

    Read access . . . . . 39

    Register addresses . . . . . 39

    Register information . . . . . 39

    Write access . . . . . 39

Mounting . . . . . 20

Mounting location . . . . . 20

Mounting position . . . . . 20

Mounting the transmitter . . . . . 22

**N**

Nameplate

    Sensor . . . . . 16

    Transmitter . . . . . 15

Nominal pressure . . . . . 86

**O**

Opening the housing cover . . . . . 26

Opening the measured data . . . . . 64

Operability . . . . . 88

Operation . . . . . 61

Operation options . . . . . 31

    Local display . . . . . 31

    Operating tool . . . . . 33

    Overview . . . . . 31

Operational safety . . . . . 10

Order code . . . . . 15, 16

Outlet runs . . . . . 20

Output signal . . . . . 81

Output variables . . . . . 81

**P**

Packaging disposal . . . . . 19

Performance characteristics . . . . . 84

Post-connection check (checklist) . . . . . 30

Post-installation check . . . . . 42

Post-installation check (checklist) . . . . . 23

Power consumption . . . . . 84

Power supply failure . . . . . 84

Process conditions . . . . . 86

    Flow velocity . . . . . 86

    Medium temperature . . . . . 86

    Nominal pressure . . . . . 86

    Temperature increase . . . . . 86

Process connections . . . . . 88

Product description . . . . . 11

Product identification . . . . . 14

Product safety . . . . . 10

Push-pull connection . . . . . 11

**R**

Reading measured values

    Local display . . . . . 61

    Operating tool . . . . . 62

Reading the device memory . . . . . 65

Recalibration . . . . . 75

Recipe generator . . . . . 54

Recipes . . . . . 54

    Management . . . . . 66

Registered trademarks . . . . . 8

Repair . . . . . 76

    Notes . . . . . 76

Repair of a device . . . . . 76

Repeatability . . . . . 84

Replacement

    Device components . . . . . 76

Replacing seals . . . . . 75

Requirements for personnel . . . . . 9

Residual risks . . . . . 9

Response time . . . . . 85

Retrieving measured data . . . . . 64

Return . . . . . 76

**S**

Sanitary compatibility . . . . .	89
Saving measured data . . . . .	65
Seals . . . . .	87
Sensor . . . . .	11
Mounting . . . . .	21
Testing . . . . .	72
Serial number . . . . .	15, 16
Setting the operating language . . . . .	42
Settings	
Analog output . . . . .	44
Compensation values (manual) . . . . .	56
Compensation values (recipe) . . . . .	54
Concentration 1...3 . . . . .	54
Concentration offset . . . . .	57
Failsafe mode . . . . .	52
Field calibration . . . . .	57
Local display . . . . .	61
Measured value display . . . . .	49
Measuring range . . . . .	46
Measuring unit . . . . .	43
Operating language . . . . .	42, 61
Recipe generator . . . . .	54
Selecting the concentration app . . . . .	43
Switch output . . . . .	47
Touch screen . . . . .	50
Signal cable connection	
Transmitter with aluminum housing . . . . .	26
Transmitter with stainless steel housing . . . . .	27
Signal on alarm . . . . .	82
Software installation	
Teqwave Viewer . . . . .	34
Spare part . . . . .	76
Spare parts . . . . .	76
Special connection instructions . . . . .	29
Special mounting instructions	
Hygienic compatibility . . . . .	21
Stainless steel housing . . . . .	11
Standards and guidelines . . . . .	89
Storage conditions . . . . .	19
Storage temperature . . . . .	19
Supply unit	
Requirements . . . . .	25
Supply voltage . . . . .	84
Supply voltage cable connection	
Transmitter with aluminum housing . . . . .	26
Transmitter with stainless steel housing . . . . .	27
Surface roughness . . . . .	88
Switch output . . . . .	29, 81
Symbols	
Measuring device . . . . .	17
System design	
Measuring system . . . . .	80
System integration . . . . .	39
Modbus TCP information . . . . .	39
System requirements	
Teqwave Viewer . . . . .	34

**T**

Technical data, overview . . . . .	80
Temperature increase . . . . .	86
Temperature range	
Environment . . . . .	20, 85
Storage . . . . .	85
Storage temperature . . . . .	19
Teqwave Viewer	
Establishing a connection . . . . .	34
Operation options . . . . .	33
Software installation . . . . .	34
System requirements . . . . .	34
Troubleshooting . . . . .	69
User interface . . . . .	36
Terminal assignment . . . . .	24
Terminals . . . . .	84
Tests and certificates . . . . .	89
Transmitter . . . . .	11
Mounting . . . . .	21
Replacement . . . . .	66
Transporting the measuring device . . . . .	19
Troubleshooting	
General . . . . .	68
Local display (transmitter with LEDs) . . . . .	68
Local display (transmitter with touch screen) . . . . .	68
Output signals . . . . .	68
Teqwave Viewer . . . . .	69

**U**

UKCA marking . . . . .	88
Updating the firmware . . . . .	67
Use of the measuring device	
Incorrect use . . . . .	9
see Designated use	
User interface	
Teqwave Viewer . . . . .	36

**V**

Voltage output 0 to 10 V . . . . .	81
------------------------------------	----

**W**

W@M . . . . .	14, 76
W@M Device Viewer . . . . .	76
Weight data . . . . .	86
Workplace safety . . . . .	9







[www.addresses.endress.com](http://www.addresses.endress.com)

---