

Operating Instructions

Proline Promag E 100

Modbus RS485

Electromagnetic flowmeter

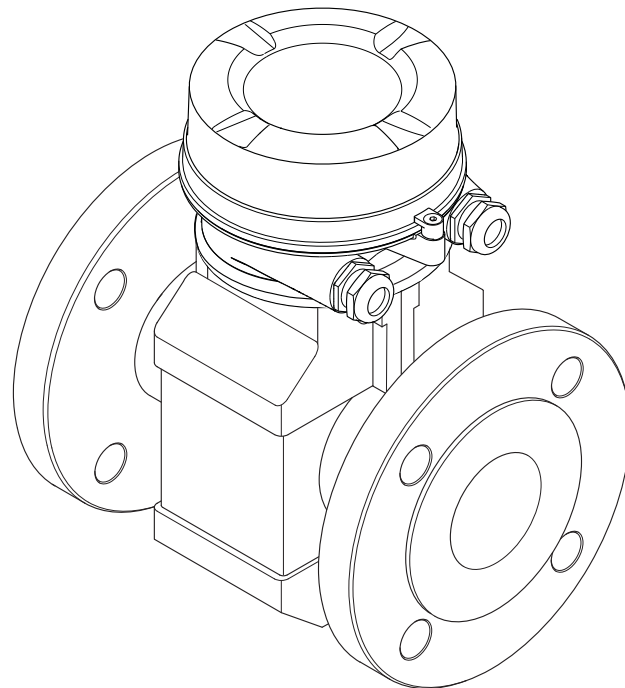

- Make sure the document is stored in a safe place such that it is always available when working on or with the device.
- To avoid danger to individuals or the facility, read the "Basic safety instructions" section carefully, as well as all other safety instructions in the document that are specific to working procedures.
- The manufacturer reserves the right to modify technical data without prior notice. Your Endress+Hauser Sales Center will supply you with current information and updates to these instructions.

Table of contents

1	About this document	5	6.2	Mounting the measuring device	22
1.1	Document function	5	6.2.1	Required tools	22
1.2	Symbols used	5	6.2.2	Preparing the measuring device	22
1.2.1	Safety symbols	5	6.2.3	Mounting the sensor	22
1.2.2	Electrical symbols	5	6.2.4	Turning the display module	27
1.2.3	Tool symbols	5	6.3	Post-installation check	27
1.2.4	Symbols for certain types of information	6	7	Electrical connection	29
1.2.5	Symbols in graphics	6	7.1	Connection conditions	29
1.3	Documentation	6	7.1.1	Required tools	29
1.3.1	Standard documentation	7	7.1.2	Requirements for connecting cable ...	29
1.3.2	Supplementary device-dependent documentation	7	7.1.3	Terminal assignment	30
1.4	Registered trademarks	7	7.1.4	Pin assignment, device plug	31
2	Basic safety instructions	8	7.1.5	Shielding and grounding	31
2.1	Requirements for the personnel	8	7.1.6	Preparing the measuring device	32
2.2	Designated use	8	7.2	Connecting the measuring device	32
2.3	Workplace safety	9	7.2.1	Connecting the transmitter	32
2.4	Operational safety	9	7.2.2	Ensure potential equalization	34
2.5	Product safety	9	7.3	Special connection instructions	36
2.6	IT security	10	7.3.1	Connection examples	36
3	Product description	11	7.4	Ensuring the degree of protection	36
3.1	Product design	11	7.5	Post-connection check	37
3.1.1	Device version with Modbus RS485 communication type	11	8	Operation options	38
4	Incoming acceptance and product identification	12	8.1	Overview of operating options	38
4.1	Incoming acceptance	12	8.2	Structure and function of the operating menu	39
4.2	Product identification	12	8.2.1	Structure of the operating menu	39
4.2.1	Transmitter nameplate	13	8.2.2	Operating philosophy	40
4.2.2	Sensor nameplate	14	8.3	Access to the operating menu via the operating tool	40
4.2.3	Symbols on measuring device	15	8.3.1	Connecting the operating tool	40
5	Storage and transport	16	8.3.2	FieldCare	41
5.1	Storage conditions	16	8.3.3	DeviceCare	43
5.2	Transporting the product	16	9	System integration	44
5.2.1	Measuring devices without lifting lugs	16	9.1	Overview of device description files	44
5.2.2	Measuring devices with lifting lugs ..	17	9.1.1	Current version data for the device ...	44
5.2.3	Transporting with a fork lift	17	9.1.2	Operating tools	44
5.3	Packaging disposal	17	9.2	Modbus RS485 information	44
6	Installation	18	9.2.1	Function codes	44
6.1	Installation conditions	18	9.2.2	Register information	45
6.1.1	Mounting position	18	9.2.3	Response time	46
6.1.2	Requirements from environment and process	20	9.2.4	Modbus data map	46
			10	Commissioning	48
			10.1	Function check	48
			10.2	Connecting via FieldCare	48
			10.3	Setting the operating language	48
			10.4	Configuring the measuring device	48
			10.4.1	Defining the tag name	48
			10.4.2	Setting the system units	49

10.4.3	Configuring the communication interface	50	13	Maintenance	74
10.4.4	Configuring the low flow cut off	51	13.1	Maintenance tasks	74
10.4.5	Configuring empty pipe detection	53	13.1.1	Exterior cleaning	74
10.5	Advanced settings	54	13.1.2	Interior cleaning	74
10.5.1	Carrying out a sensor adjustment	54	13.1.3	Replacing seals	74
10.5.2	Configuring the totalizer	54	13.2	Measuring and test equipment	74
10.5.3	Performing electrode cleaning	55	13.3	Endress+Hauser services	74
10.5.4	Using parameters for device administration	56	14	Repairs	75
10.6	Simulation	57	14.1	General notes	75
10.7	Protecting settings from unauthorized access	57	14.1.1	Repair and conversion concept	75
10.7.1	Write protection via write protection switch	57	14.1.2	Notes for repair and conversion	75
11	Operation	59	14.2	Spare parts	75
11.1	Reading the device locking status	59	14.3	Endress+Hauser services	75
11.2	Reading measured values	59	14.4	Return	75
11.2.1	"Process variables" submenu	59	14.5	Disposal	76
11.2.2	"Totalizer" submenu	60	14.5.1	Removing the measuring device	76
11.3	Adapting the measuring device to the process conditions	61	14.5.2	Disposing of the measuring device	76
11.4	Performing a totalizer reset	61	15	Accessories	77
11.4.1	Function scope of the "Control Totalizer" parameter	62	15.1	Device-specific accessories	77
11.4.2	Function scope of the "Reset all totalizers" parameter	62	15.1.1	For the transmitter	77
12	Diagnostics and troubleshooting	63	15.1.2	For the sensor	77
12.1	General troubleshooting	63	15.2	Communication-specific accessories	77
12.2	Diagnostic information via light emitting diodes	64	15.3	Service-specific accessories	77
12.2.1	Transmitter	64	15.4	System components	78
12.3	Diagnostic information in DeviceCare or FieldCare	64	16	Technical data	79
12.3.1	Diagnostic options	64	16.1	Application	79
12.3.2	Calling up remedy information	65	16.2	Function and system design	79
12.4	Diagnostic information via communication interface	65	16.3	Input	79
12.4.1	Reading out diagnostic information	65	16.4	Output	81
12.4.2	Configuring error response mode	66	16.5	Power supply	83
12.5	Adapting the diagnostic information	66	16.6	Performance characteristics	84
12.5.1	Adapting the diagnostic behavior	66	16.7	Installation	85
12.6	Overview of diagnostic information	66	16.8	Environment	85
12.7	Pending diagnostic events	68	16.9	Process	86
12.8	Diagnostic list	69	16.10	Mechanical construction	88
12.9	Event logbook	69	16.11	Operability	92
12.9.1	Reading the event logbook	69	16.12	Certificates and approvals	93
12.9.2	Filtering the event logbook	70	16.13	Application packages	94
12.9.3	Overview of information events	70	16.14	Accessories	94
12.10	Resetting the measuring device	71	16.15	Supplementary documentation	94
12.10.1	Function scope of the "Device reset" parameter	71	Index	96	
12.11	Device information	71			
12.12	Firmware history	73			





1 About this document

1.1 Document function





These Operating Instructions contain all the information that is required in various phases of the life cycle of the device: from product identification, incoming acceptance and storage, to mounting, connection, operation and commissioning through to troubleshooting, maintenance and disposal.

1.2 Symbols used



1.2.1 Safety symbols

Symbol	Meaning
	DANGER! This symbol alerts you to a dangerous situation. Failure to avoid this situation will result in serious or fatal injury.
	WARNING! This symbol alerts you to a dangerous situation. Failure to avoid this situation can result in serious or fatal injury.
	CAUTION! This symbol alerts you to a dangerous situation. Failure to avoid this situation can result in minor or medium injury.
	NOTE! This symbol contains information on procedures and other facts which do not result in personal injury.













1.2.2 Electrical symbols

Symbol	Meaning
	Direct current
	Alternating current
	Direct current and alternating current
	Ground connection A grounded terminal which, as far as the operator is concerned, is grounded via a grounding system.
	Protective Earth (PE) A terminal which must be connected to ground prior to establishing any other connections. The ground terminals are situated inside and outside the device: <ul style="list-style-type: none"> ▪ Inner ground terminal: Connects the protective earth to the mains supply. ▪ Outer ground terminal: Connects the device to the plant grounding system.



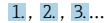

1.2.3 Tool symbols

Symbol	Meaning
	Allen key
	Open-ended wrench

1.2.4 Symbols for certain types of information

Symbol	Meaning
	Permitted Procedures, processes or actions that are permitted.
	Preferred Procedures, processes or actions that are preferred.
	Forbidden Procedures, processes or actions that are forbidden.
	Tip Indicates additional information.
	Reference to documentation.
	Reference to page.
	Reference to graphic.
	Notice or individual step to be observed.
	Series of steps.
	Result of a step.
	Help in the event of a problem.
	Visual inspection.

1.2.5 Symbols in graphics

Symbol	Meaning
1, 2, 3, ...	Item numbers
	Series of steps
A, B, C, ...	Views
A-A, B-B, C-C, ...	Sections
	Hazardous area
	Safe area (non-hazardous area)
	Flow direction

1.3 Documentation

 For an overview of the scope of the associated Technical Documentation, refer to the following:

- The *W@M Device Viewer* : Enter the serial number from the nameplate (www.endress.com/deviceviewer)
- The *Endress+Hauser Operations App*: Enter the serial number from the nameplate or scan the 2-D matrix code (QR code) on the nameplate.

 For a detailed list of the individual documents along with the documentation code

1.3.1 Standard documentation

Document type	Purpose and content of the document
Technical Information	<p>Planning aid for your device</p> <p>The document contains all the technical data on the device and provides an overview of the accessories and other products that can be ordered for the device.</p>
Sensor Brief Operating Instructions	<p>Guides you quickly to the 1st measured value - Part 1</p> <p>The Sensor Brief Operating Instructions are aimed at specialists with responsibility for installing the measuring device.</p> <ul style="list-style-type: none"> ▪ Incoming acceptance and product identification ▪ Storage and transport ▪ Installation
Transmitter Brief Operating Instructions	<p>Guides you quickly to the 1st measured value - Part 2</p> <p>The Transmitter Brief Operating Instructions are aimed at specialists with responsibility for commissioning, configuring and parameterizing the measuring device (until the first measured value).</p> <ul style="list-style-type: none"> ▪ Product description ▪ Installation ▪ Electrical connection ▪ Operation options ▪ System integration ▪ Commissioning ▪ Diagnostic information
Description of Device Parameters	<p>Reference for your parameters</p> <p>The document provides a detailed explanation of each individual parameter in the Expert operating menu. The description is aimed at those who work with the device over the entire life cycle and perform specific configurations.</p> <p>The document provides Modbus-specific information for each individual parameter in the Expert operating menu.</p>

1.3.2 Supplementary device-dependent documentation

Additional documents are supplied depending on the device version ordered: Always comply strictly with the instructions in the supplementary documentation. The supplementary documentation is an integral part of the device documentation.

1.4 Registered trademarks

Modbus®

Registered trademark of SCHNEIDER AUTOMATION, INC.

Microsoft®

Registered trademark of the Microsoft Corporation, Redmond, Washington, USA

2 Basic safety instructions

2.1 Requirements for the personnel

The personnel for installation, commissioning, diagnostics and maintenance must fulfill the following requirements:

- ▶ Trained, qualified specialists must have a relevant qualification for this specific function and task.
- ▶ Are authorized by the plant owner/operator.
- ▶ Are familiar with federal/national regulations.
- ▶ Before starting work, read and understand the instructions in the manual and supplementary documentation as well as the certificates (depending on the application).
- ▶ Follow instructions and comply with basic conditions.

The operating personnel must fulfill the following requirements:

- ▶ Are instructed and authorized according to the requirements of the task by the facility's owner-operator.
- ▶ Follow the instructions in this manual.

2.2 Designated use

Application and media

The measuring device described in these Brief Operating Instructions is intended only for flow measurement of liquids with a minimum conductivity of 5 $\mu\text{S}/\text{cm}$.

Depending on the version ordered, the measuring device can also measure potentially explosive, flammable, poisonous and oxidizing media.

Measuring devices for use in hazardous areas, in hygienic applications or where there is an increased risk due to process pressure, are labeled accordingly on the nameplate.

To ensure that the measuring device remains in proper condition for the operation time:

- ▶ Keep within the specified pressure and temperature range.
- ▶ Only use the measuring device in full compliance with the data on the nameplate and the general conditions listed in the Operating Instructions and supplementary documentation.
- ▶ Based on the nameplate, check whether the ordered device is permitted for the intended use in the hazardous area (e.g. explosion protection, pressure vessel safety).
- ▶ Use the measuring device only for media to which the process-wetted materials are sufficiently resistant.
- ▶ If the measuring device is not operated at atmospheric temperature, compliance with the relevant basic conditions specified in the associated device documentation is absolutely essential: "Documentation" section →  6.
- ▶ Protect the measuring device permanently against corrosion from environmental influences.

Incorrect use

Non-designated use can compromise safety. The manufacturer is not liable for damage caused by improper or non-designated use.

WARNING

Danger of breakage due to corrosive or abrasive fluids!

- ▶ Verify the compatibility of the process fluid with the sensor material.
- ▶ Ensure the resistance of all fluid-wetted materials in the process.
- ▶ Keep within the specified pressure and temperature range.

NOTICE**Verification for borderline cases:**

- ▶ For special fluids and fluids for cleaning, Endress+Hauser is glad to provide assistance in verifying the corrosion resistance of fluid-wetted materials, but does not accept any warranty or liability as minute changes in the temperature, concentration or level of contamination in the process can alter the corrosion resistance properties.

Residual risks**⚠ WARNING**

The electronics and the medium may cause the surfaces to heat up. This presents a burn hazard!

- ▶ For elevated fluid temperatures, ensure protection against contact to prevent burns.

2.3 Workplace safety

For work on and with the device:

- ▶ Wear the required personal protective equipment according to federal/national regulations.

For welding work on the piping:

- ▶ Do not ground the welding unit via the measuring device.

If working on and with the device with wet hands:

- ▶ Due to the increased risk of electric shock, gloves must be worn.

2.4 Operational safety

Risk of injury.

- ▶ Operate the device in proper technical condition and fail-safe condition only.
- ▶ The operator is responsible for interference-free operation of the device.

Conversions to the device

Unauthorized modifications to the device are not permitted and can lead to unforeseeable dangers.

- ▶ If, despite this, modifications are required, consult with Endress+Hauser.

Repair

To ensure continued operational safety and reliability,

- ▶ Carry out repairs on the device only if they are expressly permitted.
- ▶ Observe federal/national regulations pertaining to repair of an electrical device.
- ▶ Use original spare parts and accessories from Endress+Hauser only.

2.5 Product safety

This measuring device is designed in accordance with good engineering practice to meet state-of-the-art safety requirements, has been tested, and left the factory in a condition in which it is safe to operate.

It meets general safety standards and legal requirements. It also complies with the EU directives listed in the device-specific EU Declaration of Conformity. Endress+Hauser confirms this by affixing the CE mark to the device.

2.6 IT security

We only provide a warranty if the device is installed and used as described in the Operating Instructions. The device is equipped with security mechanisms to protect it against any inadvertent changes to the device settings.

IT security measures in line with operators' security standards and designed to provide additional protection for the device and device data transfer must be implemented by the operators themselves.

3 Product description

The device consists of a transmitter and a sensor.

The device is available as a compact version:

The transmitter and sensor form a mechanical unit.

3.1 Product design

3.1.1 Device version with Modbus RS485 communication type

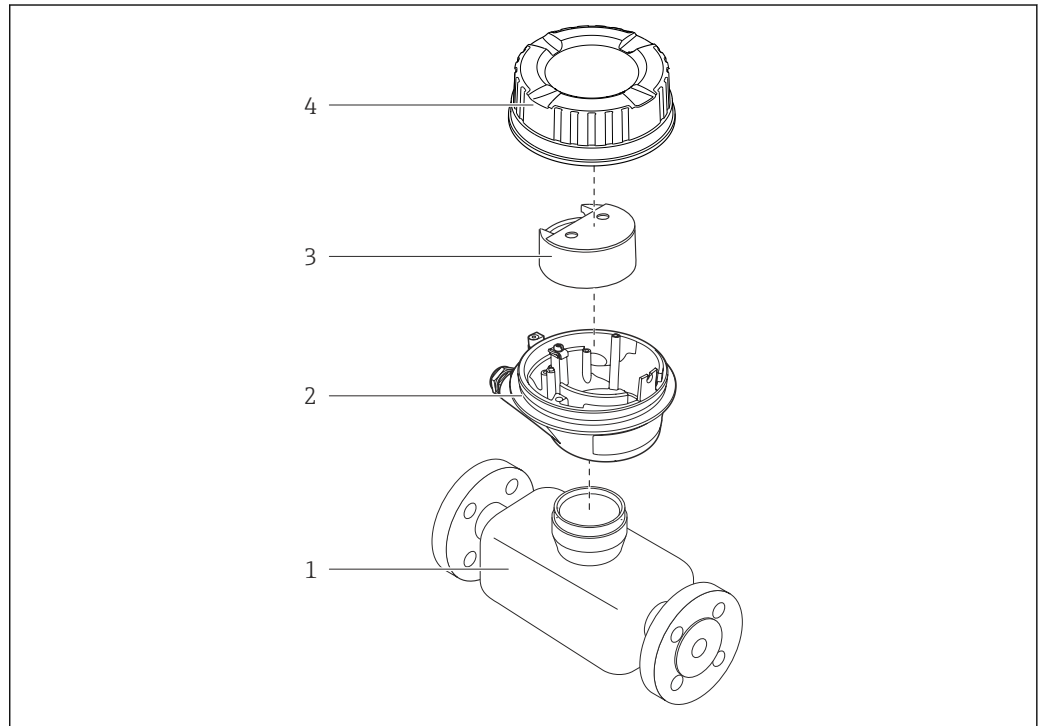

A0017609

 1 Important components of a measuring device

- 1 Sensor
- 2 Transmitter housing
- 3 Main electronics module
- 4 Transmitter housing cover

4 Incoming acceptance and product identification

4.1 Incoming acceptance



A0028673

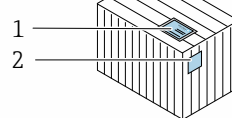
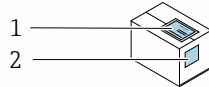

Are the order codes on the delivery note (1) and the product sticker (2) identical?

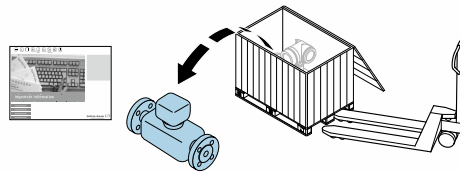

A0028673

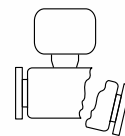
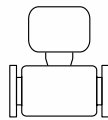

Are the goods undamaged?



A0028673

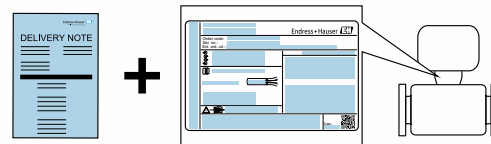

Do the nameplate data match the ordering information on the delivery note?



A0028673

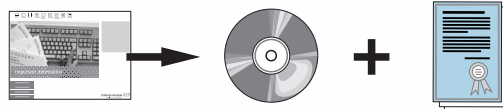

Is the CD-ROM with the Technical Documentation (depends on device version) and documents present?



- i** ■ If one of the conditions is not satisfied, contact your Endress+Hauser Sales Center.
- Depending on the device version, the CD-ROM might not be part of the delivery! The Technical Documentation is available via the Internet or via the *Endress+Hauser Operations App*, see the "Product identification" section → 13.

4.2 Product identification

The following options are available for identification of the measuring device:

- Nameplate specifications
- Order code with breakdown of the device features on the delivery note
- Enter serial numbers from nameplates in *W@M Device Viewer* (www.endress.com/deviceviewer): All information about the measuring device is displayed.
- Enter the serial number from the nameplates into the *Endress+Hauser Operations App* or scan the 2-D matrix code (QR code) on the nameplate with the *Endress+Hauser Operations App*: all the information for the measuring device is displayed.

For an overview of the scope of the associated Technical Documentation, refer to the following:

- The chapters "Additional standard documentation on the device" →  7 and "Supplementary device-dependent documentation" →  7
- The *W@M Device Viewer*: Enter the serial number from the nameplate (www.endress.com/deviceviewer)
- The *Endress+Hauser Operations App*: Enter the serial number from the nameplate or scan the 2-D matrix code (QR code) on the nameplate.

4.2.1 Transmitter nameplate

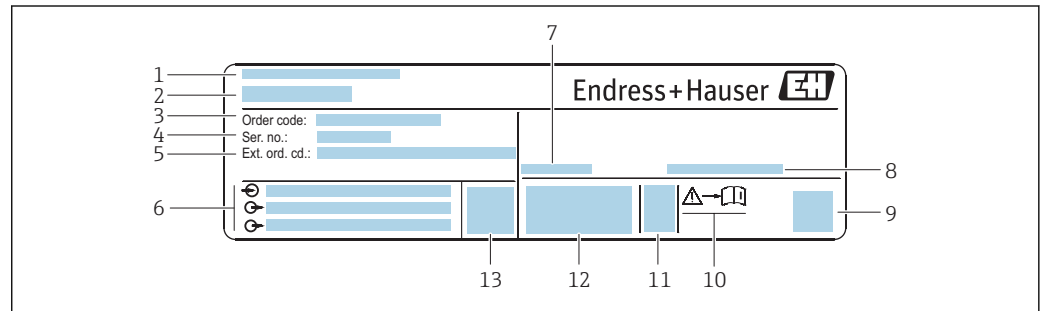

A0030222

 2 Example of a transmitter nameplate

- 1 Manufacturing location
- 2 Name of the transmitter
- 3 Order code
- 4 Serial number (ser. no.)
- 5 Extended order code (Ext. ord. cd.)
- 6 Electrical connection data, e.g. available inputs and outputs, supply voltage
- 7 Permitted ambient temperature (T_a)
- 8 Degree of protection
- 9 2-D matrix code
- 10 Document number of safety-related supplementary documentation
- 11 Manufacturing date: year-month
- 12 CE mark, C-Tick
- 13 Firmware version (FW)

4.2.2 Sensor nameplate

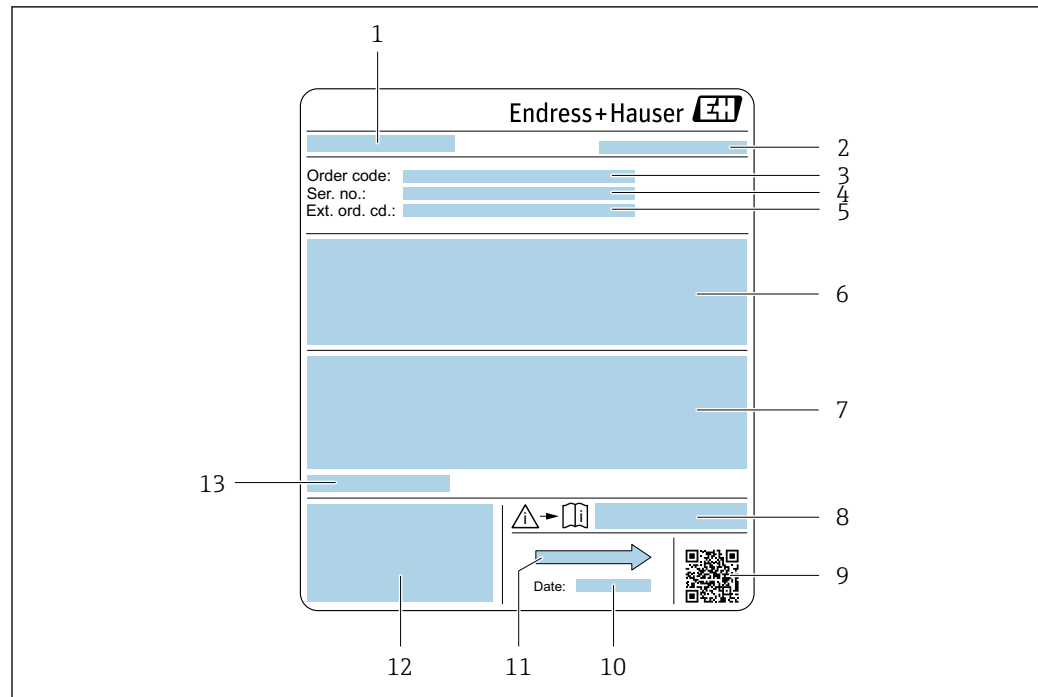

A0029205

 3 Example of sensor nameplate

- 1 Name of the sensor
- 2 Manufacturing location
- 3 Order code
- 4 Serial number (ser. no.)
- 5 Extended order code (Ext. ord. cd.)
- 6 Flow; nominal diameter of the sensor; pressure rating; nominal pressure; system pressure; fluid temperature range; material of liner and electrodes
- 7 Approval information for explosion protection, Pressure Equipment Directive and degree of protection
- 8 Document number of safety-related supplementary documentation →  95
- 9 2-D matrix code
- 10 Manufacturing date: year-month
- 11 Flow direction
- 12 CE mark, C-Tick
- 13 Permitted ambient temperature (T_a)



Order code

The measuring device is reordered using the order code.

Extended order code

- The device type (product root) and basic specifications (mandatory features) are always listed.
- Of the optional specifications (optional features), only the safety and approval-related specifications are listed (e.g. LA). If other optional specifications are also ordered, these are indicated collectively using the # placeholder symbol (e.g. #LA#).
- If the ordered optional specifications do not include any safety and approval-related specifications, they are indicated by the + placeholder symbol (e.g. XXXXXX-ABCDE+).

4.2.3 Symbols on measuring device

Symbol	Meaning
	WARNING! This symbol alerts you to a dangerous situation. Failure to avoid this situation can result in serious or fatal injury.
	Reference to documentation Refers to the corresponding device documentation.
	Protective ground connection A terminal which must be connected to ground prior to establishing any other connections.

5 Storage and transport

5.1 Storage conditions

Observe the following notes for storage:

- ▶ Store in the original packaging to ensure protection from shock.
- ▶ Do not remove protective covers or protective caps installed on process connections. They prevent mechanical damage to the sealing surfaces and contamination in the measuring tube.
- ▶ Protect from direct sunlight to avoid unacceptably high surface temperatures.
- ▶ Select a storage location where moisture cannot collect in the measuring device as fungus and bacteria infestation can damage the lining.
- ▶ Store in a dry and dust-free place.
- ▶ Do not store outdoors.

Storage temperature →  85

5.2 Transporting the product

Transport the measuring device to the measuring point in the original packaging.

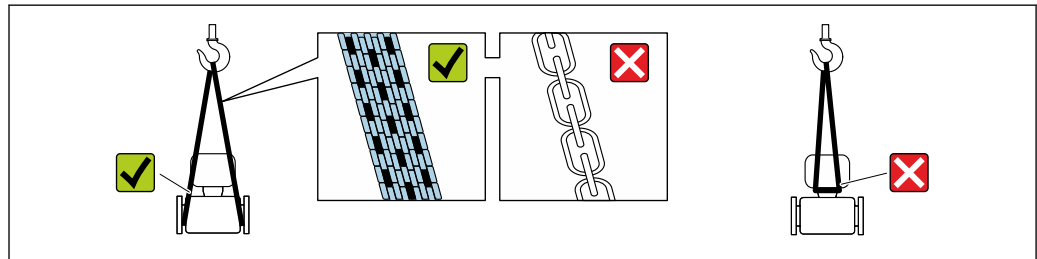

A0029252

 Do not remove protective covers or caps installed on process connections. They prevent mechanical damage to the sealing surfaces and contamination in the measuring tube.

5.2.1 Measuring devices without lifting lugs

WARNING

Center of gravity of the measuring device is higher than the suspension points of the webbing slings.

Risk of injury if the measuring device slips.

- ▶ Secure the measuring device against slipping or turning.
- ▶ Observe the weight specified on the packaging (stick-on label).

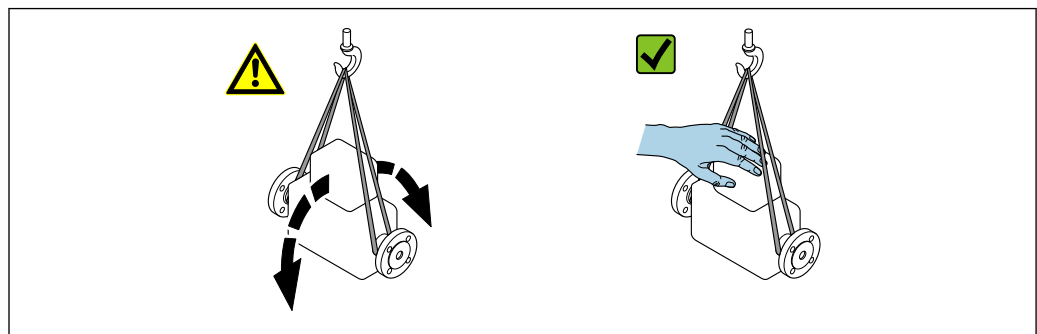

A0029214

5.2.2 Measuring devices with lifting lugs

⚠ CAUTION

Special transportation instructions for devices with lifting lugs

- ▶ Only use the lifting lugs fitted on the device or flanges to transport the device.
- ▶ The device must always be secured at two lifting lugs at least.

5.2.3 Transporting with a fork lift

If transporting in wood crates, the floor structure enables the crates to be lifted lengthwise or at both sides using a forklift.

⚠ CAUTION

Risk of damaging the magnetic coil

- ▶ If transporting by forklift, do not lift the sensor by the metal casing.
- ▶ This would buckle the casing and damage the internal magnetic coils.

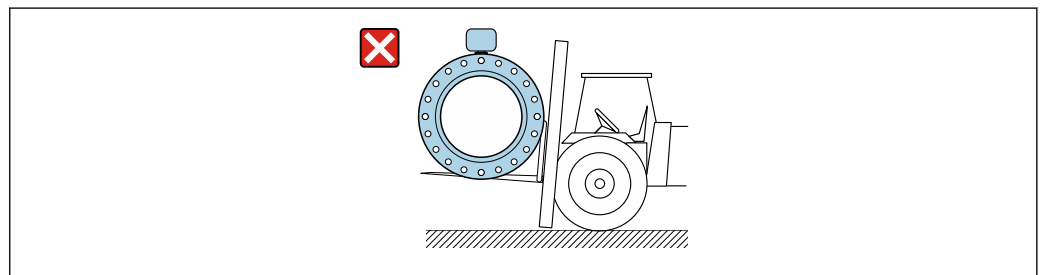

A0029319

5.3 Packaging disposal

All packaging materials are environmentally friendly and 100% recyclable:

- Measuring device secondary packaging: polymer stretch film that conforms to EC Directive 2002/95/EC (RoHS).
- Packaging:
 - Wood crate, treated in accordance with ISPM 15 standard, which is confirmed by the affixed IPPC logo.
 - or
 - Carton in accordance with European Packaging Directive 94/62EC; recyclability is confirmed by the affixed RESY symbol.
- Seaworthy packaging (optional): Wood crate, treated in accordance with ISPM 15 standard, which is confirmed by the affixed IPPC logo.
- Carrying and mounting hardware:
 - Disposable plastic pallet
 - Plastic straps
 - Plastic adhesive strips
- Dunnage: Paper cushion

6 Installation

6.1 Installation conditions

6.1.1 Mounting position

Mounting location

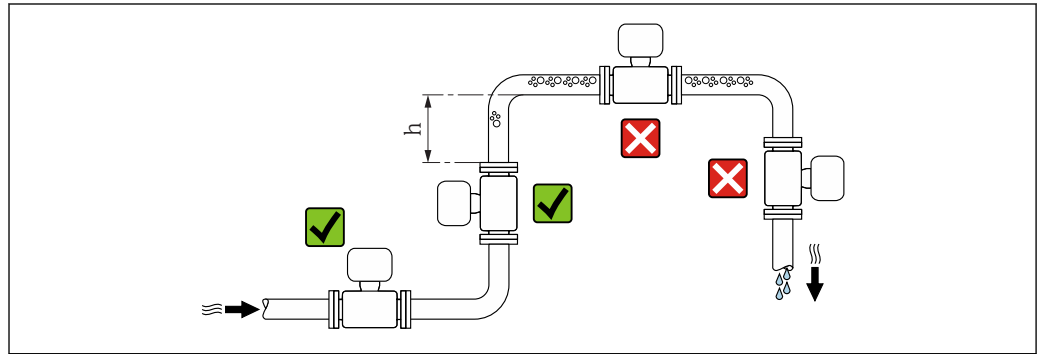

A0029343

Preferably install the sensor in an ascending pipe, and ensure a sufficient distance to the next pipe elbow: $h \geq 2 \times DN$

Installation in down pipes

Install a siphon with a vent valve downstream of the sensor in down pipes whose length $h \geq 5 \text{ m}$ (16.4 ft). This precaution is to avoid low pressure and the consequent risk of damage to the measuring tube. This measure also prevents the system losing prime.

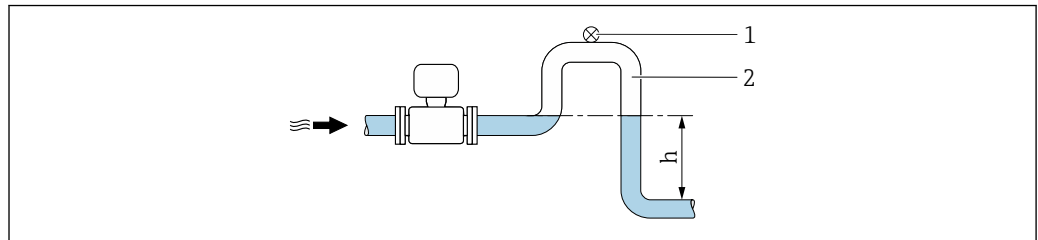

A0028981

4 Installation in a down pipe

- 1 Vent valve
- 2 Pipe siphon
- h Length of down pipe

Installation in partially filled pipes

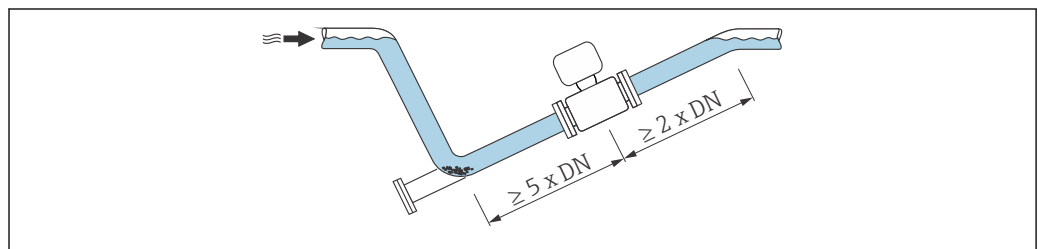

A partially filled pipe with a gradient necessitates a drain-type configuration.



A0029257

Orientation

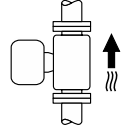
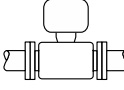
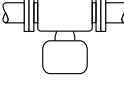
The direction of the arrow on the sensor nameplate helps you to install the sensor according to the flow direction (direction of medium flow through the piping).

Orientation			Recommendation
A	Vertical orientation	 A0015591	☑☑
B	Horizontal orientation, transmitter at top	 A0015589	☑☑ ¹⁾
C	Horizontal orientation, transmitter at bottom	 A0015590	☑☑ ^{2) 3)}
D	Horizontal orientation, transmitter at side	 A0015592	☒

- 1) Applications with low process temperatures may decrease the ambient temperature. To maintain the minimum ambient temperature for the transmitter, this orientation is recommended.
- 2) Applications with high process temperatures may increase the ambient temperature. To maintain the maximum ambient temperature for the transmitter, this orientation is recommended.
- 3) To prevent the electronics module from overheating in the case of a sharp rise in temperature (e.g. CIP- or SIP processes), install the device with the transmitter component pointing downwards.

Horizontal

- Ideally, the measuring electrode plane should be horizontal. This prevents brief insulation of the two measuring electrodes by entrained air bubbles.
- Empty pipe detection only works if the transmitter housing is pointing upwards as otherwise there is no guarantee that the empty pipe detection function will actually respond to a partially filled or empty measuring tube.

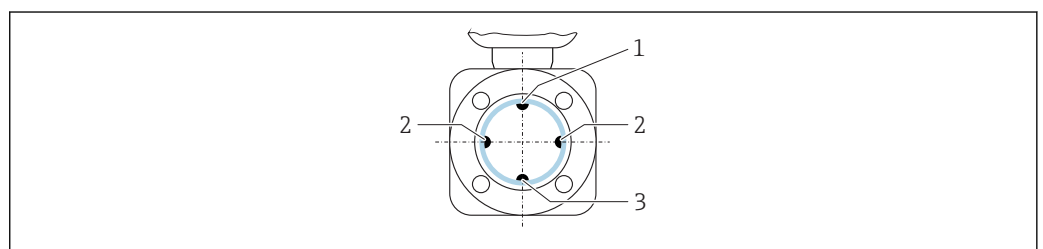

A0029344

- 1 EPD electrode for empty pipe detection
- 2 Measuring electrodes for signal detection
- 3 Reference electrode for potential equalization

Inlet and outlet runs

If possible, install the sensor upstream from fittings such as valves, T-pieces or elbows. Observe the following inlet and outlet runs to comply with accuracy specifications:

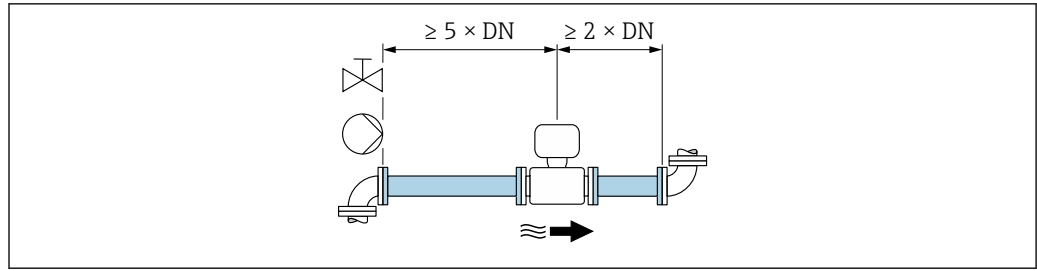

A0028997

- 5 Order code for "Design", option A "Insertion length short, ISO/DVGW until DN400, DN450-2000 1:1" and order code for "Design", option B "Insertion length long, ISO/DVGW until DN400, DN450-2000 1:1.3"

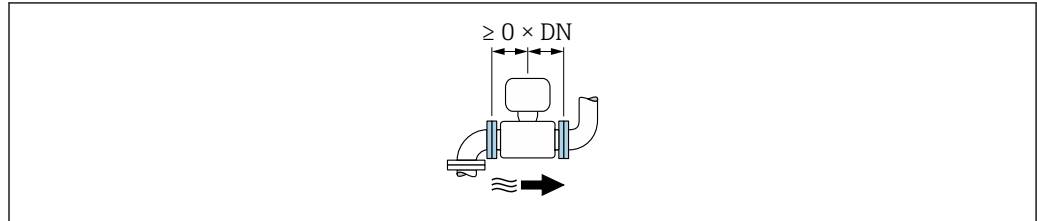

A0032859

- 6 Order code for "Design", option C "Insertion length short ISO/DVGW until DN300, w/o inlet and outlet runs, constricted meas.tube"

Installation dimensions

For the dimensions and installation lengths of the device, see the "Technical Information" document, "Mechanical construction" section.

6.1.2 Requirements from environment and process

Ambient temperature range

Transmitter	-40 to +60 °C (-40 to +140 °F)
Sensor	Process connection material, carbon steel: -10 to +60 °C (+14 to +140 °F)
Liner	Do not exceed or fall below the permitted temperature range of the liner .

If operating outdoors:

- Install the measuring device in a shady location.
- Avoid direct sunlight, particularly in warm climatic regions.
- Avoid direct exposure to weather conditions.

System pressure

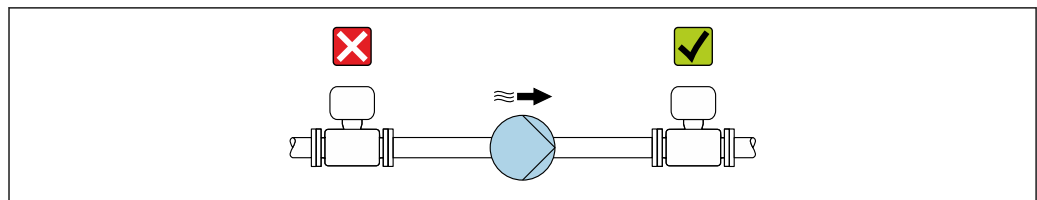

A0028777

Never install the sensor on the pump suction side in order to avoid the risk of low pressure, and thus damage to the liner.

i Furthermore, install pulse dampers if reciprocating, diaphragm or peristaltic pumps are used.

- i** ■ Information on the liner's resistance to partial vacuum → 87
- Information on the shock resistance of the measuring system → 86
- Information on the vibration resistance of the measuring system → 86

Vibrations

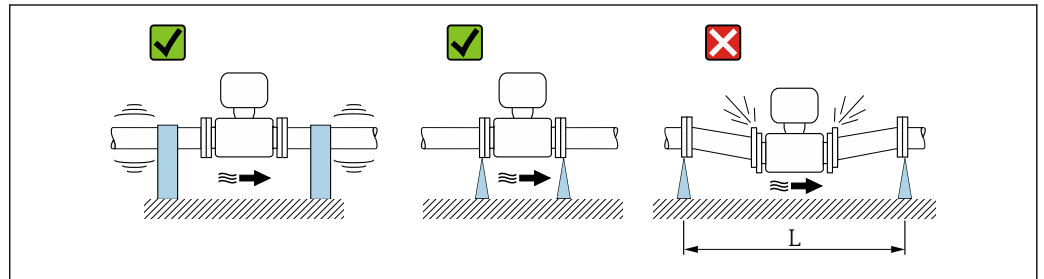

7 Measures to avoid device vibrations ($L > 10\text{ m}$ (33 ft))

In the event of very strong vibrations, the pipe and sensor must be supported and fixed.

- i** ■ Information on the shock resistance of the measuring system → 86
- Information on the vibration resistance of the measuring system → 86

Adapters

Suitable adapters to DIN EN 545 (double-flange reducers) can be used to install the sensor in larger-diameter pipes. The resultant increase in the rate of flow improves measuring accuracy with very slow-moving fluids. The nomogram shown here can be used to calculate the pressure loss caused by reducers and expanders.

i The nomogram only applies to liquids with a viscosity similar to that of water.

1. Calculate the ratio of the diameters d/D .
2. From the nomogram read off the pressure loss as a function of flow velocity (downstream from the reduction) and the d/D ratio.

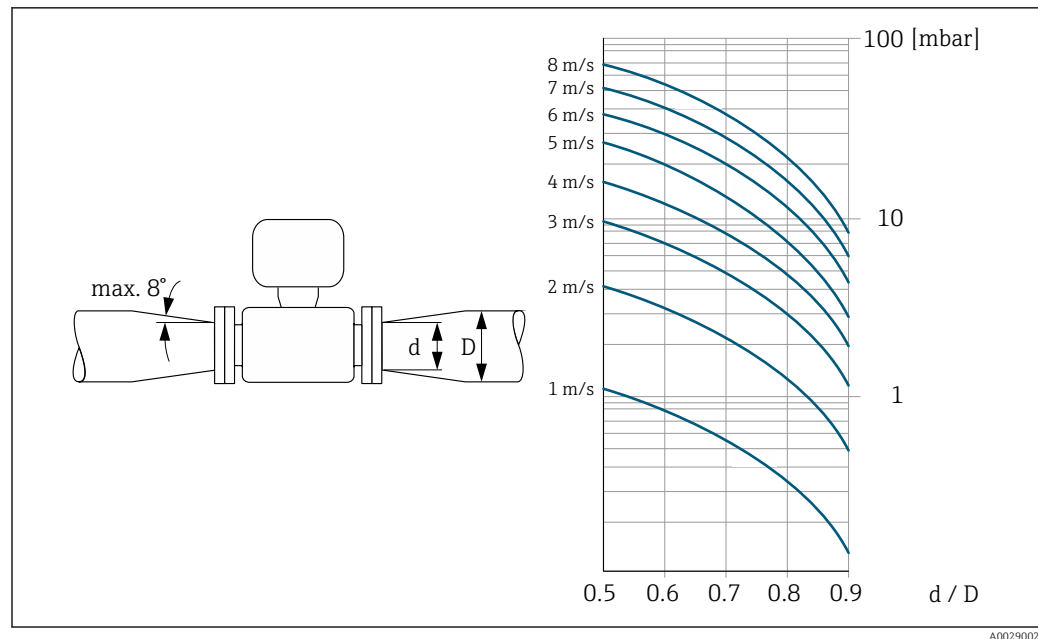

6.2 Mounting the measuring device

6.2.1 Required tools

For sensor

For flanges and other process connections: Corresponding mounting tools

6.2.2 Preparing the measuring device

1. Remove all remaining transport packaging.
2. Remove any protective covers or protective caps present from the sensor.
3. Remove stick-on label on the electronics compartment cover.

6.2.3 Mounting the sensor

⚠ WARNING

Danger due to improper process sealing!

- ▶ Ensure that the inside diameters of the gaskets are greater than or equal to that of the process connections and piping.
 - ▶ Ensure that the gaskets are clean and undamaged.
 - ▶ Install the gaskets correctly.
1. Ensure that the direction of the arrow on the sensor matches the flow direction of the medium.
 2. To ensure compliance with device specifications, install the measuring device between the pipe flanges in a way that it is centered in the measurement section.
 3. If using ground disks, comply with the Installation Instructions provided.
 4. Observe required screw tightening torques → 23.

5. Install the measuring device or turn the transmitter housing so that the cable entries do not point upwards.

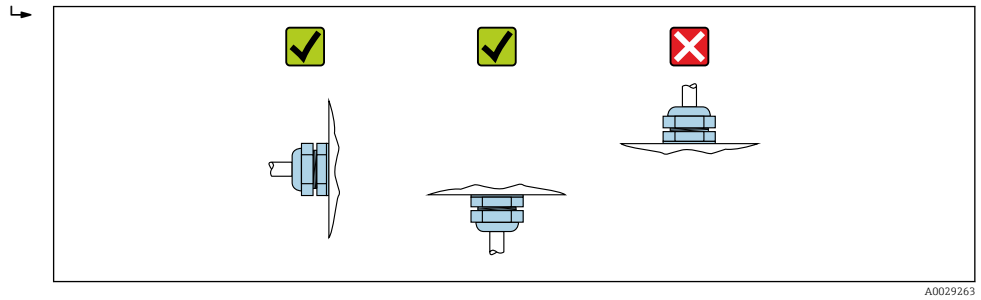

A0029263

Mounting the seals

⚠ CAUTION

An electrically conductive layer could form on the inside of the measuring tube!

Risk of measuring signal short circuit.

- ▶ Do not use electrically conductive sealing compounds such as graphite.

Comply with the following instructions when installing seals:

1. When mounting the process connections, make sure that the seals concerned are clean and centered correctly.
2. For DIN flanges: only use seals according to DIN EN 1514-1.
3. For "PTFE" lining: generally additional seals are **not** required.

Mounting the ground cable/ground disks

Comply with the information on potential equalization and detailed mounting instructions for the use of ground cables/ground disks .

Screw tightening torques

Please note the following:

- The screw tightening torques listed below apply only to lubricated threads and to pipes not subjected to tensile stress.
- Tighten the screws uniformly and in diagonally opposite sequence.
- Overtightening the screws will deform the sealing faces or damage the seals.

Screw tightening torques for EN 1092-1 (DIN 2501), PN 10/16/25/40

Nominal diameter [mm]	Pressure rating [bar]	Screws [mm]	Flange thickness [mm]	Max. screw tightening torque [Nm]	
				PTFE	PFA
15	PN 40	4 × M12	16	11	–
25	PN 40	4 × M12	18	26	20
32	PN 40	4 × M16	18	41	35
40	PN 40	4 × M16	18	52	47
50	PN 40	4 × M16	20	65	59
65 ¹⁾	PN 16	8 × M16	18	43	40
65	PN 40	8 × M16	22	43	40
80	PN 16	8 × M16	20	53	48
80	PN 40	8 × M16	24	53	48
100	PN 16	8 × M16	20	57	51
100	PN 40	8 × M20	24	78	70

Nominal diameter [mm]	Pressure rating [bar]	Screws [mm]	Flange thickness [mm]	Max. screw tightening torque [Nm]	
				PTFE	PFA
125	PN 16	8 × M16	22	75	67
125	PN 40	8 × M24	26	111	99
150	PN 16	8 × M20	22	99	85
150	PN 40	8 × M24	28	136	120
200	PN 10	8 × M20	24	141	101
200	PN 16	12 × M20	24	94	67
200	PN 25	12 × M24	30	138	105
250	PN 10	12 × M20	26	110	-
250	PN 16	12 × M24	26	131	-
250	PN 25	12 × M27	32	200	-
300	PN 10	12 × M20	26	125	-
300	PN 16	12 × M24	28	179	-
300	PN 25	16 × M27	34	204	-
350	PN 10	16 × M20	26	188	-
350	PN 16	16 × M24	30	254	-
350	PN 25	16 × M30	38	380	-
400	PN 10	16 × M24	26	260	-
400	PN 16	16 × M27	32	330	-
400	PN 25	16 × M33	40	488	-
450	PN 10	20 × M24	28	235	-
450	PN 16	20 × M27	40	300	-
450	PN 25	20 × M33	46	385	-
500	PN 10	20 × M24	28	265	-
500	PN 16	20 × M30	34	448	-
500	PN 25	20 × M33	48	533	-
600	PN 10	20 × M27	28	345	-
600 ¹⁾	PN 16	20 × M33	36	658	-
600	PN 25	20 × M36	58	731	-

1) Designed acc. to EN 1092-1 (not to DIN 2501)

Screw tightening torques for EN 1092-1 (DIN 2501), PN 10/16/25, P245GH/stainless; calculated according to EN 1591-1:2014 for flanges as per EN 1092-1:2013

Nominal diameter [mm]	Pressure rating [bar]	Screws [mm]	Flange thickness [mm]	Nom. screw tightening torque [Nm]
				PTFE
350	PN 10	16 × M20	26	60
350	PN 16	16 × M24	30	115
350	PN 25	16 × M30	38	220
400	PN 10	16 × M24	26	90
400	PN 16	16 × M27	32	155
400	PN 25	16 × M33	40	290

Nominal diameter	Pressure rating	Screws	Flange thickness	Nom. screw tightening torque [Nm]
[mm]	[bar]	[mm]	[mm]	PTFE
450	PN 10	20 × M24	28	90
450	PN 16	20 × M27	34	155
450	PN 25	20 × M33	46	290
500	PN 10	20 × M24	28	100
500	PN 16	20 × M30	36	205
500	PN 25	20 × M33	48	345
600	PN 10	20 × M27	30	150
600	PN 16	20 × M33	40	310
600	PN 25	20 × M36	48	500

Screw tightening torques for ASME B16.5, Class 150/300

Nominal diameter		Pressure rating	Screws	Max. screw tightening torque [Nm] ([lbf · ft])	
[mm]	[in]	[psi]	[in]	PTFE	PFA
15	½	Class 150	4 × ½	6 (4)	- (-)
15	½	Class 300	4 × ½	6 (4)	- (-)
25	1	Class 150	4 × ½	11 (8)	10 (7)
25	1	Class 300	4 × 5/8	14 (10)	12 (9)
40	1 ½	Class 150	4 × ½	24 (18)	21 (15)
40	1 ½	Class 300	4 × ¾	34 (25)	31 (23)
50	2	Class 150	4 × 5/8	47 (35)	44 (32)
50	2	Class 300	8 × 5/8	23 (17)	22 (16)
80	3	Class 150	4 × 5/8	79 (58)	67 (49)
80	3	Class 300	8 × ¾	47 (35)	42 (31)
100	4	Class 150	8 × 5/8	56 (41)	50 (37)
100	4	Class 300	8 × ¾	67 (49)	59 (44)
150	6	Class 150	8 × ¾	106 (78)	86 (63)
150	6	Class 300	12 × ¾	73 (54)	67 (49)
200	8	Class 150	8 × ¾	143 (105)	109 (80)
250	10	Class 150	12 × 7/8	135 (100)	- (-)
300	12	Class 150	12 × 7/8	178 (131)	- (-)
350	14	Class 150	12 × 1	260 (192)	- (-)
400	16	Class 150	16 × 1	246 (181)	- (-)
450	18	Class 150	16 × 1 1/8	371 (274)	- (-)
500	20	Class 150	20 × 1 1/8	341 (252)	- (-)
600	24	Class 150	20 × 1 ¼	477 (352)	- (-)

Screw tightening torques for JIS B2220, 10/20K

Nominal diameter [mm]	Pressure rating [bar]	Screws [mm]	Max. screw tightening torque [Nm]	
			PTFE	PFA
25	10K	4 × M16	32	27
25	20K	4 × M16	32	27
32	10K	4 × M16	38	–
32	20K	4 × M16	38	–
40	10K	4 × M16	41	37
40	20K	4 × M16	41	37
50	10K	4 × M16	54	46
50	20K	8 × M16	27	23
65	10K	4 × M16	74	63
65	20K	8 × M16	37	31
80	10K	8 × M16	38	32
80	20K	8 × M20	57	46
100	10K	8 × M16	47	38
100	20K	8 × M20	75	58
125	10K	8 × M20	80	66
125	20K	8 × M22	121	103
150	10K	8 × M20	99	81
150	20K	12 × M22	108	72
200	10K	12 × M20	82	54
200	20K	12 × M22	121	88
250	10K	12 × M22	133	–
250	20K	12 × M24	212	–
300	10K	16 × M22	99	–
300	20K	16 × M24	183	–

Screw tightening torques for JIS B2220, 10/20K

Nominal diameter [mm]	Pressure rating [bar]	Screws [mm]	Nom. screw tightening torque [Nm]	
			PUR	HG
350	10K	16 × M22	109	109
350	20K	16 × M30×3	217	217
400	10K	16 × M24	163	163
400	20K	16 × M30×3	258	258
450	10K	16 × M24	155	155
450	20K	16 × M30×3	272	272
500	10K	16 × M24	183	183
500	20K	16 × M30×3	315	315
600	10K	16 × M30	235	235
600	20K	16 × M36×3	381	381
700	10K	16 × M30	300	300
750	10K	16 × M30	339	339

Screw tightening torques for AS 2129, Table E

Nominal diameter [mm]	Screws [mm]	Max. screw tightening torque [Nm] PTFE
25	4 × M12	21
50	4 × M16	42

Screw tightening torques for AS 4087, PN 16

Nominal diameter [mm]	Screws [mm]	Max. screw tightening torque [Nm] PTFE
50	4 × M16	42

6.2.4 Turning the display module

The local display is only available with the following device version:
Order code for "Display; Operation", option **B**: 4-line; lit, via communication

The display module can be turned to optimize display readability.

Aluminum housing version, AlSi10Mg, coated

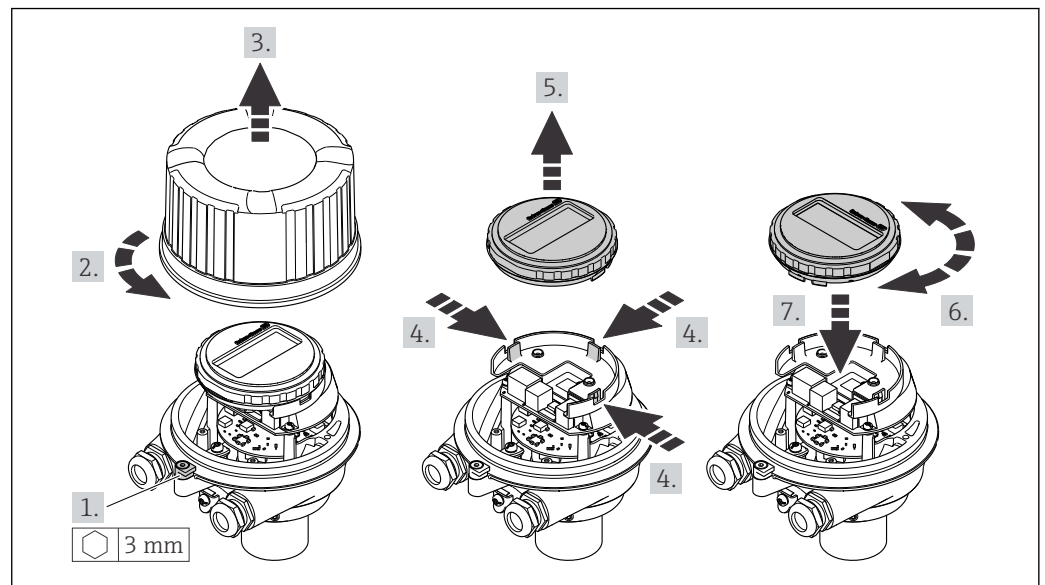

6.3 Post-installation check

Is the device undamaged (visual inspection)?	<input type="checkbox"/>
Does the measuring device conform to the measuring point specifications? For example: <ul style="list-style-type: none"> ▪ Process temperature ▪ Process pressure (refer to the section on "Pressure-temperature ratings" in the "Technical Information" document) ▪ Ambient temperature ▪ Measuring range 	<input type="checkbox"/>

Has the correct orientation for the sensor been selected ? <ul style="list-style-type: none">■ According to sensor type■ According to medium temperature■ According to medium properties (outgassing, with entrained solids)	<input type="checkbox"/>
Does the arrow on the sensor nameplate match the direction of flow of the fluid through the piping ?	<input type="checkbox"/>
Are the measuring point identification and labeling correct (visual inspection)?	<input type="checkbox"/>
Is the device adequately protected from precipitation and direct sunlight?	<input type="checkbox"/>
Have the fixing screws been tightened with the correct tightening torque?	<input type="checkbox"/>

7 Electrical connection

NOTICE

The measuring device does not have an internal circuit breaker.

- ▶ For this reason, assign the measuring device a switch or power-circuit breaker so that the power supply line can be easily disconnected from the mains.
- ▶ Although the measuring device is equipped with a fuse, additional overcurrent protection (maximum 16 A) should be integrated into the system installation.

7.1 Connection conditions

7.1.1 Required tools

- For cable entries: Use corresponding tools
- For securing clamp (on aluminum housing): Allen screw 3 mm
- For securing screw (for stainless steel housing): open-ended wrench 8 mm
- Wire stripper
- When using stranded cables: crimper for wire end ferrule

7.1.2 Requirements for connecting cable

The connecting cables provided by the customer must fulfill the following requirements.

Electrical safety

In accordance with applicable federal/national regulations.

Permitted temperature range

- The installation guidelines that apply in the country of installation must be observed.
- The cables must be suitable for the minimum and maximum temperatures to be expected.

Power supply cable

Standard installation cable is sufficient.

Signal cable

Modbus RS485

The EIA/TIA-485 standard specifies two types of cable (A and B) for the bus line which can be used for every transmission rate. Cable type A is recommended.

Cable type	A
Characteristic impedance	135 to 165 Ω at a measuring frequency of 3 to 20 MHz
Cable capacitance	< 30 pF/m
Wire cross-section	> 0.34 mm ² (22 AWG)
Cable type	Twisted pairs
Loop resistance	\leq 110 Ω /km
Signal damping	Max. 9 dB over the entire length of the cable cross-section
Shield	Copper braided shielding or braided shielding with foil shield. When grounding the cable shield, observe the grounding concept of the plant.

Cable diameter

- Cable glands supplied:
M20 × 1.5 with cable \varnothing 6 to 12 mm (0.24 to 0.47 in)
- Spring terminals:
Wire cross-sections 0.5 to 2.5 mm² (20 to 14 AWG)



7.1.3 Terminal assignment

Transmitter

Modbus RS485 connection version

Order code for "Output", option **M**

Depending on the housing version, the transmitters can be ordered with terminals or device plugs.

Order code "Housing"	Connection methods available		Possible options for order code "Electrical connection"
	Output	Power supply	
Option A	Terminals	Terminals	<ul style="list-style-type: none"> ■ Option A: coupling M20x1 ■ Option B: thread M20x1 ■ Option C: thread G ½" ■ Option D: thread NPT ½"
Option A	Device plugs →  31	Terminals	<ul style="list-style-type: none"> ■ Option L: plug M12x1 + thread NPT ½" ■ Option N: plug M12x1 + coupling M20 ■ Option P: plug M12x1 + thread G ½" ■ Option U: plug M12x1 + thread M20
Option A	Device plugs →  31	Device plugs →  31	Option Q: 2 x plug M12x1
Order code for "Housing": Option A: compact, coated aluminum			

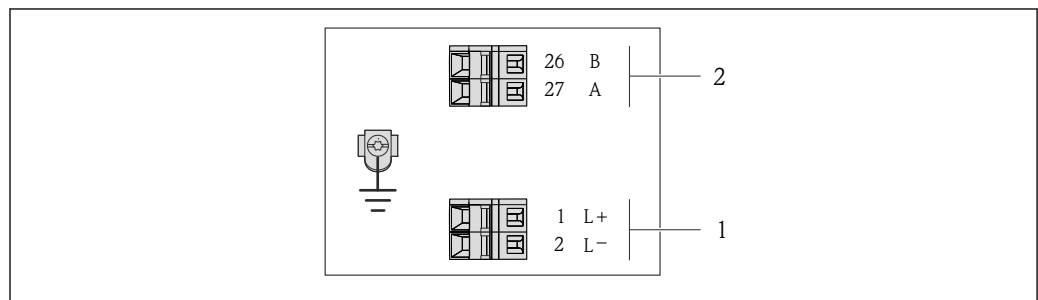

A0019528

 8 Modbus RS485 terminal assignment

- 1 Power supply: DC 24 V
- 2 Modbus RS485

Order code "Output"	Terminal number			
	Power supply		Output	
	1 (L+)	2 (L-)	26 (B)	27 (A)
Option M	DC 24 V		Modbus RS485	
Order code for "Output": Option M : Modbus RS485				

7.1.4 Pin assignment, device plug

Supply voltage

Promag 100

Device plug for supply voltage (device side)

<p>A0016809</p>	Pin		Assignment
	1	L+	DC 24 V
	2		Not assigned
	3		Not assigned
	4	L-	DC 24 V
	5		Grounding/shielding
Coding		Plug/socket	
A		Plug	

Signal transmission

Promag 100

Device plug for signal transmission (device side)

<p>A0016811</p>	Pin		Assignment
	1		Not assigned
	2	A	Modbus RS485
	3		Not assigned
	4	B	Modbus RS485
	5		Grounding/shielding
Coding		Plug/socket	
B		Socket	

7.1.5 Shielding and grounding

Shielding and grounding concept

1. Maintain electromagnetic compatibility (EMC).
2. Take explosion protection into consideration.
3. Pay attention to the protection of persons.
4. Comply with national installation regulations and guidelines.
5. Observe cable specifications .
6. Keep the stripped and twisted lengths of cable shield to the ground terminal as short as possible.
7. Shield cables fully.

Grounding of the cable shield

NOTICE

In systems without potential matching, the multiple grounding of the cable shield causes mains frequency equalizing currents!

Damage to the bus cable shield.

- ▶ Only ground the bus cable shield to either the local ground or the protective ground at one end.
- ▶ Insulate the shield that is not connected.

To comply with EMC requirements:

1. Ensure the cable shield is grounded to the potential matching line at multiple points.
2. Connect every local ground terminal to the potential matching line.

7.1.6 Preparing the measuring device

NOTICE

Insufficient sealing of the housing!

Operational reliability of the measuring device could be compromised.

- ▶ Use suitable cable glands corresponding to the degree of protection.

1. Remove dummy plug if present.
2. If the measuring device is supplied without cable glands:
Provide suitable cable gland for corresponding connecting cable.
3. If the measuring device is supplied with cable glands:
Observe requirements for connecting cables →  29.

7.2 Connecting the measuring device

NOTICE

Limitation of electrical safety due to incorrect connection!

- ▶ Have electrical connection work carried out by appropriately trained specialists only.
- ▶ Observe applicable federal/national installation codes and regulations.
- ▶ Comply with local workplace safety regulations.
- ▶ Always connect the protective ground cable  before connecting additional cables.
- ▶ For use in potentially explosive atmospheres, observe the information in the device-specific Ex documentation.
- ▶ The power unit must be tested to ensure it meets safety requirements (e.g. PELV, SELV).

7.2.1 Connecting the transmitter

The connection of the transmitter depends on the following order codes:

- Housing version: compact or ultra-compact
- Connection version: device plug or terminals

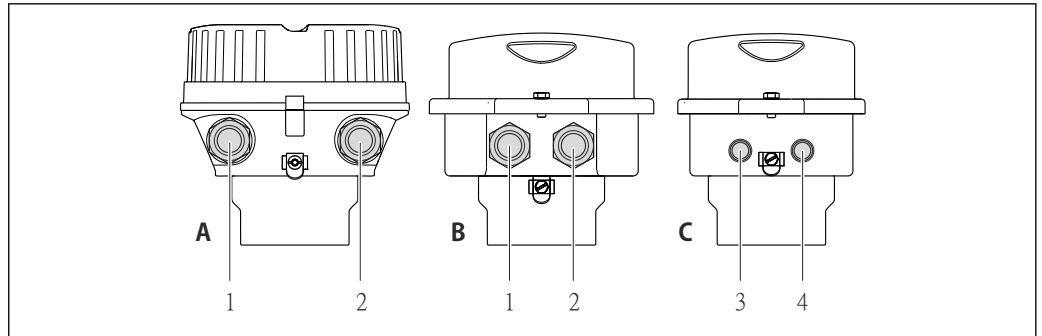

A0016924

9 Housing versions and connection versions

- A Compact, coated aluminum
- B Compact hygienic, stainless or compact, stainless
- 1 Cable entry or device plug for signal transmission
- 2 Cable entry or device plug for supply voltage
- C Ultra-compact hygienic, stainless or ultra-compact, stainless
- 3 Device plug for signal transmission
- 4 Device plug for supply voltage

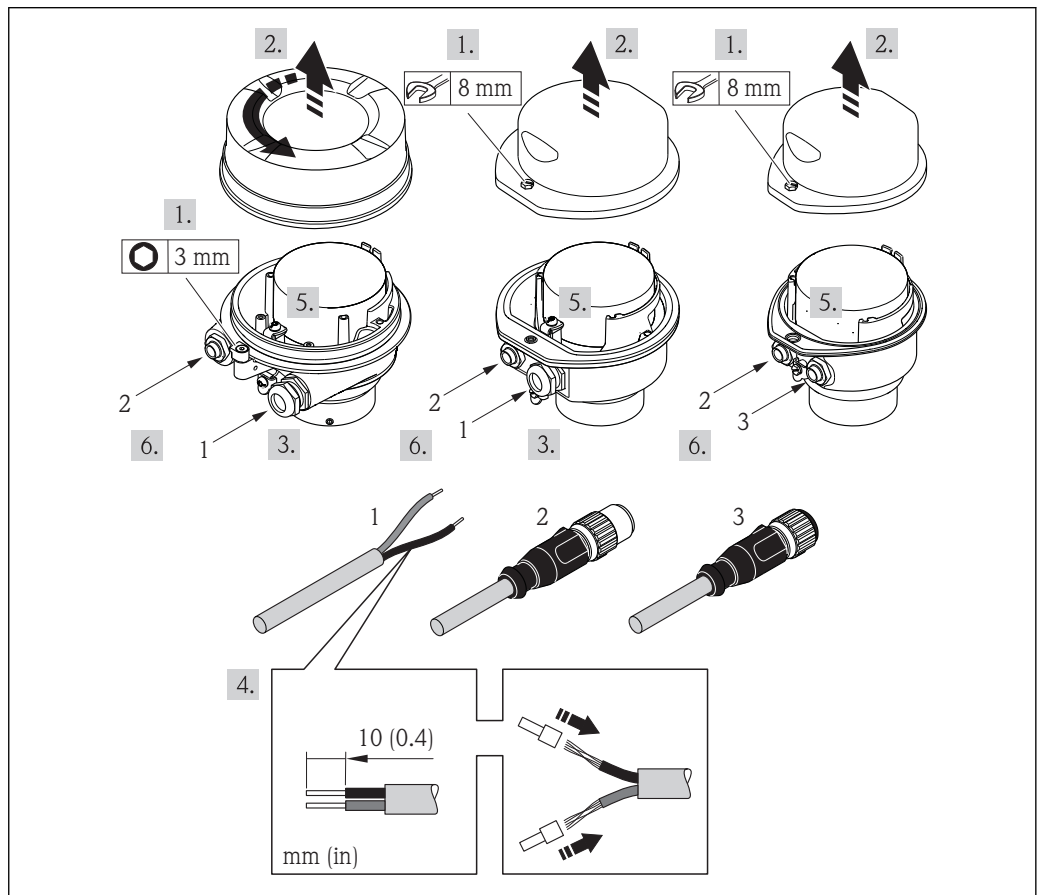

A0017844

10 Device versions with connection examples

- 1 Cable
- 2 Device plug for signal transmission
- 3 Device plug for supply voltage

► Connect the cable in accordance with the terminal assignment or the device plug pin assignment .

7.2.2 Ensure potential equalization

Requirements

⚠ CAUTION

Electrode damage can result in the complete failure of the device!

- ▶ Same electrical potential for the medium and sensor
- ▶ Company-internal grounding concepts
- ▶ Pipe material and grounding

 For devices intended for use in hazardous locations, please observe the guidelines in the Ex documentation (XA).

Connection example, standard scenario

Metal, grounded pipe

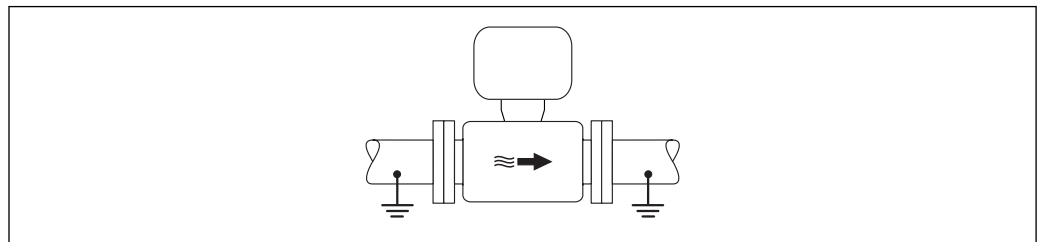

 11 Potential equalization via measuring tube

Connection example in special situations

Unlined and ungrounded metal pipe

This connection method also applies in situations where:

- The customary potential equalization is not used
- Equalizing currents are present

Ground cable	Copper wire, at least 6 mm ² (0.0093 in ²)
---------------------	---

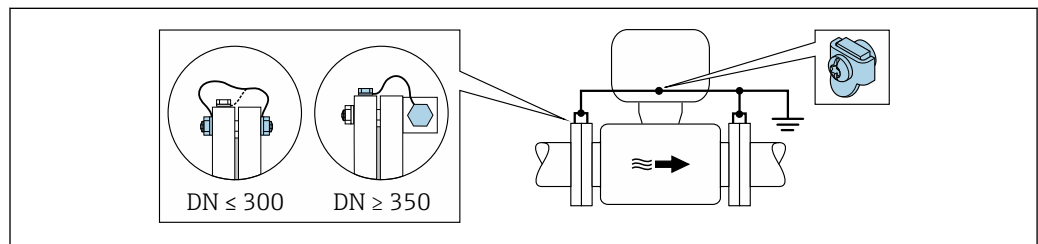

 12 Potential equalization via ground terminal and pipe flanges

1. Connect both sensor flanges to the pipe flange via a ground cable and ground them.
2. If DN ≤ 300 (12"): Mount the ground cable directly on the conductive flange coating of the sensor with the flange screws.
3. If DN ≥ 350 (14"): Mount the ground cable directly on the metal transport bracket. Observe screw tightening torques: see the Sensor Brief Operating Instructions.
4. Connect the connection housing of the transmitter or sensor to ground potential by means of the ground terminal provided for the purpose.

Plastic pipe or pipe with insulating liner

This connection method also applies in situations where:

- The customary potential equalization is not used
- Equalizing currents are present

Ground cable	Copper wire, at least 6 mm ² (0.0093 in ²)
---------------------	---

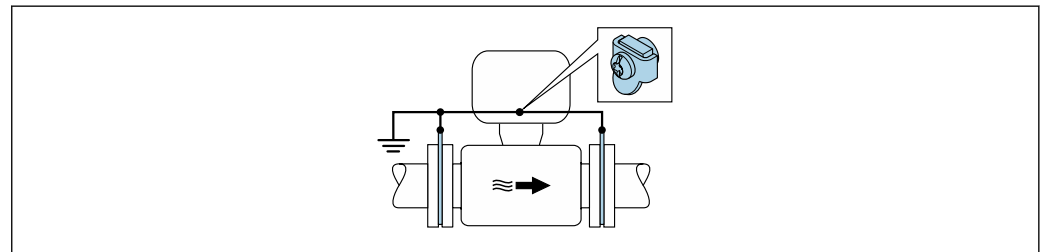

A0029339

13 Potential equalization via ground terminal and ground disks

1. Connect the ground disks to the ground terminal via the ground cable.
2. Connect the ground disks to ground potential.

Pipe with a cathodic protection unit

This connection method is only used if the following two conditions are met:

- Metal pipe without liner or pipe with electrically conductive liner
- Cathodic protection is integrated in the personal protection equipment

Ground cable	Copper wire, at least 6 mm ² (0.0093 in ²)
---------------------	---

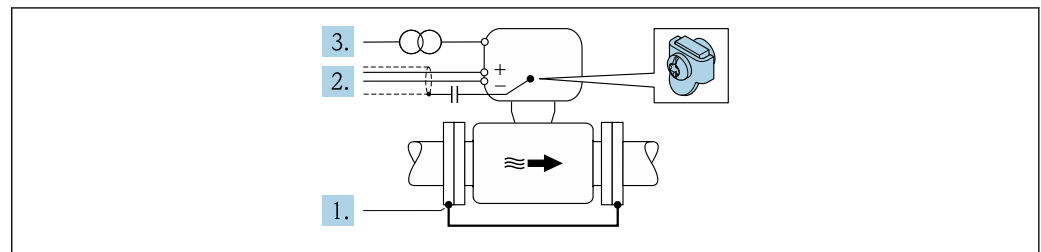

A0029340

Prerequisite: The sensor is installed in the pipe in a way that provides electrical insulation.

1. Connect the two flanges of the pipe to one another via a ground cable.
2. Guide the shield of the signal lines through a capacitor.
3. Connect the measuring device to the power supply such that it is floating in relation to the protective ground (isolation transformer).

7.3 Special connection instructions

7.3.1 Connection examples

Modbus RS485

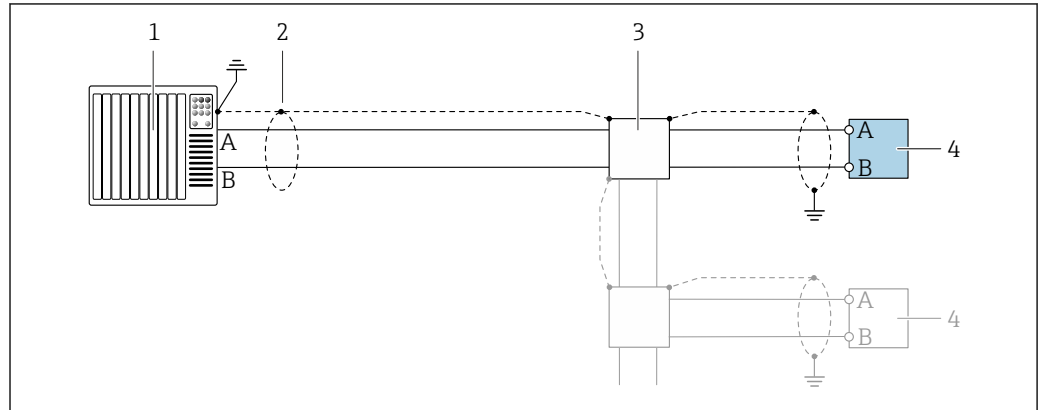

A0028765

14 Connection example for Modbus RS485, non-hazardous area and Zone 2/Div. 2

- 1 Control system (e.g. PLC)
- 2 Cable shield: the cable shield must be grounded at both ends to comply with EMC requirements; observe cable specifications
- 3 Distribution box
- 4 Transmitter

7.4 Ensuring the degree of protection

The measuring device fulfills all the requirements for the IP66/67 degree of protection, Type 4X enclosure.

To guarantee IP66/67 degree of protection, Type 4X enclosure, carry out the following steps after the electrical connection:



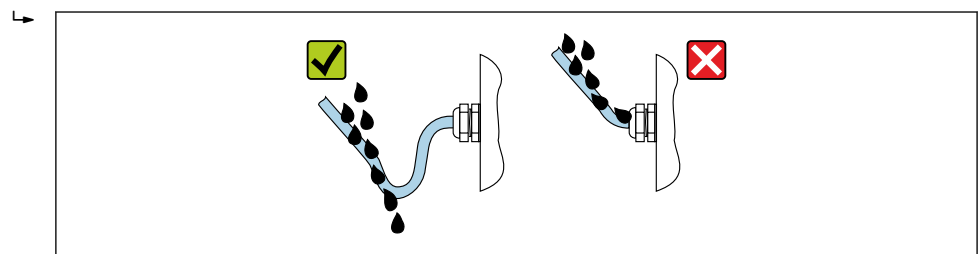





1. Check that the housing seals are clean and fitted correctly.
2. Dry, clean or replace the seals if necessary.
3. Tighten all housing screws and screw covers.
4. Firmly tighten the cable glands.
5. To ensure that moisture does not enter the cable entry:
Route the cable so that it loops down before the cable entry ("water trap").



A0029278

6. Insert dummy plugs into unused cable entries.

7.5 Post-connection check

Are cables or the device undamaged (visual inspection)?	<input type="checkbox"/>
Do the cables used meet the requirements →  29?	<input type="checkbox"/>
Do the cables have adequate strain relief?	<input type="checkbox"/>
Are all the cable glands installed, firmly tightened and leak-tight? Cable run with "water trap" →  36 ?	<input type="checkbox"/>
Depending on the device version: are all the device plugs firmly tightened ?	<input type="checkbox"/>
<ul style="list-style-type: none"> ▪ Does the supply voltage match the specifications on the transmitter nameplate →  83? ▪ For device version with Modbus RS485 intrinsically safe: does the supply voltage match the specifications on the nameplate of the Safety Barrier Promass 100 →  83? 	<input type="checkbox"/>
Is the terminal assignment →  30 or pin assignment of the connector →  31 correct?	<input type="checkbox"/>
<ul style="list-style-type: none"> ▪ If supply voltage is present, is the power LED on the electronics module of the transmitter lit green →  11? ▪ For device version with Modbus RS485 intrinsically safe, if supply voltage is present, is the power LED on the Safety Barrier Promass 100 lit →  11? 	<input type="checkbox"/>
Is the potential equalization established correctly ?	<input type="checkbox"/>
Depending on the device version, is the securing clamp or fixing screw firmly tightened?	<input type="checkbox"/>

8 Operation options

8.1 Overview of operating options

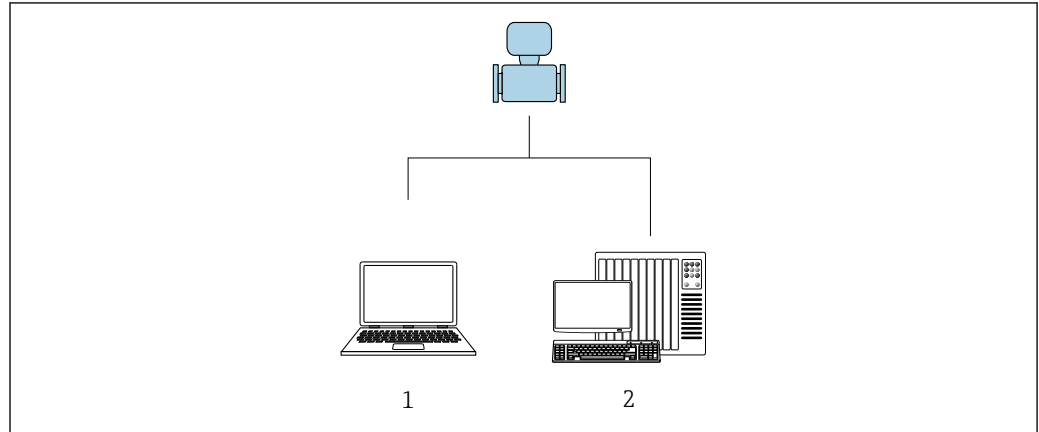

A0017760

- 1 Computer with "FieldCare" or "DeviceCare" operating tool via Commubox FXA291 and service interface
- 2 Control system (e.g. PLC)

8.2 Structure and function of the operating menu

8.2.1 Structure of the operating menu

 For an overview of the operating menu for experts: "Description of Device Parameters" document supplied with the device

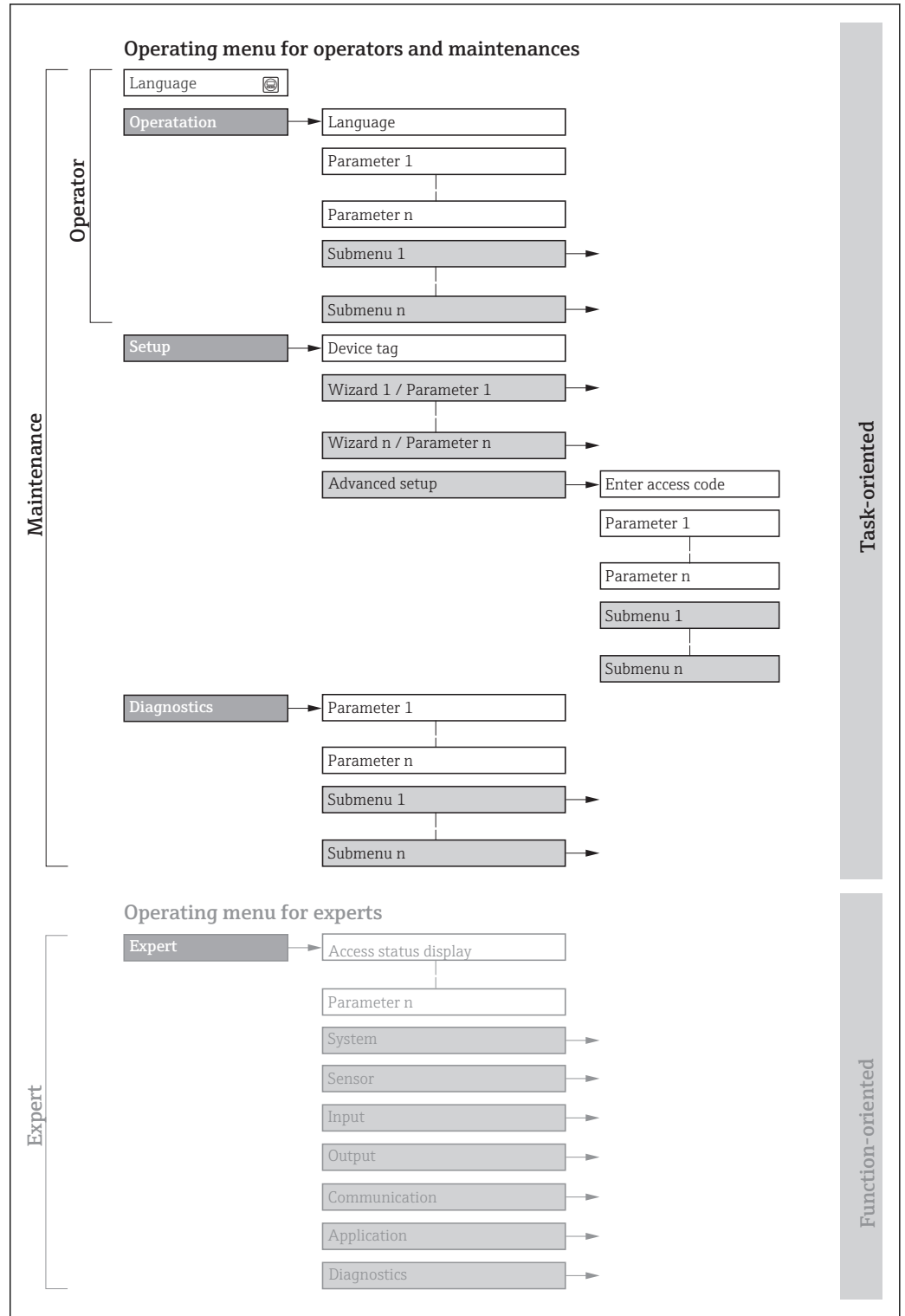

 15 Schematic structure of the operating menu

A0018237-EN

8.2.2 Operating philosophy

The individual parts of the operating menu are assigned to certain user roles (operator, maintenance etc.). Each user role contains typical tasks within the device lifecycle.

Menu/parameter		User role and tasks	Content/meaning
Language	task-oriented	Role "Operator", "Maintenance" Tasks during operation: Reading measured values	<ul style="list-style-type: none"> ▪ Defining the operating language ▪ Resetting and controlling totalizers
Operation			Resetting and controlling totalizers
Setup		"Maintenance" role Commissioning: <ul style="list-style-type: none"> ▪ Configuration of the measurement ▪ Configuration of the communication interface 	Submenus for fast commissioning: <ul style="list-style-type: none"> ▪ Set the system units ▪ Configuration of the digital communication interface ▪ Configuring the operational display ▪ Set the low flow cut off ▪ Empty pipe detection Advanced setup <ul style="list-style-type: none"> ▪ For more customized configuration of the measurement (adaptation to special measuring conditions) ▪ Configuration of totalizers ▪ Configuration of electrode cleaning (optional) ▪ Configure the WLAN settings ▪ Administration (define access code, reset measuring device)
Diagnostics	"Maintenance" role Fault elimination: <ul style="list-style-type: none"> ▪ Diagnostics and elimination of process and device errors ▪ Measured value simulation 	Contains all parameters for error detection and analyzing process and device errors: <ul style="list-style-type: none"> ▪ Diagnostic list Contains up to 5 currently pending diagnostic messages. ▪ Event logbook Contains event messages that have occurred. ▪ Device information Contains information for identifying the device. ▪ Measured values Contains all current measured values. ▪ Heartbeat The functionality of the device is checked on demand and the verification results are documented. ▪ Simulation Is used to simulate measured values or output values. 	
Expert	function-oriented	Tasks that require detailed knowledge of the function of the device: <ul style="list-style-type: none"> ▪ Commissioning measurements under difficult conditions ▪ Optimal adaptation of the measurement to difficult conditions ▪ Detailed configuration of the communication interface ▪ Error diagnostics in difficult cases 	Contains all the parameters of the device and makes it possible to access these parameters directly using an access code. The structure of this menu is based on the function blocks of the device: <ul style="list-style-type: none"> ▪ System Contains all higher-order device parameters which do not concern the measurement or the communication interface. ▪ Sensor Configuration of the measurement. ▪ Communication Configuration of the digital communication interface. ▪ Application Configure the functions that go beyond the actual measurement (e.g. totalizer). ▪ Diagnostics Error detection and analysis of process and device errors and for device simulation and Heartbeat Technology.

8.3 Access to the operating menu via the operating tool

8.3.1 Connecting the operating tool

Via service interface (CDI)

Modbus RS485

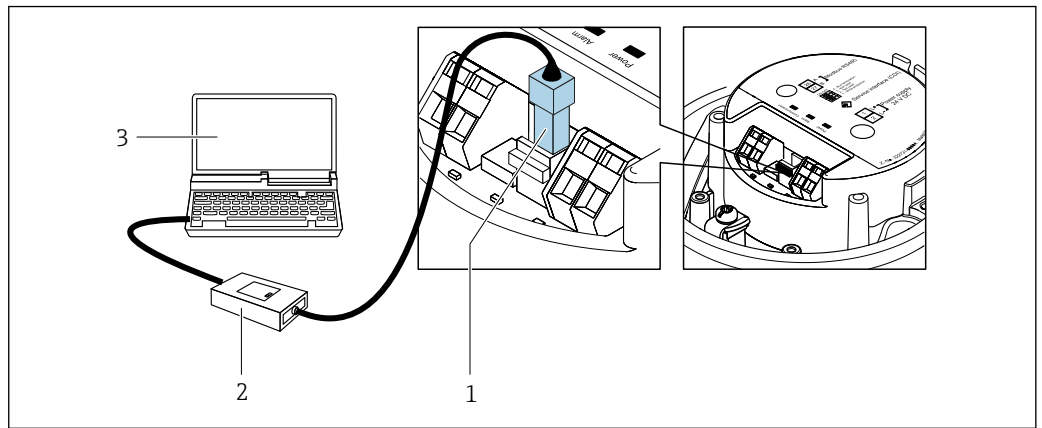

A0030216

- 1 Service interface (CDI) of measuring device
- 2 Commubox FXA291
- 3 Computer with "FieldCare" operating tool with COM DTM "CDI Communication FXA291"

Via service interface (CDI)

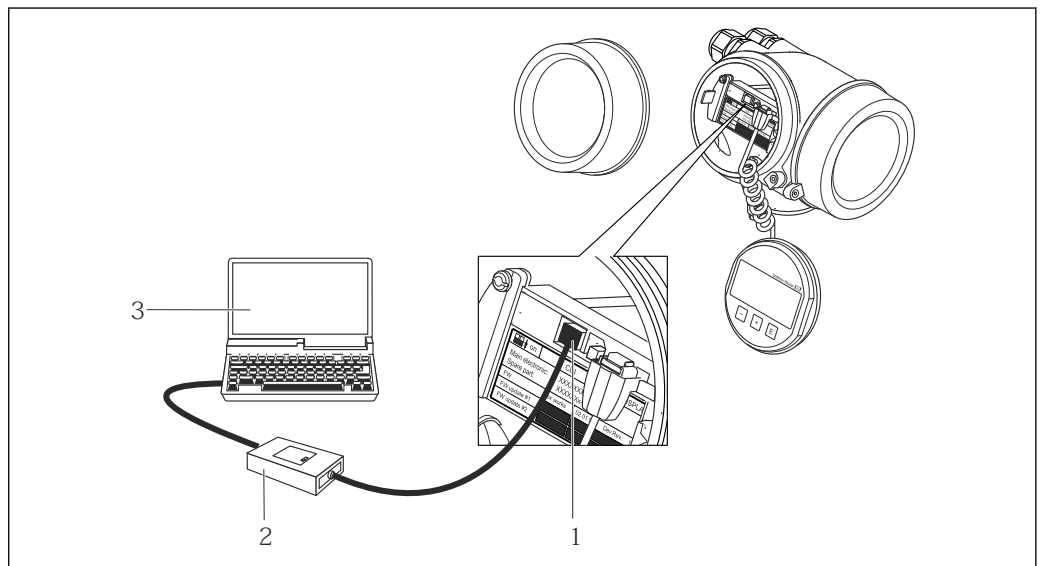

A0014019

- 1 Service interface (CDI = Endress+Hauser Common Data Interface) of the measuring device
- 2 Commubox FXA291
- 3 Computer with FieldCare operating tool with COM DTM CDI Communication FXA291

8.3.2 FieldCare

Function scope

FDT-based plant asset management tool from Endress+Hauser. It can configure all smart field devices in a system and helps you manage them. By using the status information, it is also a simple but effective way of checking their status and condition.

Access is via:

CDI service interface → 41

Typical functions:

- Configuring parameters of transmitters
- Loading and saving device data (upload/download)
- Documentation of the measuring point
- Visualization of the measured value memory (line recorder) and event logbook



For additional information about FieldCare, see Operating Instructions BA00027S and BA00059S

Source for device description files

See information →  44

Establishing a connection

1. Start FieldCare and launch the project.
2. In the network: Add a device.
 - ↳ The **Add device** window opens.
3. Select the **CDI Communication FXA291** option from the list and press **OK** to confirm.
4. Right-click **CDI Communication FXA291** and select the **Add device** option in the context menu that opens.
5. Select the desired device from the list and press **OK** to confirm.
6. Establish the online connection to the device.



For additional information, see Operating Instructions BA00027S and BA00059S

User interface

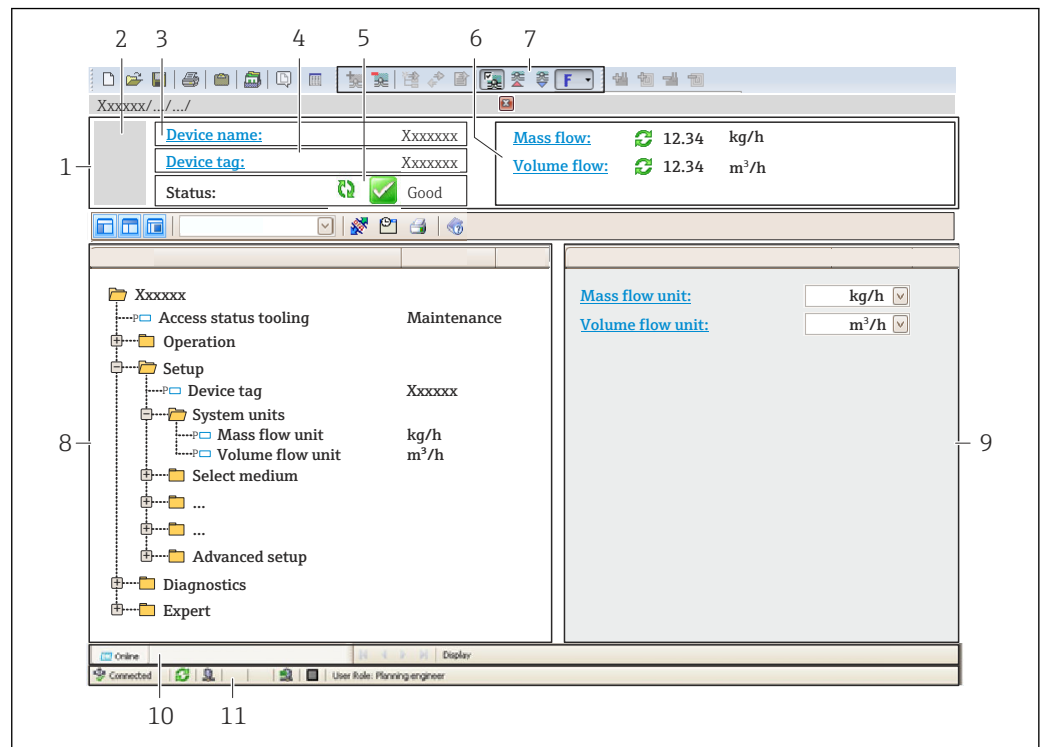

A0021051-EN

- 1 Header
- 2 Picture of device
- 3 Device name
- 4 Tag name
- 5 Status area with status signal → 65
- 6 Display area for current measured values
- 7 Edit toolbar with additional functions such as save/restore, event list and create documentation
- 8 Navigation area with operating menu structure
- 9 Working area
- 10 Range of action
- 11 Status area

8.3.3 DeviceCare

Function scope

Tool to connect and configure Endress+Hauser field devices.

The fastest way to configure Endress+Hauser field devices is with the dedicated "DeviceCare" tool. Together with the device type managers (DTMs) it presents a convenient, comprehensive solution.

 For details, see Innovation Brochure IN01047S

Source for device description files

See information →  44

9 System integration

9.1 Overview of device description files

9.1.1 Current version data for the device

Firmware version	01.01.zz	<ul style="list-style-type: none"> ▪ On the title page of the Operating instructions ▪ On the transmitter nameplate ▪ Firmware version Diagnostics → Device information → Firmware version
Release date of firmware version	06.2014	---

 For an overview of the different firmware versions for the device

9.1.2 Operating tools





The suitable device description file for the individual operating tools is listed in the table below, along with information on where the file can be acquired.

Operating tool via Service interface (CDI)	Sources for obtaining device descriptions
FieldCare	<ul style="list-style-type: none"> ▪ www.endress.com → Download Area ▪ CD-ROM (contact Endress+Hauser) ▪ DVD (contact Endress+Hauser)
DeviceCare	<ul style="list-style-type: none"> ▪ www.endress.com → Download Area ▪ CD-ROM (contact Endress+Hauser) ▪ DVD (contact Endress+Hauser)

9.2 Modbus RS485 information

9.2.1 Function codes

Function codes are used to define which read or write action is carried out via the Modbus protocol. The measuring device supports the following function codes:

Code	Name	Description	Application
03	Read holding register	<p>Master reads one or more Modbus registers from the device. A maximum of 125 consecutive registers can be read with 1 telegram: 1 register = 2 bytes</p> <p> The measuring device does not make a distinction between function codes 03 and 04; these codes therefore yield the same result.</p>	<p>Read device parameters with read and write access</p> <p>Example: Read volume flow</p>
04	Read input register	<p>Master reads one or more Modbus registers from the device. A maximum of 125 consecutive registers can be read with 1 telegram: 1 register = 2 bytes</p> <p> The measuring device does not make a distinction between function codes 03 and 04; these codes therefore yield the same result.</p>	<p>Read device parameters with read access</p> <p>Example: Read totalizer value</p>
06	Write single registers	<p>Master writes a new value to one Modbus register of the measuring device.</p> <p> Use function code 16 to write multiple registers with just 1 telegram.</p>	<p>Write only 1 device parameter</p> <p>Example: reset totalizer</p>
08	Diagnostics	<p>Master checks the communication connection to the measuring device. The following "Diagnostics codes" are supported:</p> <ul style="list-style-type: none"> ▪ Sub-function 00 = Return query data (loopback test) ▪ Sub-function 02 = Return diagnostics register 	
16	Write multiple registers	<p>Master writes a new value to multiple Modbus registers of the device. A maximum of 120 consecutive registers can be written with 1 telegram.</p> <p> If the required device parameters are not available as a group, yet must nevertheless be addressed with a single telegram, use Modbus data map →  46</p>	<p>Write multiple device parameters</p>
23	Read/Write multiple registers	<p>Master reads and writes a maximum of 118 Modbus registers of the measuring device simultaneously with 1 telegram. Write access is executed before read access.</p>	<p>Write and read multiple device parameters</p> <p>Example:</p> <ul style="list-style-type: none"> ▪ Read mass flow ▪ Reset totalizer

 Broadcast messages are only allowed with function codes 06, 16 and 23.

9.2.2 Register information

 For an overview of Modbus-specific information relating to the individual device parameters: Description of device parameters.

9.2.3 Response time

Response time of the measuring device to the request telegram of the Modbus master: typically 3 to 5 ms

9.2.4 Modbus data map

Function of the Modbus data map

The device offers a special memory area, the Modbus data map (for a maximum of 16 device parameters), to allow users to call up multiple device parameters via Modbus RS485 and not only individual device parameters or a group of consecutive device parameters.

Grouping of device parameters is flexible and the Modbus master can read or write to the entire data block simultaneously with a single request telegram.

Structure of the Modbus data map

The Modbus data map consists of two data sets:

- Scan list: Configuration area
 - The device parameters to be grouped are defined in a list in that their Modbus RS485 register addresses are entered in the list.
- Data area
 - The measuring device reads out the register addresses entered in the scan list cyclically and writes the associated device data (values) to the data area.



For an overview of device parameters with their individual Modbus register address, please refer to the additional document on Modbus RS485 register information

Scan list configuration

For configuration, the Modbus RS485 register addresses of the device parameters to be grouped must be entered in the scan list. Please note the following basic requirements of the scan list:

Max. entries	16 device parameters
Supported device parameters	Only parameters with the following characteristics are supported: <ul style="list-style-type: none"> ■ Access type: read or write access ■ Data type: float or integer

Configuring the scan list via FieldCare

Carried out using the operating menu of the measuring device:

Expert → Communication → Modbus data map → Scan list register 0 -15

Scan list	
No.	Configuration register
0	Scan list register 0
...	...
15	Scan list register 15

Configuring the scan list via Modbus RS485

Carried out using register addresses 5001 - 5016

Scan list			
No.	Modbus RS485 register	Data type	Configuration register
0	5001	Integer	Scan list register 0
...	...	Integer	...
15	5016	Integer	Scan list register 15

Reading out data via Modbus RS485

The Modbus master accesses the data area of the Modbus data map to read out the current values of the device parameters defined in the scan list.

Master access to data area	Via register addresses 5051-5081
-----------------------------------	----------------------------------



Data area			
Device parameter value	Modbus RS485 register	Data type*	Access**
Value of scan list register 0	5051	Integer/float	Read/write
Value of scan list register 1	5053	Integer/float	Read/write
Value of scan list register
Value of scan list register 15	5081	Integer/float	Read/write

* Data type depends on the device parameters entered in the scan list.
 ** Data access depends on the device parameters entered in the scan list. If the device parameter entered supports read and write access, the parameter can also be accessed via the data area.



10 Commissioning

10.1 Function check

Before commissioning the measuring device:

- ▶ Make sure that the post-installation and post-connection checks have been performed.
 - "Post-installation check" checklist →  27
 - "Post-connection check" checklist →  37

10.2 Connecting via FieldCare

- For FieldCare connection
- For connecting via FieldCare →  42
- For the FieldCare →  43 user interface

10.3 Setting the operating language

Factory setting: English or ordered local language

The operating language can be set in FieldCare or DeviceCare: Operation → Display language

10.4 Configuring the measuring device

The **Setup** menu with its submenus contains all the parameters needed for standard operation.

Navigation

"Setup" menu

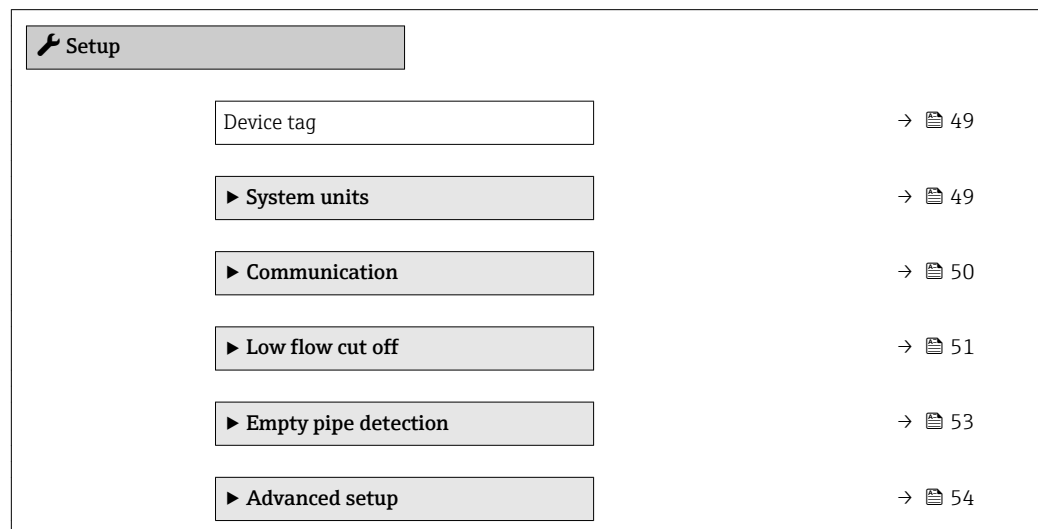

10.4.1 Defining the tag name

To enable fast identification of the measuring point within the system, you can enter a unique designation using the **Device tag** parameter and thus change the factory setting.

-  Enter the tag name in the "FieldCare" operating tool →  43

Navigation

"Setup" menu → Device tag

Parameter overview with brief description

Parameter	Description	User entry	Factory setting
Device tag	Enter the name for the measuring point.	Max. 32 characters such as letters, numbers or special characters (e.g. @, %, /).	Promag

10.4.2 Setting the system units









In the **System units** submenu the units of all the measured values can be set.

 Depending on the device version, not all submenus and parameters are available in every device. The selection can vary depending on the order code.

Navigation

"Setup" menu → Advanced setup → System units

▶ System units

- Volume flow unit →  49
- Volume unit →  49
- Conductivity unit →  50
- Temperature unit →  50
- Mass flow unit →  50
- Mass unit →  50
- Density unit →  50
- Corrected volume flow unit →  50
- Corrected volume unit →  50

Parameter overview with brief description

Parameter	Prerequisite	Description	Selection	Factory setting
Volume flow unit	–	Select volume flow unit. <i>Result</i> The selected unit applies for: <ul style="list-style-type: none"> ▪ Output ▪ Low flow cut off ▪ Simulation process variable 	Unit choose list	Country-specific: <ul style="list-style-type: none"> ▪ l/h ▪ gal/min (us)
Volume unit	–	Select volume unit.	Unit choose list	Country-specific: <ul style="list-style-type: none"> ▪ m³ ▪ gal (us)

Parameter	Prerequisite	Description	Selection	Factory setting
Conductivity unit	The On option is selected in the Conductivity measurement parameter parameter.	Select conductivity unit. <i>Effect</i> The selected unit applies for: Simulation process variable	Unit choose list	μS/cm
Temperature unit	–	Select temperature unit. <i>Result</i> The selected unit applies for: <ul style="list-style-type: none"> ▪ Temperature parameter ▪ Maximum value parameter ▪ Minimum value parameter ▪ External temperature parameter ▪ Maximum value parameter ▪ Minimum value parameter 	Unit choose list	Country-specific: <ul style="list-style-type: none"> ▪ °C ▪ °F
Mass flow unit	–	Select mass flow unit. <i>Result</i> The selected unit applies for: <ul style="list-style-type: none"> ▪ Output ▪ Low flow cut off ▪ Simulation process variable 	Unit choose list	Country-specific: <ul style="list-style-type: none"> ▪ kg/h ▪ lb/min
Mass unit	–	Select mass unit.	Unit choose list	Country-specific: <ul style="list-style-type: none"> ▪ kg ▪ lb
Density unit	–	Select density unit. <i>Result</i> The selected unit applies for: <ul style="list-style-type: none"> ▪ Output ▪ Simulation process variable 	Unit choose list	Country-specific: <ul style="list-style-type: none"> ▪ kg/l ▪ lb/ft³
Corrected volume flow unit	–	Select corrected volume flow unit. <i>Result</i> The selected unit applies for: Corrected volume flow parameter (→ ⓘ 60)	Unit choose list	Country-specific: <ul style="list-style-type: none"> ▪ NI/h ▪ Sft³/h
Corrected volume unit	–	Select corrected volume unit.	Unit choose list	Country-specific: <ul style="list-style-type: none"> ▪ Nm³ ▪ Sft³

10.4.3 Configuring the communication interface

The **Communication** submenu guides you systematically through all the parameters that have to be configured for selecting and setting the communication interface.

Navigation

"Setup" menu → Communication

▶ Communication

Bus address

→ ⓘ 51

Baudrate

→ ⓘ 51

Data transfer mode

→ ⓘ 51

Parity	→ 51
Byte order	→ 51
Failure mode	→ 51

Parameter overview with brief description

Parameter	Description	User entry / Selection	Factory setting
Bus address	Enter device address.	1 to 247	247
Baudrate	Define data transfer speed.	<ul style="list-style-type: none"> ■ 1200 BAUD ■ 2400 BAUD ■ 4800 BAUD ■ 9600 BAUD ■ 19200 BAUD ■ 38400 BAUD ■ 57600 BAUD ■ 115200 BAUD 	19200 BAUD
Data transfer mode	Select data transfer mode.	<ul style="list-style-type: none"> ■ ASCII ■ RTU 	RTU
Parity	Select parity bits.	Picklist ASCII option: <ul style="list-style-type: none"> ■ 0 = Even option ■ 1 = Odd option Picklist RTU option: <ul style="list-style-type: none"> ■ 0 = Even option ■ 1 = Odd option ■ 2 = None / 1 stop bit option ■ 3 = None / 2 stop bits option 	Even
Byte order	Select byte transmission sequence.	<ul style="list-style-type: none"> ■ 0-1-2-3 ■ 3-2-1-0 ■ 1-0-3-2 ■ 2-3-0-1 	1-0-3-2
Assign diagnostic behavior	Select diagnostic behavior for MODBUS communication.	<ul style="list-style-type: none"> ■ Off ■ Alarm or warning ■ Warning ■ Alarm 	Alarm
Failure mode	Select measured value output behavior when a diagnostic message occurs via Modbus communication. NaN ¹⁾	<ul style="list-style-type: none"> ■ NaN value ■ Last valid value 	NaN value

1) Not a Number

10.4.4 Configuring the low flow cut off

The **Low flow cut off** submenu contains the parameters that must be set in order to configure the low flow cut off.

Navigation

"Setup" menu → Low flow cut off

▶ Low flow cut off	
Assign process variable	→ 52

On value low flow cutoff	→ 52
Off value low flow cutoff	→ 52
Pressure shock suppression	→ 52

Parameter overview with brief description

Parameter	Prerequisite	Description	Selection / User entry	Factory setting
Assign process variable	–	Select process variable for low flow cut off.	<ul style="list-style-type: none"> ■ Off ■ Volume flow ■ Mass flow ■ Corrected volume flow 	Volume flow
On value low flow cutoff	One of the following options is selected in the Assign process variable parameter (→ 52): <ul style="list-style-type: none"> ■ Volume flow ■ Mass flow ■ Corrected volume flow 	Enter on value for low flow cut off.	Signed floating-point number	Depends on country and nominal diameter
Off value low flow cutoff	One of the following options is selected in the Assign process variable parameter (→ 52): <ul style="list-style-type: none"> ■ Volume flow ■ Mass flow ■ Corrected volume flow 	Enter off value for low flow cut off.	0 to 100.0 %	50 %
Pressure shock suppression	One of the following options is selected in the Assign process variable parameter (→ 52): <ul style="list-style-type: none"> ■ Volume flow ■ Mass flow ■ Corrected volume flow 	Enter time frame for signal suppression (= active pressure shock suppression).	0 to 100 s	0 s

10.4.5 Configuring empty pipe detection

The **Empty pipe detection** submenu contains parameters that must be configured for the configuration of empty pipe detection.

Navigation

"Setup" menu → Empty pipe detection

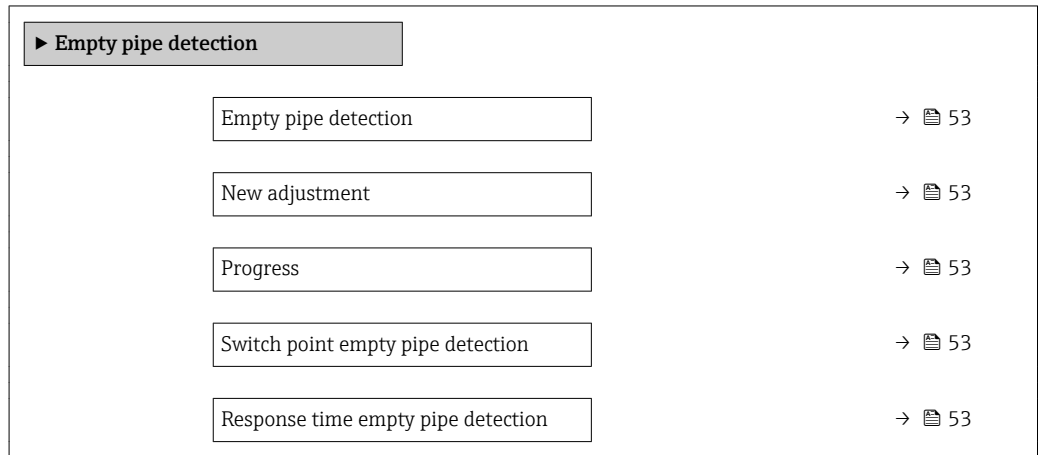

Parameter overview with brief description

Parameter	Prerequisite	Description	Selection / User interface / User entry	Factory setting
Empty pipe detection	–	Switch empty pipe detection on and off.	<ul style="list-style-type: none"> ■ Off ■ On 	Off
New adjustment	The On option is selected in the Empty pipe detection parameter.	Select type of adjustment.	<ul style="list-style-type: none"> ■ Cancel ■ Empty pipe adjust ■ Full pipe adjust 	Cancel
Progress	The On option is selected in the Empty pipe detection parameter.	Shows the progress.	<ul style="list-style-type: none"> ■ Ok ■ Busy ■ Not ok 	–
Switch point empty pipe detection	The On option is selected in the Empty pipe detection parameter.	Enter hysteresis in %, below this value the measuring tube will detected as empty.	0 to 100 %	10 %
Response time empty pipe detection	In the Empty pipe detection parameter (→ 53), the On option is selected.	Enter the time before diagnostic message S862 'Pipe empty' is displayed for empty pipe detection.	0 to 100 s	1 s

10.5 Advanced settings

The **Advanced setup** submenu together with its submenus contains parameters for specific settings.

Navigation

"Setup" menu → Advanced setup

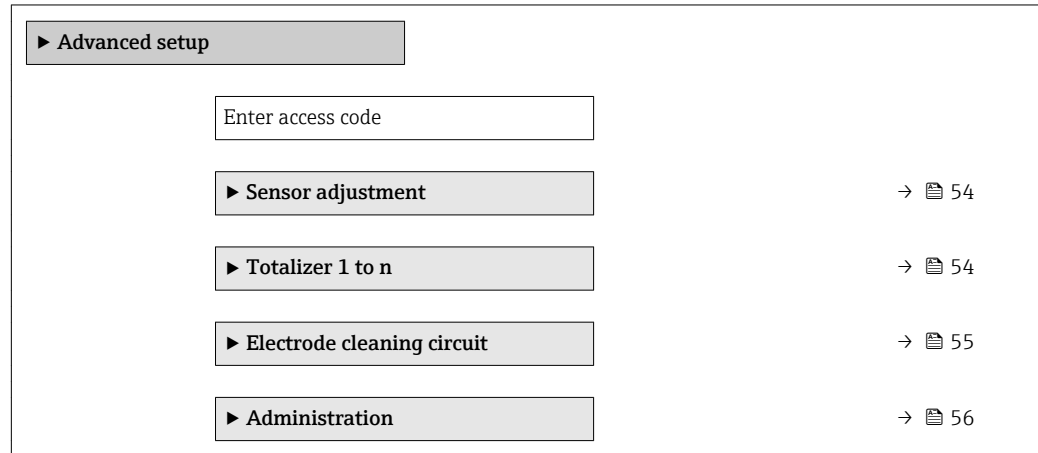

10.5.1 Carrying out a sensor adjustment

The **Sensor adjustment** submenu contains parameters that pertain to the functionality of the sensor.

Navigation

"Setup" menu → Advanced setup → Sensor adjustment

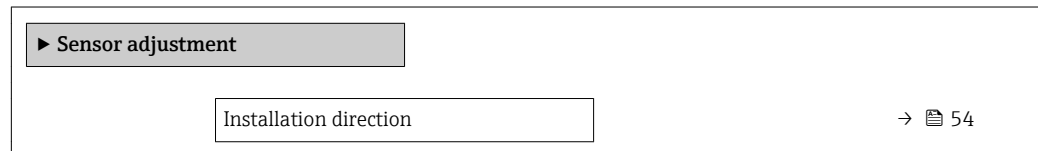

Parameter overview with brief description

Parameter	Description	Selection	Factory setting
Installation direction	Set sign of flow direction to match the direction of the arrow on the sensor.	<ul style="list-style-type: none"> ▪ Flow in arrow direction ▪ Flow against arrow direction 	Flow in arrow direction

10.5.2 Configuring the totalizer

In the **"Totalizer 1 to n"** submenu the individual totalizer can be configured.

Navigation

"Setup" menu → Advanced setup → Totalizer 1 to n

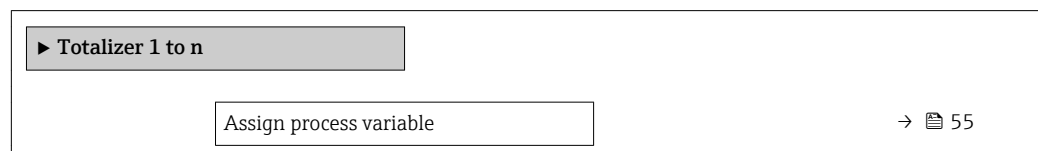

Unit totalizer	→ ⓘ 55
Totalizer operation mode	→ ⓘ 55
Failure mode	→ ⓘ 55

Parameter overview with brief description

Parameter	Prerequisite	Description	Selection	Factory setting
Assign process variable	–	Select process variable for totalizer.	<ul style="list-style-type: none"> ▪ Off ▪ Volume flow ▪ Mass flow ▪ Corrected volume flow 	Mass flow
Unit totalizer	One of the following options is selected in the Assign process variable parameter (→ ⓘ 55) of the Totalizer 1 to n submenu: <ul style="list-style-type: none"> ▪ Volume flow ▪ Mass flow ▪ Corrected volume flow 	Select process variable totalizer unit.	Unit choose list	Country-specific: <ul style="list-style-type: none"> ▪ l ▪ gal (us)
Totalizer operation mode	One of the following options is selected in the Assign process variable parameter (→ ⓘ 55) of the Totalizer 1 to n submenu: <ul style="list-style-type: none"> ▪ Volume flow ▪ Mass flow ▪ Corrected volume flow 	Select totalizer calculation mode.	<ul style="list-style-type: none"> ▪ Net flow total ▪ Forward flow total ▪ Reverse flow total 	Net flow total
Failure mode	One of the following options is selected in the Assign process variable parameter (→ ⓘ 55) of the Totalizer 1 to n submenu: <ul style="list-style-type: none"> ▪ Volume flow ▪ Mass flow ▪ Corrected volume flow 	Define totalizer behavior in alarm condition.	<ul style="list-style-type: none"> ▪ Stop ▪ Actual value ▪ Last valid value 	Stop

10.5.3 Performing electrode cleaning

The **Electrode cleaning circuit** submenu contains parameters that must be configured for the configuration of electrode cleaning.

 The submenu is only available if the device was ordered with electrode cleaning.

Navigation

"Setup" menu → Advanced setup → Electrode cleaning circuit

▶ Electrode cleaning circuit	
Electrode cleaning circuit	→ ⓘ 56
ECC duration	→ ⓘ 56

ECC recovery time	→ 56
ECC cleaning cycle	→ 56
ECC Polarity	→ 56

Parameter overview with brief description

Parameter	Prerequisite	Description	Selection / User entry / User interface	Factory setting
Electrode cleaning circuit	For the following order code: "Application package", option EC "ECC electrode cleaning"	Enable the cyclic electrode cleaning circuit.	<ul style="list-style-type: none"> ▪ Off ▪ On 	Off
ECC duration	For the following order code: "Application package", option EC "ECC electrode cleaning"	Enter the duration of electrode cleaning in seconds.	0.01 to 30 s	2 s
ECC recovery time	For the following order code: "Application package", option EC "ECC electrode cleaning"	Define recovery time after electrode cleaning. During this time the current output values will be held at last valid value.	1 to 600 s	60 s
ECC cleaning cycle	For the following order code: "Application package", option EC "ECC electrode cleaning"	Enter the pause duration between electrode cleaning cycles.	0.5 to 168 h	0.5 h
ECC Polarity	For the following order code: "Application package", option EC "ECC electrode cleaning"	Select the polarity of the electrode cleaning circuit.	<ul style="list-style-type: none"> ▪ Positive ▪ Negative 	Depends on the electrode material: <ul style="list-style-type: none"> ▪ Platinum: Negative option ▪ Tantalum, Alloy C22, stainless steel: Positive option

10.5.4 Using parameters for device administration

The **Administration** submenu systematically guides the user through all the parameters that can be used for device administration purposes.

Navigation

"Setup" menu → Advanced setup → Administration

<p>▶ Administration</p>	<p>Device reset</p>	→ 56
-------------------------	---------------------	------

Parameter overview with brief description

Parameter	Description	Selection	Factory setting
Device reset	Reset the device configuration - either entirely or in part - to a defined state.	<ul style="list-style-type: none"> ▪ Cancel ▪ To delivery settings ▪ Restart device 	Cancel

10.6 Simulation

The **Simulation** submenu enables you to simulate, without a real flow situation, various process variables in the process and the device alarm mode and to verify downstream signal chains (switching valves or closed-control loops).

Navigation

"Diagnostics" menu → Simulation

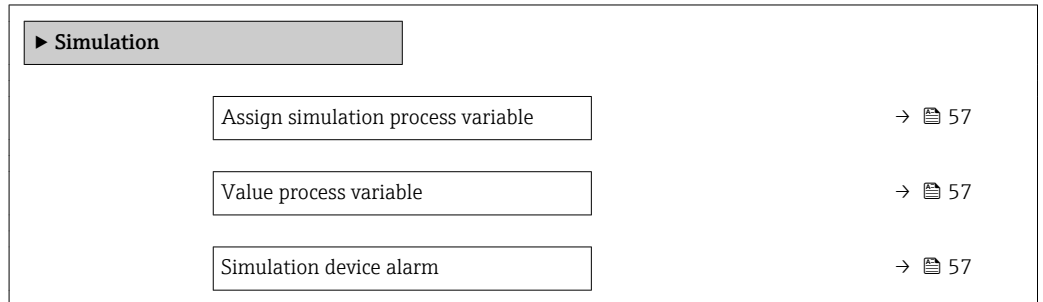

Parameter overview with brief description

Parameter	Prerequisite	Description	Selection / User entry	Factory setting
Assign simulation process variable	–	Select a process variable for the simulation process that is activated.	<ul style="list-style-type: none"> ▪ Off ▪ Volume flow ▪ Mass flow ▪ Corrected volume flow ▪ Conductivity * 	Off
Value process variable	One of the following options is selected in the Assign simulation process variable parameter (→ 57): <ul style="list-style-type: none"> ▪ Volume flow ▪ Mass flow ▪ Corrected volume flow ▪ Conductivity * ▪ Corrected conductivity * ▪ Temperature * 	Enter the simulation value for the selected process variable.	Depends on the process variable selected	0
Simulation device alarm	–	Switch the device alarm on and off.	<ul style="list-style-type: none"> ▪ Off ▪ On 	Off

* Visibility depends on order options or device settings

10.7 Protecting settings from unauthorized access

The following options exist for protecting the configuration of the measuring device from unintentional modification after commissioning:

Write protection via write protection switch → 57

10.7.1 Write protection via write protection switch

The write protection switch makes it possible to block write access to the entire operating menu with the exception of the following parameters:

- External pressure
- External temperature
- Reference density
- All parameters for configuring the totalizer

The parameter values are now read only and cannot be edited any more:

- Via service interface (CDI)
- Via Modbus RS485

1. Depending on the housing version, loosen the securing clamp or fixing screw of the housing cover.
2. Depending on the housing version, unscrew or open the housing cover.
- 3.

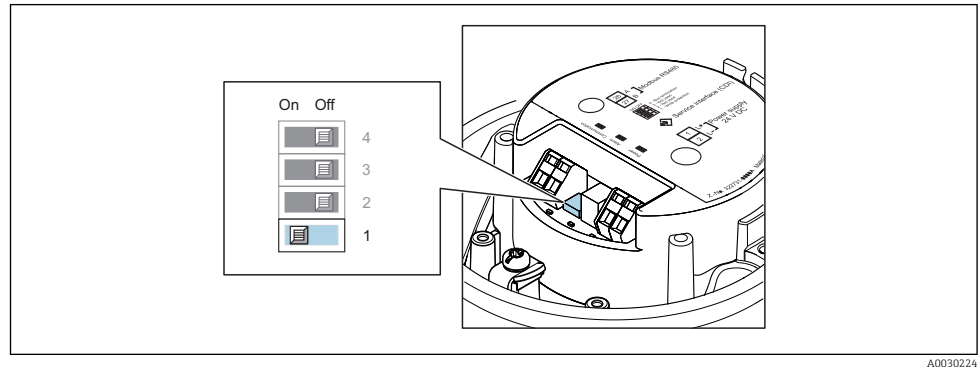

Setting the write protection switch on the main electronics module to the **On** position enables hardware write protection. Setting the write protection switch on the main electronics module to the **Off** position (factory setting) disables hardware write protection.

- ↳ If hardware write protection is enabled: the **Locking status** parameter displays the **Hardware locked** option ; if disabled, the **Locking status** parameter does not display any option .

4. Reverse the removal procedure to reassemble the transmitter.

11 Operation

11.1 Reading the device locking status

Device active write protection: **Locking status** parameter

Navigation

"Operation" menu → Locking status

Function scope of "Locking status" parameter

Options	Description
Hardware locked	The locking switch (DIP switch) for locking the hardware is activated on the main electronic module. This prevents write access to the parameters .
Temporarily locked	Write access to the parameters is temporarily locked on account of internal processes running in the device (e.g. data upload/download, reset etc.). Once the internal processing has been completed, the parameters can be changed once again.

11.2 Reading measured values

With the **Measured values** submenu, it is possible to read all the measured values.

Navigation

"Diagnostics" menu → Measured values

▶ Measured values

▶ Process variables → 📄 59

▶ Totalizer → 📄 60

▶ Input values

▶ Output values

11.2.1 "Process variables" submenu

The **Process variables** submenu contains all the parameters needed to display the current measured values for each process variable.

Navigation

"Diagnostics" menu → Measured values → Process variables

▶ Process variables

Volume flow → 📄 60

Mass flow → 📄 60

Conductivity	→ 60
Corrected volume flow	→ 60
Temperature	→ 60
Corrected conductivity	→ 60

Parameter overview with brief description

Parameter	Prerequisite	Description	User interface
Volume flow	-	Displays the volume flow currently measured. <i>Dependency</i> The unit is taken from the Volume flow unit parameter (→ 49).	Signed floating-point number
Mass flow	-	Displays the mass flow currently calculated. <i>Dependency</i> The unit is taken from the Mass flow unit parameter (→ 50).	Signed floating-point number
Corrected volume flow	-	Displays the corrected volume flow currently calculated. <i>Dependency</i> The unit is taken from the Corrected volume flow unit parameter (→ 50).	Signed floating-point number
Conductivity	The On option is selected in the Conductivity measurement parameter.	Displays the conductivity currently measured. <i>Dependency</i> The unit is taken from the Conductivity unit parameter (→ 50).	Signed floating-point number
Corrected conductivity	One of the following conditions is met: <ul style="list-style-type: none"> ■ Order code for "Sensor option", option CI "Medium temperature sensor" or ■ The temperature is read into the flowmeter from an external device. 	Displays the conductivity currently corrected. <i>Dependency</i> The unit is taken from the Conductivity unit parameter (→ 50).	Positive floating-point number
Temperature	For the following order code: "Sensor option", option CI "Medium temperature sensor"	Displays the temperature currently calculated. <i>Dependency</i> The unit is taken from the Temperature unit parameter (→ 50).	Positive floating-point number

11.2.2 "Totalizer" submenu

The **Totalizer** submenu contains all the parameters needed to display the current measured values for every totalizer.

Navigation

"Diagnostics" menu → Measured values → Totalizer

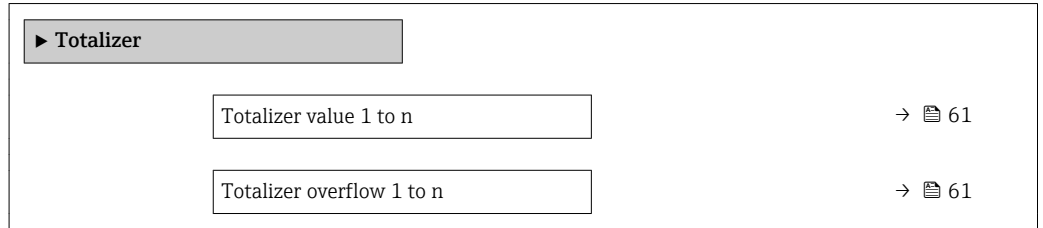

Parameter overview with brief description

Parameter	Prerequisite	Description	User interface
Totalizer value	One of the following options is selected in the Assign process variable parameter (→ 61 55) of the Totalizer 1 to n submenu: <ul style="list-style-type: none"> ▪ Volume flow ▪ Mass flow ▪ Corrected volume flow 	Displays the current totalizer counter value.	Signed floating-point number
Totalizer overflow	One of the following options is selected in the Assign process variable parameter (→ 61 55) of the Totalizer 1 to n submenu: <ul style="list-style-type: none"> ▪ Volume flow ▪ Mass flow ▪ Corrected volume flow 	Displays the current totalizer overflow.	Integer with sign

11.3 Adapting the measuring device to the process conditions

The following are available for this purpose:

- Basic settings using the **Setup** menu (→ 61 48)
- Advanced settings using the **Advanced setup** submenu (→ 61 54)

11.4 Performing a totalizer reset

The totalizers are reset in the **Operation** submenu:

- Control Totalizer
- Reset all totalizers

Navigation

"Operation" menu → Totalizer handling

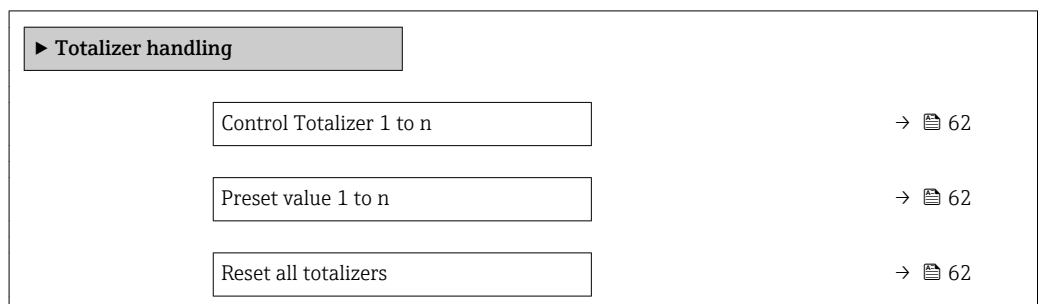

Parameter overview with brief description

Parameter	Prerequisite	Description	Selection / User entry	Factory setting
Control Totalizer	One of the following options is selected in the Assign process variable parameter (→ 55) of the Totalizer 1 to n submenu: <ul style="list-style-type: none"> ▪ Volume flow ▪ Mass flow ▪ Corrected volume flow 	Control totalizer value.	<ul style="list-style-type: none"> ▪ Totalize ▪ Reset + hold ▪ Preset + hold ▪ Reset + totalize ▪ Preset + totalize 	Totalize
Preset value	One of the following options is selected in the Assign process variable parameter (→ 55) of the Totalizer 1 to n submenu: <ul style="list-style-type: none"> ▪ Volume flow ▪ Mass flow ▪ Corrected volume flow 	Specify start value for totalizer. <i>Dependency</i>  The unit of the selected process variable is specified for the totalizer depending on the selection made in the Assign process variable parameter: <ul style="list-style-type: none"> ▪ Volume flow option: Volume flow unit parameter ▪ Mass flow option: Mass flow unit parameter ▪ Corrected volume flow option: Corrected volume unit parameter 	Signed floating-point number	0 kg
Reset all totalizers	–	Reset all totalizers to 0 and start.	<ul style="list-style-type: none"> ▪ Cancel ▪ Reset + totalize 	Cancel

11.4.1 Function scope of the "Control Totalizer" parameter

Options	Description
Totalize	The totalizer is started or continues running.
Reset + hold	The totaling process is stopped and the totalizer is reset to 0.
Preset + hold	The totaling process is stopped and the totalizer is set to its defined start value from the Preset value parameter.
Reset + totalize	The totalizer is reset to 0 and the totaling process is restarted.
Preset + totalize	The totalizer is set to the defined start value from the Preset value parameter and the totaling process is restarted.



11.4.2 Function scope of the "Reset all totalizers" parameter

Options	Description
Cancel	No action is executed and the user exits the parameter.
Reset + totalize	Resets all totalizers to 0 and restarts the totaling process. This deletes all the flow values previously totalized.





12 Diagnostics and troubleshooting

12.1 General troubleshooting

For output signals

Error	Possible causes	Solution
Green power LED on the main electronics module of the transmitter is dark	Supply voltage does not match the value indicated on the nameplate.	Apply the correct supply voltage .
Green power LED on the main electronics module of the transmitter is dark	Power supply cable connected incorrectly	Check the terminal assignment →  30.
Green power LED on Safety Barrier Promass 100 is dark	Supply voltage does not match the value indicated on the nameplate.	Apply the correct supply voltage .
Green power LED on Safety Barrier Promass 100 is dark	Power supply cable connected incorrectly	Check the terminal assignment →  30.
Device measures incorrectly.	Configuration error or device is operated outside the application.	1. Check and correct parameter configuration. 2. Observe limit values specified in the "Technical Data".

For access

Error	Possible causes	Solution
No write access to parameters	Hardware write protection enabled	Set the write protection switch on main electronics module to the OFF position →  57.
No connection via Modbus RS485	Modbus RS485 bus cable connected incorrectly	Check terminal assignment →  30.
No connection via Modbus RS485	Device plug connected incorrectly	Check the pin assignment of the connector →  31.
No connection via Modbus RS485	Modbus RS485 cable incorrectly terminated	Check terminating resistor .
No connection via Modbus RS485	Incorrect settings for the communication interface	Check the Modbus RS485 configuration →  50.
No connection via service interface	Incorrect configuration of USB interface on PC or driver not installed correctly.	Observe the documentation for the Commubox.  FXA291: Document "Technical Information" TI00405C
Not connecting to Web server	Incorrect IP address	Check the IP address: 192.168.1.212
Operation with FieldCare or DeviceCare via CDI-RJ45 service interface (port 8000)	Firewall of computer or network is preventing communication	Depending on the settings of the firewall used on the computer or in the network, the firewall must be adapted or disabled to allow FieldCare/DeviceCare access.
Flashing of firmware with FieldCare or DeviceCare via CDI-RJ45 service interface (via port 8000 or TFTP ports)	Firewall of computer or network is preventing communication	Depending on the settings of the firewall used on the computer or in the network, the firewall must be adapted or disabled to allow FieldCare/DeviceCare access.

12.2 Diagnostic information via light emitting diodes

12.2.1 Transmitter

Different LEDs in the transmitter provide information on the device status.

LED	Color	Meaning
Supply voltage	Off	Supply voltage is off or too low
	Green	Supply voltage is ok
Alarm	Off	Device status is ok
	Flashing red	A device error of diagnostic behavior "Warning" has occurred
	Red	<ul style="list-style-type: none"> ▪ A device error of diagnostic behavior "Alarm" has occurred ▪ Boot loader is active
Communication	Flashing white	Modbus RS485 communication is active

12.3 Diagnostic information in DeviceCare or FieldCare

12.3.1 Diagnostic options

Any faults detected by the measuring device are displayed on the home page of the operating tool once the connection has been established.

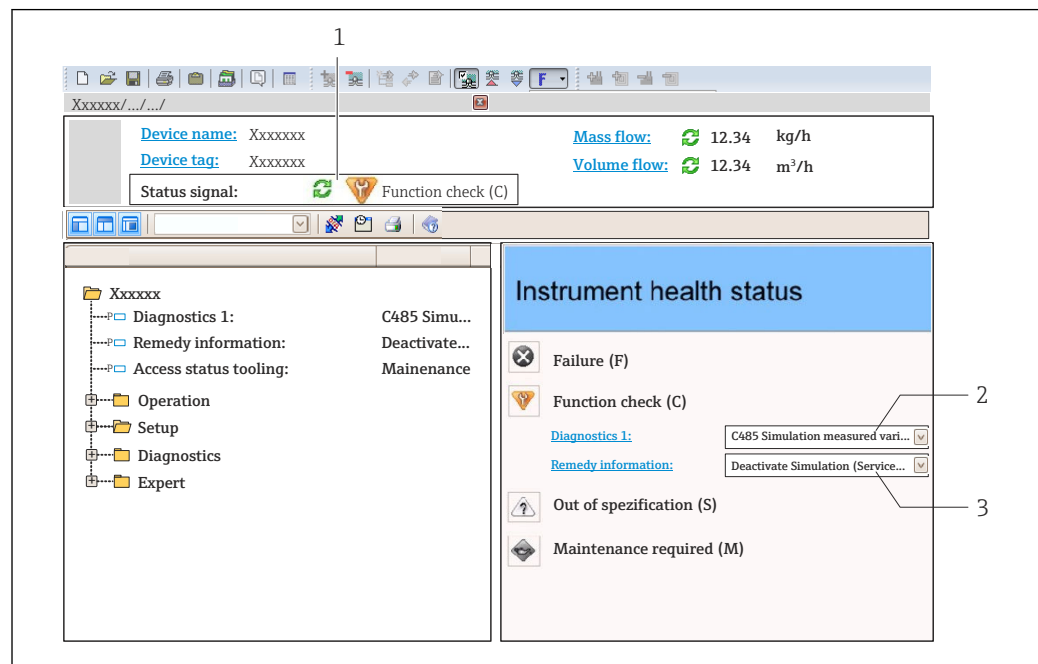

A0021799-EN





- 1 Status area with status signal
- 2 Diagnostic information → 65
- 3 Remedy information with Service ID

i In addition, diagnostic events which have occurred can be shown in the **Diagnostics** menu:

- Via parameter
- Via submenu → 69

Status signals

The status signals provide information on the state and reliability of the device by categorizing the cause of the diagnostic information (diagnostic event).

Symbol	Meaning
	Failure A device error has occurred. The measured value is no longer valid.
	Function check The device is in service mode (e.g. during a simulation).
	Out of specification The device is operated: Outside its technical specification limits (e.g. outside the process temperature range)
	Maintenance required Maintenance is required. The measured value is still valid.

 The status signals are categorized in accordance with VDI/VDE 2650 and NAMUR Recommendation NE 107.

Diagnostic information

The fault can be identified using the diagnostic information. The short text helps you by providing information about the fault.

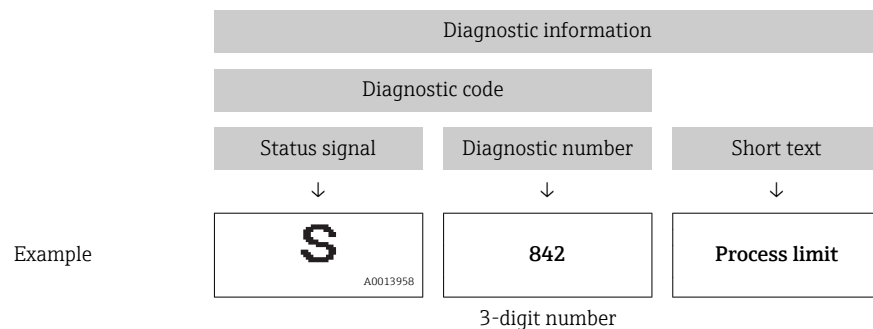

12.3.2 Calling up remedy information

Remedy information is provided for every diagnostic event to ensure that problems can be rectified quickly:

- On the home page
Remedy information is displayed in a separate field below the diagnostics information.
- In the **Diagnostics** menu
Remedy information can be called up in the working area of the user interface.

The user is in the **Diagnostics** menu.

1. Call up the desired parameter.
2. On the right in the working area, mouse over the parameter.
 - ↳ A tool tip with remedy information for the diagnostic event appears.

12.4 Diagnostic information via communication interface

12.4.1 Reading out diagnostic information

Diagnostic information can be read out via Modbus RS485 register addresses.

- Via register address **6821** (data type = string): diagnosis code, e.g. F270
- Via register address **6859** (data type = integer): diagnosis number, e.g. 270

 For an overview of diagnostic events with diagnosis number and diagnosis code →  66



12.4.2 Configuring error response mode

The error response mode for Modbus RS485 communication can be configured in the **Communication** submenu using 2 parameters.

Navigation path

Setup → Communication

Parameter overview with brief description

Parameters	Description	Selection	Factory setting
Failure mode	<p>Select measured value output behavior when a diagnostic message occurs via Modbus communication.</p> <p> This effect of this parameter depends on the option selected in the Assign diagnostic behavior parameter.</p>	<ul style="list-style-type: none"> ▪ NaN value ▪ Last valid value <p> NaN ≡ not a number</p>	NaN value

12.5 Adapting the diagnostic information

12.5.1 Adapting the diagnostic behavior

Each item of diagnostic information is assigned a specific diagnostic behavior at the factory. The user can change this assignment for specific diagnostic information in the **Diagnostic behavior** submenu.



Expert → System → Diagnostic handling → Diagnostic behavior

You can assign the following options to the diagnostic number as the diagnostic behavior:

Options	Description
Alarm	The device stops measurement. The measured value output via Modbus RS485 and the totalizers assume the defined alarm condition. A diagnostic message is generated.
Warning	The device continues to measure. The measured value output via Modbus RS485 and the totalizers are not affected. A diagnostic message is generated.
Logbook entry only	The device continues to measure. The diagnostic message is entered only in the Event logbook submenu.
Off	The diagnostic event is ignored, and no diagnostic message is generated or entered.

12.6 Overview of diagnostic information

 The amount of diagnostic information and the number of measured variables affected increase if the measuring device has one or more application packages.

 In the case of some items of diagnostic information, the diagnostic behavior can be changed. Change the diagnostic information →  66



Diagnostic number	Short text	Remedy instructions	Status signal [from the factory]	Diagnostic behavior [from the factory]
Diagnostic of sensor				
004	Sensor	1. Change sensor 2. Contact service	S	Alarm
022	Sensor temperature	1. Change main electronic module 2. Change sensor	F	Alarm
043	Sensor short circuit	1. Check sensor and cable 2. Change sensor or cable	S	Warning
062	Sensor connection	1. Check sensor connections 2. Contact service	F	Alarm
082	Data storage	1. Check module connections 2. Contact service	F	Alarm
083	Memory content	1. Restart device 2. Contact service	F	Alarm
Diagnostic of electronic				
222	Electronic drift	Change main electronic module	F	Alarm
242	Software incompatible	1. Check software 2. Flash or change main electronics module	F	Alarm
270	Main electronic failure	Change main electronic module	F	Alarm
271	Main electronic failure	1. Restart device 2. Change main electronic module	F	Alarm
272	Main electronic failure	1. Restart device 2. Contact service	F	Alarm
273	Main electronic failure	Change electronic	F	Alarm
281	Electronic initialization	Firmware update active, please wait!	F	Alarm
302	Device verification active	Device verification active, please wait.	C	Warning ¹⁾
311	Electronic failure	1. Reset device 2. Contact service	F	Alarm
322	Electronic drift	1. Perform verification manually 2. Change electronic	S	Warning
Diagnostic of configuration				
410	Data transfer	1. Check connection 2. Retry data transfer	F	Alarm
411	Up-/download active	Up-/download active, please wait	C	Warning
438	Dataset	1. Check data set file 2. Check device configuration 3. Up- and download new configuration	M	Warning
453	Flow override	Deactivate flow override	C	Warning
484	Simulation failure mode	Deactivate simulation	C	Alarm
485	Simulation measured variable	Deactivate simulation	C	Warning
500	Electrode 1 potential exceeded	1. Check process cond. 2. Increase system pressure	F	Alarm
500	Electrode difference voltage too high		F	Alarm



Diagnostic number	Short text	Remedy instructions	Status signal [from the factory]	Diagnostic behavior [from the factory]
530	Electrode cleaning is running	1. Check process cond. 2. Increase system pressure	C	Warning
531	Empty pipe detection	Execute EPD adjustment	S	Warning ¹⁾
Diagnostic of process				
832	Electronic temperature too high	Reduce ambient temperature	S	Warning ¹⁾
833	Electronic temperature too low	Increase ambient temperature	S	Warning ¹⁾
834	Process temperature too high	Reduce process temperature	S	Warning ¹⁾
835	Process temperature too low	Increase process temperature	S	Warning ¹⁾
862	Empty pipe	1. Check for gas in process 2. Adjust empty pipe detection	S	Warning ¹⁾
882	Input signal	1. Check input configuration 2. Check external device or process conditions	F	Alarm
937	EMC interference	Change main electronic module	S	Warning ¹⁾
938	EMC interference	1. Check ambient conditions regarding EMC influence 2. Change main electronic module	F	Alarm

1) Diagnostic behavior can be changed.

12.7 Pending diagnostic events





The **Diagnostics** menu allows the user to view the current diagnostic event and the previous diagnostic event separately.

-  To call up the measures to rectify a diagnostic event:
 - Via "FieldCare" operating tool →  65
 - Via "DeviceCare" operating tool →  65

-  Other pending diagnostic events can be displayed in the **Diagnostic list** submenu →  69

Navigation

"Diagnostics" menu

Diagnostics	
Actual diagnostics	→  69
Previous diagnostics	→  69
Operating time from restart	→  69
Operating time	→  69

Parameter overview with brief description

Parameter	Prerequisite	Description	User interface
Actual diagnostics	A diagnostic event has occurred.	Shows the current occurred diagnostic event along with its diagnostic information.  If two or more messages occur simultaneously, the message with the highest priority is shown on the display.	Symbol for diagnostic behavior, diagnostic code and short message.
Previous diagnostics	Two diagnostic events have already occurred.	Shows the diagnostic event that occurred prior to the current diagnostic event along with its diagnostic information.	Symbol for diagnostic behavior, diagnostic code and short message.
Operating time from restart	–	Shows the time the device has been in operation since the last device restart.	Days (d), hours (h), minutes (m) and seconds (s)
Operating time	–	Indicates how long the device has been in operation.	Days (d), hours (h), minutes (m) and seconds (s)

12.8 Diagnostic list



Up to 5 currently pending diagnostic events can be displayed in the **Diagnostic list** submenu along with the associated diagnostic information. If more than 5 diagnostic events are pending, the events with the highest priority are shown on the display.

Navigation path

Diagnostics → Diagnostic list



To call up the measures to rectify a diagnostic event:

- Via "FieldCare" operating tool →  65
- Via "DeviceCare" operating tool →  65

12.9 Event logbook

12.9.1 Reading the event logbook

A chronological overview of the event messages that have occurred is provided in the events list which contains a maximum of 20 message entries. This list can be displayed via FieldCare if necessary.



Navigation path

Edit tool bar: **F** → Additional functions → Events list



The edit tool bar can be accessed via the FieldCare user interface →  41



This event history includes entries for:

- Diagnostic events →  66
- Information events →  70

In addition to the operation time of its occurrence and possible troubleshooting measures, each event is also assigned a symbol that indicates whether the event has occurred or has ended:

- Diagnostic event
 - ☺: Occurrence of the event
 - ☹: End of the event
- Information event
 - ☺: Occurrence of the event

 To call up the measures to rectify a diagnostic event:

- Via "FieldCare" operating tool →  65
- Via "DeviceCare" operating tool →  65

 For filtering the displayed event messages →  70

12.9.2 Filtering the event logbook

Using the **Filter options** parameter you can define which category of event message is displayed in the **Events list** submenu.

Navigation path

Diagnostics → Event logbook → Filter options

Filter categories

- All
- Failure (F)
- Function check (C)
- Out of specification (S)
- Maintenance required (M)
- Information (I)

12.9.3 Overview of information events

Unlike a diagnostic event, an information event is displayed in the event logbook only and not in the diagnostic list.

Info number	Info name
I1000	----- (Device ok)
I1089	Power on
I1090	Configuration reset
I1091	Configuration changed
I1110	Write protection switch changed
I1151	History reset
I1351	Empty pipe detection adjustment failure
I1353	Empty pipe detection adjustment ok
I1444	Device verification passed
I1445	Device verification failed
I1457	Failed: Measured error verification
I1459	Failed: I/O module verification
I1461	Failed: Sensor verification
I1462	Failed: Sensor electronic module verific.

12.10 Resetting the measuring device

Using the **Device reset** parameter (→  56) it is possible to reset the entire device configuration or some of the configuration to a defined state.

12.10.1 Function scope of the "Device reset" parameter

Options	Description
Cancel	No action is executed and the user exits the parameter.
To fieldbus defaults	Every parameter is reset to fieldbus default values.
To delivery settings	Every parameter for which a customer-specific default setting was ordered is reset to this customer-specific value. All other parameters are reset to the factory setting.  This option is not visible if no customer-specific settings have been ordered.
Restart device	The restart resets every parameter whose data are in the volatile memory (RAM) to the factory setting (e.g. measured value data). The device configuration remains unchanged.









12.11 Device information

The **Device information** submenu contains all parameters that display different information for device identification.





Navigation

"Diagnostics" menu → Device information

▶ Device information



Device tag	→  72
Serial number	→  72
Firmware version	→  72
Device name	→  72
Order code	→  72
Extended order code 1	→  72
Extended order code 2	→  72
Extended order code 3	→  72
ENP version	→  72

Parameter overview with brief description

Parameter	Description	User interface	Factory setting
Device tag	Shows name of measuring point.	Max. 32 characters, such as letters, numbers or special characters (e.g. @, %, /).	Promag 100
Serial number	Shows the serial number of the measuring device.	A maximum of 11-digit character string comprising letters and numbers.	–
Firmware version	Shows the device firmware version installed.	Character string in the format xx.yy.zz	–
Device name	Shows the name of the transmitter.  The name can be found on the nameplate of the transmitter.	Max. 32 characters such as letters or numbers.	Promag 100
Order code	Shows the device order code.  The order code can be found on the nameplate of the sensor and transmitter in the "Order code" field.	Character string composed of letters, numbers and certain punctuation marks (e.g. /).	–
Extended order code 1	Shows the 1st part of the extended order code.  The extended order code can also be found on the nameplate of the sensor and transmitter in the "Ext. ord. cd." field.	Character string	–
Extended order code 2	Shows the 2nd part of the extended order code.  The extended order code can also be found on the nameplate of the sensor and transmitter in the "Ext. ord. cd." field.	Character string	–
Extended order code 3	Shows the 3rd part of the extended order code.  The extended order code can also be found on the nameplate of the sensor and transmitter in the "Ext. ord. cd." field.	Character string	–
ENP version	Shows the version of the electronic nameplate (ENP).	Character string	2.02.00

12.12 Firmware history

Release date	Firmware version	Order code for "Firmware version"	Firmware changes	Documentation type	Documentation
06.2012	01.00.00	–	Original firmware	–	–
06.2014	01.01.zz	Option 72	New unit "Beer Barrel (BBL)"	Operating Instructions	BA01306D/06/EN/01.14

-  It is possible to flash the firmware to the current version or the previous version using the service interface.
-  For the compatibility of the firmware version with the previous version, the installed device description files and operating tools, observe the information about the device in the "Manufacturer's information" document.
-  The manufacturer's information is available:
 - In the Download Area of the Endress+Hauser web site: www.endress.com → Downloads
 - Specify the following details:
 - Product root: e.g. 5H1B
The product root is the first part of the order code: see the nameplate on the device.
 - Text search: Manufacturer's information
 - Media type: Documentation – Technical Documentation

13 Maintenance

13.1 Maintenance tasks

No special maintenance work is required.

13.1.1 Exterior cleaning

When cleaning the exterior of measuring devices, always use cleaning agents that do not attack the surface of the housing or the seals.

13.1.2 Interior cleaning

No interior cleaning is planned for the device.

13.1.3 Replacing seals

The sensor's seals (particularly aseptic molded seals) must be replaced periodically.

The interval between changes depends on the frequency of the cleaning cycles, the cleaning temperature and the medium temperature.

Replacement seals (accessory part) →  94

13.2 Measuring and test equipment

Endress+Hauser offers a wide variety of measuring and test equipment, such as W@M or device tests.

 Your Endress+Hauser Sales Center can provide detailed information on the services.

List of some of the measuring and testing equipment: →  77

13.3 Endress+Hauser services

Endress+Hauser offers a wide variety of services for maintenance such as recalibration, maintenance service or device tests.

 Your Endress+Hauser Sales Center can provide detailed information on the services.

14 Repairs

14.1 General notes

14.1.1 Repair and conversion concept

The Endress+Hauser repair and conversion concept provides for the following:

- The measuring devices have a modular design.
- Spare parts are grouped into logical kits with the associated Installation Instructions.
- Repairs are carried out by Endress+Hauser Service or by appropriately trained customers.
- Certified devices can only be converted to other certified devices by Endress+Hauser Service or at the factory.

14.1.2 Notes for repair and conversion

For repair and modification of a measuring device, observe the following notes:

- ▶ Use only original Endress+Hauser spare parts.
- ▶ Carry out the repair according to the Installation Instructions.
- ▶ Observe the applicable standards, federal/national regulations, Ex documentation (XA) and certificates.
- ▶ Document every repair and each conversion and enter them into the *W@M* life cycle management database.

14.2 Spare parts

W@M Device Viewer (www.endress.com/deviceviewer):

All the spare parts for the measuring device, along with the order code, are listed here and can be ordered. If available, users can also download the associated Installation Instructions.



Measuring device serial number:

- Is located on the nameplate of the device.
- Can be read out via the **Serial number** parameter (→  72) in the **Device information** submenu.

14.3 Endress+Hauser services

Endress+Hauser offers a wide range of services.



Your Endress+Hauser Sales Center can provide detailed information on the services.

14.4 Return

The measuring device must be returned if it is need of repair or a factory calibration, or if the wrong measuring device has been delivered or ordered. Legal specifications require Endress+Hauser, as an ISO-certified company, to follow certain procedures when handling products that are in contact with the medium.

To ensure safe, swift and professional device returns, please refer to the procedure and conditions for returning devices provided on the Endress+Hauser website at

<http://www.endress.com/support/return-material>

14.5 Disposal

14.5.1 Removing the measuring device

1. Switch off the device.

⚠ WARNING

Danger to persons from process conditions.

- ▶ Beware of hazardous process conditions such as pressure in the measuring device, high temperatures or aggressive fluids.

2. Carry out the mounting and connection steps from the "Mounting the measuring device" and "Connecting the measuring device" sections in reverse order. Observe the safety instructions.

14.5.2 Disposing of the measuring device

⚠ WARNING

Danger to personnel and environment from fluids that are hazardous to health.

- ▶ Ensure that the measuring device and all cavities are free of fluid residues that are hazardous to health or the environment, e.g. substances that have permeated into crevices or diffused through plastic.

Observe the following notes during disposal:

- ▶ Observe valid federal/national regulations.
- ▶ Ensure proper separation and reuse of the device components.

15 Accessories

Various accessories, which can be ordered with the device or subsequently from Endress+Hauser, are available for the device. Detailed information on the order code in question is available from your local Endress+Hauser sales center or on the product page of the Endress+Hauser website: www.endress.com.

15.1 Device-specific accessories

15.1.1 For the transmitter

Accessories	Description
Ground cable	Set, consisting of two ground cables for potential equalization.

15.1.2 For the sensor



Accessories	Description
Ground disks	Are used to ground the medium in lined measuring tubes to ensure proper measurement.  For details, see Installation Instructions EA00070D

15.2 Communication-specific accessories

Accessories	Description
Commubox FXA291	Connects Endress+Hauser field devices with a CDI interface (= Endress+Hauser Common Data Interface) and the USB port of a computer or laptop.  For details, see the "Technical Information" document TI405C/07

15.3 Service-specific accessories

Accessories	Description
Applicator	Software for selecting and sizing Endress+Hauser measuring devices: <ul style="list-style-type: none"> ▪ Choice of measuring devices for industrial requirements ▪ Calculation of all the necessary data for identifying the optimum flowmeter: e.g. nominal diameter, pressure loss, flow velocity and accuracy. ▪ Graphic illustration of the calculation results ▪ Determination of the partial order code, administration, documentation and access to all project-related data and parameters over the entire life cycle of a project. Applicator is available: <ul style="list-style-type: none"> ▪ Via the Internet: https://wapps.endress.com/applicator ▪ As a downloadable DVD for local PC installation.

W@M	<p>W@M Life Cycle Management</p> <p>Improved productivity with information at your fingertips. Data relevant to a plant and its components is generated from the first stages of planning and during the asset's complete life cycle.</p> <p>W@M Life Cycle Management is an open and flexible information platform with online and on-site tools. Instant access for your staff to current, in-depth data shortens your plant's engineering time, speeds up procurement processes and increases plant uptime.</p> <p>Combined with the right services, W@M Life Cycle Management boosts productivity in every phase. For more information, visit www.endress.com/lifecyclemanagement</p>
FieldCare	<p>FDT-based plant asset management tool from Endress+Hauser.</p> <p>It can configure all smart field units in your system and helps you manage them. By using the status information, it is also a simple but effective way of checking their status and condition.</p> <p> For details, see Operating Instructions BA00027S and BA00059S</p>
DeviceCare	<p>Tool for connecting and configuring Endress+Hauser field devices.</p> <p> For details, see Innovation brochure IN01047S</p>
Commubox FXA291	<p>Connects Endress+Hauser field devices with a CDI interface (= Endress+Hauser Common Data Interface) and the USB port of a computer or laptop.</p> <p> For details, see "Technical Information" TI00405C</p>

15.4 System components

Accessories	Description
Memograph M graphic data manager	<p>The Memograph M graphic data manager provides information on all the relevant measured variables. Measured values are recorded correctly, limit values are monitored and measuring points analyzed. The data are stored in the 256 MB internal memory and also on a SD card or USB stick.</p> <p> For details, see "Technical Information" TI00133R and Operating Instructions BA00247R</p>

16 Technical data

16.1 Application

The measuring device is only suitable for flow measurement of liquids with a minimum conductivity of 5 $\mu\text{S}/\text{cm}$.

Depending on the version ordered, the measuring device can also measure potentially explosive, flammable, poisonous and oxidizing media.

To ensure that the device remains in proper operating condition for its service life, use the measuring device only for media against which the process-wetted materials are sufficiently resistant.

16.2 Function and system design

Measuring principle Electromagnetic flow measurement on the basis of *Faraday's law of magnetic induction*.

Measuring system The device consists of a transmitter and a sensor.
 The device is available as a compact version:
 The transmitter and sensor form a mechanical unit.
 For information on the structure of the device →  11

16.3 Input

Measured variable **Direct measured variables**

- Volume flow (proportional to induced voltage)
- Electrical conductivity

Calculated measured variables

- Mass flow
- Corrected volume flow

Measuring range Typically $v = 0.01$ to 10 m/s (0.03 to 33 ft/s) with the specified accuracy
 Electrical conductivity: ≥ 5 $\mu\text{S}/\text{cm}$ for liquids in general

Flow characteristic values in SI units

Nominal diameter		Recommended flow min./max. full scale value ($v \sim 0.3/10$ m/s) [dm ³ /min]	Factory settings Low flow cut off ($v \sim 0.04$ m/s) [dm ³ /min]
[mm]	[in]		
15	½	4 to 100	0.5
25	1	9 to 300	1
32	–	15 to 500	2
40	1 ½	25 to 700	3
50	2	35 to 1 100	5

Nominal diameter		Recommended flow min./max. full scale value (v ~ 0.3/10 m/s) [dm ³ /min]	Factory settings Low flow cut off (v ~ 0.04 m/s) [dm ³ /min]
[mm]	[in]		
65	–	60 to 2 000	8
80	3	90 to 3 000	12
100	4	145 to 4 700	20
125	–	220 to 7 500	30
150	6	20 to 600 m ³ /h	2.5 m ³ /h
200	8	35 to 1 100 m ³ /h	5 m ³ /h
250	10	55 to 1 700 m ³ /h	7.5 m ³ /h
300	12	80 to 2 400 m ³ /h	10 m ³ /h
350	14	110 to 3 300 m ³ /h	15 m ³ /h
400	16	140 to 4 200 m ³ /h	20 m ³ /h
450	18	180 to 5 400 m ³ /h	25 m ³ /h
500	20	220 to 6 600 m ³ /h	30 m ³ /h
600	24	310 to 9 600 m ³ /h	40 m ³ /h

Flow characteristic values in US units

Nominal diameter		Recommended flow min./max. full scale value (v ~ 0.3/10 m/s) [gal/min]	Factory settings Low flow cut off (v ~ 0.04 m/s) [gal/min]
[in]	[mm]		
½	15	1.0 to 27	0.15
1	25	2.5 to 80	0.25
1 ½	40	7 to 190	0.75
2	50	10 to 300	1.25
3	80	24 to 800	2.5
4	100	40 to 1 250	4
6	150	90 to 2 650	12
8	200	155 to 4 850	15
10	250	250 to 7 500	30
12	300	350 to 10 600	45
14	350	500 to 15 000	60
16	400	600 to 19 000	60
18	450	800 to 24 000	90
20	500	1 000 to 30 000	120
24	600	1 400 to 44 000	180

Recommended measuring range



"Flow limit" section →  87

Input signal

External measured values

To increase the accuracy of certain measured variables or to calculate the corrected volume flow, the automation system can continuously write different measured values to the measuring device:

- Operating pressure to increase accuracy (Endress+Hauser recommends the use of a pressure measuring device for absolute pressure, e.g. Cerabar M or Cerabar S)
- Medium temperature to increase accuracy (e.g. iTEMP)
- Reference density for calculating the corrected volume flow

 Various pressure transmitters and temperature measuring devices can be ordered from Endress+Hauser: see "Accessories" section →  78

It is recommended to read in external measured values to calculate the following measured variables:

Corrected volume flow

Digital communication

The measured values are written from the automation system to the measuring device via Modbus RS485.

16.4 Output

Output signal

Modbus RS485

Physical interface	In accordance with EIA/TIA-485-A standard
Terminating resistor	Integrated, can be activated via DIP switch on the transmitter electronics module

Signal on alarm

Depending on the interface, failure information is displayed as follows:

Current output 4 to 20 mA

4 to 20 mA

Failure mode	Choose from: <ul style="list-style-type: none"> ■ 4 to 20 mA in accordance with NAMUR recommendation NE 43 ■ 4 to 20 mA in accordance with US ■ Min. value: 3.59 mA ■ Max. value: 22.5 mA ■ Freely definable value between: 3.59 to 22.5 mA ■ Actual value ■ Last valid value
---------------------	--

Pulse/frequency/switch output

Pulse output	
Failure mode	Choose from: <ul style="list-style-type: none"> ■ Actual value ■ No pulses
Frequency output	
Failure mode	Choose from: <ul style="list-style-type: none"> ■ Actual value ■ 0 Hz ■ Defined value: 0 to 12 500 Hz

Switch output	
Failure mode	Choose from: <ul style="list-style-type: none"> ▪ Current status ▪ Open ▪ Closed

Modbus RS485

Failure mode	Choose from: <ul style="list-style-type: none"> ▪ NaN value instead of current value ▪ Last valid value
--------------	---

Interface/protocol

- Via digital communication:
Modbus RS485
- Via service interface
CDI-RJ45 service interface

Plain text display	With information on cause and remedial measures
--------------------	---

Light emitting diodes (LED)

Status information	Status indicated by various light emitting diodes The following information is displayed depending on the device version: <ul style="list-style-type: none"> ▪ Supply voltage active ▪ Data transmission active ▪ Device alarm/error has occurred  Diagnostic information via light emitting diodes
--------------------	--

Low flow cut off The switch points for low flow cut off are user-selectable.

Galvanic isolation The following connections are galvanically isolated from each other:

- Outputs
- Power supply

Protocol-specific data	Protocol	Modbus Applications Protocol Specification V1.1
	Device type	Slave
	Slave address range	1 to 247
	Broadcast address range	0
	Function codes	<ul style="list-style-type: none"> ▪ 03: Read holding register ▪ 04: Read input register ▪ 06: Write single registers ▪ 08: Diagnostics ▪ 16: Write multiple registers ▪ 23: Read/write multiple registers
	Broadcast messages	Supported by the following function codes: <ul style="list-style-type: none"> ▪ 06: Write single registers ▪ 16: Write multiple registers ▪ 23: Read/write multiple registers

Supported baud rate	<ul style="list-style-type: none"> ▪ 1 200 BAUD ▪ 2 400 BAUD ▪ 4 800 BAUD ▪ 9 600 BAUD ▪ 19 200 BAUD ▪ 38 400 BAUD ▪ 57 600 BAUD ▪ 115 200 BAUD
Data transfer mode	<ul style="list-style-type: none"> ▪ ASCII ▪ RTU
Data access	<p>Each device parameter can be accessed via Modbus RS485.</p> <p> For Modbus register information, see "Description of device parameters" documentation</p>

16.5 Power supply

Terminal assignment →  30

Pin assignment, device plug →  31

Supply voltage The power unit must be tested to ensure it meets safety requirements (e.g. PELV, SELV).

Transmitter
DC 20 to 30 V

Power consumption **Transmitter**

Order code for "Output"	Maximum Power consumption
Option M : Modbus RS485	3.5 W

Current consumption **Transmitter**

Order code for "Output"	Maximum Current consumption	Maximum switch-on current
Option M : Modbus RS485	90 mA	10 A (< 0.8 ms)

Power supply failure

- Totalizers stop at the last value measured.
- Depending on the device version, the configuration is retained in the device memory or in the plug-in memory (HistoROM DAT).
- Error messages (incl. total operated hours) are stored.

Electrical connection →  32

Potential equalization →  34

Terminals **Transmitter**
Spring terminals for wire cross-sections 0.5 to 2.5 mm² (20 to 14 AWG)

- Cable entries
- Cable gland: M20 × 1.5 with cable ϕ 6 to 12 mm (0.24 to 0.47 in)
 - Thread for cable entry:
 - M20
 - G 1/2"
 - NPT 1/2"

Cable specification →  29

16.6 Performance characteristics

- Reference operating conditions
- Error limits following DIN EN 29104, in future ISO 20456
 - Water, typically +15 to +45 °C (+59 to +113 °F); 0.5 to 7 bar (73 to 101 psi)
 - Data as indicated in the calibration protocol
 - Accuracy based on accredited calibration rigs according to ISO 17025

Maximum measured error **Error limits under reference operating conditions**

o.r. = of reading

Volume flow

- $\pm 0.5\%$ o.r. ± 1 mm/s (0.04 in/s)
- Optional: $\pm 0.2\%$ o.r. ± 2 mm/s (0.08 in/s)

 Fluctuations in the supply voltage do not have any effect within the specified range.

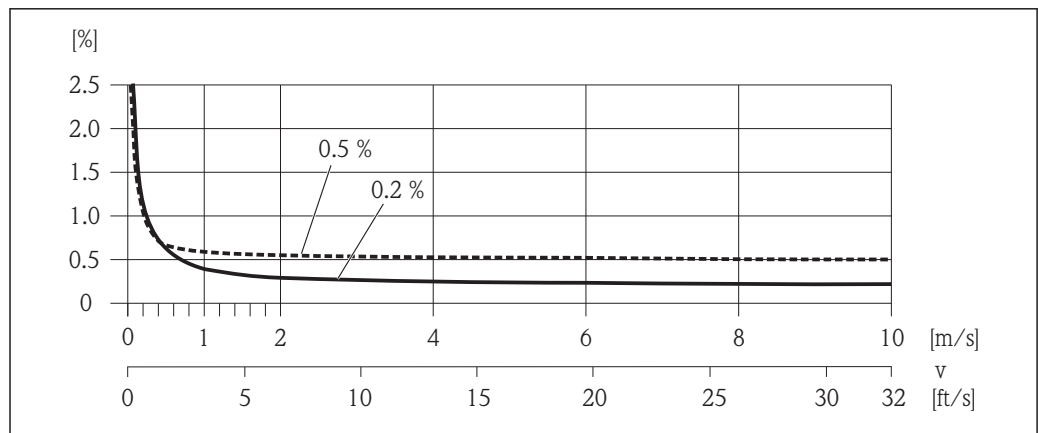

 16 Maximum measured error in % o.r.

Electrical conductivity

Max. measured error not specified.

Accuracy of outputs

 The output accuracy must be factored into the measured error if analog outputs are used, but can be ignored for fieldbus outputs (e.g. Modbus RS485, EtherNet/IP).

The outputs have the following base accuracy specifications.

Repeatability o.r. = of reading

Volume flow

Max. $\pm 0.1\%$ o.r. ± 0.5 mm/s (0.02 in/s)

Electrical conductivityMax. ± 5 % o.r.

 Temperature measurement response time $T_{90} < 15$ s

 Influence of ambient temperature **Current output**
o.r. = of reading

Temperature coefficient	Max. ± 0.005 % o.r./°C
--------------------------------	----------------------------

Pulse/frequency output

Temperature coefficient	No additional effect. Included in accuracy.
--------------------------------	---

16.7 Installation

"Mounting requirements"

16.8 Environment

 Ambient temperature range →  20
Temperature tables

 Observe the interdependencies between the permitted ambient and fluid temperatures when operating the device in hazardous areas.

 For detailed information on the temperature tables, see the separate document entitled "Safety Instructions" (XA) for the device.

 Storage temperature The storage temperature corresponds to the operating temperature range of the measuring transmitter and the appropriate measuring sensors. →  20

- Protect the measuring device against direct sunlight during storage in order to avoid unacceptably high surface temperatures.
- Select a storage location where moisture cannot collect in the measuring device as fungus or bacteria infestation can damage the liner.
- If protection caps or protective covers are mounted these should never be removed before installing the measuring device.

 Degree of protection **Transmitter and sensor**

- As standard: IP66/67, type 4X enclosure
- When housing is open: IP20, type 1 enclosure
- Display module: IP20, type 1 enclosure

Vibration resistance	<ul style="list-style-type: none"> ■ Vibration, sinusoidal according to IEC 60068-2-6 <ul style="list-style-type: none"> - 2 to 8.4 Hz, 3.5 mm peak - 8.4 to 2 000 Hz, 1 g peak ■ Vibration broad-band random, according to IEC 60068-2-64 <ul style="list-style-type: none"> - 10 to 200 Hz, 0.003 g²/Hz - 200 to 2 000 Hz, 0.001 g²/Hz - Total: 1.54 g rms
Shock resistance	Shock, half-sine according to IEC 60068-2-27 6 ms 30 g
Impact resistance	Rough handling shocks according to IEC 60068-2-31
Mechanical load	<ul style="list-style-type: none"> ■ Protect the transmitter housing against mechanical effects, such as shock or impact. ■ Never use the transmitter housing as a ladder or climbing aid.
Electromagnetic compatibility (EMC)	<ul style="list-style-type: none"> ■ As per IEC/EN 61326 and NAMUR Recommendation 21 (NE 21) ■ Complies with emission limits for industry as per EN 55011 (Class A) <p> Details are provided in the Declaration of Conformity.</p>

16.9 Process

Medium temperature range -10 to +110 °C (-4 to +230 °F)

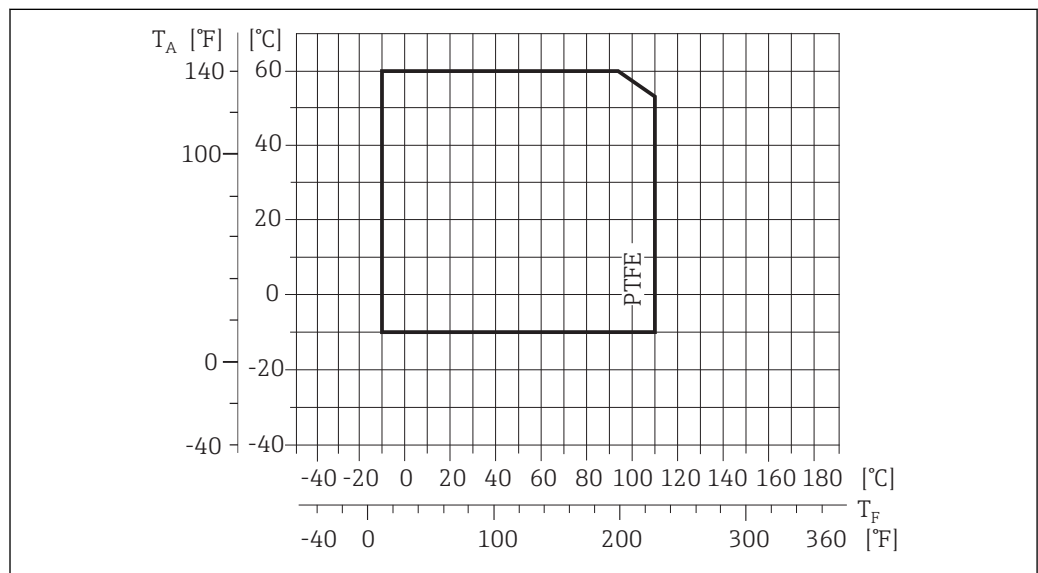

T_A Ambient temperature

T_F Medium temperature

Conductivity ≥ 5 μS/cm for liquids in general. Stronger filter damping is required for very low conductivity values.

Pressure-temperature ratings



An overview of the pressure-temperature ratings for the process connections is provided in the "Technical Information" document

Pressure tightness

"-" = no specifications possible

Liner: PTFE

Nominal diameter		Limit values for absolute pressure in [mbar] ([psi]) for fluid temperatures:			
[mm]	[in]	+25 °C (+77 °F)	+80 °C (+176 °F)	+100 °C (+212 °F)	+110 °C (+230 °F)
15	½	0 (0)	0 (0)	0 (0)	100 (1.45)
25	1	0 (0)	0 (0)	0 (0)	100 (1.45)
32	-	0 (0)	0 (0)	0 (0)	100 (1.45)
40	1 ½	0 (0)	0 (0)	0 (0)	100 (1.45)
50	2	0 (0)	0 (0)	0 (0)	100 (1.45)
65	-	0 (0)	-	40 (0.58)	130 (1.89)
80	3	0 (0)	-	40 (0.58)	130 (1.89)
100	4	0 (0)	-	135 (1.96)	170 (2.47)
125	-	135 (1.96)	-	240 (3.48)	385 (5.58)
150	6	135 (1.96)	-	240 (3.48)	385 (5.58)
200	8	200 (2.90)	-	290 (4.21)	410 (5.95)
250	10	330 (4.79)	-	400 (5.80)	530 (7.69)
300	12	400 (5.80)	-	500 (7.25)	630 (9.14)
350	14	470 (6.82)	-	600 (8.70)	730 (10.6)
400	16	540 (7.83)	-	670 (9.72)	800 (11.6)
450	18	No negative pressure permitted!			
500	20				
600	24				

Flow limit

The diameter of the pipe and the flow rate determine the nominal diameter of the sensor. The optimum velocity of flow is between 2 to 3 m/s (6.56 to 9.84 ft/s). Also match the velocity of flow (v) to the physical properties of the fluid:

- $v < 2$ m/s (6.56 ft/s): for abrasive fluids (e.g. potter's clay, lime milk, ore slurry)
- $v > 2$ m/s (6.56 ft/s): for fluids producing buildup (e.g. wastewater sludge)



A necessary increase in the flow velocity can be achieved by reducing the sensor nominal diameter.



For an overview of the full scale values for the measuring range, see the "Measuring range" section → 79

Pressure loss

- No pressure loss occurs if the sensor is installed in a pipe with the same nominal diameter.
- Pressure losses for configurations incorporating adapters according to DIN EN 545 → 21

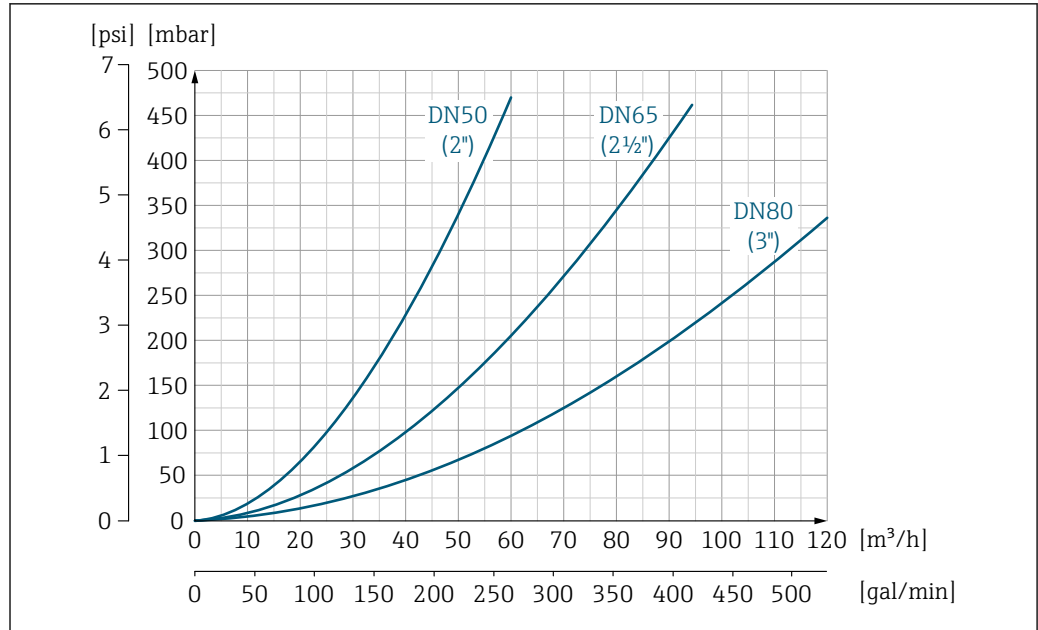

17 Pressure loss DN 50 to 80 (2 to 3") in the case of order code for "Design", option C "Insertion length short ISO/DVGW to DN300, without inlet/outlet runs, constricted meas.tube"

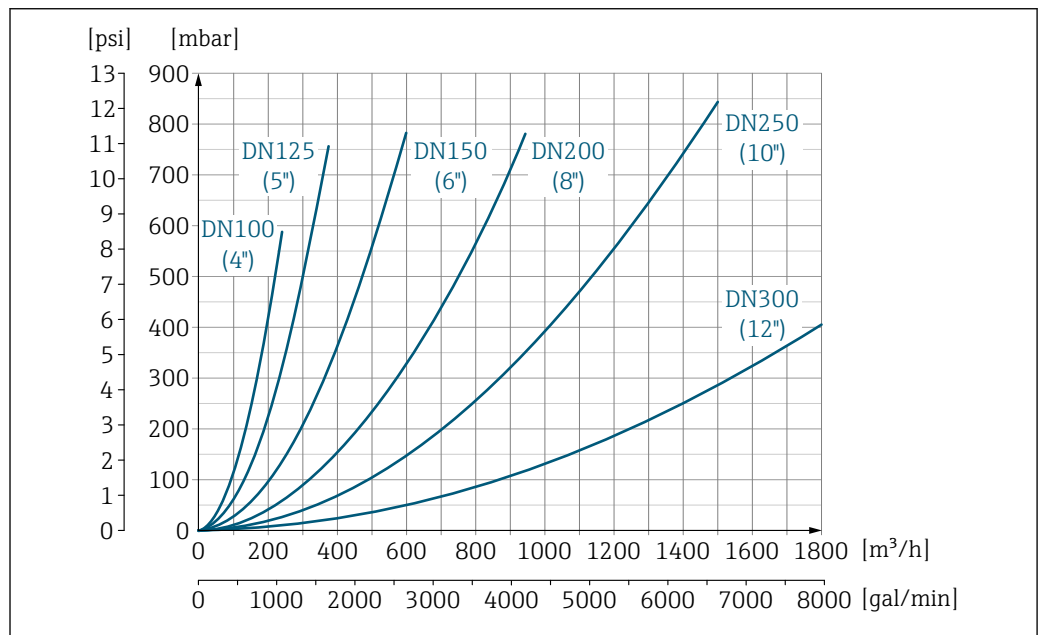

18 Pressure loss DN 100 to 300 (4 to 12") in the case of order code for "Design", option C "Insertion length short ISO/DVGW to DN300, without inlet/outlet runs, constricted meas.tube"

System pressure → 20

Vibrations → 21

16.10 Mechanical construction

Design, dimensions

For the dimensions and installation lengths of the device, see the "Technical Information" document, "Mechanical construction" section.

Weight

Compact version

- Including the transmitter (1.8 kg (4.0 lb))
- Weight specifications excluding packaging material

Weight in SI units

Nominal diameter		EN (DIN)				ASME	JIS
[mm]	[in]	PN 6 [kg]	PN 10 [kg]	PN 16 [kg]	PN 40 [kg]	Class 150 [kg]	10K [kg]
15	½	–	–	–	4.9	4.9	4.9
25	1	–	–	–	5.7	5.7	5.7
32	–	–	–	–	6.4	–	5.7
40	1 ½	–	–	–	7.8	7.8	6.7
50	2	–	–	–	9.0	9.0	7.7
65	–	–	–	10.4	–	–	9.5
80	3	–	–	12.4	–	12.4	10.9
100	4	–	–	14.4	–	14.4	13.1
125	–	–	–	19.9	–	–	19.4
150	6	–	–	23.9	–	23.9	22.9
200	8	–	43.4	44.4	–	43.4	40.3
250	10	–	63.4	68.4	–	73.4	67.8
300	12	–	68.4	79.4	–	108.4	70.7
350	14	75.8	86.8	102	–	135.8	79
400	16	87.8	102.8	123.8	–	166.8	100
450	18	101.7	116.7	147.6	–	190.9	128
500	20	113.2	130.8	188.3	–	226.8	142
600	24	153.8	179.4	298.3	–	327.1	188

Weight in US units

Nominal diameter		ASME
[mm]	[in]	Class 150 [lbs]
15	½	10.8
25	1	12.6
40	1 ½	17.2
50	2	19.9
80	3	27.3
100	4	31.8
150	6	52.7
200	8	95.7
250	10	161.9
300	12	239.0
350	14	299.4
400	16	367.8

Nominal diameter		ASME
[mm]	[in]	Class 150
		[lbs]
450	18	420.8
500	20	500.1
600	24	721.1

Measuring tube specification

Nominal diameter		Pressure rating			Process connection internal diameter	
[mm]	[in]	EN (DIN)	ASME	JIS	PTFE	
		[bar]	[psi]	[bar]	[mm]	[in]
15	½	PN 40	Class 150	20K	14	0.55
25	1	PN 40	Class 150	20K	26	1.02
32	-	PN 40	-	20K	34	1.34
40	1 ½	PN 40	Class 150	20K	40	1.57
50	2	PN 40	Class 150	10K	51	2.01
65	-	PN 16	-	10K	67	2.64
80	3	PN 16	Class 150	10K	79	3.11
100	4	PN 16	Class 150	10K	103	4.06
125	-	PN 16	-	10K	128	5.04
150	6	PN 16	Class 150	10K	155	6.10
200	8	PN 10/16	Class 150	10K	203	7.99
250	10	PN 10	-	10K	257	10.1
250	10	PN 16	Class 150	10K	255	10.0
300	12	PN 16	Class 150	10K	302	11.9
350	14	PN 6/10	-	10K	338	13.3
350	14	PN 16	Class 150	10K	334	13.1
400	16	PN 6/10	-	10K	388	15.3
400	16	PN 16	-	10K	386	15.2
400	16	-	Class 150	10K	384	15.1
450	18	PN 6/10	-	10K	440	17.3
450	18	PN 16	-	10K	438	17.2
450	18	-	Class 150	10K	434	17.1
500	20	PN 6/10	-	10K	491	19.3
500	20	PN 16	-	10K	487	19.2
500	20	-	Class 150	10K	485	19.1
600	24	PN 6	-	10K	592	23.3
600	24	PN 10	-	10K	590	23.2
600	24	PN 16	-	10K	588	23.2
600	24	-	Class 150	10K	582	22.9

Materials

Transmitter housing

Order code for "Housing", option **A** "Compact, aluminum coated":
Aluminum, AlSi10Mg, coated

Cable entries/cable glands

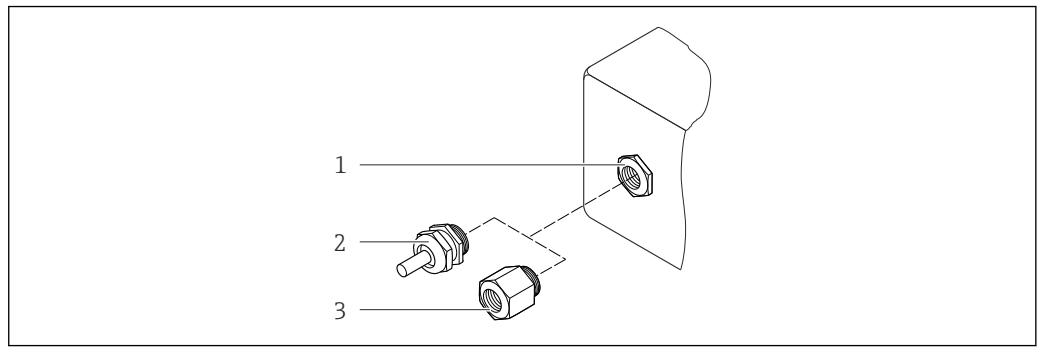

19 Possible cable entries/cable glands

- 1 Female thread M20 × 1.5
- 2 Cable gland M20 × 1.5
- 3 Adapter for cable entry with internal thread G ½" or NPT ½"

Order code for "Housing", option A "Compact, coated aluminum"

The various cable entries are suitable for hazardous and non-hazardous areas.

Cable entry/cable gland	Material
Cable gland M20 × 1.5	Nickel-plated brass
Adapter for cable entry with internal thread G ½"	
Adapter for cable entry with internal thread NPT ½"	

Device plug

Electrical connection	Material
Plug M12x1	<ul style="list-style-type: none"> ▪ Socket: Stainless steel, 1.4404 (316L) ▪ Contact housing: Polyamide ▪ Contacts: Gold-plated brass

Sensor housing

- DN 15 to 300 (½ to 12"): coated aluminum AlSi10Mg
- DN 350 to 600 (14 to 24"): carbon steel with protective varnish

Measuring tubes

Stainless steel, 1.4301/304/1.4306/304L; for flanges made of carbon with Al/Zn protective coating (DN 15 to 300 (½ to 12")) or protective varnish (DN 350 to 600 (14 to 24"))

Liner

PTFE

Process connections

EN 1092-1 (DIN 2501)
 Carbon steel, E250C ¹⁾/S235JRG2/P245GH
 ASME B16.5
 Carbon steel, A105

1) DN 15 to 300 (½ to 12") with Al/Zn-protective coating; DN 350 to 600 (14 to 24") with protective coating

JIS B2220
Carbon steel, A105/A350 LF2

Electrodes

Stainless steel, 1.4435 (F316L); Alloy C22, 2.4602 (UNS N06022); tantalum

Seals

As per DIN EN 1514-1, form IBC

Accessories

Ground disks

Stainless steel, 1.4435 (F316L); Alloy C22, 2.4602 (UNS N06022); tantalum; titanium

Fitted electrodes Measuring electrodes, reference electrodes and electrodes for empty pipe detection:
Standard: stainless steel, 1.4435 (F316L); Alloy C22, 2.4602 (UNS N06022); tantalum

Process connections

- EN 1092-1 (DIN 2501): DN ≤ 300 (12") Form A, DN ≥ 350 (14") Form B; dimensions DN 65 PN 16 and only as per EN 1092-1
- ASME B16.5
- JIS B2220
- AS 2129 Table E
- AS 4087 PN 16



Surface roughness Stainless steel electrodes, 1.4435 (F316L); Alloy C22, 2.4602 (UNS N06022); tantalum:
≤ 0.3 to 0.5 µm (11.8 to 19.7 µin)
(All data relate to parts in contact with fluid)

16.11 Operability

Service interface **Via service interface (CDI)**

Modbus RS485

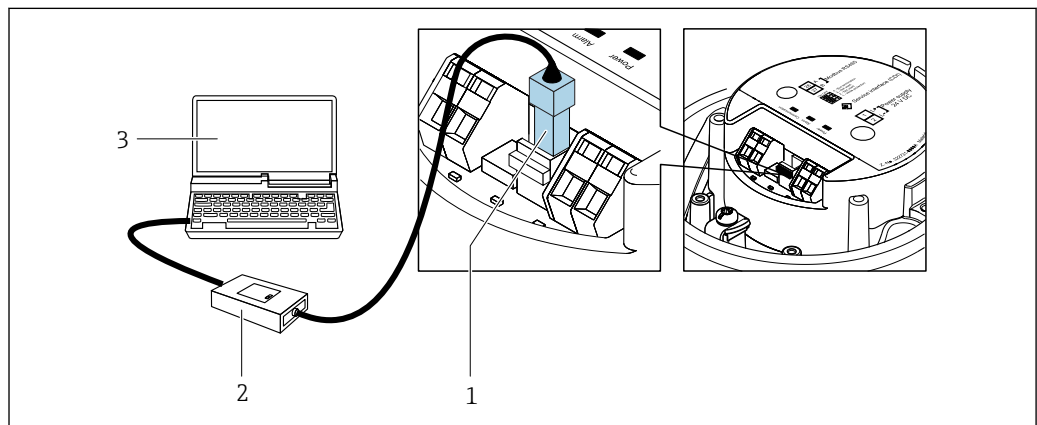

- 1 Service interface (CDI) of measuring device
- 2 Commubox FXA291
- 3 Computer with "FieldCare" operating tool with COM DTM "CDI Communication FXA291"

A0030216

Languages	Can be operated in the following languages: Via "FieldCare" operating tool: English, German, French, Spanish, Italian, Chinese, Japanese
-----------	---

16.12 Certificates and approvals

CE mark	The measuring system is in conformity with the statutory requirements of the applicable EU Directives. These are listed in the corresponding EU Declaration of Conformity along with the standards applied. Endress+Hauser confirms successful testing of the device by affixing to it the CE mark.
C-Tick symbol	The measuring system meets the EMC requirements of the "Australian Communications and Media Authority (ACMA)".
Ex approval	The devices are certified for use in hazardous areas and the relevant safety instructions are provided in the separate "Safety Instructions" (XA) document. Reference is made to this document on the nameplate.
Pressure Equipment Directive	<ul style="list-style-type: none"> ■ With the identification PED/G1/x (x = category) on the sensor nameplate, Endress+Hauser confirms conformity with the "Essential Safety Requirements" specified in Appendix I of the Pressure Equipment Directive 2014/68/EC. ■ Devices not bearing this marking (PED) are designed and manufactured according to good engineering practice. They meet the requirements of Art. 4, Par. 3 of the Pressure Equipment Directive 2014/68/EU. The range of application is indicated in tables 6 to 9 in Annex II of the Pressure Equipment Directive 2014/68/EC.
Other standards and guidelines	<ul style="list-style-type: none"> ■ EN 60529 Degrees of protection provided by enclosures (IP code) ■ EN 61010-1 Safety requirements for electrical equipment for measurement, control and laboratory use - general requirements ■ IEC/EN 61326 Emission in accordance with Class A requirements. Electromagnetic compatibility (EMC requirements). ■ NAMUR NE 21 Electromagnetic compatibility (EMC) of industrial process and laboratory control equipment ■ NAMUR NE 32 Data retention in the event of a power failure in field and control instruments with microprocessors ■ NAMUR NE 43 Standardization of the signal level for the breakdown information of digital transmitters with analog output signal. ■ NAMUR NE 53 Software of field devices and signal-processing devices with digital electronics ■ NAMUR NE 105 Specifications for integrating fieldbus devices in engineering tools for field devices ■ NAMUR NE 107 Self-monitoring and diagnosis of field devices ■ NAMUR NE 131 Requirements for field devices for standard applications

16.13 Application packages

Many different application packages are available to enhance the functionality of the device. Such packages might be needed to address safety aspects or specific application requirements.

The application packages can be ordered with the device or subsequently from Endress+Hauser. Detailed information on the order code in question is available from your local Endress+Hauser sales center or on the product page of the Endress+Hauser website: www.endress.com.



Cleaning

Package	Description
Electrode cleaning circuit (ECC)	The electrode cleaning circuit (ECC) function has been developed to have a solution for applications where magnetite (Fe ₃ O ₄) deposits frequently occur (e.g. hot water). Since magnetite is highly conductive this build up leads to measuring errors and ultimately to the loss of signal. The application package is designed to AVOID build up of highly conductive matter and thin layers (typical of magnetite).

Heartbeat Technology

Package	Description
Heartbeat Verification +Monitoring	<p>Heartbeat Verification Meets the requirement for traceable verification to DIN ISO 9001:2008 Chapter 7.6 a) "Control of monitoring and measuring equipment".</p> <ul style="list-style-type: none"> ▪ Functional testing in the installed state without interrupting the process. ▪ Traceable verification results on request, including a report. ▪ Simple testing process via local operation or other operating interfaces. ▪ Clear measuring point assessment (pass/fail) with high test coverage within the framework of manufacturer specifications. ▪ Extension of calibration intervals according to operator's risk assessment. <p>Heartbeat Monitoring Continuously supplies data, which are characteristic of the measuring principle, to an external condition monitoring system for the purpose of preventive maintenance or process analysis. These data enable the operator to:</p> <ul style="list-style-type: none"> ▪ Draw conclusions - using these data and other information - about the impact process influences (such as corrosion, abrasion, buildup etc.) have on the measuring performance over time. ▪ Schedule servicing in time. ▪ Monitor the process or product quality, e.g. gas pockets.

16.14 Accessories

 Overview of accessories available for order →  77

16.15 Supplementary documentation

 For an overview of the scope of the associated Technical Documentation, refer to the following:

- The *W@M Device Viewer* : Enter the serial number from the nameplate (www.endress.com/deviceviewer)
- The *Endress+Hauser Operations App*: Enter the serial number from the nameplate or scan the 2-D matrix code (QR code) on the nameplate.

Standard documentation

Brief Operating Instructions

 Brief Operating Instructions containing all the important information for standard commissioning is enclosed with the device.

Operating Instructions

Measuring device	Documentation code				
	HART	PROFIBUS DP	Modbus RS485	EtherNet/IP	PROFINET
Promag E 100	BA01305D	BA01307D	BA01306D	BA01308D	BA01423D

Description of device parameters

Measuring device	Documentation code				
	HART	PROFIBUS DP	Modbus RS485	EtherNet/IP	PROFINET
Promag 100	GP01038D	GP01039D	GP01040D	GP01041D	GP01042D

Supplementary device-dependent documentation



Safety Instructions

Contents	Documentation code
ATEX/IECEX Ex nA	XA01090D

Special Documentation

Contents	Documentation code
Information on the Pressure Equipment Directive	SD01056D
Modbus RS485 Register Information	SD01148D
Heartbeat Technology	SD01149D

Installation Instructions

Contents	Comment
Installation instructions for spare part sets and accessories	<ul style="list-style-type: none"> ▪ Access the overview of all the available spare part sets via <i>W@M Device Viewer</i> →  75 ▪ Accessories available for order with Installation Instructions →  77

Index

A

Adapters	21
Adapting the diagnostic behavior	66
Ambient temperature	
Influence	85
Ambient temperature range	20
Application	79
Applicator	79
Approvals	93
Auto scan buffer	
see Modbus RS485 Modbus data map	

C

C-Tick symbol	93
Cable entries	
Technical data	84
Cable entry	
Degree of protection	36
CE mark	9, 93
Certificates	93
Checklist	
Post-connection check	37
Post-installation check	27
Cleaning	
Exterior cleaning	74
Interior cleaning	74
Commissioning	48
Advanced settings	54
Configuring the measuring device	48
Conductivity	86
Configuring error response mode, Modbus RS485	66
Connecting cable	29
Connecting the measuring device	32
Connection	
see Electrical connection	
Connection examples, potential equalization	34
Connection preparations	32
Connection tools	29
Current consumption	83

D

Declaration of Conformity	9
Degree of protection	36, 85
Design	
Measuring device	11
Designated use	8
Device components	11
Device description files	44
Device documentation	
Supplementary documentation	7
Device locking, status	59
Device name	
Sensor	14
Transmitter	13
Device repair	75
Device revision	44

Device type ID	44
DeviceCare	43
Diagnostic information	
Communication interface	65
Design, description	65
DeviceCare	64
FieldCare	64
Light emitting diodes	64
Overview	66
Remedial measures	66
Diagnostic list	69
DIP switches	
see Write protection switch	
Disabling write protection	57
Display values	
For locking status	59
Disposal	76
Document	
Function	5
Symbols used	5
Document function	5
Down pipe	18

E

ECC	55
Electrical connection	
Commubox FXA291	40, 41, 92
Degree of protection	36
Measuring device	29
Operating tools	
Via service interface (CDI)	40, 41, 92
Electromagnetic compatibility	86
Enabling write protection	57
Endress+Hauser services	
Maintenance	74
Repair	75
Environment	
Ambient temperature	20
Impact resistance	86
Mechanical load	86
Shock resistance	86
Storage temperature	85
Vibration resistance	86
Error messages	
see Diagnostic messages	
Event list	69
Event logbook	69
Ex approval	93
Extended order code	
Sensor	14
Transmitter	13
Exterior cleaning	74

F

Field of application	
Residual risks	9

FieldCare	41	Maintenance tasks	74
Device description file	44	Replacing seals	74
Establishing a connection	42	Manufacturer ID	44
Function	41	Manufacturing date	13, 14
User interface	43	Materials	90
Filtering the event logbook	70	Maximum measured error	84
Firmware		Measured values	
Release date	44	Calculated	79
Version	44	Measured	79
Firmware history	73	see Process variables	
Fitted electrodes	92	Measuring and test equipment	74
Flow direction	19	Measuring device	
Flow limit	87	Configuration	48
Function check	48	Conversion	75
Function codes	44	Design	11
Functions		Disposal	76
see Parameter		Integrating via communication protocol	44
G		Mounting the sensor	22
Galvanic isolation	82	Mounting the ground cable/ground disks	23
H		Mounting the seals	23
Hardware write protection	57	Screw tightening torques	23
I		Preparing for electrical connection	32
I/O electronics module	11, 32	Preparing for mounting	22
Identifying the measuring device	12	Removing	76
Impact resistance	86	Repairs	75
Incoming acceptance	12	Measuring principle	79
Influence		Measuring range	79
Ambient temperature	85	Measuring system	79
Information on the document	5	Measuring tube specification	90
Inlet runs	19	Mechanical load	86
Input	79	Medium temperature range	86
Inspection		Menu	
Installation	27	Diagnostics	68
Received goods	12	Operation	59
Inspection check		Setup	48
Connection	37	Menus	
Installation	18	For measuring device configuration	48
Installation conditions		For specific settings	54
Adapters	21	Modbus RS485	
Down pipe	18	Configuring error response mode	66
Inlet and outlet runs	19	Diagnostic information	65
Installation dimensions	20	Function codes	44
Mounting location	18	Modbus data map	46
Orientation	19	Read access	44
Partially filled pipe	18	Reading out data	47
System pressure	20	Register addresses	45
Vibrations	21	Register information	45
Installation dimensions	20	Response time	46
Interior cleaning	74	Scan list	46
L		Write access	44
Languages, operation options	93	Mounting dimensions	
Low flow cut off	82	see Installation dimensions	
M		Mounting location	18
Main electronics module	11	Mounting preparations	22
		Mounting tools	22
		N	
		Nameplate	
		Sensor	14

Transmitter	13	R	
O		Reading measured values	59
Operable flow range	80	Reading out diagnostic information, Modbus RS485	65
Operating menu		Recalibration	74
Menus, submenus	39	Reference operating conditions	84
Structure	39	Registered trademarks	7
Submenus and user roles	40	Repair of a device	75
Operating philosophy	40	Repairs	75
Operation	59	Notes	75
Operation options	38	Repeatability	84
Operational safety	9	Replacement	
Order code	13, 14	Device components	75
Orientation (vertical, horizontal)	19	Replacing seals	74
Outlet runs	19	Requirements for personnel	8
Output	81	Return	75
Output signal	81	S	
P		Safety	8
Packaging disposal	17	Screw tightening torques	23
Parameter settings		Sensor	
Administration (Submenu)	56	Mounting	22
Communication (Submenu)	50	Serial number	13, 14
Device information (Submenu)	71	Setting the operating language	48
Diagnostics (Menu)	68	Settings	
Electrode cleaning circuit (Submenu)	55	Adapting the measuring device to the process	
Empty pipe detection (Wizard)	53	conditions	61
Low flow cut off (Wizard)	51	Administration	56
Process variables (Submenu)	59	Communication interface	50
Sensor adjustment (Submenu)	54	Device reset	71
Setup (Menu)	48	Electrode cleaning circuit (ECC)	55
Simulation (Submenu)	57	Empty pipe detection (EPD)	53
System units (Submenu)	49	Low flow cut off	51
Totalizer (Submenu)	60	Operating language	48
Totalizer 1 to n (Submenu)	54	Resetting the totalizer	61
Totalizer handling (Submenu)	61	Sensor adjustment	54
Partially filled pipe	18	System units	49
Performance characteristics	84	Tag name	48
Post-connection check (checklist)	37	Totalizer	54
Post-installation check	48	Totalizer reset	61
Post-installation check (checklist)	27	Shock resistance	86
Potential equalization	34	Signal on alarm	81
Power consumption	83	Software release	44
Power supply failure	83	Spare part	75
Pressure Equipment Directive	93	Spare parts	75
Pressure loss	87	Special connection instructions	36
Pressure tightness	87	Standards and guidelines	93
Pressure-temperature ratings	87	Status signals	65
Process conditions		Storage conditions	16
Conductivity	86	Storage temperature	16
Flow limit	87	Storage temperature range	85
Medium temperature	86	Structure	
Pressure loss	87	Operating menu	39
Pressure tightness	87	Submenu	
Process connections	92	Administration	56
Product safety	9	Advanced setup	54
Protecting parameter settings	57	Communication	50
		Device information	71
		Electrode cleaning circuit	55
		Event list	69

Measured values	59	Low flow cut off	51
Overview	40	Workplace safety	9
Process variables	59	Write protection	
Sensor adjustment	54	Via write protection switch	57
Simulation	57	Write protection switch	57
System units	49		
Totalizer	60		
Totalizer 1 to n	54		
Totalizer handling	61		
Supplementary documentation	94		
Supply voltage	83		
Surface roughness	92		
System design			
Measuring system	79		
see Measuring device design			
System integration	44		
System pressure	20		
T			
Technical data, overview	79		
Temperature measurement response time	85		
Temperature range			
Storage temperature	16		
Terminal assignment	30, 32		
Terminals	83		
Tools			
Electrical connection	29		
For mounting	22		
Transport	16		
Transmitter			
Connecting the signal cables	32		
Turning the display module	27		
Transporting the measuring device	16		
Troubleshooting			
General	63		
Turning the display module	27		
U			
Use of the measuring device			
Borderline cases	8		
Incorrect use	8		
see Designated use			
User interface			
Current diagnostic event	68		
Previous diagnostic event	68		
User roles	40		
V			
Version data for the device	44		
Vibration resistance	86		
Vibrations	21		
W			
W@M	74, 75		
W@M Device Viewer	12, 75		
Weight			
Compact version	89		
Transport (notes)	16		
Wizard			
Empty pipe detection	53		

www.addresses.endress.com
