



SMARTPAT PH 2390 Technical Datasheet

Digital pH sensor for the wastewater industry

- 2-wire loop powered sensor with integrated transmitter technology
- Special sensor design for harsh applications
- Low maintenance cost and long service cycle

HART 
COMMUNICATION PROTOCOL

1	Product features	3
<hr/>		
1.1	SMARTPAT pH sensor	3
1.2	Design and options	4
1.3	pH measurement.....	6
2	Technical data	8
<hr/>		
2.1	Technical data.....	8
2.2	Dimensions	10
3	Installation	11
<hr/>		
3.1	General notes on installation	11
3.2	Intended use	11
3.3	Pre-installation requirements	12
3.4	Installing the sensor.....	13
3.4.1	General installation instructions.....	13
4	Electrical connections	14
<hr/>		
4.1	Safety instructions.....	14
4.2	Connecting the cable to the sensor	14
4.3	Connecting the sensor cable.....	15
4.3.1	Connection diagram.....	15
5	Order information	18
<hr/>		
5.1	Order code	18
5.2	Consumables and accessories.....	19

1.1 SMARTPAT pH sensor

SMARTPAT analytical sensors from KROHNE are the first and only sensor line in the market with integrated transmitter technology. The complete circuitry is miniaturised and fits into the sensor head. This technical achievement cuts the price in half compared to all measurement systems without integrated transmitter technology.

KROHNE is the only company who offers a real open standard without additional external transmitter and with a direct connection via standardised fieldbus from the sensor to the process control system. The SMARTPAT sensor stores all data and sends these as bidirectional digital signals with 4...20 mA / HART® 7 protocol to the control and asset management systems, handhelds, PC and other peripherals.

The SMARTPAT PH 2390 meets all requirements of the wastewater industries.



- ① Cable connector VarioPin 2.0 (VP2)
- ② Ryton® body
- ③ Diaphragm
- ④ Membrane glass

Highlights

- Large PTFE diaphragm for reliable pH measurement
- Double junction for extended lifetime and a wide application range
- Low maintenance - high potential of cost saving with offline calibration under controlled conditions
- With integrated Pt1000 and standard VP2 connector

Industries

- Industrial wastewater
- Municipal wastewater
- Water

Applications

- Monitoring of surface and wastewater
- Control of biology in wastewater
- Neutralisation in municipal wastewater
- Process control
- Dosage of flocculation agents
- Oily and greasy media

1.2 Design and options



The sensor type is equipped with a large PTFE diaphragm, Pt1000 and is available with Ryton® body material.

The sensor can be easily adapted to various application requirements and can be installed directly into a pipe or tank with the 3/4" MNPT process connection.

The sensor can be integrated into the process control system via PACTware™ (FDT/DTM) with the open standard in fieldbus systems - HART®. The SMARTPAT PH 2390 sensor is compatible with all 2-wire loop powered displays.

Made to Fit

Mounting assemblies SENSOFIT series

As a complete provider for water analysis, we naturally offer a complete range of assemblies, like retractable, immersion and flow-through assemblies in a wide range of materials. Special versions for special operating conditions are available on request.

For the SMARTPAT PH 2390 sensor type the following individual assemblies are available:

- SENSOFIT IMM 2000 series - Immersion assemblies

For further information please consider the technical datasheets.

1.3 pH measurement

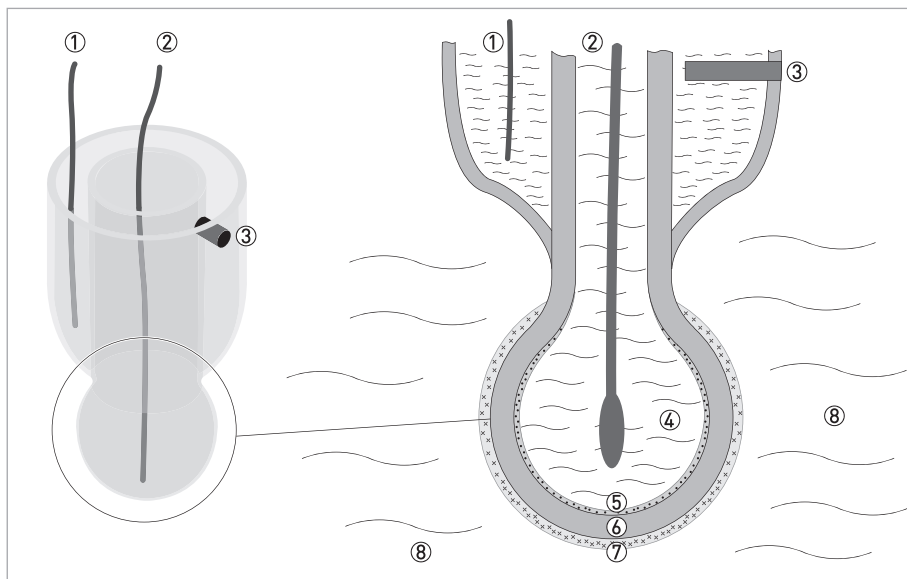

Figure 1-1: Measuring principle for pH measurement

- ① Reference electrode
- ② Measuring electrode
- ③ Diaphragm in contact with KCl solution and measuring medium
- ④ Inner pH 7 buffer solution
- ⑤ Surface potential on the inside [contact with buffer solution]
- ⑥ pH sensitive glass (membrane glass)
- ⑦ Surface potential on the outside [contact with measuring medium]
- ⑧ Measuring medium

The measuring principle of a pH sensor is based on a pH sensitive glass (membrane glass). When the pH sensitive glass gets into contact with a liquid, a thin layer of hydrated gel develops on the surface, enabling an ion exchange between the glass surface and the liquid. The so-called Nernst potential builds up on the glass surface. If both sides of the glass are in contact with liquids, a voltage may be detected between the two surface potentials. The voltage correlates to the difference in H^+ ion concentration and thus to the difference of pH values in both liquids.

The pH sensor contains an internal buffer solution with a known pH value. If the pH value of the measuring medium on the outside of the sensor is equal to the pH value of the inner buffer, the resulting voltage is 0 V.

If the pH value of the medium differs from the internal pH value, a voltage between the internal and the external layer can be measured. From the resulting voltage, the pH difference of the two liquids can be calculated.

The voltage is measured using a measuring electrode and a reference electrode; both are built into the sensor. The measuring electrode is in contact with the known buffer solution in the pH sensitive glass bulb. The reference electrode is immersed into a saturated solution of potassium chloride (KCl). The KCl solution itself is in electrical contact with the measuring medium by means of a diaphragm. The diaphragm prevents the measuring medium from penetrating into the reference system but still allows electrical contact with the measuring medium.

The voltage change of a pH sensor at 25°C / 77°F is around -59 mV for each pH unit. This is also called the slope of the pH sensor. The slope is temperature dependent and decreases over life time of the sensor.

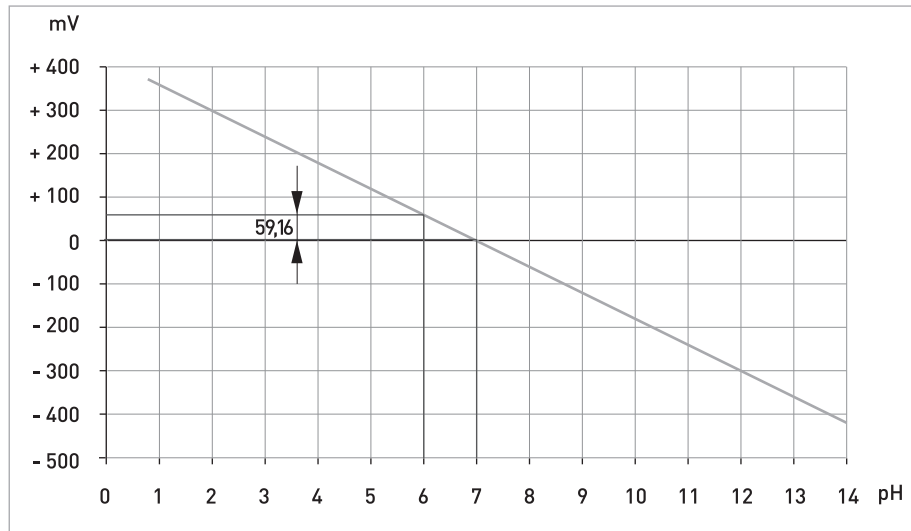

Figure 1-2: Optimal slope at 25°C / 77°F

To compensate for the temperature dependency of the pH measurement, the temperature of the medium can be measured and automatically compensated.

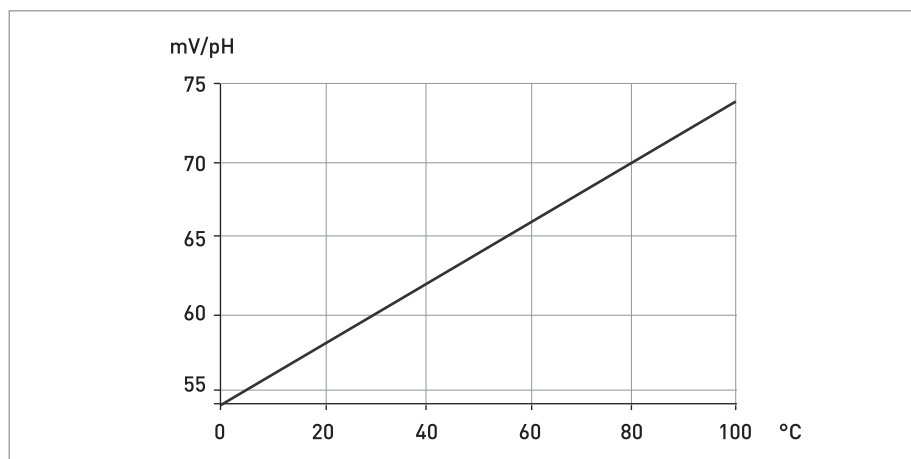

Figure 1-3: Temperature dependency of the Nernst Factor (theoretical slope of a pH sensor)

2.1 Technical data

- *The following data is provided for general applications. If you require data that is more relevant to your specific application, please contact us or your local sales office.*
- *Additional information (certificates, special tools, software,...) and complete product documentation can be downloaded free of charge from the website (Downloadcenter).*

Measuring system

Measuring principle	Potentiometric
Measuring range	0...14 pH

Design

Shaft diameter	20 mm / 0.79"
Insertion length	23 mm / 0.91"
Temperature sensor	Pt1000
Connector	VarioPin 2.0 (VP2)

Operating conditions

Process temperature	0...+80°C / +32...+176°F
Ambient temperature	-10...+85°C / +14...+185°F
Storage temperature	4...+30°C / +40...+86°F
Process pressure	Max. 5.9 bar at +60°C / 85 psi at +140°F
Conductivity	> 150 µS/cm

Installation conditions

Ingress protection	IP68
Weight	Approx. 193 g / 0.43 lb
Process connection	3/4-14 NPT (male)

Materials

Sensor shaft	Ryton®
Membrane glass	Multi purpose glass
Inner buffer	pH 7.0
Reference	KCl gel double junction
Diaphragm	PTFE
Sensor head	Nickel plated brass body with VP2 connector

Communication

pH range	0...14 pH
Resolution pH range	0.01 pH
Output signal	4...20 mA (passive)
Output resolution	20 µA
Field communication	HART® 7 - FSK 1200 physical layer definition on top of the current loop
Time constant	1...60 seconds

Electrical connections

Power supply	15...30 VDC loop powered
Measuring range	4...20 mA + HART® protocol
Load	Minimum 0 Ω; maximum $R_L = ((U_{ext.} - 15 \text{ VDC}) / 22 \text{ mA})$
Error signal	Acc. to NAMUR NE 43
	Upper value: $\geq 21.0 \text{ mA}$
HART®	HART® protocol via current output
Device revision	1
Physical layer	FSK
Device category	Sensor, galvanically isolated
System requirements	250 Ω loop resistance for HART® communication
Multidrop operation	4 mA In a multidrop communication system, up to 32 devices can be connected. For installation in a multidrop communication system please consider the voltage drop for the 250 Ω loop resistance for HART® communication. The supply voltage has to be adjusted.

Approvals

CE	This device fulfils the statutory requirements of the EC directives. The manufacturer certifies successful testing of the product by applying the CE mark.
Shock resistance:	IEC 60068-2-31, Environmental testing – Part 2: Test Ec
Electromagnetic compatibility:	Acc. to EN 61326, NAMUR NE 21 EMC Directive 2004/108/EC (valid until 2016/04/19) or EMC Directive 2014/30/EU (valid from 2016/04/20)

For further information contact your local sales office.

2.2 Dimensions

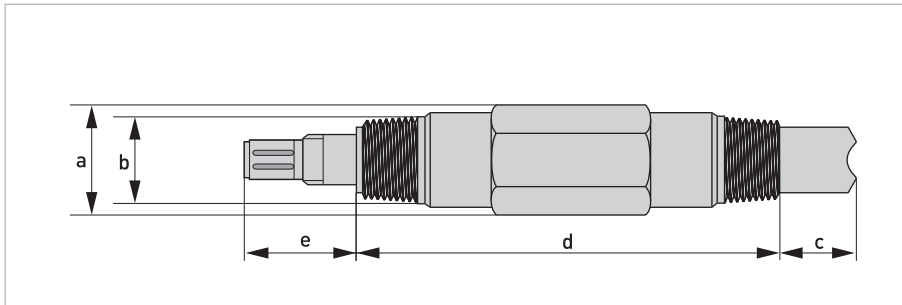

Figure 2-1: SMARTPAT PH 2390 with VP2

	Dimensions [mm]	Dimensions [inch]
a	Ø 33	Ø 1.3
b	3/4" MNPT	
c	24	0.94
d	128	5.04
e	34	1.34

3.1 General notes on installation

For devices used in hazardous areas, additional safety notes apply; please refer to the Ex documentation.

All work on the electrical connections may only be carried out with the power disconnected.

Observe the national regulations for electrical installations!

During installation of the device make sure that you use ESD (electrostatic discharge) protection equipment.

Observe without fail the local occupational health and safety regulations. Any work done on the electrical components of the measuring device may only be carried out by properly trained specialists.

Inspect the packaging carefully for damages or signs of rough handling. Report damage to the carrier and to the local office of the manufacturer.

Do a check of the packing list to make sure that you have all the elements given in the order.

Look at the device nameplate to ensure that the device is delivered according to your order.

3.2 Intended use

Responsibility for the use of the measuring devices with regard to suitability, intended use and corrosion resistance of the used materials against the measured fluid lies solely with the operator.

The manufacturer is not liable for any damage resulting from improper use or use for other than the intended purpose.

The intended use of the sensor SMARTPAT PH 2390 is the measurement of pH in liquids.

3.3 Pre-installation requirements

- *Do not drop the device! Handle the device with care!*
- *Never touch or scratch the pH membrane glass of the sensor.*
- *Store the sensor in its original packaging in a dry, dust-free location. Keep it away from dirt. If necessary, clean it as described in the manual of the sensor.*
- *Do not make any mechanical modifications to the sensor (electrodes shortened, drilled, bent or scratched). This can result in the loss of proper functionality, as well as the rights under the device warranty.*
- *The sensor must be suitable for the temperature, pressure and medium conditions which are specified (including chemical resistance).*

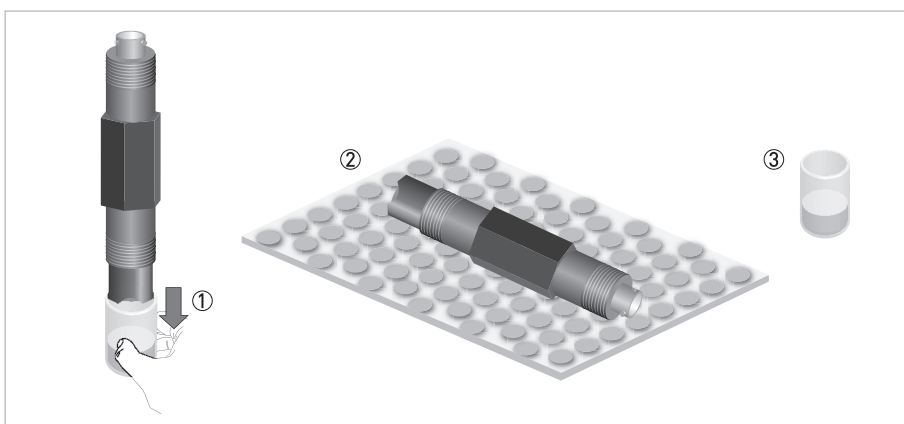

Figure 3-1: Unpacking the sensor

Unpacking the sensor

- Gently pull the protection cap from the sensor ①.
- Lay the sensor on a soft mat/tissue ②.
- Keep the protection cap in the original packaging ③.

3.4 Installing the sensor

3.4.1 General installation instructions

The sensor tip must always have full contact with the measuring medium.

The mounting position of the sensor should not deviate more than 75° from vertical position (sensor tip pointing downwards). Doing otherwise might cause internal air bubbles to float into the sensor tip. This would interrupt the electrical contact between the inner buffer solution and the glass surface.

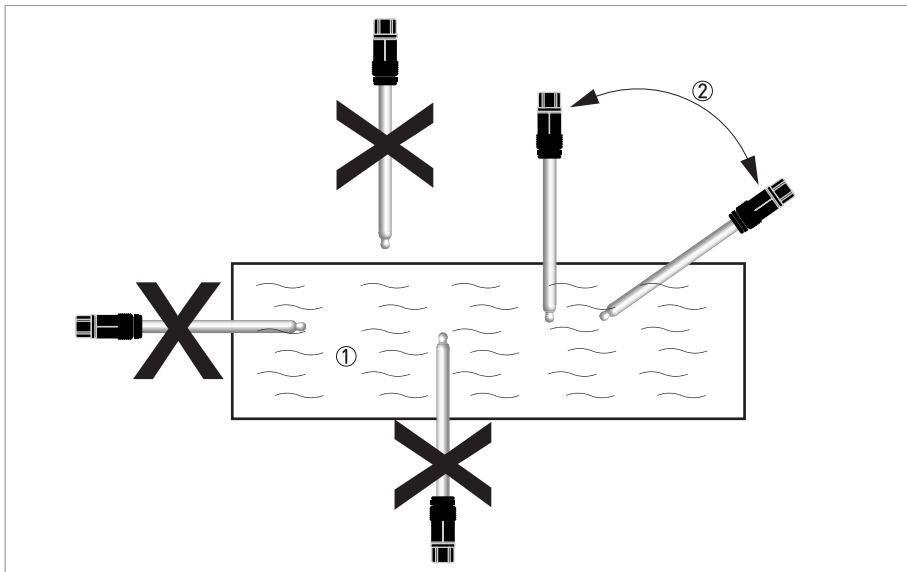

Figure 3-2: Installation requirements

- ① Measuring medium
- ② Maximum deviation of 75° from vertical position

4.1 Safety instructions

All work on the electrical connections may only be carried out with the power disconnected. Take note of the voltage data on the nameplate!

Observe the national regulations for electrical installations!

Observe without fail the local occupational health and safety regulations. Any work done on the electrical components of the measuring device may only be carried out by properly trained specialists.

Look at the device nameplate to ensure that the device is delivered according to your order. Check for the correct supply voltage printed on the nameplate.

4.2 Connecting the cable to the sensor

During installation of the device make sure that you use ESD (electrostatic discharge) protection equipment.

Moisture on the sensor connector must be avoided! Moisture may cause a short-circuit and a malfunction of the sensor!

If moisture has entered the connector dry it with air (e.g. hot air gun).

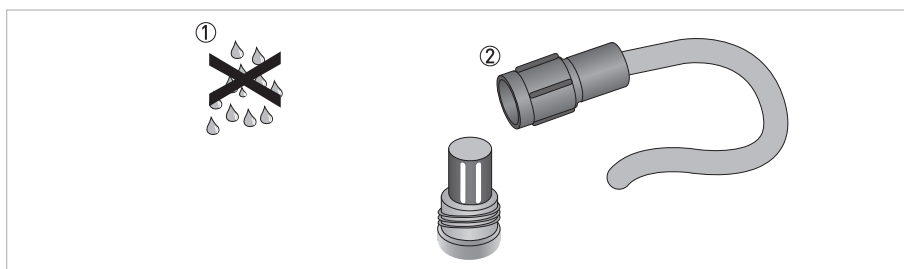

Figure 4-1: Connecting the cable to the sensor

Connecting the cable to the sensor

- Ensure that both cable and sensor connector are absolutely dry ①.
- Screw the cable connector ② on the sensor connector and tighten it by hand.

4.3 Connecting the sensor cable

All work on the electrical connections may only be carried out with the power disconnected.

The cable glands installed by the manufacturer are designed for a cable diameter of 8 mm... 13 mm / 0,31"...0,51". If you are using cables with a larger diameter, you must replace the manufacturer's cable glands with suitable ones. The operator is responsible for the correct sealing of cable glands.

Cable VP2-S

Transparent-black (inner coax shield)	Ub+
White	Ub-
Shield	S

4.3.1 Connection diagram

Connection to SJB 200 W-Ex

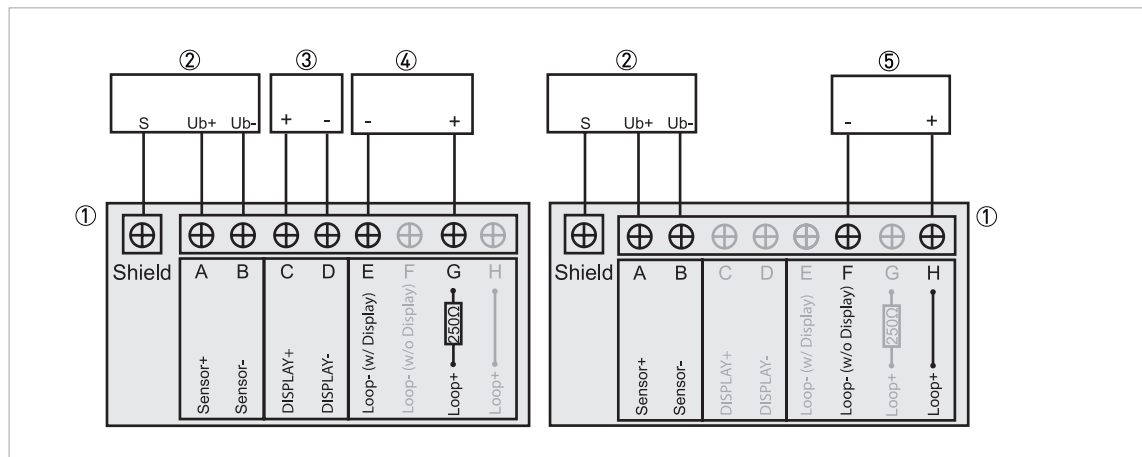

Figure 4-2: Example of a connection with a SJB 200 W-Ex junction box

- ① SJB 200 W-Ex junction box with or without internal resistor used
- ② Sensor with VP2-S cable
- ③ Display or other 4...20 mA loop powered device (e.g. data logger)
- ④ Control system without internal 250 Ω resistor connected to internal resistor of SJB 200 W-Ex
- ⑤ Control system with internal 250 Ω resistor connected to SJB 200 W-Ex without using internal resistor

SJB 200 W-Ex with internal resistor		SJB 200 W-Ex without internal resistor	
S	Shield	S	Shield
A	Sensor +	A	Sensor +
B	Sensor -	B	Sensor -
C	Display +	F	Loop - w/o Display
D	Display -	H	Loop +
E	Loop - w/ Display		
G	Loop + [250Ω]		

HART® interface within SJB 200 W

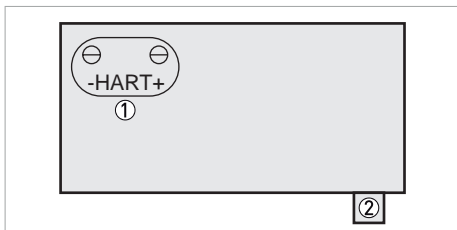

Figure 4-3: Example of a HART® handheld connection

- ① Connection via crocodile clips
- ② **Only for Ex:** M12 connector for the HART® handheld connecting cable

Connection of SMARTMAC 200 W with loop powered device via optional SJB 200 W-Ex junction box to a SMARTPAT Sensor.

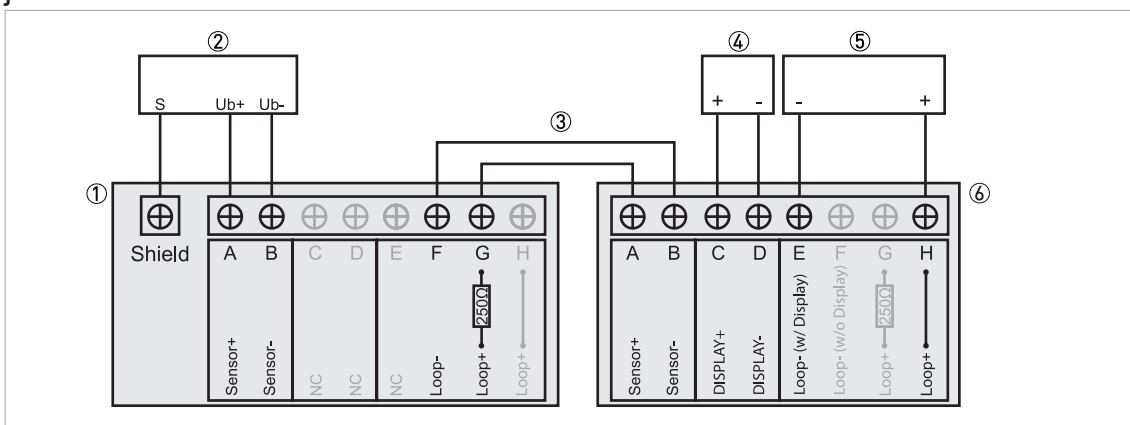

Figure 4-4: Example of connecting the SMARTMAC 200 W to a control system without internal 250 Ω resistor and one additional loop powered device.

- ① SMARTMAC 200 W
- ② Sensor with VP2-S cable
- ③ Cable connection between SJB 200 W-Ex and SMARTMAC 200 W
- ④ Display or other 4...20 mA loop powered device (e.g. data logger)
- ⑤ Control system without internal 250 Ω resistor
- ⑥ SJB 200 W-Ex junction box

SMARTMAC 200 W with internal resistor		SJB 200 W-Ex without internal resistor	
S	Shield	A	Sensor +
A	Sensor +	B	Sensor -
B	Sensor -	C	Display +
F	Loop -	D	Display-
G	Loop + [250Ω]	E	Loop - w/ Display
		H	Loop +

The SJB 200 W offers the opportunity to access the sensor via HART® hand held. For further information refer to the manual of the SJB 200 W.

Connection with sensor and control system

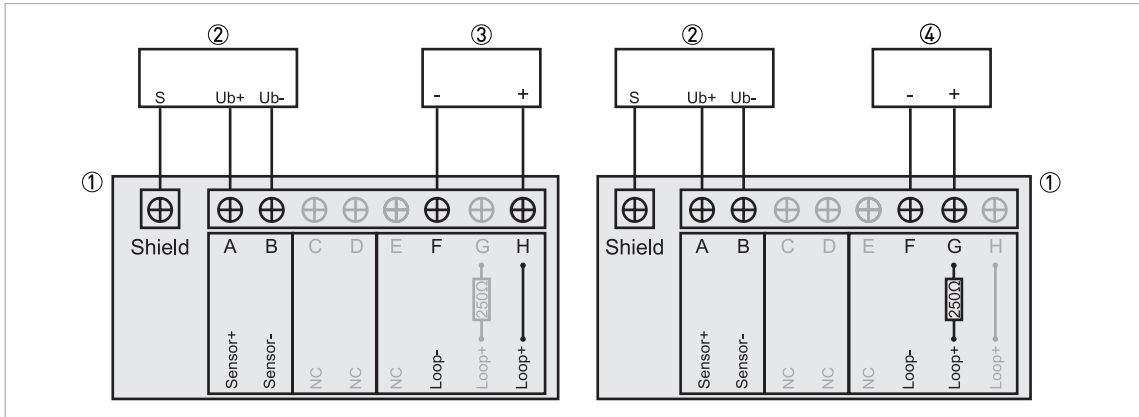

Figure 4-5: SMARTMAC 200 W connection to a control system with internal 250 Ω resistor (left side). SMARTMAC 200 W connection to a control system without internal 250 Ω resistor (right side).

- ① SMARTMAC 200 W
- ② Sensor with VP2-S cable
- ③ Control system with internal 250 Ω resistor
- ④ Control system without internal 250 Ω resistor

SMARTMAC 200 W without internal resistor		SMARTMAC 200 W with internal resistor	
S	Shield	S	Shield
A	Sensor +	A	Sensor +
B	Sensor -	B	Sensor -
F	Loop -	F	Loop -
H	Loop +	G	Loop + [250Ω]

5.1 Order code

The characters of the order code highlighted in light grey describe the standard.

VGS U	4	Sensor type																		
		2	SMARTPAT PH 2390																	
			Diaphragm																	
		3	PTFE																	
			Reference																	
		B	KCl gel double junction																	
			Process conditions																	
		1	0...+80°C, 6.9 bar / +32...+176 °F, 100 psi																	
			Insertion length																	
		A	23 mm / 0.9"																	
			Body material																	
		2	Ryton®																	
			Communication																	
		A	4...20 mA / HART® not suitable for SMARTMAC																	
		B	4...20 mA / HART® (SMARTMAC)																	
			Connector type																	
		4	VP2; Body: nickel-plated brass																	
			Certificates																	
		0	none																	
			Documentation																	
		0	none																	
		2	English																	
		3	German																	
		4	French																	
		5	Spanish																	
		6	Italian																	
		7	Turkish																	
VGS U	4																			

5.2 Consumables and accessories

Accessories	Order code
-------------	------------

Display

SD 200 W - Indicator for SMARTPAT sensors, wall mount	VGSD 4 1A2A20x
SD 200 R - Indicator for SMARTPAT sensors, rack mount	VGSD 4 2A3A00x
F400 (SD 200 W-EX) - Indicator for SMARTPAT sensors, wall mount, Ex	VGSD 4 1A2A2Cx
D400 (SD 200 R-EX) - Indicator for SMARTPAT sensors, rack mount, Ex	VGSD 4 2A3A0Cx

USB interface cable

SMARTBRIDGE - USB interface cable for SMARTPAT sensors	XGA S 080010
FSK USBex - USB interface cable for SMARTPAT sensors, Ex (additional Ex separator required)	XGA S 080015

Junction box

SJB 200 W-Ex - Junction box for connecting sensor with process control system, Ex	XGA S 080013
---	--------------

Cable for SMARTPAT sensors

Consumables	Order code
Cable VP2-S-3 (3 m / 9.84 ft)	XGA W 080130
Cable VP2-S-5 (5 m / 16.4 ft)	XGA W 080140
Cable VP2-S-10 (10 m / 32.8 ft)	XGA W 080150
Cable VP2-S-15 (15 m / 49.2 ft)	XGA W 080160
Cable VP2-S-20 (20 m / 65.6 ft)	XGA W 080170
Cable VP2-S-30 (30 m / 98.4 ft)	XGA W 080180

pH buffer solution to calibrate the sensor

Consumables	Order code
250 ml pH buffer solution pH4	XGA S 010020
250 ml pH buffer solution pH7	XGA S 010030

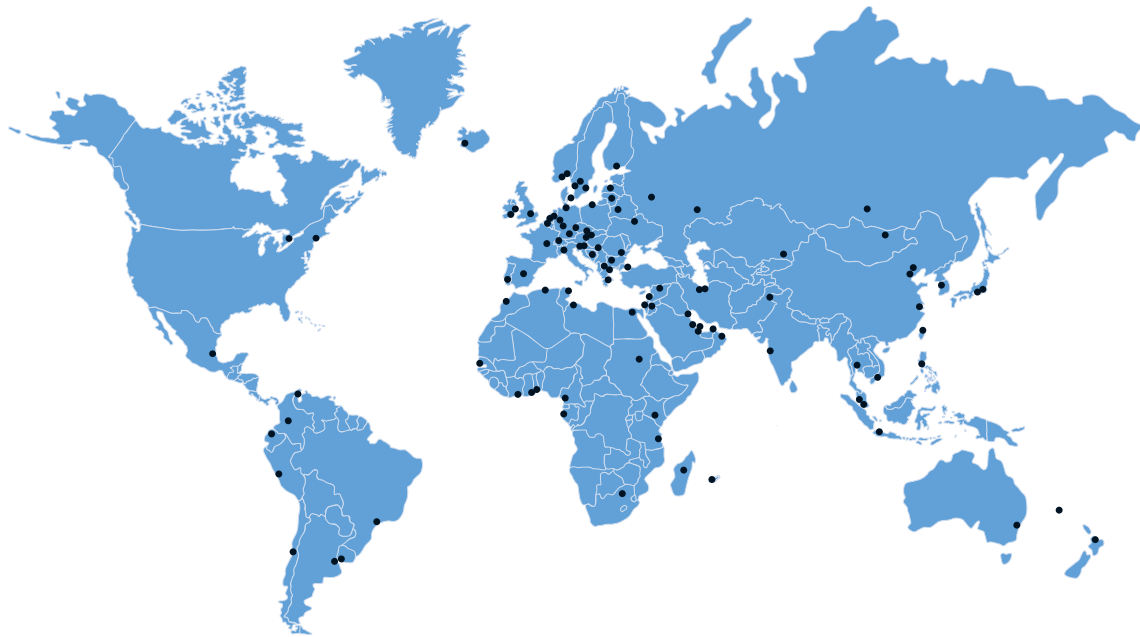

KROHNE – Process instrumentation and measurement solutions

- Flow
- Level
- Temperature
- Pressure
- Process Analysis
- Services

Head Office KROHNE Messtechnik GmbH
Ludwig-Krohne-Str. 5
47058 Duisburg (Germany)
Tel.: +49 203 301 0
Fax: +49 203 301 10389
info@krohne.com

The current list of all KROHNE contacts and addresses can be found at:
www.krohne.com

KROHNE