



INSTRUCTION & SAFETY MANUAL

10 A SIL 3 Relay Output Module for ND Load,
with ND or NE Relay condition
DIN-Rail and Termination Board, Model D5291S



Characteristics

General Description: The single channel Relay Output, D5291S is a relay module suitable for the switching of safety related circuits, up to SIL 3 level according to IEC 61508:2010 Ed.2 for high risk industries. It provides isolation between input and output contacts.

Two mutually exclusive (by DIP-Switch programming) monitoring circuits are provided:

- 1) line input monitoring, to allow DCS/PLC line monitoring function: when enabled, the module permits a wide compatibility towards different DCS/PLC. Driving line pulse testing, executed by DCS/PLC, is permitted by a dedicated internal circuit, to prevent relay and LED flickering.
 - 2) low voltage input monitoring: when enabled, the module reflects a high impedance state to the control unit when the driving voltage is below the specified threshold.
- D5291S provides 1 SPDT contact for two different safety functions:
- 1) SIL 3 Safety Function for Normally De-Energized load (energized in fail safe state) is available at Terminal Blocks 13-14. The driving signal is normally low (0 Vdc), the relay is normally de-energized, contact is open and load is de-energized. The safety function is met when the driving signal is high (24 Vdc), the relay is energized, contact is closed and load is energized. At Terminal Blocks 13-15 is also available a service contact (for service load) with opposite (not SIL) function.
 - 2) SIL 3 Safety Function for Normally De-Energized load (energized in fail safe state) is available at Terminal Blocks 13-15. The driving signal is normally high (24 Vdc), the relay is normally energized, contact is open and load is de-energized. The safety function is met when the driving signal is low (0 Vdc), the relay is de-energized, contact is closed and load is energized. At Terminal Blocks 13-14 is also available a service contact (for service load) with opposite (not SIL) function.

This relay module is not suitable for low-current consumption applications (system-to-system signalling, driving LEDs, etc.).

Mounting on standard DIN-Rail or on customized Termination Boards, in Safe Area / Non Hazardous Location or in Zone 2 / Class I, Division 2 or Class I, Zone 2.

Functional Safety Management Certification:

G.M. International is certified by TUV to conform to IEC61508:2010 part 1 clauses 5-6 for safety related systems up to and included SIL3.



Technical Data

Input: 24 Vdc nom (21.6 to 27.6 Vdc) reverse polarity protected, ripple within voltage limits ≤ 5 Vpp.

The following monitoring circuits are mutually exclusive:

- 1) **Line input monitoring (DIP-Switch selectable):** to allow DCS/PLC line monitoring function (pulse test).
- 2) **Voltage monitoring (DIP-Switch selectable):** ≥ 21.6 Vdc for normal operation, ≤ 17 Vdc reflects a high impedance (≤ 10 mA consumption) to the control device.

Current consumption @ 24 V: 60 mA with relay energized, typical.

Power dissipation: 1.5 W with 24 V input voltage and relay energized, typical.

Isolation (Test Voltage): Input/Output 2.5 KV.

Output: voltage free SPDT relay contact.

Terminals 13-14, open when relay de-energized, close in energized condition. Terminals 13-15, close when relay de-energized, open in energized condition.

Contact material: Ag Alloy (Cd free) or AgSnO₂.

Contact rating: 10 A 250 Vac 2500 VA, 10 A 250 Vdc 300 W (resistive load).

Contact inrush current: 16 A at 24 Vdc, 250 Vac.

Contact min. switching current: 100 mA.

Mechanical / Electrical life: $10^6 / 5 \times 10^4$ operation, typical.

Operate / Release time: 40 / 25 ms, typical.

Frequency response: 10 Hz maximum.

Compatibility:

CE mark compliant, conforms to Directive:
2014/34/EU ATEX, 2014/30/EU EMC, 2014/35/EU LVD, 2011/65/EU RoHS.

Environmental conditions:

Operating: temperature limits - 40 to + 60 °C, relative humidity 95 %, up to 55 °C.

Storage: temperature limits - 45 to + 80 °C.

Max altitude: 2000 m a.s.l.

Safety Description:



ATEX: II 3G Ex ec nC IIC T4 Gc; **IECEx / INMETRO:** Ex ec nC IIC T4 Gc

FM: NI / I / 2 / ABCD / T4, I / 2 / AEx nA nC / IIC / T4; **FMC:** NI / I / 2 / ABCD / T4, I / 2 / Ex nA nC / IIC / T4

EAC-EX: 2Ex ec nC IIC T4 Gc X .

CCC: Ex ec nC IIC T4 Gc

non-sparking electrical equipment.

-40 °C \leq Ta \leq 70 °C.

Approvals:

BVS 10 ATEX E 114 conforms to EN60079-0, EN60079-7, EN60079-15.

IECEx BVS 10.0072 X conforms to IEC60079-0, IEC60079-7, IEC60079-15.

INMETRO DNV 13.0109 X conforms to ABNT NBR IEC60079-0, ABNT NBR IEC60079-7, ABNT NBR IEC60079-15.

FM 3046304 and FMC 3046304C conforms to Class 3600, 3611, 3810, ANSI/ISA-60079-0, ANSI/ISA-60079-15, C22.2 No.142, C22.2 No.213, C22.2 No. 60079-0, C22.2 No. 60079-15.

EA3C RU C-IT.AA87.B.01310/24 conforms to GOST 31610.0, GOST 31610.7, GOST 31610.15.

CCC n. 2020322316000978 conforms to GB/T 3836.1, GB/T 3836.3, GB/T 3834.8

TÜV Certificate No. C-IS-236198-04, SIL 2 / SIL 3 conforms to IEC61508:2010 Ed.2.

SIL 3 Functional Safety TÜV Certificate conforms to IEC61508:2010 Ed.2, for Management of Functional Safety.

DNV Type Approval Certificate No. TAA00001U0 and KR No.MIL20769-EL002 Certificates for maritime applications.

Mounting:

EN/IEC60715 TH 35 DIN-Rail or on customized Termination Board.

Weight: about 165 g.

Connection: by polarized plug-in disconnect screw terminal blocks to accommodate terminations up to 2.5 mm².

Location: installation in Safe Area/Non Hazardous Locations or Zone 2, Group IIC T4 or Class I, Division 2, Group A,B,C,D, T4 or Class I, Zone 2, Group IIC, T4.

Protection class: IP 20.

Dimensions: Width 22.5 mm, Depth 123 mm, Height 120 mm.

DC Load breaking capacity:

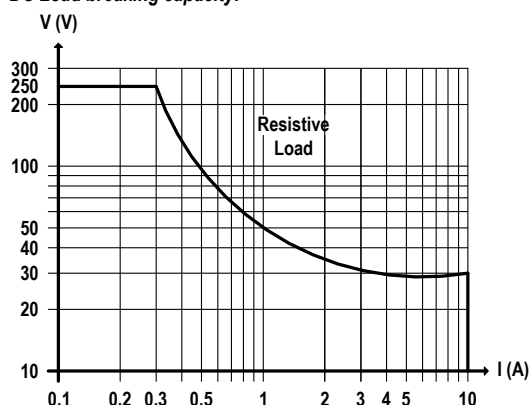

Ordering Information

Model: D5291S

DIN-Rail accessories: Cover and fix MCHP196

Front Panel and Features



- SIL 3 according to IEC 61508:2010 Ed. 2 for Tproof = 6 / 20 yrs ($\leq 10\%$ / $> 10\%$ of total SIF) for ND load with ND relay (terminals 13-14).
- SIL 3 according to IEC 61508:2010 Ed. 2 for Tproof = 14 / 20 yrs ($\leq 10\%$ / $> 10\%$ of total SIF) for ND load with NE relay (terminals 13-15).
- PFDavg (1 year) 1.58 E-05, SFF 96.35 % for ND load with ND relay.
- PFDavg (1 year) 7.01 E-06, SFF 99.17% for ND load with NE relay.
- Systematic capability SIL 3.
- Installation in Zone 2 / Division 2.
- 10 A SPDT contact for 2 different Safety Functions:
 - 1) SIL 3 for ND load (energized in fail safe state) with ND relay condition (energized in fail safe state);
 - 2) SIL 3 for ND load (energized in fail safe state) with NE relay condition (de-energized in fail safe state).
- 16 A inrush current at 24 Vdc / 250 Vac.
- Line input monitoring in-field DIP Switch selectable.
- Driving input voltage monitoring.
- Input/Output isolation.
- EMC Compatibility to EN61000-6-2, EN61000-6-4, EN61326-1, EN61326-3-1 for safety system.
- ATEX, IECEx, FM & FM-C, INMETRO, EAC-EX, CCC, TÜV Certifications.
- TUV Functional Safety Certification.
- Type Approval Certificate DNV and KR for maritime applications.
- Simplified installation using standard DIN-Rail and plug-in terminal blocks or customized Termination Boards.

Terminal block connections

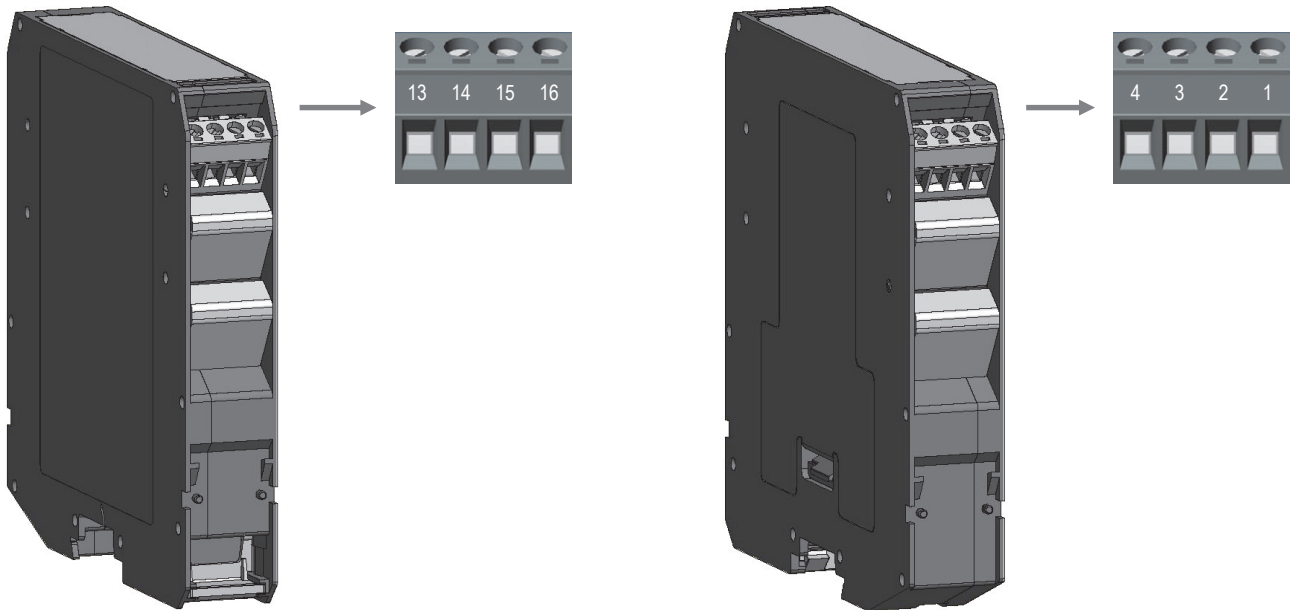

SAFE AREA

<table style="width: 100%;"> <tr> <td style="background-color: #e0f2f1; padding: 5px;">13</td> <td style="padding: 5px;">SPDT Output Common</td> </tr> <tr> <td style="background-color: #e0f2f1; padding: 5px;">14</td> <td style="padding: 5px;">SPDT Output Normally Open Contact</td> </tr> <tr> <td style="background-color: #e0f2f1; padding: 5px;">15</td> <td style="padding: 5px;">SPDT Output Normally Close Contact</td> </tr> <tr> <td style="background-color: #e0f2f1; padding: 5px;">16</td> <td style="padding: 5px;">Not used</td> </tr> </table>	13	SPDT Output Common	14	SPDT Output Normally Open Contact	15	SPDT Output Normally Close Contact	16	Not used	<table style="width: 100%;"> <tr> <td style="background-color: #e0f2f1; padding: 5px;">1</td> <td style="padding: 5px;">+ Input</td> </tr> <tr> <td style="background-color: #e0f2f1; padding: 5px;">2</td> <td style="padding: 5px;">- Input</td> </tr> <tr> <td style="background-color: #e0f2f1; padding: 5px;">3</td> <td style="padding: 5px;">+ Input</td> </tr> <tr> <td style="background-color: #e0f2f1; padding: 5px;">4</td> <td style="padding: 5px;">- Input</td> </tr> </table>	1	+ Input	2	- Input	3	+ Input	4	- Input
13	SPDT Output Common																
14	SPDT Output Normally Open Contact																
15	SPDT Output Normally Close Contact																
16	Not used																
1	+ Input																
2	- Input																
3	+ Input																
4	- Input																

Function Diagram

SAFE AREA, ZONE 2 GROUP IIC T4,
NON HAZARDOUS LOCATIONS, CLASS I, DIVISION 2,
GROUPS A, B, C, D T-Code T4, CLASS I, ZONE 2, GROUP IIC T4

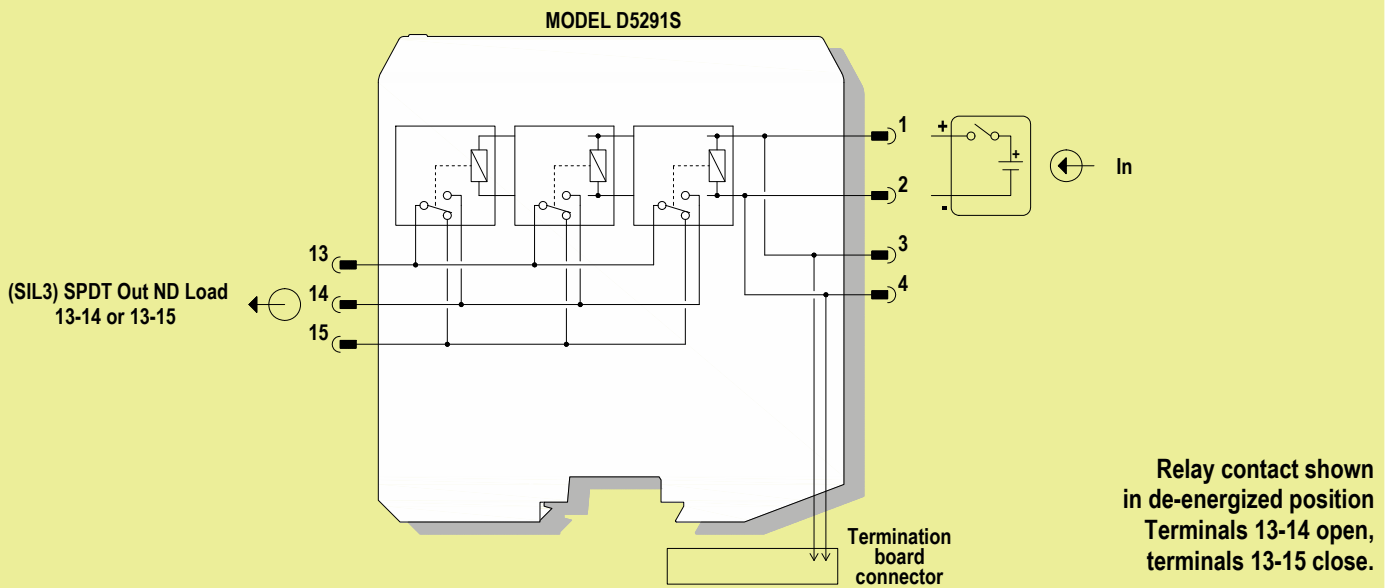

**SIL3 Safety Function for ND load (energized in fail safe state) is available at terminal blocks 13-14;
In this case, the Safety Function is met when the relay is energized (closed contact).**

**SIL3 Safety Function for ND load (energized in fail safe state) is available at terminal blocks 13-15;
In this case, the Safety Function is met when the relay is de-energized (closed contact).**

**To prevent relay contacts from damaging, connect an external protection (fuse or similar),
chosen according to the relay breaking capacity diagram.**

1) Application for D5291S - SIL Load Normally De-Energized Condition (ND) and Normally De-Energized Relay

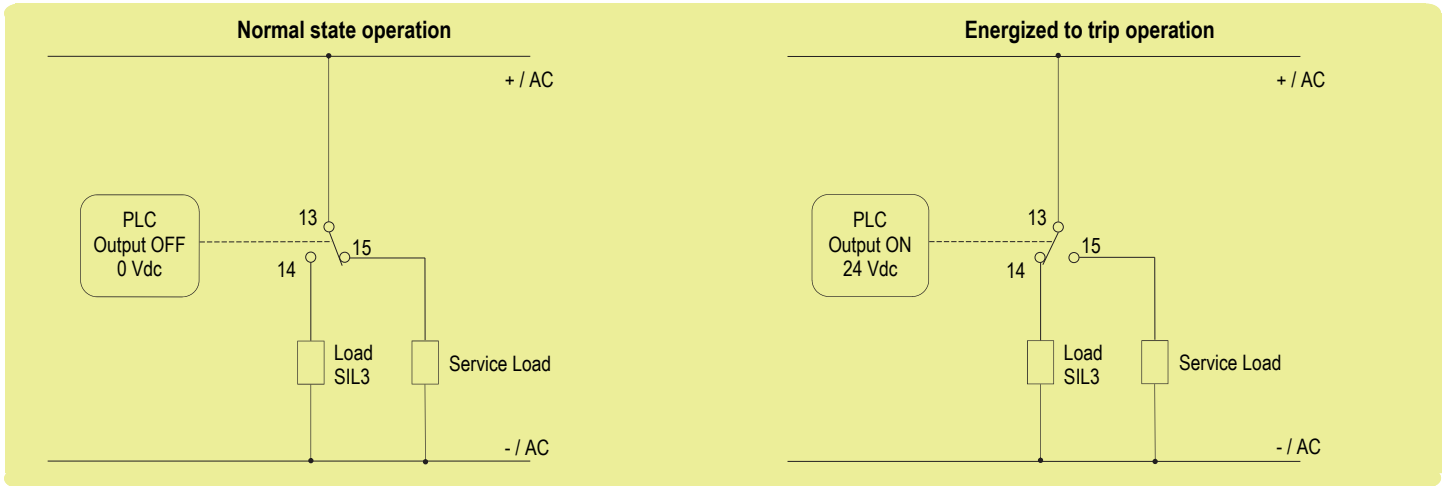

Description:

Input Signal from PLC/DCS is normally Low (0 Vdc) and is applied to pins 1-2 or 3-4 in order to Normally De-Energize (ND) the internal relays. Input Signal from PLC/DCS is High (24 Vdc) during "energized to trip" operation, in order to energize the internal relays. The Load is Normally De-Energized (ND), therefore its safe state is to be energized; the Service Load is normally energized, therefore it de-energizes during "energized to trip" operation. Disconnection of the ND Load is done on only one load supply line. The following table describes the status (open or closed) of each output contact when the input signal is High or Low.

Operation	Input Signal Pins 1-2 or 3-4	Pins 13 - 14	Pins 13 - 15	ND Load (SIL3) Pins 14 — - / AC Supply	Service Load (Not SIL) Pins 15 — - / AC Supply
Normal	Low (0 Vdc)	Open	Closed	De-Energized	Energized
Trip	High (24 Vdc)	Closed	Open	Energized	De-Energized

Safety Function and Failure behavior:

D5291S is considered to be operating in Low Demand mode, as a Type A module, having Hardware Fault Tolerance (HFT) = 0. In the 1st Functional Safety application, the normal state operation of relay module is de-energized, with ND (Normally De-Energized) loads. In case of alarm or request from process, the relay module is energized (safe state), energizing the load. The failure behaviour of the relay module is described by the following definitions:
 □ fail-Safe State: it is defined as the output load being energized;
 □ fail Safe: this failure causes the system to go to the defined fail-safe state without a process demand;
 □ fail Dangerous: failure mode that does not respond to a demand from the process (i.e. being unable to go to the defined fail-safe state) so that the output load remains de-energized;
 □ fail "No effect": failure mode of a component that plays a part in implementing the safety function but is neither a safe failure nor a dangerous failure. When calculating the SFF this failure mode is not taken into account.
 □ fail "Not part": failure mode of a component which is not part of the safety function but part of the circuit diagram and is listed for completeness. When calculating the SFF this failure mode is not taken into account.
 Failure rate data: taken from Siemens Standard SN29500.

Failure rate table:

Failure category	Failure rates (FIT)
λ_{dd} = Total Dangerous Detected failures	0.00
λ_{du} = Total Dangerous Undetected failures	3.64
λ_{sd} = Total Safe Detected failures	0.00
λ_{su} = Total Safe Undetected failures	96.00
$\lambda_{tot\ safe}$ = Total Failure Rate (Safety Function) = $\lambda_{dd} + \lambda_{du} + \lambda_{sd} + \lambda_{su}$	99.64
MTBF (safety function, single channel) = $(1 / \lambda_{tot\ safe}) + MTTR$ (8 hours)	1145 years
$\lambda_{no\ effect}$ = "No effect" failures	302.96
$\lambda_{not\ part}$ = "Not Part" failures	0.00
$\lambda_{tot\ device}$ = Total Failure Rate (Device) = $\lambda_{tot\ safe} + \lambda_{no\ effect} + \lambda_{not\ part}$	402.60
MTBF (device, single channel) = $(1 / \lambda_{tot\ device}) + MTTR$ (8 hours)	283 years
MTTF _S (Total Safe) = $1 / (\lambda_{sd} + \lambda_{su})$	1189 years
MTTF _D (Dangerous) = $1 / \lambda_{du}$	31387 years

Failure rates table according to IEC 61508:2010 Ed.2 :

λ_{sd}	λ_{su}	λ_{dd}	λ_{du}	SFF
0.00 FIT	96.00 FIT	0.00 FIT	3.64 FIT	96.35%

PFDavg vs T[Proof] table (assuming Proof Test coverage of 99%), with determination of SIL supposing module contributes ≤10% of total SIF dangerous failures:

T[Proof] = 1 year	T[Proof] = 6 years
PFDavg = 1.59 E-05 - Valid for SIL 3	PFDavg = 9.57 E-05 - Valid for SIL 3

PFDavg vs T[Proof] table (assuming Proof Test coverage of 99%), with determination of SIL supposing module contributes >10% of total SIF dangerous failures:

T[Proof] = 20 years
PFDavg = 3.19 E-04 - Valid for SIL 3

Systematic capability SIL 3.

2) Application for D5291S - SIL Load Normally De-Energized Condition (ND) and Normally Energized Relay

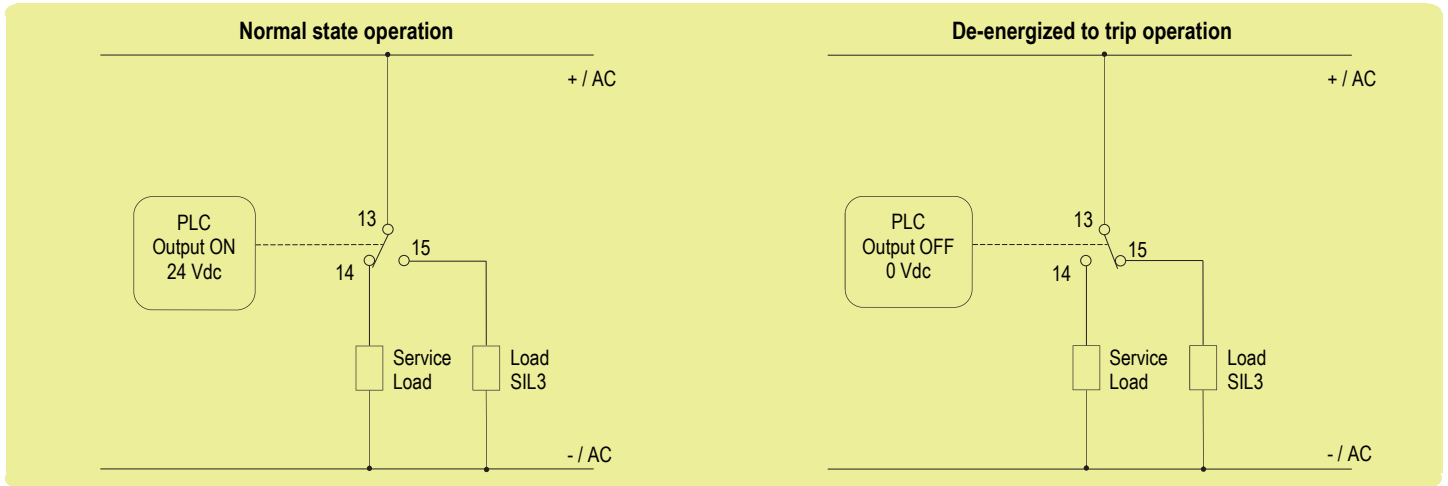

Description:

Input Signal from PLC/DCS is normally High (24 Vdc) and is applied to pins 1-2or 3-4 in order to Normally Energize (NE) the internal relays. Input Signal from PLC/DCS is Low (0 Vdc) during "de-energized to trip" operation, in order to de-energize the internal relays. The Load is Normally De-Energized (ND), therefore its safe state is to be energized; the Service Load is normally energized, therefore it de-energizes during "de-energized to trip" operation. Disconnection of the ND Load is done on only one load line supply. The following table describes the status (open or closed) of each output contact when the input signal is High or Low.

Operation	Input Signal Pins 1-2 or 3-4	Pins 13- 14	Pins 13 - 15	ND Load (SIL3) Pins 15 --- / AC Supply	Service Load (Not SIL) Pins 14 --- / AC Supply
Normal	High (24 Vdc)	Closed	Open	De-Energized	Energized
Trip	Low (0 Vdc)	Open	Closed	Energized	De-Energized

Safety Function and Failure behavior:

D5291S is considered to be operating in Low Demand mode, as a Type A module, having Hardware Fault Tolerance (HFT) = 0. In the 2nd Functional Safety application, the normal state operation of relay module is energized, with ND (Normally De-Energized) load. In case of alarm or request from process, the relay module is de-energized (safe state), energizing the load.

The failure behaviour of the relay module is described by the following definitions:

- fail-Safe State: it is defined as the output load being energized;
- fail Safe: this failure causes the system to go to the defined fail-safe state without a process demand;
- fail Dangerous: failure mode that does not respond to a demand from the process (i.e. being unable to go to the defined fail-safe state), so that the output load remains de-energized.
- fail "No effect": failure mode of a component that plays a part in implementing the safety function but is neither a safe failure nor a dangerous failure; When calculating the SFF this failure mode is not taken into account.
- fail "Not part": failure mode of a component which is not part of the safety function but part of the circuit diagram and is listed for completeness; When calculating the SFF this failure mode is not taken into account.

Failure rate data: taken from Siemens Standard SN29500.

Failure rate table:

Failure category	Failure rates (FIT)
λ_{dd} = Total Dangerous Detected failures	0.00
λ_{du} = Total Dangerous Undetected failures	1.60
λ_{sd} = Total Safe Detected failures	0.00
λ_{su} = Total Safe Undetected failures	191.40
$\lambda_{tot\ safe}$ = Total Failure Rate (Safety Function) = $\lambda_{dd} + \lambda_{du} + \lambda_{sd} + \lambda_{su}$	193.00
MTBF (safety function, single channel) = $(1 / \lambda_{tot\ safe}) + MTTR$ (8 hours)	591 years
$\lambda_{no\ effect}$ = "No effect" failures	209.60
$\lambda_{not\ part}$ = "Not Part" failures	0.00
$\lambda_{tot\ device}$ = Total Failure Rate (Device) = $\lambda_{tot\ safe} + \lambda_{no\ effect} + \lambda_{not\ part}$	402.60
MTBF (device, single channel) = $(1 / \lambda_{tot\ device}) + MTTR$ (8 hours)	283 years
$MTTF_S$ (Total Safe) = $1 / (\lambda_{sd} + \lambda_{su})$	596 years
$MTTF_D$ (Dangerous) = $1 / \lambda_{du}$	71347 years

Failure rates table according to IEC 61508:2010 Ed.2 :

λ_{sd}	λ_{su}	λ_{dd}	λ_{du}	SFF
0.00 FIT	191.40 FIT	0.00 FIT	1.60 FIT	99.17%

PFDavg vs T[Proof] table (assuming Proof Test coverage of 99%), with determination of SIL supposing module contributes ≤10% of total SIF dangerous failures:

T[Proof] = 1 year	T[Proof] = 14 years
PFDavg = 7.01 E-06 - Valid for SIL 3	PFDavg = 9.81 E-05 - Valid for SIL 3

PFDavg vs T[Proof] table (assuming Proof Test coverage of 99%), with determination of SIL supposing module contributes >10% of total SIF dangerous failures:

T[Proof] = 20 years
PFDavg = 1.40 E-04 - Valid for SIL 3

Systematic capability SIL 3.

Testing procedure at T-proof

The proof test shall be performed to reveal dangerous faults which are undetected by diagnostic. This means that it is necessary to specify how dangerous undetected faults, which have been noted during the FMEDA, can be revealed during proof test. The Proof test consists of the following steps:

Steps	Action
1	Bypass the safety-related PLC or take other appropriate action to avoid a false trip when removing the unit for test.
2	<p>For the single channel, verify the input-to-output functionality:</p> <ol style="list-style-type: none"> For De-energized relays and open contacts, terminals "13"-14", the output load is normally de-energized when the input channel is off, while the activation of the input channel energizes the load (safe state). For Energized relays and open contacts, terminals "13"-15", the output load is normally de-energized when the input is supplied, while the shutdown of the input channel energizes the load (safe state). <p>The channel functionality must be verified for a min to max input voltage change (21.6 to 27.6 Vdc). In addition, the use of three relays for the single output channel, where the contacts are connected in parallel, requires to control the single coils by means of DIP-switch (n°1, 3, 5) and to check the ohmic continuity of the contacts, as described in the following procedures.</p> <ol style="list-style-type: none"> Do not supply the input channel (terminals "1"-2" or "3"-4") of the unit under test and verify that the ohmic continuity at the output contact terminals "13"-14" is absent (i.e. the parallel connection of the 3 NO contacts is open: 1st requisite is verified). But this condition could also be true if all contacts are normally open except one, which is blocked (for welding) into open position: this will be verified testing the channel when input is supplied (see 3rd requisite). Instead, the presence of ohmic continuity implies that at least one relay contact is blocked (for welding) into closed position: this could only be verified disassembling and individually testing each relay. Do not supply the input channel (terminals "1"-2" or "3"-4") of the unit under test and verify that the ohmic continuity at the output contact terminals "13"-15" is present (i.e. the parallel connection of the 3 NC contacts is closed: 2nd requisite is verified). But this condition could also be true if only one contact is closed and others are blocked (for welding) into closed or open position: this will be verified testing the channel when input is supplied (see 4th requisite). Instead, the absence of ohmic continuity implies that all relay contacts are blocked (for welding) into open position. Supply the input channel (terminals "1"-2" or "3"-4") of the unit under test and verify that the ohmic continuity at the output contacts (terminals "13"-14") is present (i.e. the parallel connection of the 3 NO contacts is closed: 3rd requisite is verified). The absence of ohmic continuity implies that all relay contacts are blocked (for welding) into open position. Instead, to verify if a single contact is blocked (for welding) into open position, use the DIP-switches (n°1, 3, 5) to short circuit each possible couple among the 3 relay coils (starting with 1st & 2nd coils by DIP-switches n°1 & 3, then going with 1st & 3rd ones by DIP-switches n°1 & 5, and finally proceeding with 2nd & 3rd ones by DIP-switches n°3 & 5), verifying that ohmic continuity is always present between terminals "13"-14". In this situation, the absence of ohmic continuity implies that a relay contact (the only one with energized coil because the others are de-energized) is blocked (for welding) into open position. Supply the input channel (terminals "1"-2" or "3"-4") of the unit under test and verify that the ohmic continuity at the output contacts (terminals "13"-15") is absent (i.e. the parallel connection of the 3 NC contacts is open: 4th requisite is verified). The presence of ohmic continuity implies that at least one relay contact is blocked (for welding) into closed position: this could only be verified after disassembling and individually testing each relay. Instead, to verify if a contact is blocked (for welding) into open position, use internal DIP-switches (n°1, 3, 5) to put in short circuit one relay coil at a time (starting with the 1st coil by DIP-switch n°1, then going on with the 2nd one by DIP-switch n°3, and finally proceeding with the 3rd one by DIP-switch n°5), verifying that the ohmic continuity is always present between terminals "13"-15". In this situation, the absence of ohmic continuity implies that a relay contact (the only one with de-energized coil) is blocked (for welding) into open position.
3	Remove the bypass from the safety-related PLC or restore normal operation inserting the unit.

This test reveals almost 99 % of all possible Dangerous Undetected failures in the relay module.

Warning

D5291 series is an electrical apparatus installed into standard EN/IEC60715 TH 35 DIN-Rail located in Safe Area or Zone 2, Group IIC, Temperature Classification T4, Hazardous Area within the specified operating temperature limits Tamb - 40 to +60 °C.

D5291 series must be installed, operated and maintained only by qualified personnel, in accordance to the relevant national/international installation standards (e.g. IEC/EN60079-14 Electrical apparatus for explosive gas atmospheres - Part 14: Electrical installations in hazardous areas (other than mines)), following the established installation rules.

De-energize power source (turn off power supply voltage) before plug or unplug the terminal blocks when installed in Hazardous Area or unless area is known to be nonhazardous.

Warning: substitution of components may impair Intrinsic Safety and suitability for Zone 2.

Warning: de-energize main power source (turn off power supply voltage) and disconnect plug-in terminal blocks before opening the enclosure to avoid electrical shock when connected to live hazardous potential.

Explosion Hazard: to prevent ignition of flammable or combustible atmospheres, disconnect power before servicing or unless area is known to be nonhazardous.

Failure to properly installation or use of the equipment may risk to damage the unit or severe personal injury.

The unit cannot be repaired by the end user and must be returned to the manufacturer or his authorized representative. Any unauthorized modification must be avoided.

Operation

D5291S relay module is suitable for the switching of safety related circuits, providing isolation between the input and output contacts.

D5291S provides 1 SPDT contact for two different safety functions:

- SIL 3 Safety Function for Normally De-Energized load (energized in fail safe state) is available at Terminal Blocks 13-14. The driving signal is normally low (0 Vdc), the relay is normally de-energized, contact is open and load is de-energized. The safety function is met when the driving signal is high (24 Vdc), the relay is energized, contact is closed and load is energized. At Terminal Blocks 13-15 is also available a service contact (for service load) with opposite (not SIL) function.
- SIL 3 Safety Function for Normally De-Energized load (energized in fail safe state) is available at Terminal Blocks 13-15. The driving signal is normally high (24 Vdc), the relay is normally energized, contact is open and load is de-energized. The safety function is met when the driving signal is low (0 Vdc), the relay is de-energized, contact is closed and load is energized. At Terminal Blocks 13-14 is also available a service contact (for service load) with opposite (not SIL) function.

A "RELAY STATUS" yellow led lights when input is powered, showing that relay is energized.

Installation

D5291 series is a relay output module housed in a plastic enclosure suitable for installation on T35 DIN-Rail according to EN50022 or on customized Termination Board.

D5291 series can be mounted with any orientation over the entire ambient temperature range.

Electrical connection are accommodated by polarized plug-in removable screw terminal blocks which can be plugged in/out into a powered unit without suffering or causing any damage **(for Zone 2 installations check the area to be nonhazardous before servicing)**. Connect only one individual conductor per each clamping point, use conductors up to 2.5 mm² (13 AWG) and a torque value of 0.5-0.6 Nm. The wiring cables have to be proportionate in base to the current and the length of the cable.

The wiring cables have to be proportionate in base to the current and the length of the cable.

On the section "Function Diagram" and enclosure side a block diagram identifies all connections.

Identify the function and location of each connection terminal using the wiring diagram on the corresponding section, as an example (application for a single D5291S):

Connect positive input at terminal "1" and negative input at "2" (positive input at terminal "3" and negative input at "4" are provided for daisy chain connection to the next module).

Connect positive or AC load supply line to SPDT Output Common pole (terminal "13").

Connect SIL 3 Normally De-Energized load between negative or AC load supply line and the terminal "14" (when relays are normally de-energized) or the terminal "15" (when relays are normally energized), as previously shown in the Functional Safety applications.

Installation and wiring must be in accordance to the relevant national or international installation standards (e.g. IEC/EN60079-14 Electrical apparatus for explosive gas atmospheres Part 14: Electrical installations in hazardous areas (other than mines)), make sure that conductors are well isolated from each other and do not produce any unintentional connection.

Connect SPST relay contacts checking the load rating to be within the contact maximum rating (10 A 250 Vac 2500 VA, 10 A 250 Vdc 300 W resistive load).

To prevent relay contacts from damaging, connect an external protection (fuse or similar), chosen according to the relay breaking capacity diagram on data sheet.

The enclosure provides, according to EN60529, an IP20 minimum degree of protection (or similar to NEMA Standard 250 type 1). The equipment shall only be used in an area of at least pollution degree 2, as defined in IEC 60664-1. When installed in EU Zone 2, the unit shall be installed in an enclosure that provides a minimum ingress protection of IP54 in accordance with IEC 60079-0. The enclosure must have a door or cover accessible only by the use of a tool. The end user is responsible to ensure that the operating temperature of the module is not exceeded in the end use application. Units must be protected against dirt, dust, extreme mechanical (e.g. vibration, impact and shock) and thermal stress, and casual contacts. If enclosure needs to be cleaned use only a cloth lightly moistened by a mixture of detergent in water.

Electrostatic Hazard: to avoid electrostatic hazard, the enclosure of D5291 series must be cleaned only with a damp or antistatic cloth.

Any penetration of cleaning liquid must be avoided to prevent damage to the unit. Any unauthorized card modification must be avoided.

All circuits connected to D5291 series must comply with the overvoltage category II (or better) according to EN/IEC60664-1.

Warning: de-energize main power source (turn off power supply voltage) and disconnect plug-in terminal blocks before opening the enclosure to avoid electrical shock when connected to live hazardous potential.

Start-up

Before powering the inputs of unit check that all wires are properly connected, also verifying their polarity. Check conductors for exposed wires that could touch each other causing dangerous unwanted shorts. Enabling input, the corresponding "RELAY STATUS" yellow led must be lit and load circuit must be according to the connection required. Indeed, disabling each input, the corresponding "RELAY STATUS" yellow led must be turned off and load circuit must change the status.

Configuration

An eight position DIP Switch is located on component side of pcb in order to set four mutually exclusive configurations:

- 1) line input monitoring, to allow DCS/PLC line input monitoring function (driving line pulse testing);
- 2) low voltage input monitoring (UVLO—under voltage lock out): module reflects a high impedance state to the control unit when the driving voltage is below the specified threshold;
- 3) T-proof relay testing.

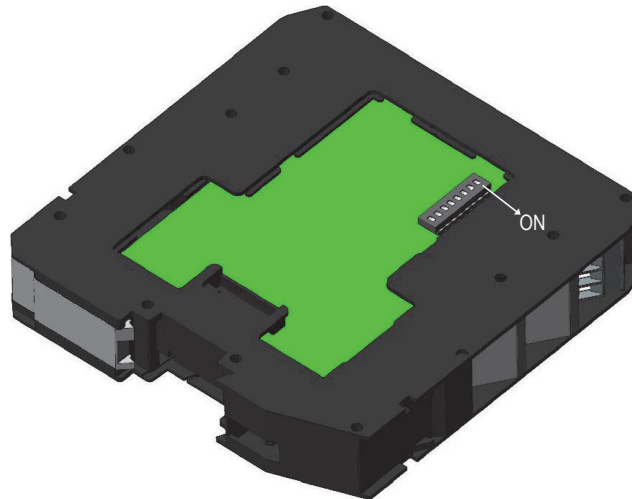

WARNING: dip-switch 2-4-6 must be set to "OFF" position for any configuration.

DIP switch configurations:

1) line input monitoring:

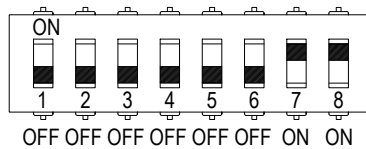

This is factory settings

2) low voltage input monitoring:

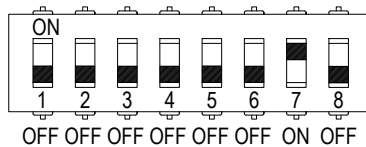

3) T-proof relay testing:

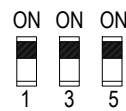
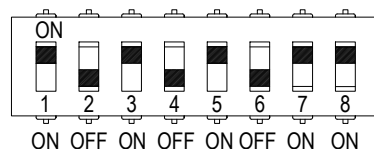

T-proof relays enable

T-proof relays (dip1 = relay1;
dip3 = relay2; dip5 = relay3)



Normal Operation

Please, see next page for testing procedure at T-proof.

WARNING: after T-proof test, dip-switch 1-3-5 must be set to "OFF" position for normal operation.