

INSTRUCTION & SAFETY MANUAL

SIL3 24/220Vdc/Vac Transistor-Out Detector
Models D5093S-TB, D5093D-TB



General Description:

The single and dual channel 24 to 220 Vac/Vdc Loop powered Switch Repeater D5093S-TB and D5093D-TB modules are units suitable for applications requiring SIL 3 level (according to IEC 61508:2010 Ed.2) in safety related systems for high risk industries. Each channel is able to reflect the presence of a 24 to 220 Vac/Vdc input signal to the output by closing an optically coupled NO open-drain transistor (solid-state relay, MOSFET output). The presence of the 24 to 220 Vac/Vdc input signal is also indicated by a yellow LED on the front panel. The input switching voltage levels are selected, according to the applied input signal, by means of an internal dip-switch. Mounting on customized Termination Boards, in Safe Area / Non Hazardous Location or in Zone 2 / Class I, Division 2.

Functional Safety Management Certification:

G.M. International is certified by TÜV to conform to IEC61508:2010 part 1 clauses 5-6 for safety related systems up to and included SIL3.



Technical Data

Loop Input:

loop powered control signal.

Loop Supply: 24 to 220 Vac/Vdc nominal (15 to 250 Vac/Vdc), 50 mA fuse internally protected.

Current consumption: 4.5 mA/channel @ 250 Vac/Vdc nominal input.

Power consumption: 1.13 W per channel with 250 Vac/Vdc input signal.

Isolation (Test Voltage):

In/Out 2.5 KV; In/In 2.5 KV; Out /Out 500 V.

Input switching voltage levels:

ON \geq 21 Vac/Vdc, OFF \leq 15 Vac/Vdc for 24 Vac/Vdc typical input

ON \geq 40 Vac/Vdc, OFF \leq 30 Vac/Vdc for 48 Vac/Vdc typical input

ON \geq 50 Vac/Vdc, OFF \leq 35 Vac/Vdc for 60 Vac/Vdc typical input

ON \geq 100 Vac/Vdc, OFF \leq 75 Vac/Vdc for 120 Vac/Vdc typical input

ON \geq 200 Vac/Vdc, OFF \leq 160 Vac/Vdc for 220 Vac/Vdc typical input

threshold level selection by means of internal dip-switch.

Output:

voltage free SPST optocoupled open-drain transistor (solid-state relay, MOSFET output).

Open-collector rating: 50 mA at 35 Vdc (\leq 0.5 Vdc voltage drop).

Leakage current: \leq 10 μ A at 35 Vdc.

Response time: \leq 120 ms.

Frequency response: 10 Hz maximum.

Compatibility:



CE mark compliant, conforms to Directive: 2014/34/EU ATEX, 2014/30/EU EMC, 2014/35/EU LVD, 2011/65/EU RoHS.

Environmental conditions:

Operating: temperature limits - 40 to + 70 °C, relative humidity 95 %, up to 55 °C.

Storage: temperature limits - 45 to + 80 °C.

Max altitude: 2000 m a.s.l.

Safety Description:



ATEX: II 3G Ex ec IIC T4 Gc

IECEx / INMETRO: Ex ec IIC T4 Gc

EAC-EX: 2Ex nA IIC T4 Gc X

CCC: Ex ec IIC T4 Gc

UKR TR n. 898: 2ExnAIICT4 X

Approvals:

BVS 10 ATEX E 114 X conforms to EN60079-0, EN60079-7.

IECEx BVS 10.0072X conforms to IEC60079-0, IEC60079-7.

INMETRO DNV 13.0109 X conforms to ABNT NBR IEC60079-0, ABNT NBR IEC60079-7, ABNT NBR IEC60079-15.

UL & C-UL E222308 conforms to UL 61010-1, UL 121201 for UL and CAN/CSA C22.2 No. 61010-1-12, CSA C22.2 No. 213-17 for C-UL.

EAЭC RU C-IT.AA87.B.00765/21 conforms to GOST 31610.0, GOST 31610.15.

CCC n. 2020322316000978 conforms to GB/T 3836.1, GB/T 3836.3

ЦЛ 16.0036 X conforms to ДСТУ 7113, ДСТУ IEC 60079-15.

TÜV Certificate No. C-IS-224248-01 SIL 3 conforms to IEC61508:2010 Ed. 2.

SIL 3 Functional Safety TÜV Certificate conforms to IEC61508:2010 Ed.2, for Management of Functional Safety.

Mounting:

On customized Termination Board.

Weight: about 115 g D5093D-TB, 105 g D5093S-TB.

Connection: by polarized plug-in disconnect screw terminal blocks to accommodate terminations up to 2.5 mm².

Location: installation in Safe Area/Non Hazardous Locations or Zone 2, Group IIC T4 or Class I, Division 2, Group A,B,C,D, T4.

Protection class: IP 20.

Dimensions: Width 12.5 mm, Depth 123 mm, Height 120 mm.

Ordering Information

Model: D5093	-TB
1 channel	S
2 channels	D

Front Panel and Features

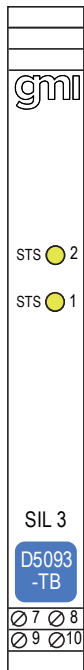

- SIL 3 according to IEC 61508:2010 Ed.2 for Tproof = 6 / 20 years ($\leq 10\%$ / $>10\%$ of total SIF)
- PFDavg (1 year) 1.54 E-05, SFF 96.53 %.
- Systematic capability SIL 3.
- 2 fully independent channels (only for D5093D-TB).
- Installation in Zone 2 / Safe Area.
- Input/Output and Channel/Channel isolation.
- EMC Compatibility to EN61000-6-2, EN61000-6-4, EN61326-1, EN61326-3-1 for safety system.
- ATEX, IECEx, UL & C-UL, INMETRO, EAC Ex, UKR TR n. 898, TÜV Certifications.
- TÜV Functional Safety Certification
- High Density, two channels per unit (D5093D-TB).
- Simplified installation on customized Termination Boards.

Terminal block connections

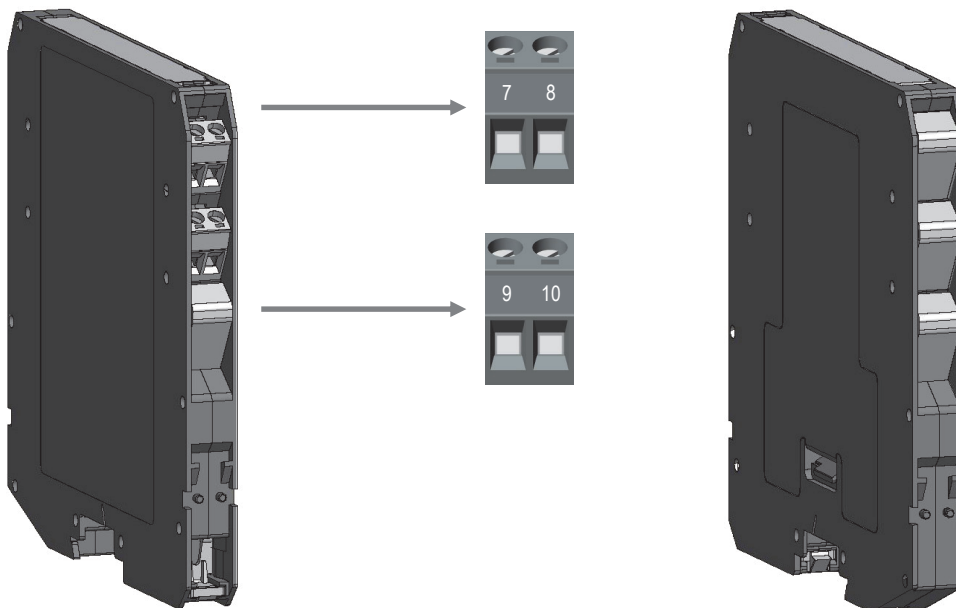

7	24 to 220 Vac/Vdc Input Ch1
8	
9	24 to 220 Vac/Vdc Input Ch2 (only for D5093D-TB)
10	

Function Diagram

SAFE AREA, ZONE 2 GROUP IIC T4,
NON HAZARDOUS LOCATIONS, CLASS I, DIVISION 2,
GROUPS A, B, C, D T-Code T4

MODEL D5093D-TB

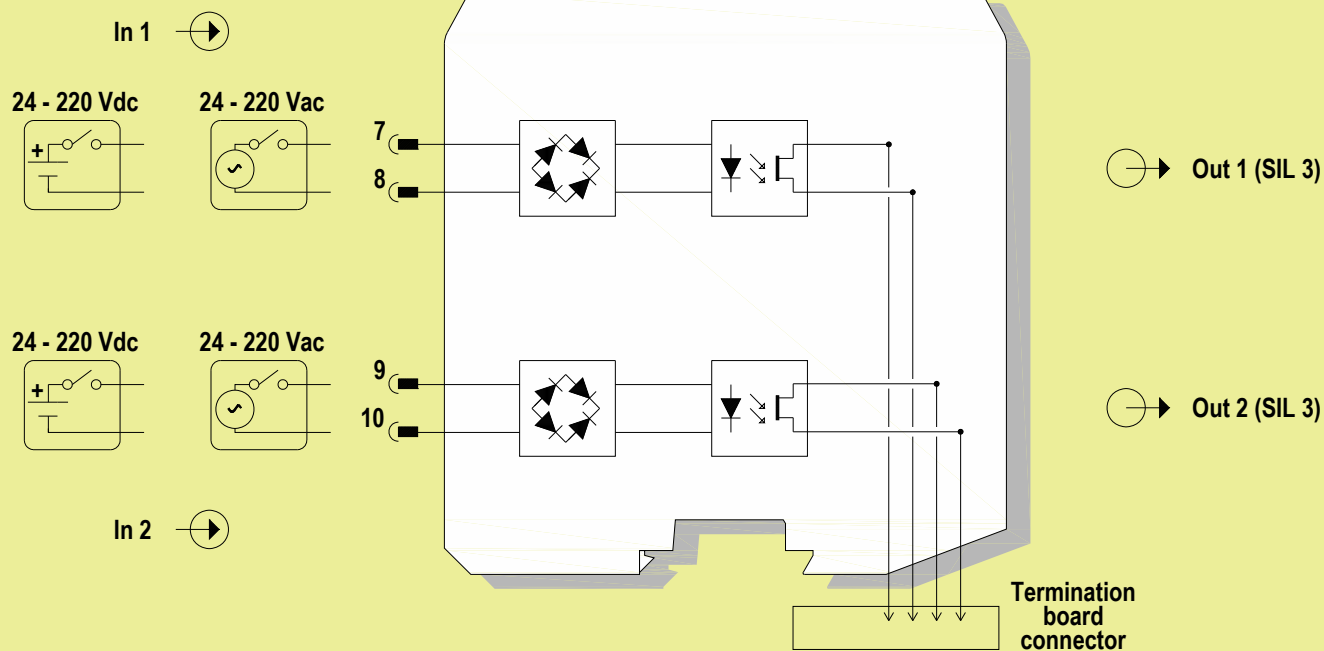

MODEL D5093S-TB

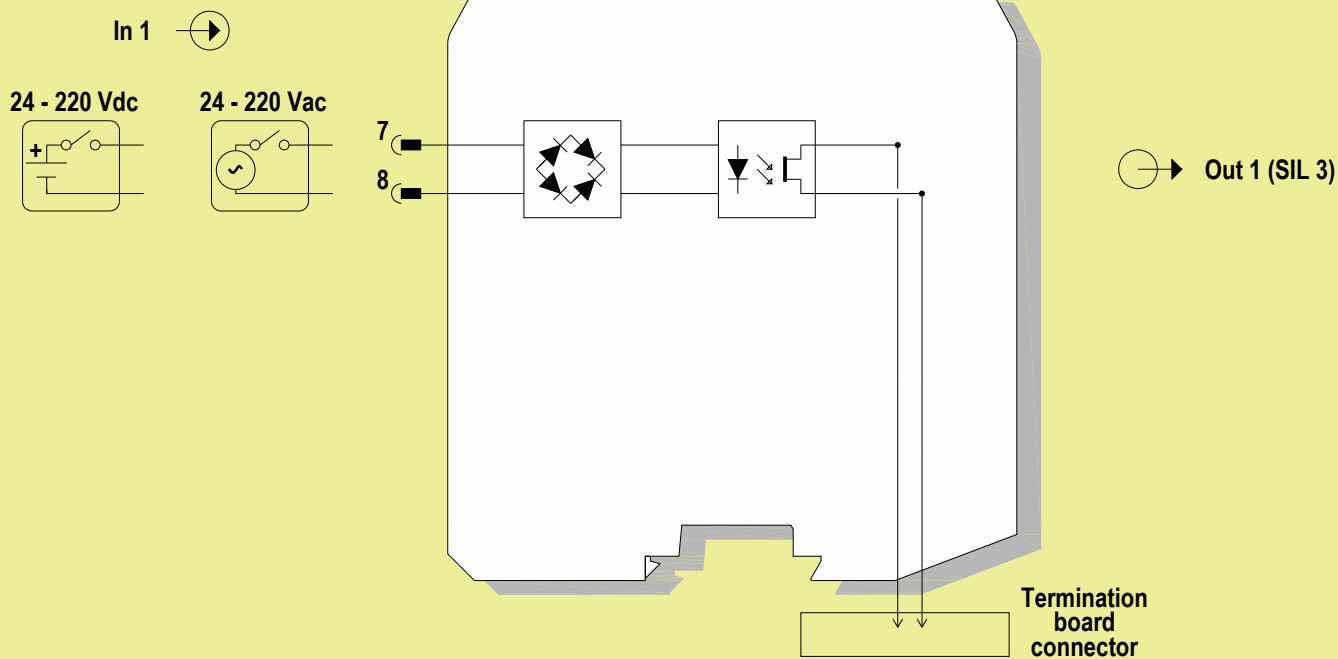

Application for D5093S-TB or D5093D-TB

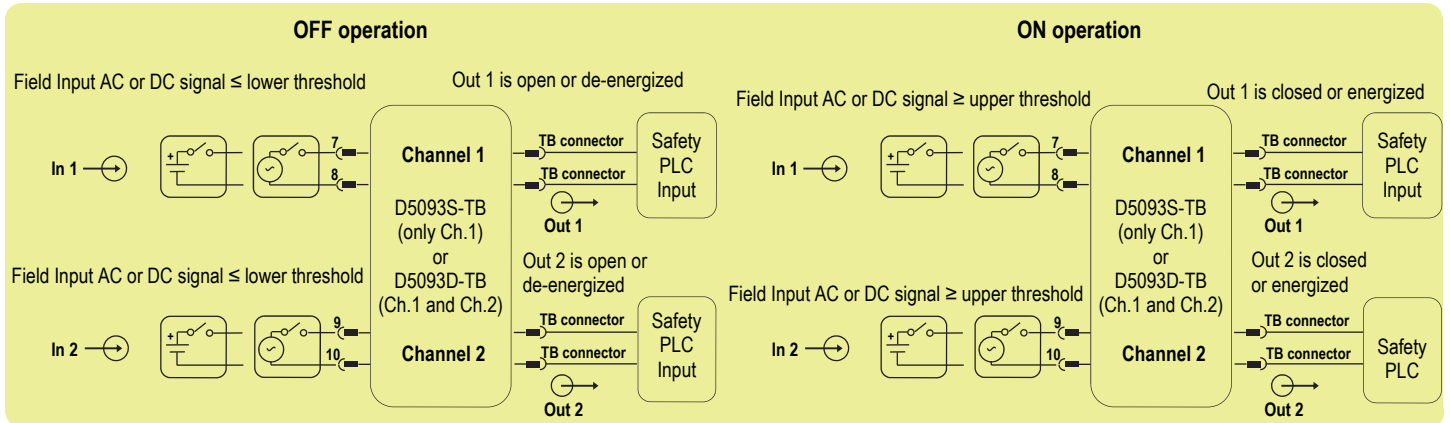

Description:

Input AC or DC signals from field are applied to Pins 7-8 (In 1 - Ch.1) and Pins 9-10 (In 2 - Ch.2, only for D5093D-TB). See table below for the lower and upper threshold levels. Open-drain transistor outputs on TB connector (for Channel 1 and, only for D5093D-TB, for Channel 2) are both normally open (or de-energized as safe state condition) for OFF operation, or they are both closed (or energized) for ON operation. See page 6 for DIP-switch configuration.

Typical input signal	Dip-switch position to be enabled (ON)	Lower threshold	Upper threshold
24 Vac / Vdc	1	15 Vac / Vdc	21 Vac / Vdc
48 Vac / Vdc	2	30 Vac / Vdc	40 Vac / Vdc
60 Vac / Vdc	3	35 Vac / Vdc	50 Vac / Vdc
110 Vac / Vdc	4	75 Vac / Vdc	100 Vac / Vdc
220 Vac / Vdc	5	160 Vac / Vdc	200 Vac / Vdc

The following table describes the state (open or closed) of each output when its input AC or DC signal is in the High (\geq upper threshold) or Low (\leq lower threshold) state.

Operation	Input Signal state Pins 7-8 (In 1 - Ch.1) or 9-10 (In 2 - Ch.2)	Output state TB connector (Out 1 - Ch.1 or Out 2 - Ch.2)
OFF	Low (\leq lower threshold)	Open (De-energized as safe state condition)
ON	High (\geq upper threshold)	Closed (Energized)

Safety Function and Failure behavior:

D5093-TB is considered to be operating in Low Demand mode, as a Type A module, having Hardware Fault Tolerance (HFT) = 0.

The failure behaviour is described from the following definitions :

- fail-Safe State: it is defined as the transistor output being de-energized or open;
- fail Safe: failure mode that causes the module to go to the defined fail-safe state without a demand from the process;
- fail Dangerous: failure mode that does not respond to a demand from the process (i.e. being unable to go to the defined fail-safe state), so that the transistor output remains energized or closed;
- fail "No Effect": failure mode of a component that plays a part in implementing the safety function but that is neither a safe failure nor a dangerous failure. When calculating the SFF this failure mode is not taken into account;
- fail "Not part": failure mode of a component which is not part of the safety function but part of the circuit diagram and is listed for completeness. When calculating the SFF this failure mode is not taken into account.

The 2 channels of D5093D-TB module could be used to increase the hardware fault tolerance, needed for a higher SIL of a certain Safety Function, as they are completely independent from each other, not containing common components. In fact, the analysis results got for D5093S-TB (single ch.) are also valid for each channel of D5093D-TB (double ch.).

Failure rate data: taken from Siemens Standard SN29500.

Failure rate table:

Failure category	Failure rates (FIT)
λ_{dd} = Total Dangerous Detected failures	0.00
λ_{du} = Total Dangerous Undetected failures	3.52
λ_{sd} = Total Safe Detected failures	0.00
λ_{su} = Total Safe Undetected failures	98.05
$\lambda_{tot\ safe}$ = Total Failure Rate (Safety Function) = $\lambda_{dd} + \lambda_{du} + \lambda_{sd} + \lambda_{su}$	101.57
MTBF (safety function, single channel) = $(1 / \lambda_{tot\ safe}) + MTTR$ (8 hours)	1123 years
$\lambda_{no\ effect}$ = "No Effect" failures	98.33
$\lambda_{not\ part}$ = "Not Part" failures	2.90
$\lambda_{tot\ device}$ = Total Failure Rate (Device) = $\lambda_{tot\ safe} + \lambda_{no\ effect} + \lambda_{not\ part}$	202.80
MTBF (device, single channel) = $(1 / \lambda_{tot\ device}) + MTTR$ (8 hours)	562 years

NOTE: These values are always valid for each of 5 possible thresholds.

Failure rates table according to IEC 61508:2010 Ed.2 :

λ_{sd}	λ_{su}	λ_{dd}	λ_{du}	SFF
0.00 FIT	98.05 FIT	0.00 FIT	3.52 FIT	96.53%

PFDavg vs T[Proof] table (assuming Proof Test coverage of 95%), with determination of SIL supposing module contributes $\leq 10\%$ of total SIF dangerous failures:

T[Proof] = 1 year	T[Proof] = 6 years
PFDavg = 1.54 E-05 - Valid for SIL 3	PFDavg = 9.27 E-05 - Valid for SIL 3

PFDavg vs T[Proof] table (assuming Proof Test coverage of 95%), with determination of SIL supposing module contributes $> 10\%$ of total SIF dangerous failures:

T[Proof] = 20 years
PFDavg = 3.09 E-04 - Valid for SIL 3

Systematic capability SIL 3.

Testing procedure at T-proof

The proof test shall be performed to reveal dangerous faults which are undetected by diagnostic. This means that it is necessary to specify how dangerous undetected faults, which have been noted during the FMEDA, can be revealed during proof test. The Proof test consists of the following steps:

Steps	Action
1	Bypass on input the module channels under test, taking appropriate action in order to avoid a false trip, and use the safety-related PLC to read channel output state during the test.
2	<p>Connect a variable DC / AC source to any input terminals couple (7-8 for D5093S-TB and 7-8, 9-10 for D5093D-TB).</p> <p>For each channel, during normal operation, when the input DC / AC voltage amplitude is comprised between 15 Vdc / Vrms and 250 Vdc / Vrms (maximum allowed value for the module safe operation) and the appropriate threshold is selected, by means of the internal dip-switch, in accordance with the applied input signal, the output transistor is in the closed state, as detectable by the safety-related PLC, and the yellow channel status LED is lit. A safe failure is present if the output transistor is in the open state instead of the closed state.</p> <p>Then, when the input DC / AC voltage amplitude falls below the related lower threshold value, the output transistor turns to the open state, as detectable by the safety-related PLC, and the yellow status LED is turned off. A dangerous failure is present if the output transistor is in the closed state instead of the open state and two possible dangerous fault situations could be happened:</p> <ol style="list-style-type: none"> 1) if the channel status LED has been turned off, then the output transistor is in short circuit; 2) if the status LED is lit again, then the comparator stage threshold has been excessively lowered and the output transistor is again energized. <p>Repeat this test for all of the five possible threshold voltage levels (each one of them corresponds to a different position of the dip-switch selector).</p>
3	Restore the loop to full and normal operation, removing the bypass on input the module channels under test.

This test reveals almost 95 % of all possible Dangerous Undetected failures in the module.

Configuration

D5093-TB

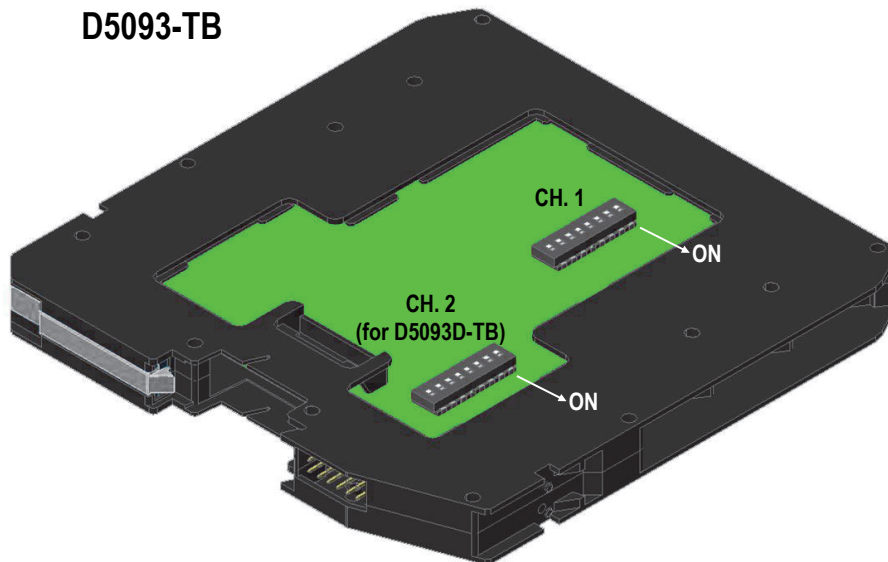

DIP switch configurations (all valid for SIL applications):

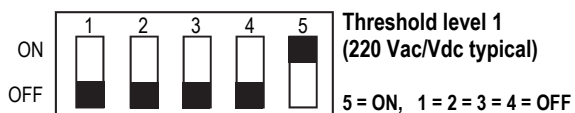
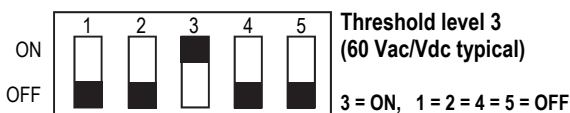
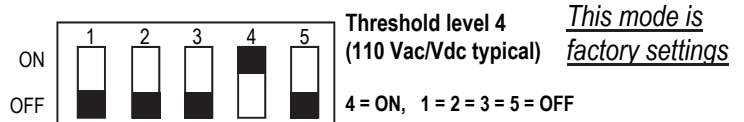
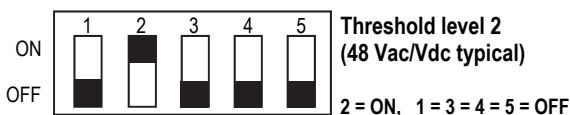
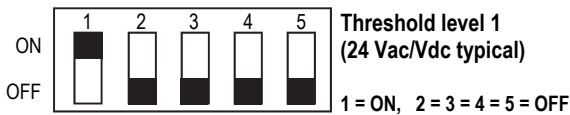

DIP switch positions 6 to 8 are not used.

Warning

D5093-TB series is electrical apparatus installed on customized Termination Board located in Safe Area or Zone 2, Group IIC, Temperature Classification T4 or Class I, Division 2, Group A, B, C, D, T4 Hazardous Area within the specified operating temperature limits Tamb - 40 to +70 °C.

D5093-TB series must be installed, operated and maintained only by qualified personnel, in accordance to the relevant national/international installation standards (e.g. IEC/EN60079-14 Electrical apparatus for explosive gas atmospheres - Part 14: Electrical installations in hazardous areas (other than mines)), following the established installation rules.

De-energize power source (turn off power supply voltage) before plug or unplug the terminal blocks when installed in Hazardous Area or unless area is known to be nonhazardous.

Warning: substitution of components may impair suitability for Zone 2/Division 2. Avertissement: la substitution des composants peut nuire à l'aptitude à la Zone 2/Div. 2.

Explosion Hazard: to prevent ignition of flammable atmospheres, disconnect power before servicing or unless area is known to be nonhazardous. Danger d'Explosion: pour éviter l'inflammation d'atmosphères inflammables, débrancher l'alimentation avant l'entretien ou à moins que région est connue pour être non dangereuse.

Warning: de-energize main power source (turn off power supply voltage) and disconnect plug-in terminal blocks before opening the enclosure to avoid electrical shock when connected to live hazardous potential. Avertissement: débrancher l'alimentation (couper la tension d'alimentation) et les blocs de jonction enfichables avant d'ouvrir le boîtier pour éviter les chocs électriques lorsqu'ils sont connectés à un potentiel dangereux.

Failure to properly installation or use of the equipment may risk to damage the unit or severe personal injury.

The unit cannot be repaired by the end user and must be returned to the manufacturer or his authorized representative. Any unauthorized modification must be avoided.

Operation

The single and dual channel 24 to 220 Vac / Vdc Loop powered Switch Repeater, D5093S-TB and D5093D-TB module is a unit suitable for applications requiring SIL 3 level (according to IEC 61508:2010 Ed. 2) in safety related systems for high risk industries.

Each channel is able to reflect the presence of a 24 to 220 Vac / Vdc input signal to the output by closing an optocoupled NO open-drain transistor.

The presence of the input signal is also indicated by a "STATUS CHANNEL" Yellow LED on the front panel.

Installation

D5093-TB series are 24 to 220 Vac / Vdc Loop powered Switch Repeater modules housed in a plastic enclosure suitable for installation on customized Termination Board.

D5093-TB series can be mounted with any orientation over the entire ambient temperature range.

Electrical connection are accommodated by polarized plug-in removable screw terminal blocks which can be plugged in/out into a powered unit without suffering or causing any damage **(for Zone 2 installations check the area to be nonhazardous before servicing)**. Connect only one individual conductor per each clamping point, use conductors up to 2.5 mm² (13 AWG) and a torque value of 0.5-0.6 Nm. For USA and Canada installations, use only cables that are suitable for a temperature of at least 85°C. The wiring cables have to be proportionate in base to the current and the length of the cable.

In case of installation in zone 2, the connecting cables of non-intrinsically safe circuits must be safely routed in a cable duct or similar. The distance between the pluggable connection terminal and the cable duct should not exceed 500 mm cable length.

On the section "Function Diagram" and enclosure side a block diagram identifies all connections.

Installation and wiring must be in accordance to the relevant national or international installation standards (e.g. IEC/EN60079-14 Electrical apparatus for explosive gas atmospheres Part 14: Electrical installations in hazardous areas (other than mines)), make sure that conductors are well isolated from each other and do not produce any unintentional connection.

Connect output transistors checking the load rating to be within the maximum rating (50 mA at 35 Vdc (± 0.5 Vdc voltage drop)).

The enclosure provides, according to EN60529, an IP20 minimum degree of protection (or similar to NEMA Standard 250 type 1). The equipment shall only be used in an area of at least pollution degree 2, as defined in IEC 60664-1. When installed in EU Zone 2, the unit shall be installed in an enclosure that provides a minimum ingress protection of IP54 in accordance with IEC 60079-0. When installed in a Class I, Division 2 Hazardous Location, the unit shall be mounted in a supplemental enclosure that provides a degree of protection not less than IP54. The enclosure must have a door or cover accessible only by the use of a tool. The end user is responsible to ensure that the operating temperature of the module is not exceeded in the end use application.

Units must be protected against dirt, dust, extreme mechanical (e.g. vibration, impact and shock) and thermal stress, and casual contacts. If enclosure needs to be cleaned use only a cloth lightly moistened by a mixture of detergent in water.

Electrostatic Hazard: to avoid electrostatic hazard, the enclosure of D5093-TB series must be cleaned only with a damp or antistatic cloth.

Any penetration of cleaning liquid must be avoided to prevent damage to the unit. Any unauthorized card modification must be avoided.

All circuits connected to D5093-TB series must comply with the overvoltage category II (or better) according to EN/IEC60664-1.

Warning: de-energize main power source (turn off power supply voltage) and disconnect plug-in terminal blocks before opening the enclosure to avoid electrical shock when connected to live hazardous potential.

Start-up

Before powering the inputs of unit check that all wires are properly connected, also verifying their polarity. Check conductors for exposed wires that could touch each other causing dangerous unwanted shorts. When loop powered signal is applied to input channel with a value more than 21 Vac / Vdc for threshold 1, 40 Vac / Vdc for threshold 2, 50 Vac / Vdc for threshold 3, 100 Vac / Vdc for threshold 4, 200 Vac / Vdc for threshold 5, the corresponding transistor output must be closed and the "STATUS CHANNEL" yellow LED must be lit. Instead, when loop powered signal is less than 15 Vac / Vdc for threshold 1, 30 Vac / Vdc for threshold 2, 35 Vac / Vdc for threshold 3, 75 Vac / Vdc for threshold 4, 160 Vac / Vdc for threshold 5, the corresponding transistor output must be open and the "STATUS CHANNEL" yellow LED must be turned off.