



INSTRUCTION & SAFETY MANUAL

SIL 3 Digital Output Driver, NE Loads,
Bus Powered DIN Rail and
Termination Board, Model D5049S



Characteristics

General Description: The single channel Bus Powered Digital Output Isolator, D5049S, is suitable for driving solenoid valves, visual or audible alarms to alert a plant operator, or other process control devices in Hazardous Area from a driving signal in Safe Area. It can also be used as a controllable supply to power measuring or process control equipment. Its use is allowed in applications requiring up to SIL 3 level (according to IEC 61508:2010 Ed. 2) in safety related systems for high risk industries. The Safety PLC or DCS driving signal controls the field device through the D5049S, which provides isolation and is capable of monitoring the conditions of the line. Short and open circuit diagnostic monitoring, dip-switch selectable, operates irrespective of the channel condition and provides LED indication and NC transistor output signaling. When fault is detected output is de-energized until normal condition is restored. An override input, dip-switch selectable, is provided to permit a safety system to override the control signal. When enabled, a low input voltage always de-energizes the field device regardless of the input signal. Three basic output circuits are selectable, with different safety parameters, to interface the majority of devices on the market. The selection among the three output characteristics is obtained by connecting the field device to a different terminal block. Mounting on standard DIN-Rail, with or without Power Bus, or on customized Termination Boards, in Safe Area / Non Hazardous Location or in Zone 2 / Class I, Division 2 or Class I, Zone 2.

Functional Safety Management certification: G.M. International is certified by TUV to conform to IEC61508:2010 part 1 clauses 5-6 for safety related systems up to and included SIL3.



Technical Data

Supply: 24 Vdc nom (20 to 30 Vdc) reverse polarity protected, ripple within voltage limits ≤ 5 Vpp, 2 A time lag fuse internally protected.
Current consumption @ 24 V: 65 mA with 45 mA output typical in normal operation.
Power dissipation: 1.1 W with 24 V supply, output energized at 45 mA nominal load.
Isolation (Test Voltage): I.S. Out/In 2.5 KV; I.S. Out/Supply 2.5 KV; I.S. Out/Fault-Override 2.5 KV; In/Supply 500 V; In/Fault-Override 500 V; Supply/Fault-Override 500 V.
Control input: switch contact, logic level reverse polarity protected.
Trip voltage levels: OFF status ≤ 5.0 V, ON status ≥ 20.0 V (maximum 30 V).
Current consumption @ 24 V: 15 mA max.
Override Input: override control signal de-energizes output when enabled by dip-switch.
Override range: 24 Vdc nom (20 to 30 Vdc) to disable (field device controlled by input), 0 to 5 Vdc to de-energize field device, reverse polarity protected.
Current consumption @ 24 V: 15 mA max.
Output: 45 mA at 13.0 V (21.0 V no load, 174 Ω series resistance) at terminals 7-10 Out A.
 45 mA at 10.2 V (21.0 V no load, 236 Ω series resistance) at terminals 8-10 Out B.
 45 mA at 8.5 V (21.0 V no load, 275 Ω series resistance) at terminals 9-10 Out C.
Short circuit current: ≥ 50 mA (55 mA typical).

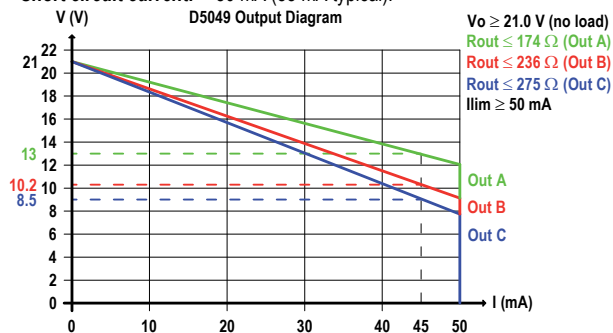

Response time: ≤ 30 ms (for direct input-output transfer); ≤ 75 ms (for inverted input-output transfer)
Frequency response: 50 Hz
Fault detection: field device and wiring open circuit or short circuit detection dip-switch selectable. When fault is detected output is de-energized until normal condition is restored.
Short output detection: load resistance $\leq 50 \Omega$ (≈ 2 mA forcing to detect fault).
Open output detection: load resistance > 10 K Ω .
Fault signalling: voltage free NE SPST optocoupled open-collector transistor (output de-energized in fault condition).
Open-collector rating: 100 mA at 35 Vdc (≤ 1.5 V voltage drop).
Leakage current: $\leq 50 \mu$ A at 35 Vdc.
Response time: ≤ 75 ms.

Compatibility:

CE CE mark compliant, conforms to Directive: 2014/34/EU ATEX, 2014/30/EU EMC, 2014/35/EU LVD, 2011/65/EU RoHS.

Environmental conditions:

Operating: temperature limits -40 to $+70$ $^{\circ}$ C, relative humidity 95 %, up to 55 $^{\circ}$ C. **Storage:** temperature limits -45 to $+80$ $^{\circ}$ C.
Max altitude: 2000 m a.s.l.

Safety Description:



ATEX: II 3(1)G Ex ec [ja Ga] IIC T4 Gc, II (1)D [Ex ia Da] IIC, I (M1) [Ex ia Ma] I. **IECEx / INMETRO:** Ex ec [ja Ga] IIC T4 Gc, [Ex ia Da] IIC, [Ex ia Ma] I
UL: NI / I / 2 / ABCD / T4, AIS / I, II, III / 1 / ABCDEFG, AEx nA [ja Ga] IIC T4 Gc. **C-UL:** NI / I / 2 / ABCD / T4, AIS / I, II, III / 1 / ABCDEFG, Ex nA [ja Ga] IIC T4 Gc
FM: NI-AIS / I / 2 / ABCD / T4, AIS / I, II, III / 1 / ABCDEFG, I / 2 / AEx nA [ja] / IIC / T4. **FMC:** NI-AIS / I / 2 / ABCD / T4, AIS / I, II, III / 1 / ABCDEFG, I / 2 / Ex nA [ja] / IIC / T4
EAC-EX: 2Ex ec [ja Ga] IIC T4 Gc X; [Ex ia Da] IIC X; [Ex ia Ma] I X. **CCC:** Ex ec [ja Ga] IIC T4 Gc; [Ex ia Ga] IIC; [Ex ia Da] IIC.

associated apparatus and non-sparking electrical equipment.
 Uo/Voc = 24.8 V, Io/Isc = 147 mA, Po/Po = 907 mW at terminals 7-10 Out A.
 Uo/Voc = 24.8 V, Io/Isc = 108 mA, Po/Po = 667 mW at terminals 8-10 Out B.
 Uo/Voc = 24.8 V, Io/Isc = 93 mA, Po/Po = 571 mW at terminals 9-10 Out C.
 Um = 250 Vrms, -40 $^{\circ}$ C \leq Ta ≤ 70 $^{\circ}$ C.

Approvals:

BVS 10 ATEX E 113 X conforms to EN60079-0, EN60079-7, EN60079-11.
 IECEx BVS 10.0072 X conforms to IEC60079-0, IEC60079-7, IEC60079-11.
 INMETRO DNV 13.0109 X conforms to ABNT NBR IEC60079-0, ABNT NBR IEC60079-7, ABNT NBR IEC60079-11.
 UL & C-UL E222308 conforms to UL913, UL 60079-0, UL60079-11, UL60079-15, ANSI/ISA 12.12.01 for UL and CSA-C22.2 No.157-92, CSA-E60079-0, CSA-E60079-11, CSA-C22.2 No. 213 and CSA-E60079-15 for C-UL.
 FM 3046304 and FMC 3046304C conforms to Class 3600, 3610, 3611, 3810,
 ANSI/ISA-60079-0, ANSI/ISA-60079-11, ANSI/ISA-60079-15, C22.2 No.142, C22.2 No.157, C22.2 No.213, C22.2 No. 60079-0, C22.2 No. 60079-11, C22.2 No. 60079-15.
 EA3C RU C-IT AA87.B.01310/24 conforms to GOST 31610.0, GOST 31610.7, GOST 31610.11.
 CCC n. 2020322316000978 conforms to GB/T 3836.1, GB/T 3836.3, GB/T 3834.4
 TC21109 for TIS approval.
 TÜV Certificate No. C-IS-236198-04, SIL 3 conforms to IEC61508:2010 Ed.2.
 SIL 3 Functional Safety TÜV Certificate conforms to IEC61508:2010 Ed.2, for Management of Functional Safety.
 DNV Type Approval Certificate No. TAA00001U0 and KR No.MIL20769-EL002 Certificates for maritime applications.

Mounting:

EN/IEC60715 TH 35 DIN-Rail with or without Power Bus or on customized Termination Board.
Weight: about 130 g.
Connection: by polarized plug-in disconnect screw terminal blocks to accommodate terminations up to 2.5 mm².
Location: installation in Safe Area/Non Hazardous Locations or Zone 2, Group IIC T4 or Class I, Division 2, Group A,B,C,D, T4 or Class I, Zone 2, Group IIC, T4.
Protection class: IP 20.
Dimensions: Width 12.5 mm, Depth 123 mm, Height 120 mm.

Ordering information

Model: D5049S

Power Bus and DIN-Rail accessories:
Connector JDFT049
Terminal block male MOR017

Cover and fix MCHP196
Terminal block female MOR022

Front Panel and Features

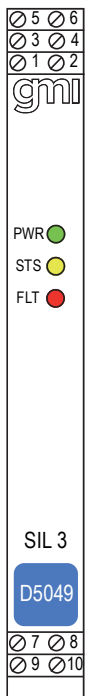

- SIL 3 according to IEC 61508:2010 Ed. 2 for Tproof = 12 / 20 yrs ($\leq 10\%$ / $> 10\%$ of total SIF).
- PFDavg (1 year) 8.32 E-06, SFF 98.91 %.
- SIL 3 Systematic capability
- Output to Zone 0 (Zone 20), installation in Zone 2.
- Bus powered for NE loads.
- Short and open circuit line diagnostic monitoring with LED, transistor output.
- Output short circuit proof and current limited.
- Three port isolation, Input/Output/Supply.
- EMC Compatibility to EN61000-6-2, EN61000-6-4, EN61326-1, EN61326-3-1 for safety system.
- In-field programmability by DIP Switch.
- ATEX, IECEx, UL & C-UL, FM, FMC, INMETRO, EAC-EX, CCC, TIIS, TÜV Certifications.
- TÜV Functional Safety Certification.
- Type Approval Certificate DNV and KR for maritime applications.
- Simplified installation using standard DIN-Rail and plug-in terminal blocks, with or without Power Bus, or customized Termination Boards.
- 250 Vrms (Um) max. voltage allowed to the instruments associated with the barrier.

Terminal block connections

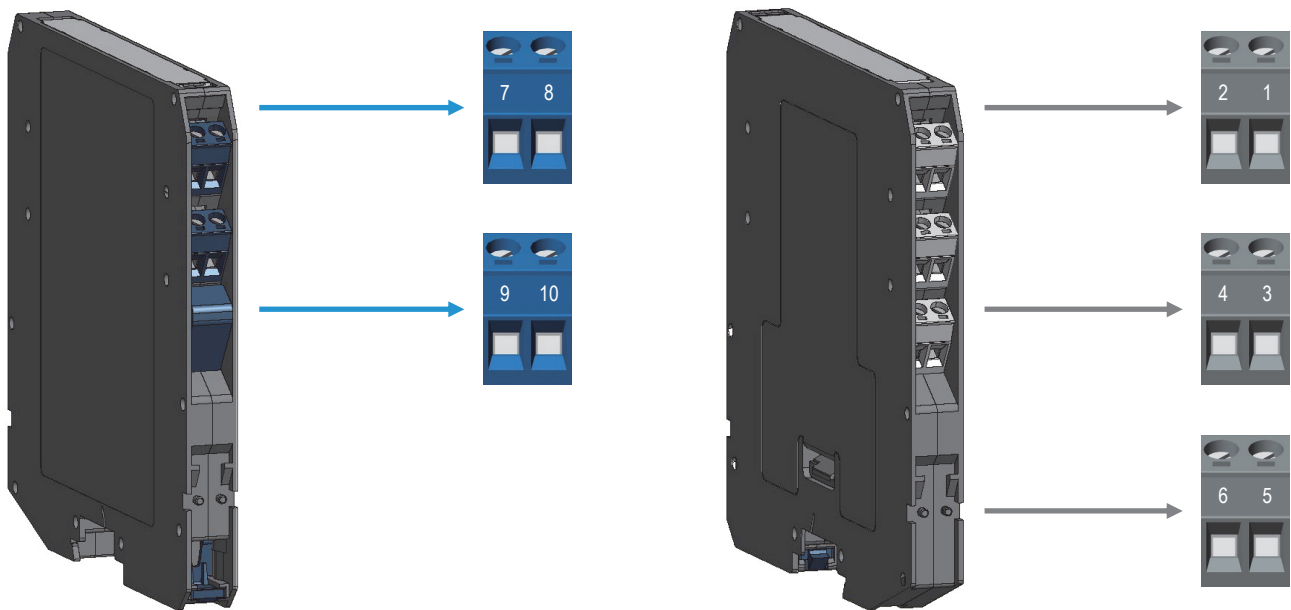

HAZARDOUS AREA

- | | |
|----|-------------------------------|
| 7 | + Output A for Solenoid Valve |
| 8 | + Output B for Solenoid Valve |
| 9 | + Output C for Solenoid Valve |
| 10 | - Output for Solenoid Valve |

SAFE AREA

- | | |
|---|---|
| 1 | + Control Input |
| 2 | - Control Input |
| 3 | + Transistor Fault Output or + Input Override |
| 4 | - Transistor Fault Output or - Input Override |
| 5 | + Power Supply 24 Vdc |
| 6 | - Power Supply 24 Vdc |

Parameters Table

In the system safety analysis, always check the Hazardous Area/Hazardous Locations devices to conform with the related system documentation, if the device is Intrinsically Safe check its suitability for the Hazardous Area/Hazardous Locations and group encountered and that its maximum allowable voltage, current, power (U_i/V_{max} , I_i/I_{max} , P_i/P_i) are not exceeded by the safety parameters (U_o/V_{oc} , I_o/I_{sc} , P_o/P_o) of the D5049 series Associated Apparatus connected to it. Also consider the maximum operating temperature of the field device, Check that added connecting cable and field device capacitance and inductance do not exceed the limits (C_o/C_a , L_o/L_a , L_o/R_o) given in the Associated Apparatus parameters for the effective group. See parameters indicated in the table below:

D5049 Terminals		D5049 Associated Apparatus Parameters		Must be	Hazardous Area/ Hazardous Locations Device Parameters
Out A	7 - 10	$U_o / V_{oc} = 24.8 \text{ V}$		\leq	U_i / V_{max}
Out B	8 - 10				
Out C	9 - 10				
Out A	7 - 10	$I_o / I_{sc} = 147 \text{ mA}$		\leq	I_i / I_{max}
Out B	8 - 10				
Out C	9 - 10				
Out A	7 - 10	$P_o / P_o = 907 \text{ mW}$		\leq	P_i / P_i
Out B	8 - 10				
Out C	9 - 10				
D5049 Terminals		D5049 Associated Apparatus Parameters Cenelec (US)		Must be	Hazardous Area/ Hazardous Locations Device + Cable Parameters
Out A	7 - 10	$C_o / C_a = 113 \text{ nF}$	IIC (A, B)	\geq	$C_i / C_i \text{ device} + C \text{ cable}$
		$C_o / C_a = 860 \text{ nF}$	IIB (C)		
		$C_o / C_a = 3.05 \mu\text{F}$	IIA (D)		
		$C_o / C_a = 4.35 \mu\text{F}$	I		
		$C_o / C_a = 860 \text{ nF}$	IIIC (E, F, G)		
Out B	8 - 10	$C_o / C_a = 113 \text{ nF}$	IIC (A, B)	\geq	$C_i / C_i \text{ device} + C \text{ cable}$
		$C_o / C_a = 860 \text{ nF}$	IIB (C)		
		$C_o / C_a = 3.05 \mu\text{F}$	IIA (D)		
		$C_o / C_a = 4.32 \mu\text{F}$	I		
		$C_o / C_a = 860 \text{ nF}$	IIIC (E, F, G)		
Out C	9 - 10	$C_o / C_a = 113 \text{ nF}$	IIC (A, B)	\geq	$C_i / C_i \text{ device} + C \text{ cable}$
		$C_o / C_a = 860 \text{ nF}$	IIB (C)		
		$C_o / C_a = 3.05 \mu\text{F}$	IIA (D)		
		$C_o / C_a = 4.35 \mu\text{F}$	I		
		$C_o / C_a = 860 \text{ nF}$	IIIC (E, F, G)		
Out A	7 - 10	$L_o / L_a = 0.04 \text{ mH}$	IIC (A, B)	\geq	$L_i / L_i \text{ device} + L \text{ cable}$
		$L_o / L_a = 6.63 \text{ mH}$	IIB (C)		
		$L_o / L_a = 13.27 \text{ mH}$	IIA (D)		
		$L_o / L_a = 21.78 \text{ mH}$	I		
		$L_o / L_a = 6.63 \text{ mH}$	IIIC (E, F, G)		
Out B	8 - 10	$L_o / L_a = 1.42 \text{ mH}$	IIC (A, B)	\geq	$L_i / L_i \text{ device} + L \text{ cable}$
		$L_o / L_a = 12.30 \text{ mH}$	IIB (C)		
		$L_o / L_a = 24.60 \text{ mH}$	IIA (D)		
		$L_o / L_a = 40.35 \text{ mH}$	I		
		$L_o / L_a = 12.30 \text{ mH}$	IIIC (E, F, G)		
Out C	9 - 10	$L_o / L_a = 2.54 \text{ mH}$	IIC (A, B)	\geq	$L_i / L_i \text{ device} + L \text{ cable}$
		$L_o / L_a = 16.7 \text{ mH}$	IIB (C)		
		$L_o / L_a = 33.5 \text{ mH}$	IIA (D)		
		$L_o / L_a = 55.09 \text{ mH}$	I		
		$L_o / L_a = 16.7 \text{ mH}$	IIIC (E, F, G)		

For installations in which both the C_i and L_i of the Intrinsically Safe apparatus exceed 1% of the C_o and L_o parameters of the Associated Apparatus (excluding the cable), then 50% of C_o and L_o parameters are applicable and shall not be exceeded (50% of the C_o and L_o become the limits which must include the cable such that $C_i \text{ device} + C \text{ cable} \leq 50\% \text{ of } C_o$ and $L_i \text{ device} + L \text{ cable} \leq 50\% \text{ of } L_o$). The reduced capacitance of the external circuit (including cable) shall not be greater than $1 \mu\text{F}$ for Groups I, IIA, IIB and 600 nF for Group IIC. If the cable parameters are unknown, the following value may be used: Capacitance 200 pF per meter (60 pF per foot), Inductance $1 \mu\text{H}$ per meter ($0.20 \mu\text{H}$ per foot).

Out A	7 - 10	Lo / Ro = 39.2 μ H/ Ω	IIC (A, B)	≥	Li / Ri device and L cable / R cable
		Lo / Ro = 156.8 μ H/ Ω	IIB (C)		
		Lo / Ro = 313.6 μ H/ Ω	IIA (D)		
		Lo / Ro = 514.6 μ H/ Ω	I		
		Lo / Ro = 156.8 μ H/ Ω	IIIC (E, F, G)		
Out B	8 - 10	Lo / Ro = 53.3 μ H/ Ω	IIC (A, B)	≥	Li / Ri device and L cable / R cable
		Lo / Ro = 213.5 μ H/ Ω	IIB (C)		
		Lo / Ro = 427.0 μ H/ Ω	IIA (D)		
		Lo / Ro = 700.6 μ H/ Ω	I		
		Lo / Ro = 213.5 μ H/ Ω	IIIC (E, F, G)		
Out C	9 - 10	Lo / Ro = 62.3 μ H/ Ω	IIC (A, B)	≥	Li / Ri device and L cable / R cable
		Lo / Ro = 249.4 μ H/ Ω	IIB (C)		
		Lo / Ro = 498.9 μ H/ Ω	IIA (D)		
		Lo / Ro = 818.5 μ H/ Ω	I		
		Lo / Ro = 249.4 μ H/ Ω	IIIC (E, F, G)		

Function Diagram

HAZARDOUS AREA ZONE 0 (ZONE 20) GROUP IIC,
HAZARDOUS LOCATIONS CLASS I, DIVISION 1, GROUPS A, B, C, D,
CLASS II, DIVISION 1, GROUPS E, F, G, CLASS III, DIVISION 1,
CLASS I, ZONE 0, GROUP IIC

SAFE AREA, ZONE 2 GROUP IIC T4,
NON HAZARDOUS LOCATIONS, CLASS I, DIVISION 2,
GROUPS A, B, C, D T-Code T4, CLASS I, ZONE 2, GROUP IIC T4

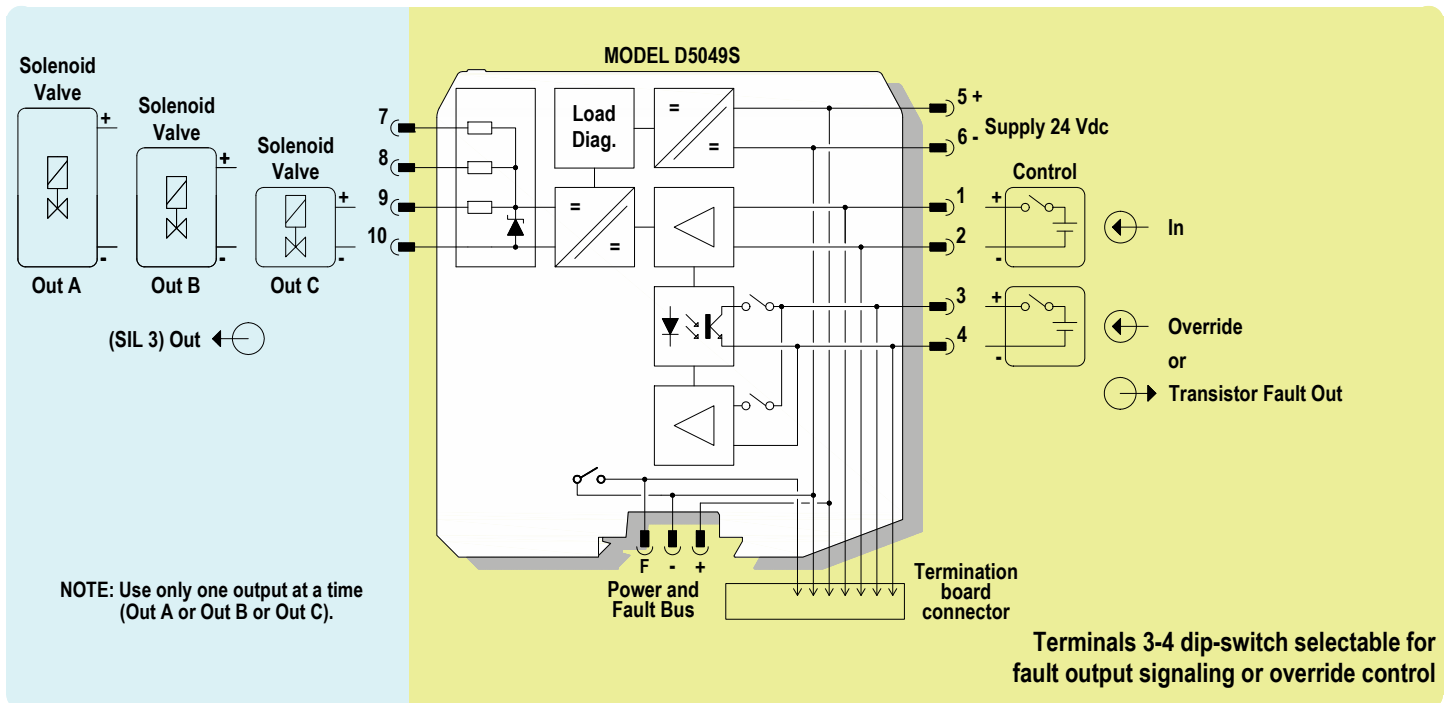

Warning

D5049 series is isolated Intrinsically Safe Associated Apparatus installed into standard EN/IEC60715 TH 35 DIN-Rail located in Safe Area or Zone 2, Group IIC, Temperature T4, Hazardous Area within the specified operating temperature limits Tamb -40 to +70 °C, and connected to equipment with a maximum limit for AC power supply Um of 250 Vrms. Not to be connected to control equipment that uses or generates more than 250 Vrms or Vdc with respect to earth ground. D5049 series must be installed, operated and maintained only by qualified personnel, in accordance to the relevant national/international installation standards (e.g. IEC/EN60079-14 Electrical apparatus for explosive gas atmospheres - Part 14: Electrical installations in hazardous areas (other than mines)), following the established installation rules, particular care shall be given to segregation and clear identification of I.S. conductors from non I.S. ones. De-energize power source (turn off power supply voltage) before plug or unplug the terminal blocks when installed in Hazardous Area or unless area is known to be nonhazardous. **Warning: substitution of components may impair Intrinsic Safety and suitability for Zone 2.** **Explosion Hazard: to prevent ignition of flammable or combustible atmospheres, disconnect power before servicing or unless area is known to be nonhazardous.** Failure to properly installation or use of the equipment may risk to damage the unit or severe personal injury. The unit cannot be repaired by the end user and must be returned to the manufacturer or his authorized representative. Any unauthorized modification must be avoided.

Operation

The single channel Bus Powered Digital Output Isolator, D5049S, is suitable for driving solenoid valves, visual or audible alarms to alert a plant operator, or other process control devices in Hazardous Area from a driving signal in Safe Area. It can also be used as a controllable supply to power measuring or process control equipment. Its use is allowed in applications requiring up to SIL 3 level (according to IEC 61508) in safety related systems for high risk industries. The Safety PLC or DCS driving signal controls the field device through the D5049S, which provides isolation and is capable of monitoring the conditions of the line. Short and open circuit diagnostic monitoring, dip-switch selectable, operates irrespective of the output condition and provides LED indication and NC transistor output signaling. When fault is detected output is de-energized until normal condition is restored. An override input, dip-switch selectable, is provided to permit a safety system to override the control signal. When enabled, a low input voltage always de-energizes the field device regardless of the input signal. Three basic output circuits are selectable, with different safety parameters, to interface the majority of devices on the market. The selection among the three output characteristics is obtained by connecting the field device to a different terminal block. Presence of supply, status of output, as well as integrity or fault condition of device and connecting line are displayed by signaling LEDs (green for power, yellow for status, red for fault).

Application of D5049S for NE load

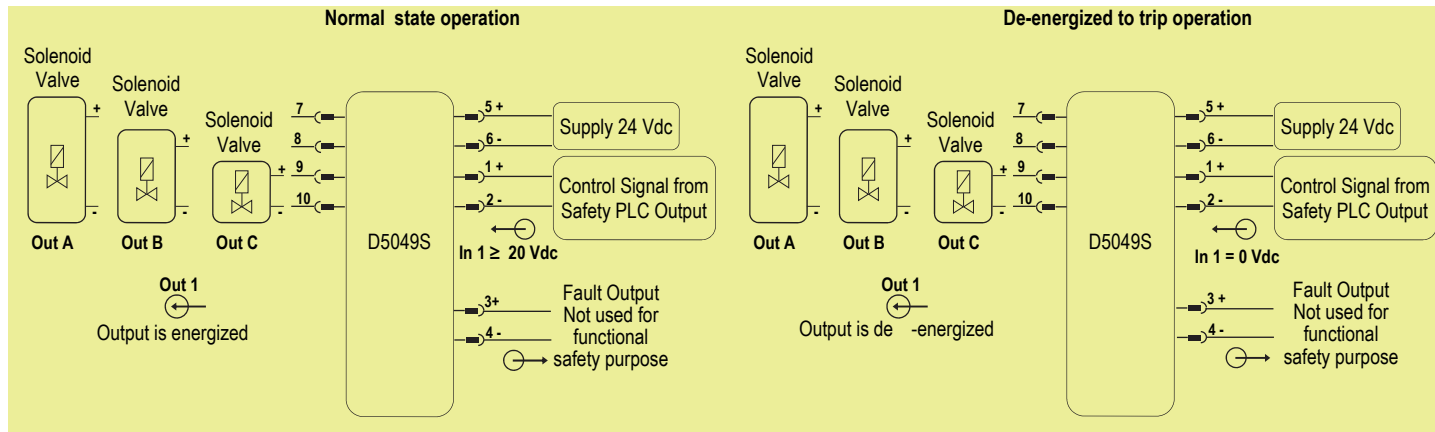

Description:

The D5049S is a single channel digital output drivers, Bus powered for NE (Normally Energized) loads. The Safety PLC or DCS control signal enables the field devices through the single channel digital output driver D5049S (1 intrinsic safety channel, Bus Powered), which provides the electrical isolation between Supply - Input and Output. The presence of the input control signal is also indicated by a yellow LED on the front panel. In order to interface the majority of field devices available on the market, two basic output circuits with different safety parameters (outputs A, B and C) are provided for channel. The selection among the three output characteristics is obtained by connecting the field devices to a different couple of terminal blocks. The field line and load fault detection is enabled, the override input is disabled and direct In / Out operation is selected, setting the internal DIP-switches in the following modes

SW1 Dip-switch position	1	2	3	4
ON / OFF state	ON	-	-	-

SW2 Dip-switch position	1	2	3	4
ON / OFF state	ON	ON	OFF	OFF

The module is powered by connecting 24 Vdc power supply to Pins 5 (+ positive) and 6 (- negative).

The Control signal from Safety PLC Outputs is applied to Pins 1 - 2.

The Output NE load is applied to Pins 7 - 10 or 8 - 10 or 9-10.

The following table describes the state (energized or de-energized) of the output when the Control signal is in the High (24 Vdc) or Low (0 Vdc) state.

Operation	Input Signal State Pins 1 - 2	Output State Pins 7-10 (Out A) or 8-10 (Out B) or 9-10 (Out C)
Normal	High (20 to 30 Vdc)	Energized
Trip	Low (0 Vdc)	De-energized (as safe state condition)

Safety Function and Failure behavior:

D5049S is considered to be operating in Low Demand mode, as a Type A module, having Hardware Fault Tolerance (HFT) = 0.

The failure behaviour of D5049S for NE loads is described by the following definitions:

- Fail-Safe State: it is defined as the output being de-energized;
- Fail Safe: failure mode that causes the module / (sub)system to go to the defined fail-safe state without a demand from the process;
- Fail Dangerous: failure mode that does not respond to a demand from the process (i.e. being unable to go to the defined fail-safe state), so that the output remains energized ;
- Fail "No Effect": failure mode of a component that plays a part in implementing the safety function but that is neither a safe failure nor a dangerous failure. When calculating the SFF, this failure mode is not taken into account.
- Fail "Not part": failure mode of a component that is not part of the safety function but part of the circuit diagram and is listed for completeness. When calculating the SFF, this failure mode is not taken into account.

Failure rate data: taken from Siemens Standard SN29500.

Failure rate table:

Failure category	Failure rates (FIT)
λ_{dd} = Total Dangerous Detected failures	0.00
λ_{du} = Total Dangerous Undetected failures	1.90
λ_{sd} = Total Safe Detected failures	0.00
λ_{su} = Total Safe Undetected failures	171.63
$\lambda_{tot\ safe}$ = Total Failure Rate (Safety Function) = $\lambda_{dd} + \lambda_{du} + \lambda_{sd} + \lambda_{su}$	173.53
MTBF (safety function, single channel) = $(1 / \lambda_{tot\ safe}) + MTTR$ (8 hours)	657 years
$\lambda_{no\ effect}$ = "No effect" failures	274.47
$\lambda_{not\ part}$ = "Not Part" failures	31.60
$\lambda_{tot\ device}$ = Total Failure Rate (Device) = $\lambda_{tot\ safe} + \lambda_{no\ effect} + \lambda_{not\ part}$	479.60
MTBF (device, single channel) = $(1 / \lambda_{tot\ device}) + MTTR$ (8 hours)	238 years

Failure rates table according to IEC 61508:2010 Ed.2 :

λ_{sd}	λ_{su}	λ_{dd}	λ_{du}	SFF
0.00 FIT	171.63 FIT	0.00 FIT	1.90 FIT	98.91%

PFDavg vs T[Proof] table (assuming Proof Test coverage of 99%), with determination of SIL supposing module contributes ≤10% of total SIF dangerous failures:

T[Proof] = 1 year	T[Proof] = 12 years
PFDavg = 8.32 E-06 Valid for SIL 3	PFDavg = 9.98 E-05 Valid for SIL 3

PFDavg vs T[Proof] table (assuming Proof Test coverage of 99%), with determination of SIL supposing module contributes >10% of total SIF dangerous failures:

T[Proof] = 20 years
PFDavg = 1.66 E-04 Valid for SIL 3

Systematic capability SIL 3

Testing procedure at T-proof

The proof test must be performed to reveal dangerous faults which cannot be otherwise detected. This means that it is necessary to specify how dangerous undetected faults, which have been noted during the FMEDA analysis, can be revealed during the proof test.

The **Proof Test** consists of the following steps

Steps	Action
1	Bypass the Safety-related PLC or take any other appropriate action to avoid a false trip.
2	<p>Set the following configuration:</p> <ul style="list-style-type: none"> □ SW1 DIP-switch: SW1-1 = OFF (to disable the field line and load fault detection), SW1-2 = SW1-3 = SW1-4 = ON or OFF (because they are not used); □ SW2 DIP-switch: SW2-1 = ON (direct IN/OUT transfer function), SW2-2 = ON, SW2-3 = OFF, SW2-4 = OFF (to enable fault output and disable override input functionality). <p>The series connection of a 1 kΩ load resistor and an ammeter must be connected, in parallel with a voltmeter, to one of the module outputs (starting with Out A, then going on with Out B and finally proceeding with Out C). Supply the D5049S module at 24 Vdc. Then, apply the control signal to the module input channel, which can have the following two states:</p> <ul style="list-style-type: none"> □ OFF = 0 Vdc, implying that the load current is 0 mA and the load voltage is 0 V because the 1 kΩ load resistor must be de-energized in accordance with the control input signal OFF state; □ ON = 24 Vdc, so that the 1 kΩ load resistor must be energized, with the following current and voltage values: 17.5 ÷ 18.5 mA and 17.5 ÷ 18.5 V (for Out A); 16.5 ÷ 17.5 mA and 16.5 ÷ 17.5 V (for Out B); 16 ÷ 17 mA and 16 ÷ 17 V (for Out C). <p>In addition, disconnect the 1 kΩ load resistor from the output channel in order to generate an open / short output circuit, when the line and load fault detection is disabled and the control signal is ON:</p> <ul style="list-style-type: none"> □ open circuit: connect only the voltmeter in parallel to the output, so that the output voltage is within the 21 ÷ 21.5 V range; □ short circuit: connect only the ammeter in parallel to the output, so that the output current is within the 53 ÷ 57 mA range.
3	<p>Consider the configuration setup defined in the previous proof test step (2) and change the SW1-1 DIP-switch from the OFF to the ON position, in order to enable the field line and load fault detection. Supply the D5049S module at 24 Vdc, apply a 24 Vdc = ON control signal to the module input channel, then connect an ohmmeter to the fault output and another one to the Fault Bus output.</p> <p>In the presence of the 1 kΩ load resistor connected to the output channel, the fault red LED is turned off, the fault output is closed (that is, there is presence of ohmic continuity) and the Fault Bus output is open (that is, there is absence of ohmic continuity) because no line or load fault is detected.</p> <p>Now, disconnect the 1 kΩ load resistor from the output channel in order to generate a line or load fault (open / short circuit fault), so that fault red LED is turned on, the fault output is open (that is, there is absence of ohmic continuity) and the Fault Bus output is closed (that is, there is presence of ohmic continuity).</p> <p>Then, generate an open or short output circuit fault performing the following setup changes:</p> <ul style="list-style-type: none"> □ open circuit: connect only the voltmeter in parallel to the module output, so that the load voltage is within the 4 ÷ 4.5 V range (open circuit voltage of the diagnostic circuit); □ short circuit: connect only the ammeter in parallel to the module output, so that the load current is < 1 mA (short circuit current of the diagnostic circuit). <p>These results are also valid when the control signal state is OFF and the channel is turned off, because the fault diagnostic circuit (if enabled) is always active independently from the channel state.</p>
4	<p>Consider the configuration setup defined in the previous proof test step (2) and change SW1-1 DIP-switch from the OFF to the ON position, in order to enable the field line and load fault detection. Replace the series connection of a 1 kΩ load resistor and an ammeter with a current calibrator (set to 45 mA). This current generator and a voltmeter are connected in parallel to one of the module outputs (starting with Out A, then going on with Out B and finally proceeding with Out C). Supply the D5049S or D1049S module at 24 Vdc and apply a 24 Vdc = ON control signal to the module input channel, verifying the following load voltage values: 13 ÷ 13.5 V (for Out A), 10.2 ÷ 10.7 V (for Out B) and 8.5 ÷ 9 V (for Out C).</p>
5	Restore the loop to full operation.
6	Remove the bypass from the Safety-related PLC or restore normal operation.

This test reveals almost 99 % of all possible Dangerous Undetected failures in the digital output module.

Installation

D5049 series is a Digital Output Driver housed in a plastic enclosure suitable for installation on EN/IEC60715 TH 35 DIN-Rail, with or without Power Bus or on customized Termination Board. D5049 series can be mounted with any orientation over the entire ambient temperature range.

Electrical connection are accommodated by polarized plug-in removable screw terminal blocks which can be plugged in/out into a powered unit without suffering or causing any damage **(for Zone 2 installations check the area to be nonhazardous before servicing)**. Connect only one individual conductor per each clamping point, use conductors up to 2.5 mm² (13 AWG) and a torque value of 0.5-0.6 Nm. The wiring cables have to be proportionate in base to the current and the length of the cable.

In case of installation in zone 2, the connecting cables of non-intrinsically safe circuits must be safely routed in a cable duct or similar. The distance between the pluggable connection terminal and the cable duct should not exceed 500 mm cable length.

On the section "Function Diagram" and enclosure side a block diagram identifies all connections. Identify the function and location of each connection terminal using the wiring diagram on the corresponding section, as an example:

Connect 24 Vdc power supply positive at terminal "5" and negative at terminal "6".

Connect positive input at terminal "1" and negative input at "2".

Connect positive transistor fault output or positive input override at terminal "3" and negative at "4".

Connect positive output A for solenoid valve at terminal "7" and negative at "10" or output B at terminal "8" and negative at "10" or output C at terminal "9" and negative at "10".

Intrinsically Safe conductors must be identified and segregated from non I.S. and wired in accordance to the relevant national/international installation standards (e.g. EN/IEC60079-14 Electrical apparatus for explosive gas atmospheres - Part 14: Electrical installations in hazardous areas (other than mines)), make sure that conductors are well isolated from each other and do not produce any unintentional connection.

Connect SPST fault output transistors checking the load rating to be within the maximum rating (100 mA at 35 Vdc (≤ 1.5 V voltage drop)).

The enclosure provides, according to EN60529, an IP20 minimum degree of protection (or similar to NEMA Standard 250 type 1). The equipment shall only be used in an area of at least pollution degree 2, as defined in IEC 60664-1. When installed in EU Zone 2, the unit shall be installed in an enclosure that provides a minimum ingress protection of IP54 in accordance with IEC 60079-0. When installed in a Class I, Zone 2 Hazardous Location, the unit shall be mounted in a supplemental AEx or Ex enclosure that provides a degree of protection not less than IP54 in accordance with UL/CSA 60079-0. When installed in a Class I, Division 2 Hazardous Location, the unit shall be mounted in a supplemental enclosure that provides a degree of protection not less than IP54. The enclosure must have a door or cover accessible only by the use of a tool. The end user is responsible to ensure that the operating temperature of the module is not exceeded in the end use application.

Units must be protected against dirt, dust, extreme mechanical (e.g. vibration, impact and shock) and thermal stress, and casual contacts.

If enclosure needs to be cleaned use only a cloth lightly moistened by a mixture of detergent in water.

Electrostatic Hazard: to avoid electrostatic hazard, the enclosure of D5049 series must be cleaned only with a damp or antistatic cloth.

Any penetration of cleaning liquid must be avoided to prevent damage to the unit. Any unauthorized modification must be avoided. D5049 series must be connected to SELV or PELV supplies. All circuits connected to D5049 series must comply with the overvoltage category II (or better) according to EN/IEC60664-1.

Start-up

Before powering the unit check that all wires are properly connected, particularly supply conductors and their polarity, input and output wires, also check that Intrinsically Safe conductors and cable trays are segregated (no direct contacts with other non I.S. conductors) and identified either by color coding, preferably blue, or by marking. Check conductors for exposed wires that could touch each other causing dangerous unwanted shorts. Turn on power, the "power on" green led must be lit, status led must be in accordance with condition of the input line. If possible close and open input line checking the corresponding status and fault leds condition as well as output to be correct.

Configuration

A configuration DIP switches are located on component side of pcb. These switches allows the configuration of input/output relationship, override input and fault detection functions.

D5049S

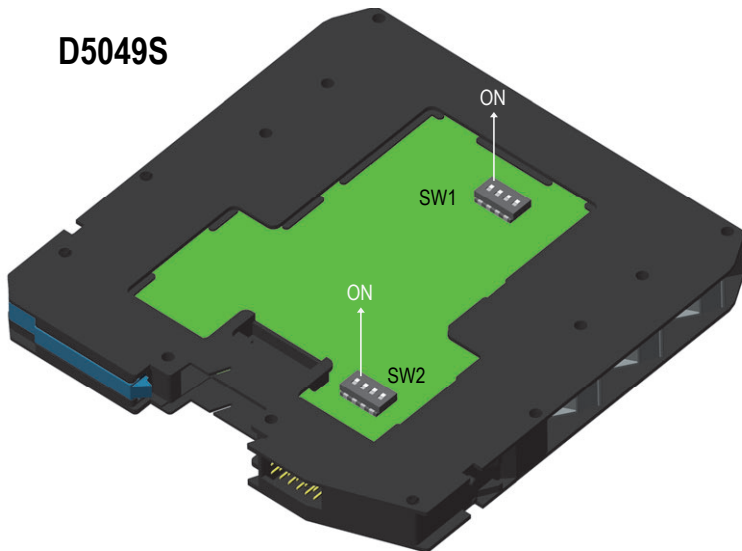

SW1 factory settings
All DIP-switches are ON

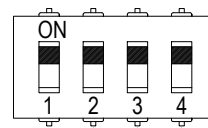

SW2 factory settings
DIP-switches 1-2 are ON
and 3-4 are OFF

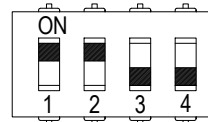

SW1 dip switch configuration

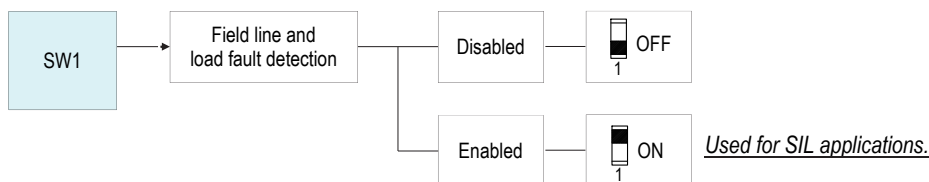
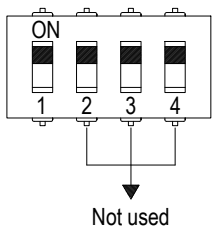

SW2 dip switch configuration

