



INSTRUCTION MANUAL

SIL 3 Switch/Proximity Detector Repeater Relay Output, Termination Board Models D5032S, D5032D



Characteristics

General Description: The single and dual channel Switch/Proximity Detector Repeater, D5032S and D5032D module is a unit suitable for applications requiring SIL 3 level (according to IEC 61508:2010 Ed. 2) in safety related systems for high risk industries.

The unit can be configured for switch or proximity detector (EN60947-5-6, NAMUR), NO or NC and for NE or ND SPST relay output contact.

Each channel enables a Safe Area load to be controlled by a switch, or a proximity detector, located in Hazardous Area.

Fault detection circuit (DIP switch configurable) is available for both proximity sensor and switch equipped with end of line resistors.

In case of fault, when enabled it de-energizes the corresponding output relay and turns the fault LED on; when disabled the corresponding output relay repeats the input line open or closed status as configured.

D5032D is programmable via dip switches as single input and two independent outputs. Out 2 can be programmed for output duplicating Out 1 or Fault detection Out.

In case of duplication, relay actuation can be independently configured for each output.

In case of fault output, relay actuation can be programmed as normally energized or normally de-energized.

Mounting on customized Termination Boards, in Safe Area / Non Hazardous Location or in Zone 2 / Class I, Division 2 or Class I, Zone 2.

Functional Safety Management Certification:

G.M. International is certified by TÜV to conform to IEC61508:2010 part 1 clauses 5-6 for safety related systems up to and included SIL3.



Technical Data

Supply: 24 Vdc nom (18 to 30 Vdc) reverse polarity protected, ripple within voltage limits ≤ 5 Vpp, 2 A time lag fuse internally protected.

Current consumption @ 24 V: 35 mA for 2 channels D5032D, 18 mA for 1 channel D5032S with short circuit input and relay energized, typical.

Power dissipation: 0.85 W for 2 channels D5032D, 0.45 W for 1 channel D5032S with 24 V supply voltage, short circuit input and relay energized, typical.

Isolation (Test Voltage): I.S. In/Out 2.5 KV; I.S. In/Supply 2.5 KV; I.S. In/ I.S. In 500 V; Out/Supply 500 V; Out/Out 500 V.

Input switching current levels: ON ≥ 2.1 mA (1.9 to 6.2 mA range), OFF ≤ 1.2 mA (0.4 to 1.3 mA range), switch current ≈ 1.65 mA ± 0.2 mA hysteresis.

Fault current levels: open fault ≤ 0.2 mA, short fault ≥ 6.8 mA (when enabled both faults de-energize channel relay with single channel unit D5032S or de-energize channel relay with D5032D used as dual channel unit or actuate the fault relay out with D5032D used as fault signaling unit).

Input equivalent source: 8 V 1 K Ω typical (8 V no load, 8 mA short circuit).

Output: voltage free SPST relay contact.

Contact material: Ag Alloy (Cd free), gold plated.

Contact rating: 4 A 250 Vac 1000 VA, 4 A 250 Vdc 120 W (resistive load). Min. switching current 1 mA.

Mechanical / Electrical life: 5 * 10⁶ / 1 * 10⁶ operation, typical.

Operate / Release time: 8 / 4 ms typical.

Bounce time NO / NC contact: 3 / 8 ms typical.

Frequency response: 10 Hz maximum.

Compatibility:

CE mark compliant, conforms to Directive: 2014/34/EU ATEX, 2014/30/EU EMC, 2014/35/EU LVD, 2011/65/EU RoHS.

Environmental conditions:

Operating: temperature limits - 40 to + 70 °C, relative humidity 95 %, up to 55 °C.

Storage: temperature limits - 45 to + 80 °C.

Max altitude: 2000 m a.s.l.

Safety Description:



ATEX: II 3(1)G Ex ec nC [ia Ga] IIC T4 Gc, II (1)D [Ex ia Da] IIIC, I (M1) [Ex ia Ma] I. **IECEX / INMETRO:** Ex ec nC [ia Ga] IIC T4 Gc, [Ex ia Da] IIIC, [Ex ia Ma] I,

UL: NI / I / 2 / ABCD / T4, AIS / I, II, III / 1 / ABCDEFG, AEx nA nC [ia Ga] IIC T4 Gc. **C-UL:** NI / I / 2 / ABCD / T4, AIS / I, II, III / 1 / ABCDEFG, Ex nA nC [ia Ga] IIC T4 Gc

FM: NI-AIS / I / 2 / ABCD / T4, AIS / I, II, III / 1 / ABCDEFG, I / 2 / AEx nA nC [ia] / IIC / T4. **FMC:** NI-AIS / I / 2 / ABCD / T4, AIS / I, II, III / 1 / ABCDEFG, I / 2 / Ex nA nC [ia] / IIC / T4

EAC-EX: 2Ex ec nC [ia Ga] IIC T4 Gc X; [Ex ia Da] IIIC X; [Ex ia Ma] I X

CCC: Ex ec nC [ia Ga] IIC T4 Gc; [Ex ia Da] IIC; [Ex ia Ma] IIC

associated apparatus and non-sparking electrical equipment.

Uo/Voc = 10.5 V, Io/Isc = 22 mA, Po/Po = 56 mW at terminals 7-8, 9-10.

Um = 250 Vrms, -40 °C \leq Ta \leq 70 °C.

Approvals:

BVS 10 ATEX E 113 X conforms to EN60079-0, EN60079-7, EN60079-11, EN60079-15.

IECEX BVS 10.0072 X conforms to IEC60079-0, IEC60079-7, IEC60079-11, IEC60079-15.

INMETRO DNV 13.0109 X conforms to ABNT NBR IEC60079-0, ABNT NBR IEC60079-7, ABNT NBR IEC60079-11, ABNT NBR IEC60079-15.

UL & C-UL E222308 conforms to UL913, UL 60079-0, UL60079-11, UL60079-15,

ANSI/ISA 12.12.01 for UL and CSA-C22.2 No.157-92, CSA-E60079-0, CSA-E60079-11, CSA-C22.2 No. 213 and CSA-E60079-15 for C-UL.

FM 3046304 and FMC 3046304C conforms to Class 3600, 3610, 3810, 3611,

ANSI/ISA-60079-0, ANSI/ISA-60079-11, ANSI/ISA-60079-15, C22.2 No.142, C22.2 No.157, C22.2 No.213, C22.2 No. 60079-0, C22.2 No. 60079-11, C22.2 No. 60079-15.

EA3C RU C-IT.AA87.B.01310/24 conforms to GOST 31610.0, GOST 31610.7, GOST 31610.11, GOST 31610.15.

CCC n. 2020322316000978 conforms to GB/T 3836.1, GB/T 3836.3, GB/T 3834.4, GB/T 3836.8

TÜV Certificate No. C-IS-236198-04, SIL 2 / SIL 3 conforms to IEC61508:2010 Ed. 2.

SIL 3 Functional Safety TÜV Certificate conforms to IEC61508:2010 Ed.2, for Management of Functional Safety.

DNV Type Approval Certificate No. TAA00001U0 and KR No.MIL20769-EL002 Certificates for maritime applications.

Mounting:

on customized Termination Board.

Weight: about 125 g D5032D, 115 g D5032S.

Connection: by polarized plug-in disconnect screw terminal blocks to accommodate terminations up to 2.5 mm².

Location: installation in Safe Area/Non Hazardous Locations or Zone 2, Group IIC T4 or Class I, Division 2, Group A,B,C,D, T4 or Class I, Zone 2, Group IIC, T4.

Protection class: IP 20.

Dimensions: Width 12.5 mm, Depth 123 mm, Height 120 mm.

Ordering Information

| | | |
|------------|-------|---|
| Model: | D5032 | |
| 1 channel | | S |
| 2 channels | | D |

Front Panel and Features

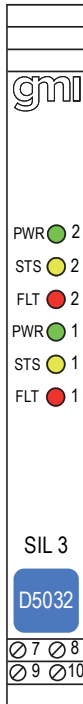

- SIL 3 according to IEC 61508:2010 Ed. 2 for Tproof = 2 / 10 years ($\leq 10\%$ / $> 10\%$ of total SIF), considering 100 mA max contact current.
- SIL 2 according to IEC 61508:2010 Ed. 2 for Tproof = 20 years ($\leq 10\%$ of total SIF), considering 100 mA max contact current.
- PFDavg (1 year) 4.92 E-05, SFF 90.06 %, with independent channel configuration.
PFDavg (1 year) 4.96 E-05, SFF 93.16 %, with D5032D used as duplicator (both channels) or as fault indicator (only 1st ch.).
PFDavg (1 year) 4.66 E-05, SFF 93.53 %, with D5032D used as fault indicator (only 2nd ch.).
- Systematic capability SIL 3
- 2 fully independent channels.
- Input from Zone 0 (Zone 20), installation in Zone 2.
- NO/NC switch/proximity Detector Input, NE/ND relay actuation mode.
- Field open and short circuit detection.
- Three port isolation, Input/Output/Supply.
- EMC Compatibility to EN61000-6-2, EN61000-6-4, EN61326-1, EN61326-3-1 for safety system.
- In-field programmability by DIP Switch.
- ATEX, IECEx, UL & C-UL, FM, FMC, INMETRO, EAC-EX, CCC, TÜV Certifications.
- TÜV Functional Safety Certification.
- Type Approval Certificate DNV and KR for maritime applications.
- High Density, two channels per unit.
- Simplified installation using customized Termination Boards.
- 250 Vrms (Um) max. voltage allowed to the instruments associated with the barrier.

Terminal block connections

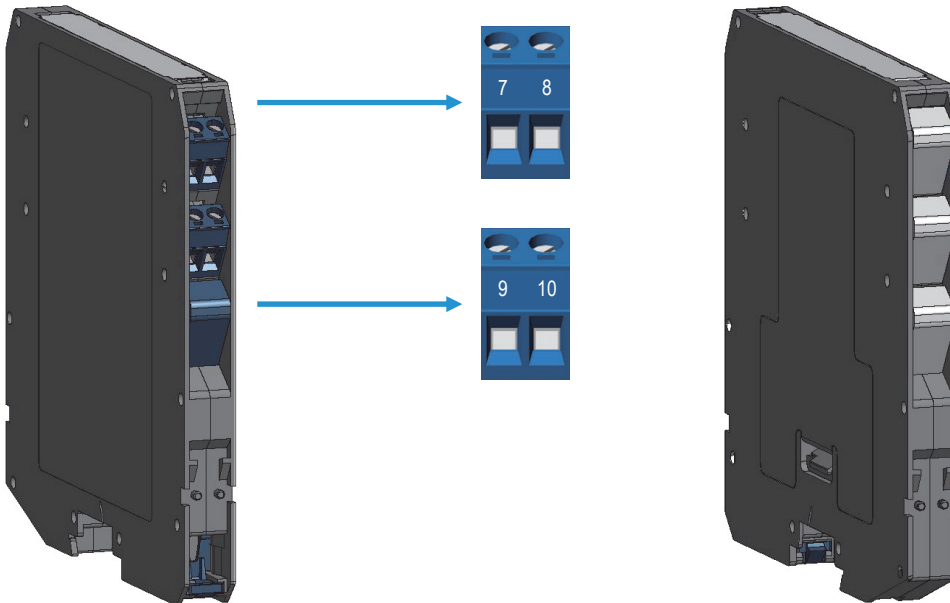

HAZARDOUS AREA

- | | |
|-----------|--|
| 7 | + Input Ch 1 for Proximity or Voltage free Contact |
| 8 | - Input Ch 1 for Proximity or Voltage free Contact |
| 9 | + Input Ch 2 for Proximity or Voltage free Contact |
| 10 | - Input Ch 2 for Proximity or Voltage free Contact |

Parameters Table

In the system safety analysis, always check the Hazardous Area/Hazardous Locations devices to conform with the related system documentation, if the device is Intrinsically Safe check its suitability for the Hazardous Area/Hazardous Locations and group encountered and that its maximum allowable voltage, current, power (U_i/V_{max} , I_i/I_{max} , P_i/P_i) are not exceeded by the safety parameters (U_o/V_{oc} , I_o/I_{sc} , P_o/P_o) of the D5032 series Associated Apparatus connected to it. Also consider the maximum operating temperature of the field device, check that added connecting cable and field device capacitance and inductance do not exceed the limits (C_o/C_a , L_o/L_a , L_o/R_o) given in the Associated Apparatus parameters for the effective group. See parameters indicated in the table below:

| D5032 Terminals | | D5032 Associated Apparatus Parameters | | Must be | Hazardous Area/ Hazardous Locations Device Parameters |
|-----------------|--------|--|----------------|---------|---|
| Ch1 | 7 - 8 | $U_o / V_{oc} = 10.5 \text{ V}$ | | \leq | U_i / V_{max} |
| Ch2 | 9 - 10 | | | | |
| Ch1 | 7 - 8 | $I_o / I_{sc} = 22 \text{ mA}$ | | \leq | I_i / I_{max} |
| Ch2 | 9 - 10 | | | | |
| Ch1 | 7 - 8 | $P_o / P_o = 56 \text{ mW}$ | | \leq | P_i / P_i |
| Ch2 | 9 - 10 | | | | |
| D5032 Terminals | | D5032 Associated Apparatus Parameters Cenelec (US) | | Must be | Hazardous Area/ Hazardous Locations Device + Cable Parameters |
| Ch1 | 7 - 8 | $C_o / C_a = 2.4 \mu\text{F}$ | IIC (A, B) | \geq | $C_i / C_i \text{ device} + C \text{ cable}$ |
| Ch2 | 9 - 10 | $C_o / C_a = 16.8 \mu\text{F}$ | IIB (C) | | |
| | | $C_o / C_a = 75 \mu\text{F}$ | IIA (D) | | |
| | | $C_o / C_a = 66 \mu\text{F}$ | I | | |
| | | $C_o / C_a = 16.8 \mu\text{F}$ | IIIC (E, F, G) | | |
| Ch1 | 7 - 8 | $L_o / L_a = 78.3 \text{ mH}$ | IIC (A, B) | \geq | $L_i / L_i \text{ device} + L \text{ cable}$ |
| Ch2 | 9 - 10 | $L_o / L_a = 313.4 \text{ mH}$ | IIB (C) | | |
| | | $L_o / L_a = 626.9 \text{ mH}$ | IIA (D) | | |
| | | $L_o / L_a = 1028.6 \text{ mH}$ | I | | |
| | | $L_o / L_a = 313.4 \text{ mH}$ | IIIC (E, F, G) | | |
| Ch1 | 7 - 8 | $L_o / R_o = 635.9 \mu\text{H}/\Omega$ | IIC (A, B) | \geq | $L_i / R_i \text{ device and}$ $L \text{ cable} / R \text{ cable}$ |
| Ch2 | 9 - 10 | $L_o / R_o = 2543.9 \mu\text{H}/\Omega$ | IIB (C) | | |
| | | $L_o / R_o = 5087.9 \mu\text{H}/\Omega$ | IIA (D) | | |
| | | $L_o / R_o = 8347.4 \mu\text{H}/\Omega$ | I | | |
| | | $L_o / R_o = 2543.9 \mu\text{H}/\Omega$ | IIIC (E, F, G) | | |

For installations in which both the C_i and L_i of the Intrinsically Safe apparatus exceed 1% of the C_o and L_o parameters of the Associated Apparatus (excluding the cable), then 50% of C_o and L_o parameters are applicable and shall not be exceeded (50% of the C_o and L_o become the limits which must include the cable such that $C_i \text{ device} + C \text{ cable} \leq 50\% \text{ of } C_o$ and $L_i \text{ device} + L \text{ cable} \leq 50\% \text{ of } L_o$). The reduced capacitance of the external circuit (including cable) shall not be greater than $1 \mu\text{F}$ for Groups I, IIA, IIB and 600 nF for Group IIC. If the cable parameters are unknown, the following value may be used: Capacitance 200 pF per meter (60 pF per foot), Inductance $1 \mu\text{H}$ per meter ($0.20 \mu\text{H}$ per foot).

Function Diagram

HAZARDOUS AREA ZONE 0 (ZONE 20) GROUP IIC,
HAZARDOUS LOCATIONS CLASS I, DIVISION 1, GROUPS A, B, C, D,
CLASS II, DIVISION 1, GROUPS E, F, G, CLASS III, DIVISION 1,
CLASS I, ZONE 0, GROUP IIC

SAFE AREA, ZONE 2 GROUP IIC T4,
NON HAZARDOUS LOCATIONS, CLASS I, DIVISION 2,
GROUPS A, B, C, D T-Code T4, CLASS I, ZONE 2, GROUP IIC T4

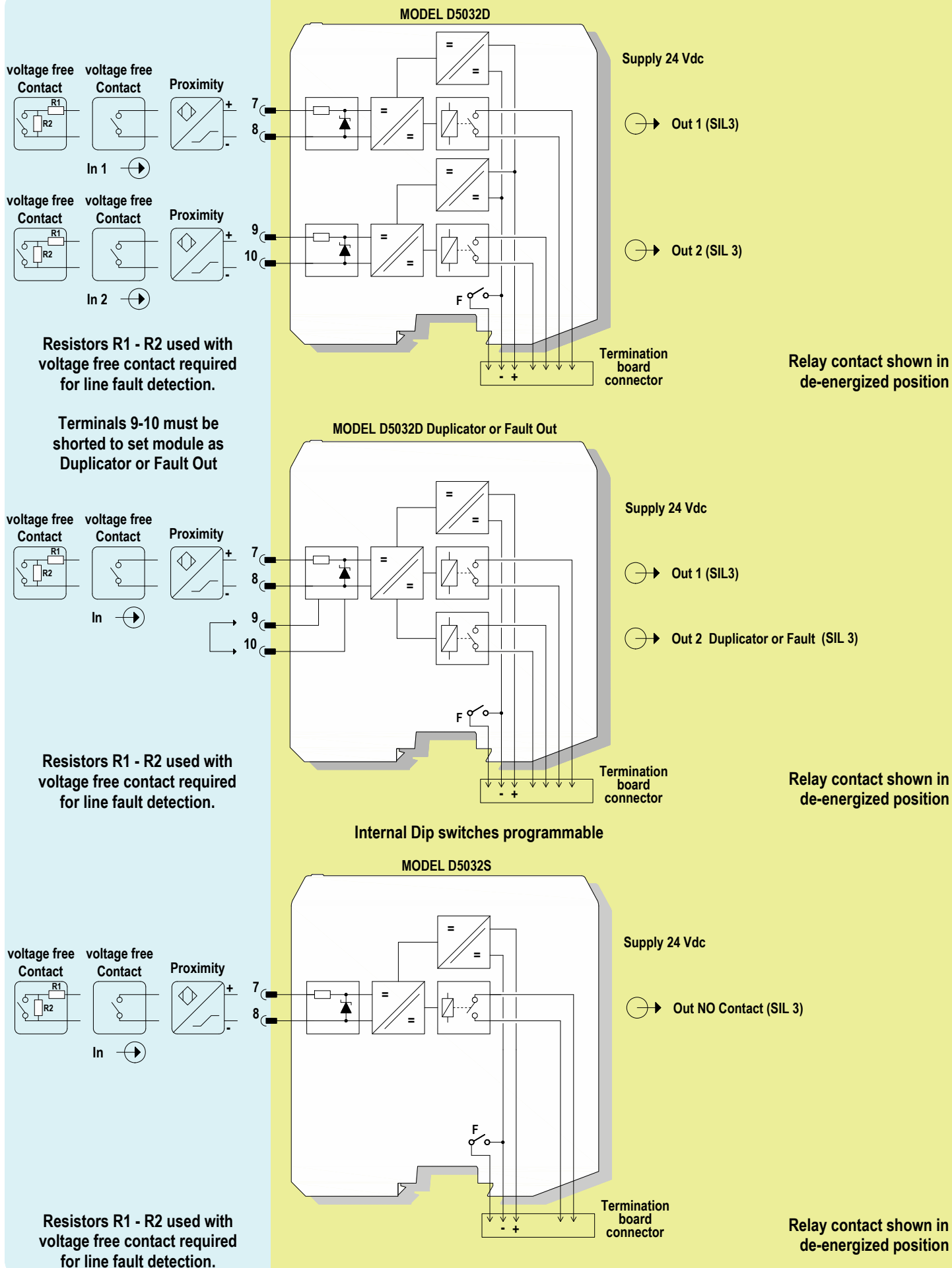

Warning

D5032 series are isolated Intrinsically Safe Associated Apparatus installed into standard EN50022 T35 DIN-Rail located in Safe Area or Zone 2, Group IIC, Temperature T4, Hazardous Area within the specified operating temperature limits Tamb -40 to +70 °C, and connected to equipment with a maximum limit for AC power supply Um of 250 Vrms. Not to be connected to control equipment that uses or generates more than 250 Vrms or Vdc with respect to earth ground.

D5032 series must be installed, operated and maintained only by qualified personnel, in accordance to the relevant national/international installation standards (e.g. IEC/EN60079-14 Electrical apparatus for explosive gas atmospheres - Part 14: Electrical installations in hazardous areas (other than mines)), following the established installation rules, particular care shall be given to segregation and clear identification of I.S. conductors from non I.S. ones.

De-energize power source (turn off power supply voltage) before plug or unplug the terminal blocks when installed in Hazardous Area or unless area is known to be nonhazardous.

Warning: substitution of components may impair Intrinsic Safety and suitability for Zone 2.

Explosion Hazard: to prevent ignition of flammable or combustible atmospheres, disconnect power before servicing or unless area is known to be nonhazardous.

Failure to properly installation or use of the equipment may risk to damage the unit or severe personal injury.

The unit cannot be repaired by the end user and must be returned to the manufacturer or his authorized representative.

Any unauthorized modification must be avoided.

Operation

D5032 module is a unit suitable for applications requiring SIL 3 level (according to IEC 61508) in safety related systems for high risk industries.

The unit can be configured for switch or proximity detector (EN60947-5-6, NAMUR), NO or NC and for NE or ND SPST relay output contact.

Each channel enables a Safe Area load to be controlled by a switch, or a proximity detector, located in Hazardous Area.

Fault detection circuit (DIP switch configurable) is available for both proximity sensor and switch equipped with end of line resistors. In case of fault, when enabled it de-energizes the corresponding output relay and turns the fault LED on; when disabled the corresponding output relay repeats the input line open or closed status as configured.

D5032D is programmable via dip switches as single input and two independent outputs. Out 2 can be programmed for output duplicating Out 1 or Fault detection Out.

In case of duplication, relay actuation can be independently configured for each output.

In case of fault output, relay actuation can be programmed as normally energized or normally de-energized.

Presence of supply power and status of output (energized or de-energized), as well as integrity or fault condition of sensor and connecting line are displayed by signaling LEDs (green for power, yellow for status and red for fault condition).

Note: use of voltage free electrical contacts with fault detection enabled (control equipment) requires, near the switch at the end of the line a R1=1 K Ω typical (470 Ω to 2 K Ω range) resistor in series and a R2=10 k Ω typical (5 K Ω to 15 K Ω range) resistor in parallel to the contacts in order to allow the fault detection circuit to distinguish between a condition of contact close/open and a line open/short circuit fault.

Installation

D5032 series are Switch/Proximity Detector Interface housed in a plastic enclosure suitable for installation on customized Termination Board.

D5032 series can be mounted with any orientation over the entire ambient temperature range.

Electrical connection are accommodated by polarized plug-in removable screw terminal blocks which can be plugged in/out into a powered unit without suffering or causing any damage **(for Zone 2 installations check the area to be nonhazardous before servicing)**. Connect only one individual conductor per each clamping point, use conductors up to 2.5 mm² (13 AWG) and a torque value of 0.5-0.6 Nm. The wiring cables have to be proportionate in base to the current and the length of the cable.

On the section "Function Diagram" and enclosure side a block diagram identifies all connections.

Identify the number of channels of the specific card (e.g. D5032S is a single channel model and D5032D is a dual channel model), the function and location of each connection terminal using the wiring diagram on the corresponding section, as an example:

For Model D5032S, in case of Proximity or Voltage free Contact, connect the wires at terminal "7" for positive and "8" for negative.

For Model D5032D in addition to channel 1 connections above, connect terminal "9" for positive and "10" for negative on channel 2.

Connection for power supply and output are provided by Termination Board connector.

Intrinsically Safe conductors must be identified and segregated from non I.S. and wired in accordance to the relevant national/international installation standards (e.g. EN/IEC60079-14 Electrical apparatus for explosive gas atmospheres - Part 14: Electrical installations in hazardous areas (other than mines)), make sure that conductors are well isolated from each other and do not produce any unintentional connection.

Connect SPST relay contacts checking the load rating to be within the contact maximum rating (100 mA 50 Vac 5 VA, 100 mA 50 Vdc 5 W (resistive load)).

The enclosure provides, according to EN60529, an IP20 minimum degree of protection (or similar to NEMA Standard 250 type 1). The equipment shall only be used in an area of at least pollution degree 2, as defined in IEC 60664-1. When installed in EU Zone 2, the unit shall be installed in an enclosure that provides a minimum ingress protection of IP54 in accordance with IEC 60079-0. When installed in a Class I, Zone 2 Hazardous Location, the unit shall be mounted in a supplemental AEx or Ex enclosure that provides a degree of protection not less than IP54 in accordance with UL/CSA 60079-0. When installed in a Class I, Division 2 Hazardous Location, the unit shall be mounted in a supplemental enclosure that provides a degree of protection not less than IP54. The enclosure must have a door or cover accessible only by the use of a tool. The end user is responsible to ensure that the operating temperature of the module is not exceeded in the end use application.

Units must be protected against dirt, dust, extreme mechanical (e.g. vibration, impact and shock) and thermal stress, and casual contacts.

If enclosure needs to be cleaned use only a cloth lightly moistened by a mixture of detergent in water.

Electrostatic Hazard: to avoid electrostatic hazard, the enclosure of D5032 series must be cleaned only with a damp or antistatic cloth.

Any penetration of cleaning liquid must be avoided to prevent damage to the unit. Any unauthorized modification must be avoided.

D5032 series must be connected to SELV or PELV supplies.

All circuits connected to D5032 series must comply with the overvoltage category II (or better) according to EN/IEC60664-1.

Start-up

Before powering the unit check that all wires are properly connected, particularly supply conductors and their polarity, input and output wires, also check that Intrinsically Safe conductors and cable trays are segregated (no direct contacts with other non I.S. conductors) and identified either by color coding, preferably blue, or by marking. Check conductors for exposed wires that could touch each other causing dangerous unwanted shorts. Turn on power, the "power on" green led must be lit, status and fault led on each channel must be in accordance with condition of the corresponding input line. If possible close and open input lines one at time checking the corresponding status and fault leds condition as well as output to be correct.

D5032D used as double channel

A configuration DIP switch is located on component side of pcb. This switch allows the configuration of input/output relationship, fault detection functions and operating mode.

WARNING: dip-switch 6-7-8 must be set to "OFF" position.

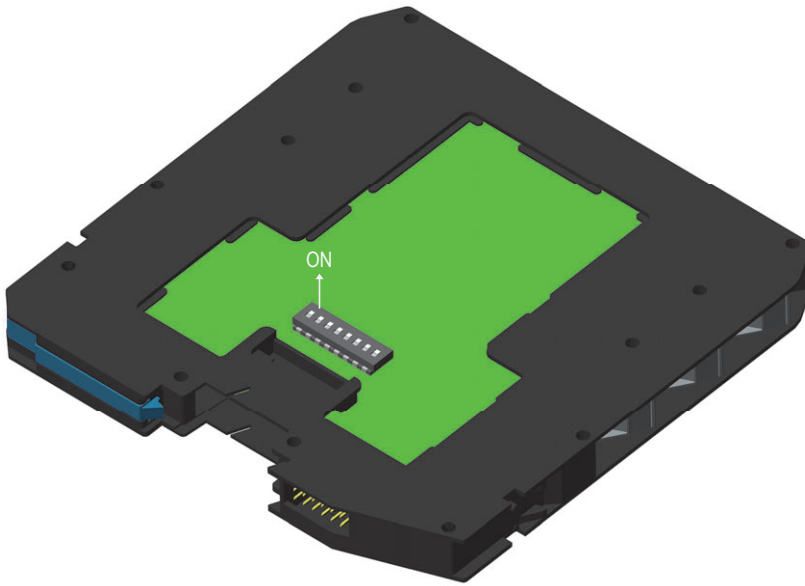

Dip switch factory settings. All Switches are OFF

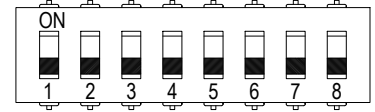

Dip switch configuration

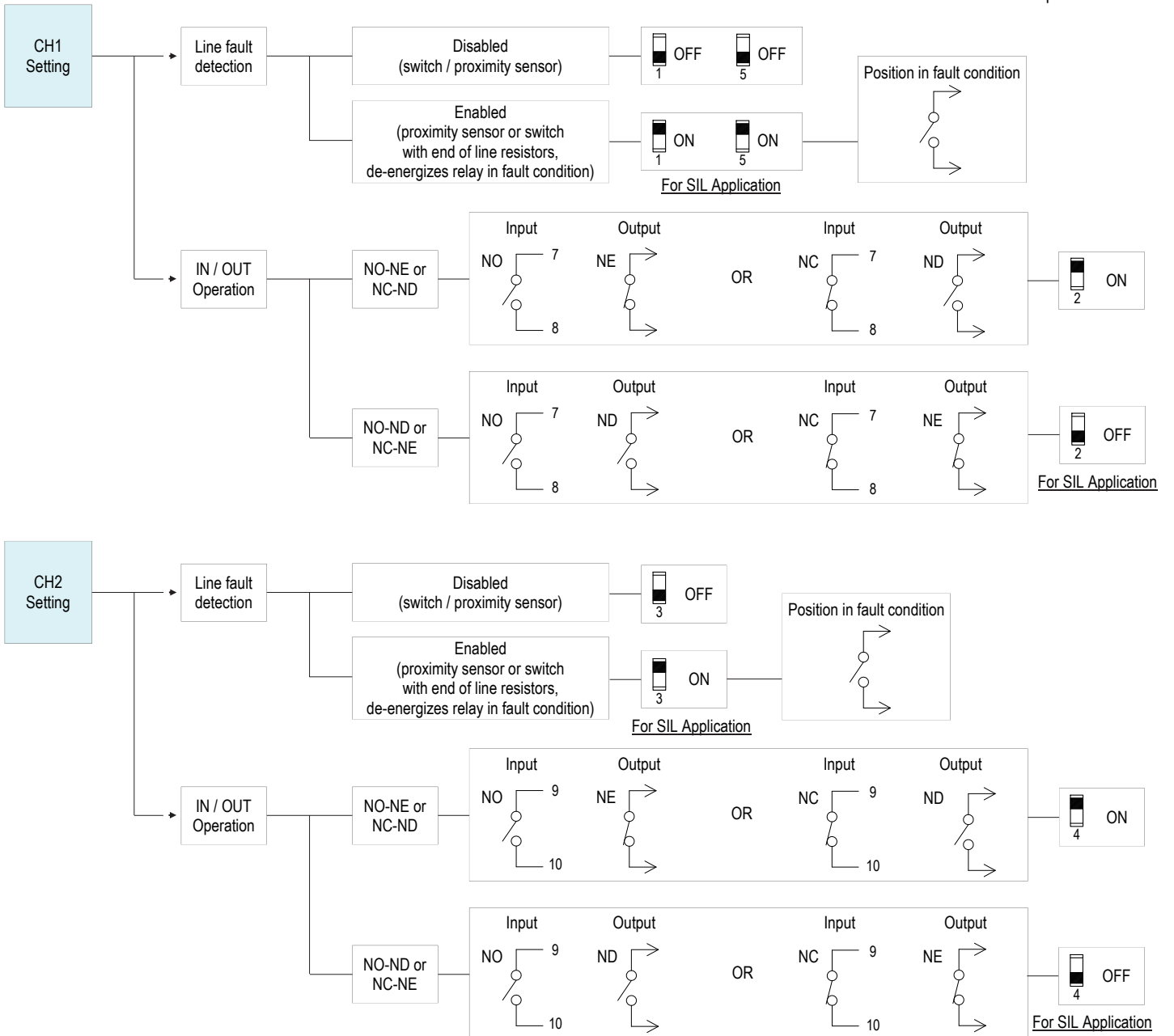
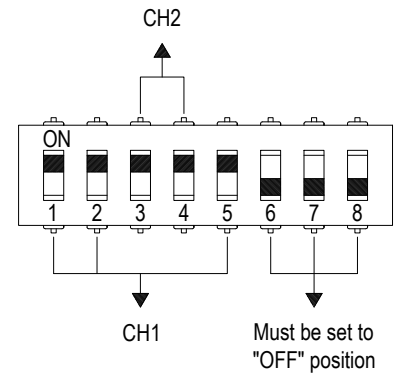

D5032D used as duplicator or fault output

A configuration DIP switch is located on component side of pcb. This switch allows the configuration of input/output relationship, fault detection functions and operating mode.

WARNING: Terminals 9-10 must be shorted to set module as Duplicator or Fault Out.

Dip-switch 3 must be set to "OFF" position.

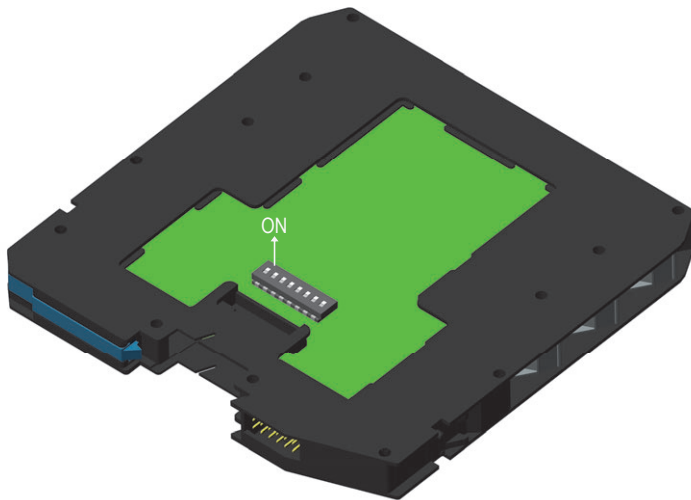

Dip switch factory settings. All Switches are OFF

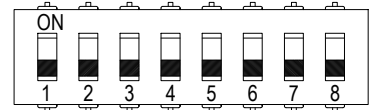

Dip switch configuration

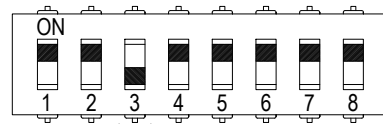

Must be set to "OFF" position

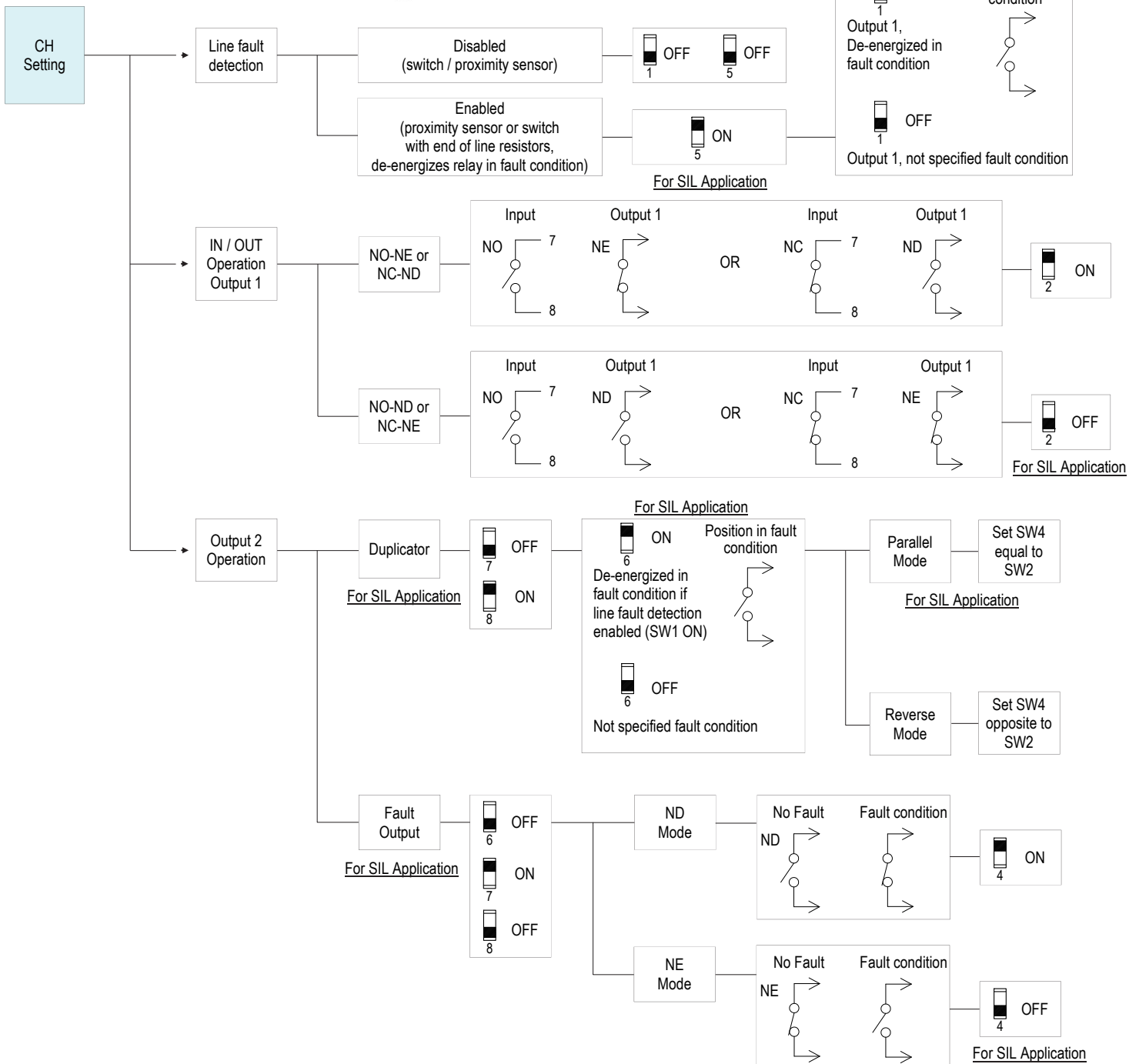

D5032S

A configuration DIP switch is located on component side of pcb. This switch allows the configuration of input/output relationship, fault detection functions and operating mode.

WARNING: Dip-switch 7-8 must be set to "OFF" position.

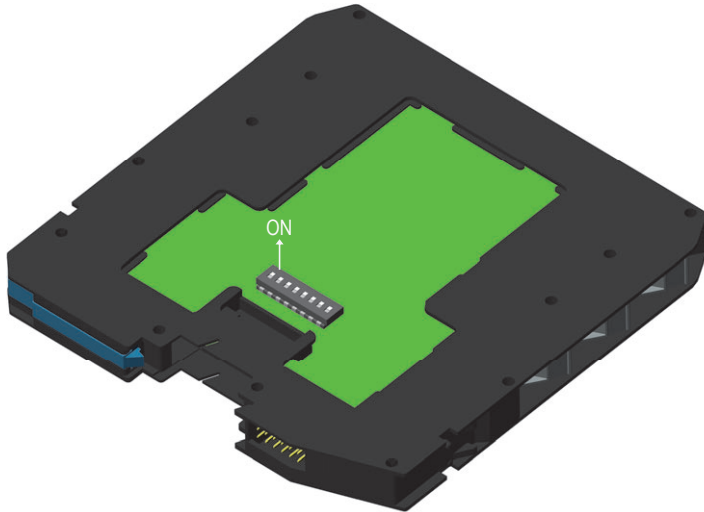

Dip switch factory settings. All Switches are OFF

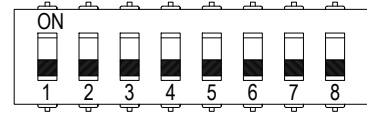

Dip switch configuration

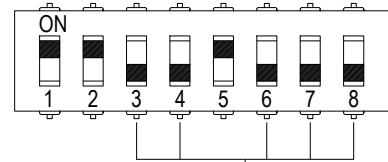

7-8 must be set to "OFF" position
3-4-6 Not used

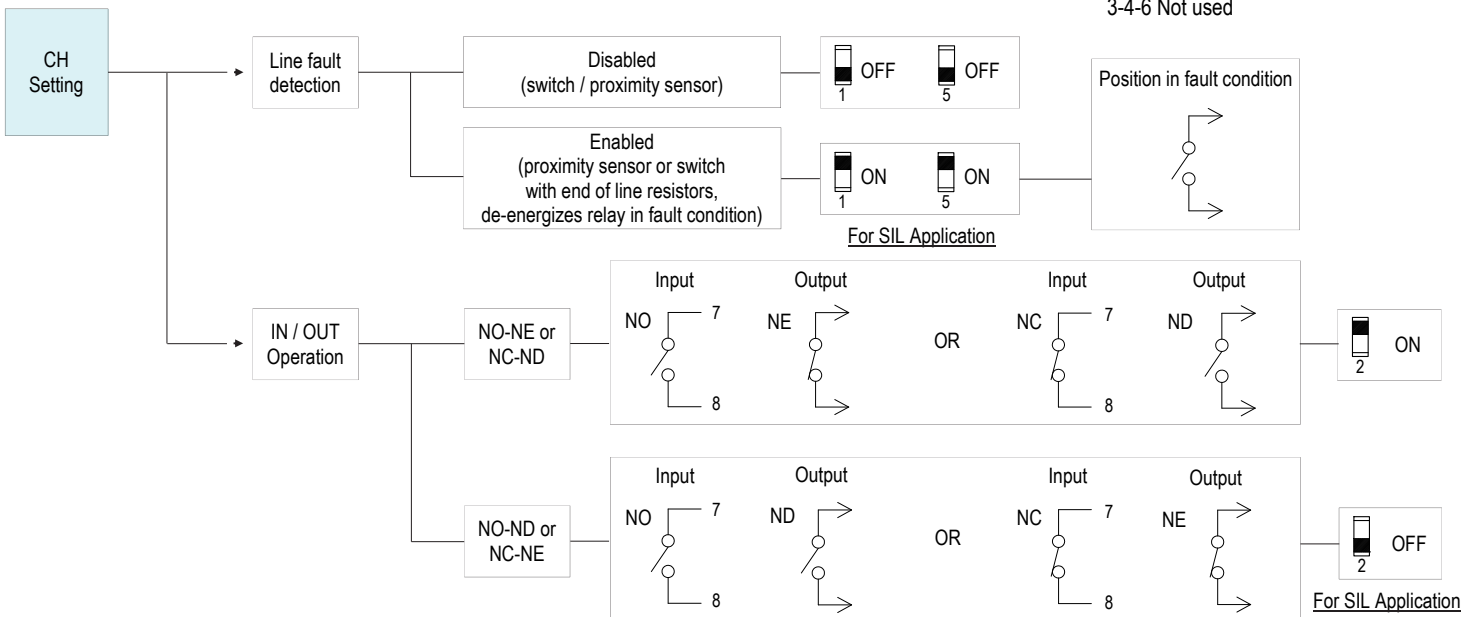

DIP Switch factory settings (valid for D5032S and D5032D)

| | | | | | | | |
|-----|-----|-----|-----|-----|-----|-----|-----|
| SW1 | SW2 | SW3 | SW4 | SW5 | SW6 | SW7 | SW8 |
| OFF | OFF | OFF | OFF | OFF | OFF | OFF | OFF |

D5032D (used as double channel) Configuration Summary Table

WARNING: dip-switch 6-7-8 must be set to “OFF” position.

| Channel | 1 | 2 | Channel | 1 | 2 |
|---|-----|-----|---------|-----|-----|
| Line fault detection | SW1 | SW5 | SW3 | SW2 | SW4 |
| Disabled (switch/proximity sensor) | OFF | OFF | OFF | ON | ON |
| Enabled, <u>for SIL application</u> (proximity sensor or switch with end of line resistors, detects field open circuit and short circuit, de-energizes relay in fault condition) | ON | ON | ON | OFF | OFF |

D5032D (used as duplicator or fault output) Configuration Summary Table

WARNING: Terminals 9-10 must be shorted to set module as Duplicator or Fault Out. Dip-switch 3 must be set to “OFF” position.

| Line fault detection | SW1 | SW5 | IN/OUT Operation Output 1 | SW2 |
|---|---|-----|---|-----|
| Disabled (switch/proximity sensor) | OFF | OFF | NO-NE or NC-ND | ON |
| Enabled, <u>for SIL application</u> (proximity sensor or switch with end of line resistors, detects field open circuit and short circuit, de-energizes relay in fault condition) | Output 1, (for SIL application) De-energized in Fault condition | ON | NO-ND or NC-NE (for SIL application) | OFF |
| | Output 1, Not specified Fault condition | OFF | | |

| Output 2 Operation | SW6 | SW7 | SW8 | Mode | SW4 | |
|--------------------|--|-----|-----|-----------------------------|-----------------------------------|---------------------|
| Duplicator | De-energized in fault condition (for SIL application) if line fault detection enabled (SW1 ON) | ON | OFF | ON | Parallel (for SIL application) | Set equal to SW2 |
| | Not specified Fault condition | OFF | | | Reverse | Set opposite to SW2 |
| Fault Output | OFF (for SIL application) | ON | OFF | ND | ON | |
| | | | | NE (for SIL application) | OFF | |

D5032S Configuration Summary Table

WARNING: Dip-switch 7-8 must be set to “OFF” position.

| Line fault detection | SW1 | SW5 | IN/OUT Operation | SW2 |
|---|-----|-----|---|-----|
| Disabled (switch/proximity sensor) | OFF | OFF | NO-NE or NC-ND | ON |
| Enabled, <u>for SIL application</u> (proximity sensor or switch with end of line resistors, detects field open circuit and short circuit, de-energizes relay in fault condition) | ON | ON | NO-ND or NC-NE (for SIL application) | OFF |