

Operating Instructions

Prosonic Flow E Heat

Ultrasonic time-of-flight flowmeter

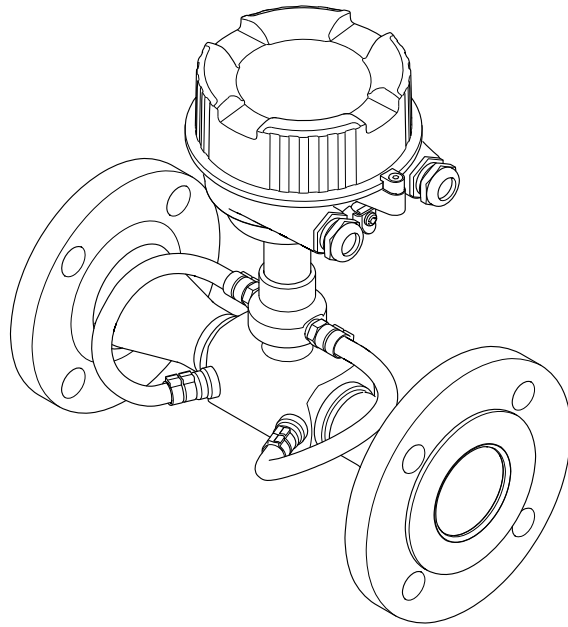

- Make sure the document is stored in a safe place such that it is always available when working on or with the device.
- To avoid danger to individuals or the facility, read the "Basic safety instructions" section carefully, as well as all other safety instructions in the document that are specific to working procedures.
- The manufacturer reserves the right to modify technical data without prior notice. Your Endress+Hauser Sales Center will supply you with current information and updates to these instructions.

Table of contents

1	About this document	5		
1.1	Document function	5		
1.2	Symbols used	5		
1.2.1	Safety symbols	5		
1.2.2	Electrical symbols	5		
1.2.3	Tool symbols	5		
1.2.4	Symbols for certain types of information	6		
1.2.5	Symbols in graphics	6		
1.3	Documentation	6		
1.3.1	Standard documentation	7		
1.3.2	Supplementary device-dependent documentation	7		
1.4	Registered trademarks	7		
2	Basic safety instructions	8		
2.1	Requirements for the personnel	8		
2.2	Designated use	8		
2.3	Workplace safety	9		
2.4	Operational safety	9		
2.5	Product safety	9		
2.6	IT security	10		
3	Product description	11		
3.1	Product design	11		
3.1.1	11		
4	Incoming acceptance and product identification	12		
4.1	Incoming acceptance	12		
4.2	Product identification	12		
4.2.1	Transmitter nameplate	13		
4.2.2	Sensor nameplate	14		
5	Storage and transport	15		
5.1	Storage conditions	15		
5.2	Transporting the product	15		
5.2.1	Measuring devices without lifting lugs	15		
5.2.2	Measuring devices with lifting lugs ..	16		
5.2.3	Transporting with a fork lift	16		
5.3	Packaging disposal	16		
6	Installation	16		
6.1	Installation conditions	16		
6.1.1	Mounting position	16		
6.1.2	Requirements from environment and process	18		
6.2	Mounting the measuring device	19		
6.2.1	Required tools	19		
6.2.2	Preparing the measuring device	19		
6.2.3	Mounting the measuring device	19		
6.3	Post-mounting check	20		
7	Electrical connection	21		
7.1	Connection conditions	21		
7.1.1	Required tools	21		
7.1.2	Requirements for connecting cable ...	21		
7.1.3	Terminal assignment	22		
7.1.4	Preparing the measuring device	23		
7.2	Connecting the measuring device	24		
7.2.1	Connecting the transmitter	24		
7.2.2	Ensuring potential equalization	25		
7.3	Special connection instructions	25		
7.3.1	Connection examples	25		
7.4	Ensuring the degree of protection	25		
7.5	Post-connection check	26		
8	Operation options	27		
8.1	Overview of operating options	27		
8.2	Access to the operating menu via the operating tool	27		
8.2.1	Connecting the operating tool	27		
8.2.2	DeviceCare	27		
9	System integration	29		
9.1	Overview of device description files	29		
9.1.1	Current version data for the device ...	29		
9.1.2	Operating tools	29		
10	Commissioning	30		
10.1	Function check	30		
10.2	Configuring the measuring device	30		
10.2.1	Defining the tag name	30		
10.2.2	Setting the system units	30		
10.2.3	Configuring the pulse/frequency output	32		
10.2.4	Configuring the low flow cut off	35		
10.3	Advanced settings	37		
10.3.1	Using the parameter to enter the access code	37		
10.3.2	Carrying out a sensor adjustment ...	37		
10.3.3	Configuring the totalizer	37		
10.3.4	Using parameters for device administration	38		
10.4	Simulation	39		
11	Operation	41		
11.1	Reading the device locking status	41		
11.2	Reading measured values	41		
11.2.1	Process variables	41		
11.2.2	System values	42		
11.2.3	"Totalizer" submenu	43		

11.3	Adapting the measuring device to the process conditions	43	16.2	Function and system design	60
11.4	Performing a totalizer reset	43	16.3	Input	60
11.4.1	Function scope of the "Control Totalizer" parameter	44	16.4	Output	61
11.4.2	Function scope of the "Reset all totalizers" parameter	44	16.5	Power supply	63
12	Diagnostics and troubleshooting	45	16.6	Performance characteristics	64
12.1	General troubleshooting	45	16.7	Installation	65
12.2	Diagnostic information via light emitting diodes	45	16.8	Environment	65
12.2.1	Transmitter	45	16.9	Process	66
12.3	Diagnostic information in FieldCare or DeviceCare	45	16.10	Mechanical construction	67
12.3.1	Diagnostic options	45	16.11	Operability	70
12.3.2	Calling up remedy information	46	16.12	Certificates and approvals	70
12.4	Adapting the diagnostic information	47	16.13	Application packages	71
12.4.1	Adapting the diagnostic behavior	47	16.14	Accessories	71
12.5	Overview of diagnostic information	47	16.15	Supplementary documentation	71
12.6	Pending diagnostic events	49	Index	73	
12.7	Diagnostic list	50			
12.8	Event logbook	50			
12.8.1	Reading out the event logbook	50			
12.8.2	Filtering the event logbook	51			
12.8.3	Overview of information events	51			
12.9	Resetting the measuring device	52			
12.9.1	Function scope of the "Device reset" parameter	52			
12.10	Device information	52			
12.11	Firmware history	54			
13	Maintenance	55			
13.1	Maintenance tasks	55			
13.1.1	Exterior cleaning	55			
13.2	Measuring and test equipment	55			
13.3	Endress+Hauser services	55			
14	Repairs	56			
14.1	General notes	56			
14.1.1	Repair and conversion concept	56			
14.1.2	Notes for repair and conversion	56			
14.2	Spare parts	56			
14.3	Endress+Hauser services	56			
14.4	Return	56			
14.5	Disposal	57			
14.5.1	Removing the measuring device	57			
14.5.2	Disposing of the measuring device	57			
15	Accessories	58			
15.1	Communication-specific accessories	58			
15.2	Service-specific accessories	58			
15.3	System components	59			
16	Technical data	60			
16.1	Application	60			





1 About this document

1.1 Document function





These Operating Instructions contain all the information that is required in various phases of the life cycle of the device: from product identification, incoming acceptance and storage, to mounting, connection, operation and commissioning through to troubleshooting, maintenance and disposal.

1.2 Symbols used



1.2.1 Safety symbols

Symbol	Meaning
	DANGER! This symbol alerts you to a dangerous situation. Failure to avoid this situation will result in serious or fatal injury.
	WARNING! This symbol alerts you to a dangerous situation. Failure to avoid this situation can result in serious or fatal injury.
	CAUTION! This symbol alerts you to a dangerous situation. Failure to avoid this situation can result in minor or medium injury.
	NOTE! This symbol contains information on procedures and other facts which do not result in personal injury.













1.2.2 Electrical symbols

Symbol	Meaning
	Direct current
	Alternating current
	Direct current and alternating current
	Ground connection A grounded terminal which, as far as the operator is concerned, is grounded via a grounding system.
	Protective Earth (PE) A terminal which must be connected to ground prior to establishing any other connections. The ground terminals are situated inside and outside the device: <ul style="list-style-type: none"> ▪ Inner ground terminal: Connects the protective earth to the mains supply. ▪ Outer ground terminal: Connects the device to the plant grounding system.





1.2.3 Tool symbols

Symbol	Meaning
	Allen key
	Open-ended wrench

1.2.4 Symbols for certain types of information

Symbol	Meaning
	Permitted Procedures, processes or actions that are permitted.
	Preferred Procedures, processes or actions that are preferred.
	Forbidden Procedures, processes or actions that are forbidden.
	Tip Indicates additional information.
	Reference to documentation.
	Reference to page.
	Reference to graphic.
	Notice or individual step to be observed.
	Series of steps.
	Result of a step.
	Help in the event of a problem.
	Visual inspection.



1.2.5 Symbols in graphics

Symbol	Meaning
1, 2, 3, ...	Item numbers
	Series of steps
A, B, C, ...	Views
A-A, B-B, C-C, ...	Sections
	Hazardous area
	Safe area (non-hazardous area)
	Flow direction

1.3 Documentation

 For an overview of the scope of the associated Technical Documentation, refer to the following:

- The *W@M Device Viewer* : Enter the serial number from the nameplate (www.endress.com/deviceviewer)
- The *Endress+Hauser Operations App*: Enter the serial number from the nameplate or scan the 2-D matrix code (QR code) on the nameplate.

 For a detailed list of the individual documents along with the documentation code
→  71

1.3.1 Standard documentation

Document type	Purpose and content of the document
Technical Information	<p>Planning aid for your device</p> <p>The document contains all the technical data on the device and provides an overview of the accessories and other products that can be ordered for the device.</p>
Sensor Brief Operating Instructions	<p>Guides you quickly to the 1st measured value - Part 1</p> <p>The Sensor Brief Operating Instructions are aimed at specialists with responsibility for installing the measuring device.</p> <ul style="list-style-type: none"> ▪ Incoming acceptance and product identification ▪ Storage and transport ▪ Installation
Transmitter Brief Operating Instructions	<p>Guides you quickly to the 1st measured value - Part 2</p> <p>The Transmitter Brief Operating Instructions are aimed at specialists with responsibility for commissioning, configuring and parameterizing the measuring device (until the first measured value).</p> <ul style="list-style-type: none"> ▪ Product description ▪ Installation ▪ Electrical connection ▪ Operation options ▪ System integration ▪ Commissioning ▪ Diagnostic information
Description of Device Parameters	<p>Reference for your parameters</p> <p>The document provides a detailed explanation of each individual parameter in the Expert operating menu. The description is aimed at those who work with the device over the entire life cycle and perform specific configurations.</p>

1.3.2 Supplementary device-dependent documentation

Additional documents are supplied depending on the device version ordered: Always comply strictly with the instructions in the supplementary documentation. The supplementary documentation is an integral part of the device documentation.

1.4 Registered trademarks

Microsoft®

Registered trademark of the Microsoft Corporation, Redmond, Washington, USA

2 Basic safety instructions

2.1 Requirements for the personnel

The personnel for installation, commissioning, diagnostics and maintenance must fulfill the following requirements:

- ▶ Trained, qualified specialists must have a relevant qualification for this specific function and task.
- ▶ Are authorized by the plant owner/operator.
- ▶ Are familiar with federal/national regulations.
- ▶ Before starting work, read and understand the instructions in the manual and supplementary documentation as well as the certificates (depending on the application).
- ▶ Follow instructions and comply with basic conditions.

The operating personnel must fulfill the following requirements:

- ▶ Are instructed and authorized according to the requirements of the task by the facility's owner-operator.
- ▶ Follow the instructions in this manual.

2.2 Designated use

Application and media

Depending on the version ordered, the measuring device can also measure potentially explosive, flammable, poisonous and oxidizing media.

Measuring devices for use in hazardous areas, in hygienic applications or where there is an increased risk due to process pressure, are labeled accordingly on the nameplate.

To ensure that the measuring device remains in proper condition for the operation time:

- ▶ Keep within the specified pressure and temperature range.
- ▶ Only use the measuring device in full compliance with the data on the nameplate and the general conditions listed in the Operating Instructions and supplementary documentation.
- ▶ Based on the nameplate, check whether the ordered device is permitted for the intended use in the hazardous area (e.g. explosion protection, pressure vessel safety).
- ▶ Use the measuring device only for media to which the process-wetted materials are sufficiently resistant.
- ▶ If the measuring device is not operated at atmospheric temperature, compliance with the relevant basic conditions specified in the associated device documentation is absolutely essential: "Documentation" section →  6.
- ▶ Protect the measuring device permanently against corrosion from environmental influences.

Incorrect use

Non-designated use can compromise safety. The manufacturer is not liable for damage caused by improper or non-designated use.

WARNING

Danger of breakage due to corrosive or abrasive fluids!

- ▶ Verify the compatibility of the process fluid with the sensor material.
- ▶ Ensure the resistance of all fluid-wetted materials in the process.
- ▶ Keep within the specified pressure and temperature range.

NOTICE**Verification for borderline cases:**

- ▶ For special fluids and fluids for cleaning, Endress+Hauser is glad to provide assistance in verifying the corrosion resistance of fluid-wetted materials, but does not accept any warranty or liability as minute changes in the temperature, concentration or level of contamination in the process can alter the corrosion resistance properties.

Residual risks**⚠ WARNING****The electronics and the medium may cause the surfaces to heat up. This presents a burn hazard!**

- ▶ For elevated fluid temperatures, ensure protection against contact to prevent burns.

2.3 Workplace safety

For work on and with the device:

- ▶ Wear the required personal protective equipment according to federal/national regulations.

For welding work on the piping:

- ▶ Do not ground the welding unit via the measuring device.

If working on and with the device with wet hands:

- ▶ Due to the increased risk of electric shock, gloves must be worn.

2.4 Operational safety

Risk of injury.

- ▶ Operate the device in proper technical condition and fail-safe condition only.
- ▶ The operator is responsible for interference-free operation of the device.

Conversions to the device

Unauthorized modifications to the device are not permitted and can lead to unforeseeable dangers.

- ▶ If, despite this, modifications are required, consult with Endress+Hauser.

Repair

To ensure continued operational safety and reliability,

- ▶ Carry out repairs on the device only if they are expressly permitted.
- ▶ Observe federal/national regulations pertaining to repair of an electrical device.
- ▶ Use original spare parts and accessories from Endress+Hauser only.

2.5 Product safety

This measuring device is designed in accordance with good engineering practice to meet state-of-the-art safety requirements, has been tested, and left the factory in a condition in which it is safe to operate.

It meets general safety standards and legal requirements. It also complies with the EU directives listed in the device-specific EU Declaration of Conformity. Endress+Hauser confirms this by affixing the CE mark to the device.

2.6 IT security

We only provide a warranty if the device is installed and used as described in the Operating Instructions. The device is equipped with security mechanisms to protect it against any inadvertent changes to the device settings.

IT security measures in line with operators' security standards and designed to provide additional protection for the device and device data transfer must be implemented by the operators themselves.

3 Product description

The device consists of a transmitter and a sensor.

The device is available as a compact version:

The transmitter and sensor form a mechanical unit.

3.1 Product design

3.1.1

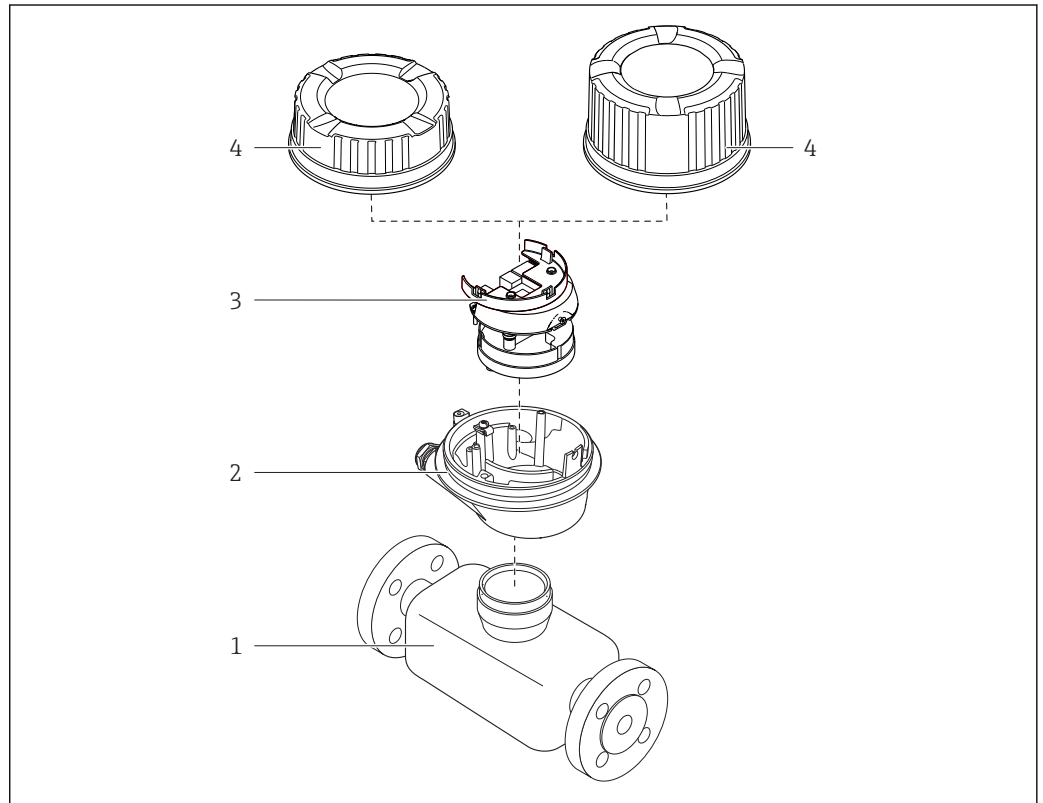

A0035038

1 Important components of a measuring device

- 1 Sensor
- 2 Transmitter housing
- 3 Main electronics module
- 4 Transmitter housing cover

4 Incoming acceptance and product identification

4.1 Incoming acceptance



A0028673

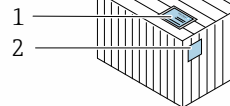
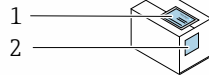

Are the order codes on the delivery note (1) and the product sticker (2) identical?

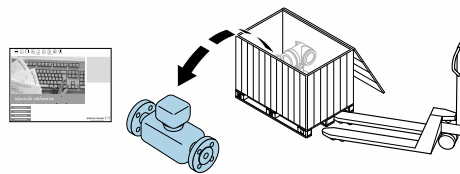

A0028673

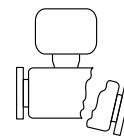
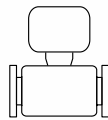

Are the goods undamaged?



A0028673

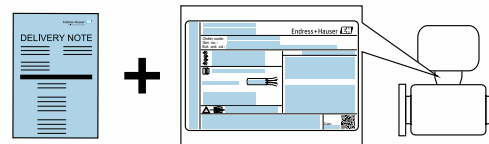

Do the nameplate data match the ordering information on the delivery note?



A0028673

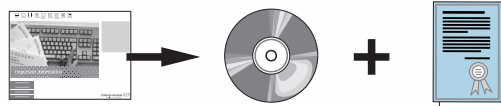

Is the CD-ROM with the Technical Documentation (depends on device version) and documents present?



- i** ■ If one of the conditions is not satisfied, contact your Endress+Hauser Sales Center.
- Depending on the device version, the CD-ROM might not be part of the delivery! The Technical Documentation is available via the Internet or via the *Endress+Hauser Operations App*, see the "Product identification" section → 13.

4.2 Product identification

The following options are available for identification of the measuring device:

- Nameplate specifications
- Order code with breakdown of the device features on the delivery note
- Enter serial numbers from nameplates in *W@M Device Viewer* (www.endress.com/deviceviewer): All information about the measuring device is displayed.
- Enter the serial number from the nameplates into the *Endress+Hauser Operations App* or scan the 2-D matrix code (QR code) on the nameplate with the *Endress+Hauser Operations App*: all the information for the measuring device is displayed.

For an overview of the scope of the associated Technical Documentation, refer to the following:

- The chapters "Additional standard documentation on the device" →  7 and "Supplementary device-dependent documentation" →  7
- The *W@M Device Viewer*: Enter the serial number from the nameplate (www.endress.com/deviceviewer)
- The *Endress+Hauser Operations App*: Enter the serial number from the nameplate or scan the 2-D matrix code (QR code) on the nameplate.

4.2.1 Transmitter nameplate

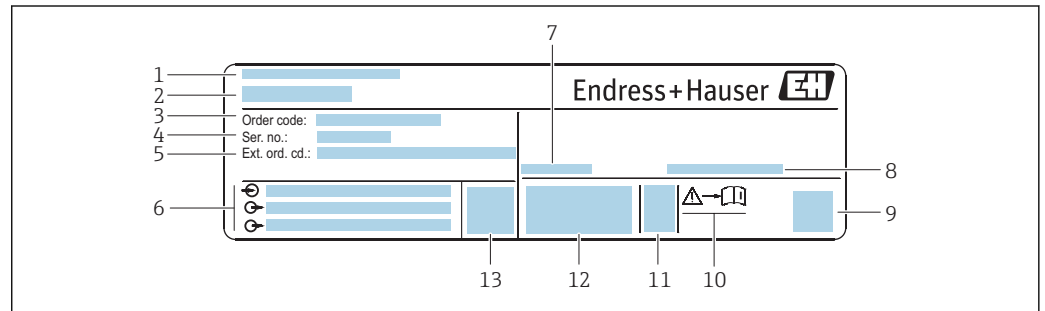

A0030222

 2 Example of a transmitter nameplate

- 1 Manufacturing location
- 2 Name of the transmitter
- 3 Order code
- 4 Serial number (ser. no.)
- 5 Extended order code (Ext. ord. cd.)
- 6 Electrical connection data, e.g. available inputs and outputs, supply voltage
- 7 Permitted ambient temperature (T_a)
- 8 Degree of protection
- 9 2-D matrix code
- 10 Document number of safety-related supplementary documentation
- 11 Manufacturing date: year-month
- 12 CE mark, C-Tick
- 13 Firmware version (FW)

4.2.2 Sensor nameplate

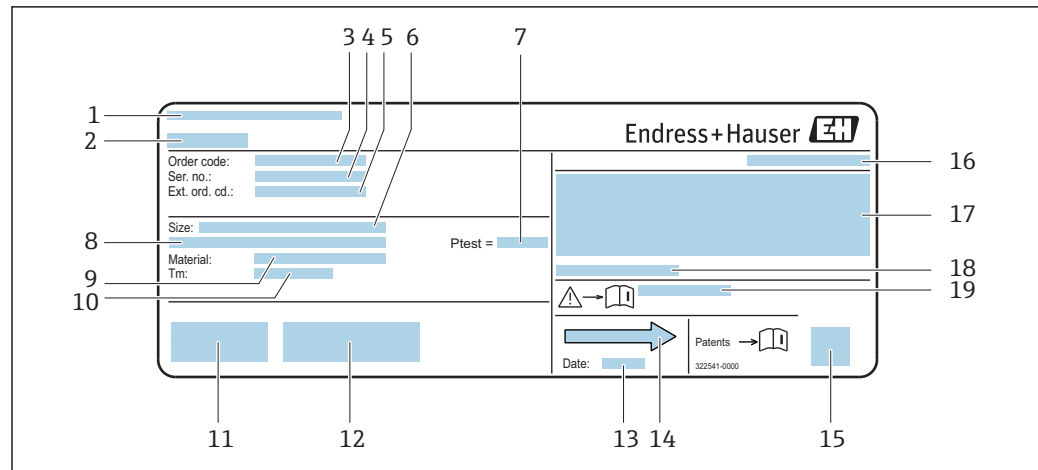

A0013907

 3 Example of a sensor nameplate

- 1 Manufacturing location
- 2 Name of the sensor
- 3 Order code
- 4 Serial number (ser. no.)
- 5 Extended order code (Ext. ord. cd.)
- 6 Nominal diameter of sensor
- 7 Test pressure of the sensor
- 8 Flange nominal diameter/nominal pressure
- 9 Material of measuring tube and manifold
- 10 Medium temperature range
- 11 CE mark, C-Tick
- 12 Additional information on version: certificates, approvals
- 13 Manufacturing date: year-month
- 14 Flow direction
- 15 2-D matrix code
- 16 Degree of protection
- 17 Approval information for explosion protection and Pressure Equipment Directive
- 18 Permitted ambient temperature (T_a)
- 19 Document number of safety-related supplementary documentation

Order code

The measuring device is reordered using the order code.

Extended order code

- The device type (product root) and basic specifications (mandatory features) are always listed.
- Of the optional specifications (optional features), only the safety and approval-related specifications are listed (e.g. LA). If other optional specifications are also ordered, these are indicated collectively using the # placeholder symbol (e.g. #LA#).
- If the ordered optional specifications do not include any safety and approval-related specifications, they are indicated by the + placeholder symbol (e.g. XXXXXX-ABCDE +).

5 Storage and transport

5.1 Storage conditions

Observe the following notes for storage:

- ▶ Store in the original packaging to ensure protection from shock.
- ▶ Do not remove protective covers or protective caps installed on process connections. They prevent mechanical damage to the sealing surfaces and contamination in the measuring tube.
- ▶ Protect from direct sunlight to avoid unacceptably high surface temperatures.
- ▶ Store in a dry and dust-free place.
- ▶ Do not store outdoors.

Storage temperature → 📄 65

5.2 Transporting the product

Transport the measuring device to the measuring point in the original packaging.

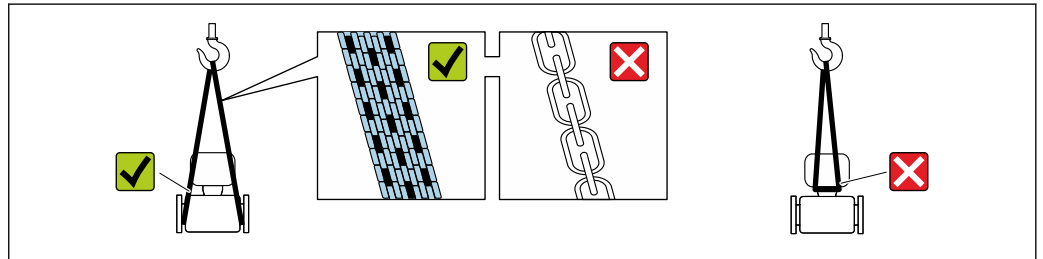

A0029252

- i** Do not remove protective covers or caps installed on process connections. They prevent mechanical damage to the sealing surfaces and contamination in the measuring tube.

5.2.1 Measuring devices without lifting lugs

⚠ WARNING

Center of gravity of the measuring device is higher than the suspension points of the webbing slings.

Risk of injury if the measuring device slips.

- ▶ Secure the measuring device against slipping or turning.
- ▶ Observe the weight specified on the packaging (stick-on label).

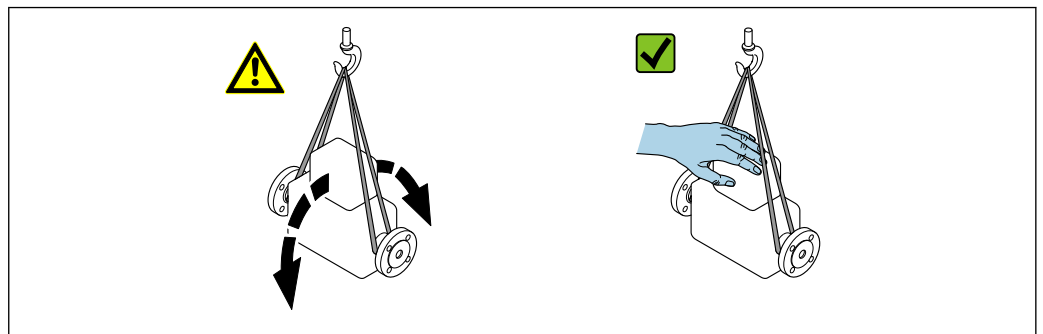

A0029214

5.2.2 Measuring devices with lifting lugs

⚠ CAUTION

Special transportation instructions for devices with lifting lugs

- ▶ Only use the lifting lugs fitted on the device or flanges to transport the device.
- ▶ The device must always be secured at two lifting lugs at least.

5.2.3 Transporting with a fork lift

If transporting in wood crates, the floor structure enables the crates to be lifted lengthwise or at both sides using a forklift.

5.3 Packaging disposal

All packaging materials are environmentally friendly and 100% recyclable:

- Measuring device secondary packaging: polymer stretch film that conforms to EC Directive 2002/95/EC (RoHS).
- Packaging:
 - Wood crate, treated in accordance with ISPM 15 standard, which is confirmed by the affixed IPPC logo.
 - or
 - Carton in accordance with European Packaging Directive 94/62EC; recyclability is confirmed by the affixed RESY symbol.
- Seaworthy packaging (optional): Wood crate, treated in accordance with ISPM 15 standard, which is confirmed by the affixed IPPC logo.
- Carrying and mounting hardware:
 - Disposable plastic pallet
 - Plastic straps
 - Plastic adhesive strips
- Dunnage: Paper cushion

6 Installation

6.1 Installation conditions

No special measures such as supports etc. are necessary. External forces are absorbed by the construction of the device.

6.1.1 Mounting position

Mounting location

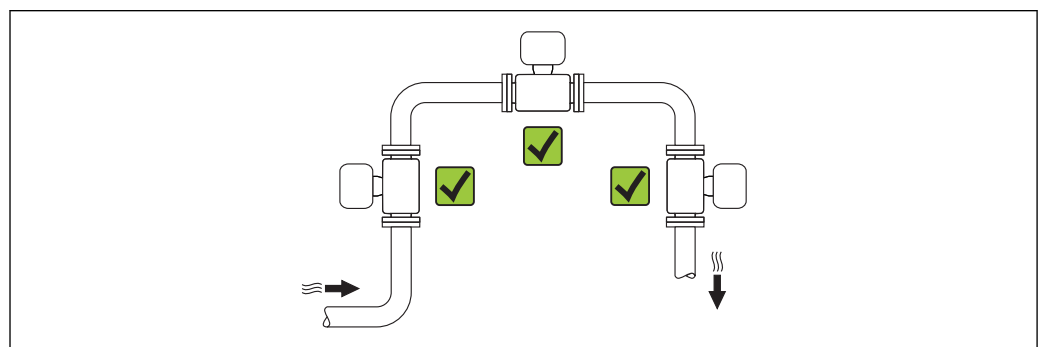

A0015543



Orientation

The direction of the arrow on the nameplate helps you to install the sensor according to the flow direction (direction of medium flow through the piping).

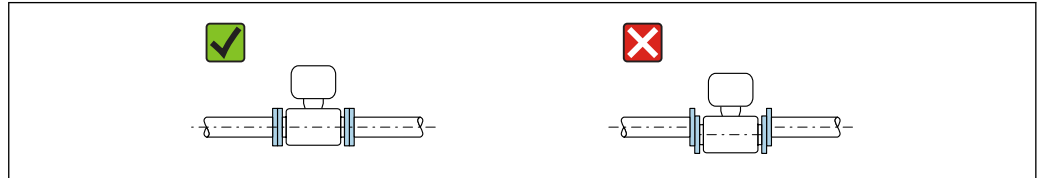
-  ■ Install the measuring device in a parallel plane free of external mechanical stress.
- The internal diameter of the pipe must match the internal diameter of the sensor: see the "Technical Information" device document, "Design and dimensions" section.

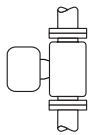
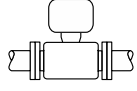
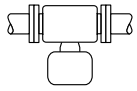

A0015895

Orientation		Compact version
A	Vertical orientation	 A0015545 ✓✓
B	Horizontal orientation, transmitter head up	 A0015589 ✓✓
C	Horizontal orientation, transmitter head down	 A0015590 ✓
D	Horizontal orientation, transmitter head at side	 A0015592 ✗

Inlet and outlet runs

If possible, the sensor should be installed upstream from valves, T-pieces, elbows etc. To attain the specified level of accuracy of the measuring device, the below mentioned inlet and outlet runs must be maintained at minimum. If there are several flow disturbances present, the longest specified inlet run must be maintained.

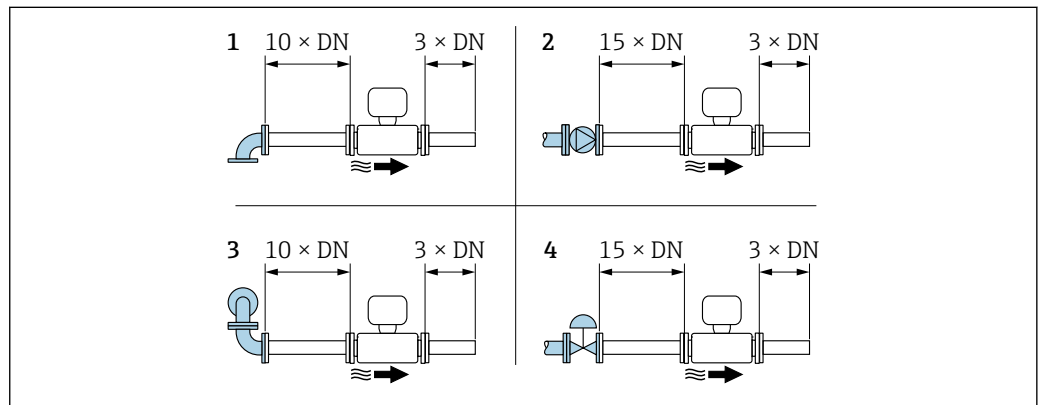

A0033877

 4 Minimum inlet and outlet runs with various flow obstructions

- 1 90 ° elbow or T-section
- 2 Pump
- 3 2 × 90 ° elbow, 3-dimensional
- 4 Control valve

Outlet runs when installing external devices

If installing an external device, observe the specified distance.

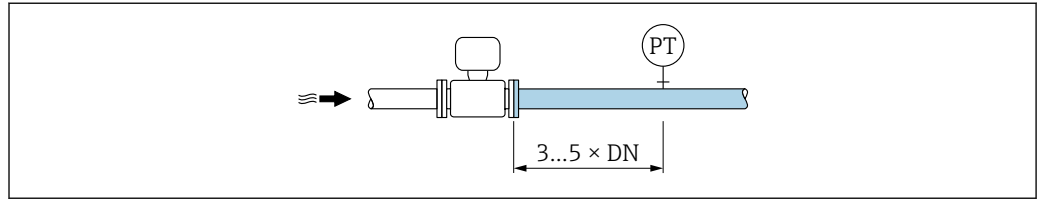

A0015901

PT Pressure

Installation dimensions



For the dimensions and installation lengths of the device, see the "Technical Information" document, "Mechanical construction" section.

6.1.2 Requirements from environment and process

Ambient temperature range

Transmitter	-25 to +55 °C (-13 to +131 °F) as per EN 1434 environmental class B
Sensor	-25 to +55 °C (-13 to +131 °F) as per EN 1434 environmental class B

- ▶ If operating outdoors:
Avoid direct sunlight, particularly in warm climatic regions.

System pressure

It is important that cavitation does not occur, or that gases entrained in the liquids do not outgas.

Cavitation is caused if the pressure drops below the vapor pressure:
In suction lines

- ▶ Ensure the system pressure is sufficiently high to prevent cavitation and outgassing.

For this reason, the following mounting locations are recommended:

- At the lowest point in a vertical pipe
- Downstream from pumps (no danger of vacuum)

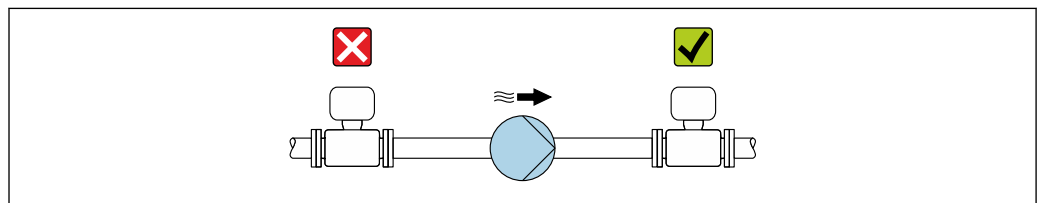

A0028777

Thermal insulation

In the case of some fluids, it is important to keep the heat radiated from the sensor to the transmitter to a low level. A wide range of materials can be used for the required insulation.

NOTICE**Electronics overheating on account of thermal insulation!**

- ▶ Observe maximum permitted insulation height of the transmitter neck so that the transmitter head is completely free.

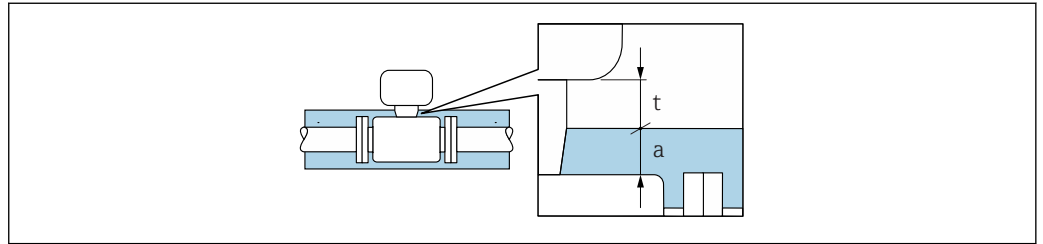

A0034104

- t* Maximum insulation thickness 2 cm (0.79 in)
a Minimum distance from transmitter to insulation

6.2 Mounting the measuring device

6.2.1 Required tools

For sensor

For flanges and other process connections: Corresponding mounting tools

6.2.2 Preparing the measuring device

1. Remove all remaining transport packaging.
2. Remove any protective covers or protective caps present from the sensor.
3. Remove stick-on label on the electronics compartment cover.

6.2.3 Mounting the measuring device

⚠ WARNING

Danger due to improper process sealing!

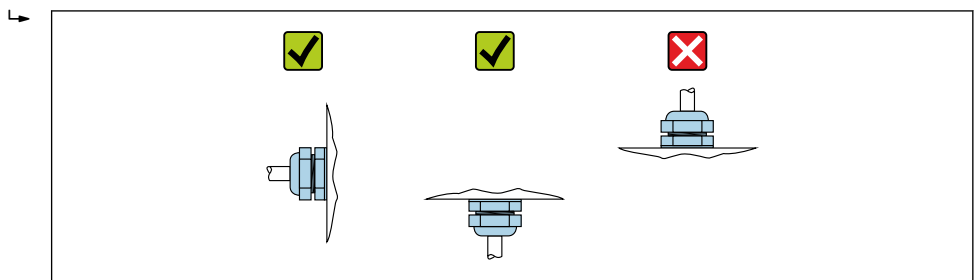

- ▶ Ensure that the inside diameters of the gaskets are greater than or equal to that of the process connections and piping.
- ▶ Ensure that the gaskets are clean and undamaged.
- ▶ Install the gaskets correctly.

1. Ensure that the direction of the arrow on the sensor matches the flow direction of the medium.
2. Install the measuring device or turn the transmitter housing so that the cable entries do not point upwards.



A0029263

6.3 Post-mounting check

Is the device undamaged (visual inspection)?	<input type="checkbox"/>
Does the measuring device conform to the measuring point specifications? For example: <ul style="list-style-type: none"> ▪ Process temperature ▪ Process pressure (refer to the section on "Pressure-temperature ratings" in the "Technical Information" document) ▪ Ambient temperature range ▪ Measuring range 	<input type="checkbox"/>
Has the correct orientation for the sensor been selected →  17? <ul style="list-style-type: none"> ▪ According to sensor type ▪ According to medium temperature ▪ According to medium properties (outgassing, with entrained solids) 	<input type="checkbox"/>
Does the arrow on the sensor match the direction of flow of the medium through the piping →  17?	<input type="checkbox"/>
Are the measuring point identification and labeling correct (visual inspection)?	<input type="checkbox"/>
Is the device adequately protected from precipitation and direct sunlight?	<input type="checkbox"/>
Are the securing screw and securing clamp tightened securely?	<input type="checkbox"/>

7 Electrical connection

NOTICE

The measuring device does not have an internal circuit breaker.

- ▶ For this reason, assign the measuring device a switch or power-circuit breaker so that the power supply line can be easily disconnected from the mains.
- ▶ Although the measuring device is equipped with a fuse, additional overcurrent protection (maximum 16 A) should be integrated into the system installation.

7.1 Connection conditions

7.1.1 Required tools

- For cable entries: Use corresponding tools
- For securing clamp (on aluminum housing): Allen screw 3 mm
- For securing screw (for stainless steel housing): open-ended wrench 8 mm
- Wire stripper
- When using stranded cables: crimper for wire end ferrule

7.1.2 Requirements for connecting cable

The connecting cables provided by the customer must fulfill the following requirements.

Electrical safety

In accordance with applicable federal/national regulations.

Permitted temperature range

- The installation guidelines that apply in the country of installation must be observed.
- The cables must be suitable for the minimum and maximum temperatures to be expected.

Power supply cable

Standard installation cable is sufficient.

Signal cable

Pulse/frequency output

Standard installation cable is sufficient.

Cable diameter

- Cable glands supplied:
M20 × 1.5 with cable \varnothing 6 to 12 mm (0.24 to 0.47 in)
- Spring terminals:
Wire cross-sections 0.5 to 2.5 mm² (20 to 14 AWG)

7.1.3 Terminal assignment

Transmitter

Pulse output connection version

Order code for "Output", option **P**

Order code for "Housing"	Connection methods available		Possible selection order code for "Electrical connection"
	Outputs	Power supply	
Option A	Terminals	Terminals	<ul style="list-style-type: none"> ■ Option A: coupling M20x1 ■ Option B: thread M20x1 ■ Option C: thread G ½" ■ Option D: thread NPT ½"
Option B	Terminals	Terminals	<ul style="list-style-type: none"> ■ Option A: coupling M20x1 ■ Option B: thread M20x1 ■ Option C: thread G ½" ■ Option D: thread NPT ½"
Order code for "Housing": <ul style="list-style-type: none"> ■ Option A: Compact, aluminum, coated ■ Option B: Compact, aluminum, coated + window 			

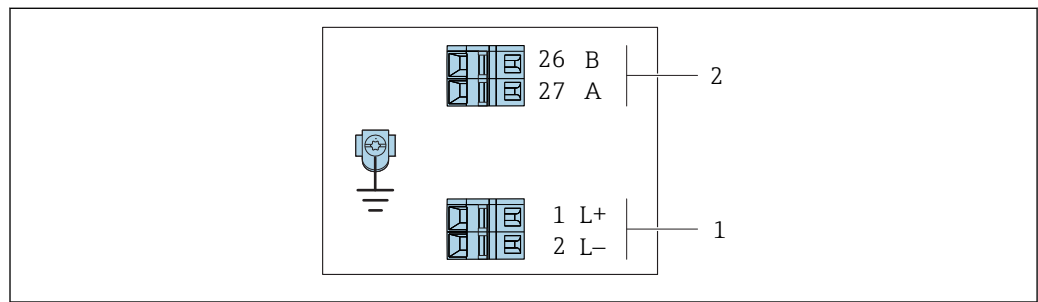

A0019528

5 Pulse output terminal assignment

- 1 Power supply: DC 24 V
- 2 Pulse output

Order code for "Output"	Terminal number			
	Power supply		Output	
	1 (L+)	2 (L-)	26 (B)	27 (A)
Option P	DC 24 V		Pulse output	
Order code for "Output", option P : Pulse output				

Pulse/frequency output connection version

Order code for "Output", option **K**

Order code for "Housing"	Connection methods available		Possible selection order code for "Electrical connection"
	Outputs	Power supply	
Option A	Terminals	Terminals	<ul style="list-style-type: none"> ▪ Option A: coupling M20x1 ▪ Option B: thread M20x1 ▪ Option C: thread G ½" ▪ Option D: thread NPT ½"
Option B	Terminals	Terminals	<ul style="list-style-type: none"> ▪ Option A: coupling M20x1 ▪ Option B: thread M20x1 ▪ Option C: thread G ½" ▪ Option D: thread NPT ½"
Order code for "Housing": <ul style="list-style-type: none"> ▪ Option A: Compact, aluminum, coated ▪ Option B: Compact, aluminum, coated + window 			

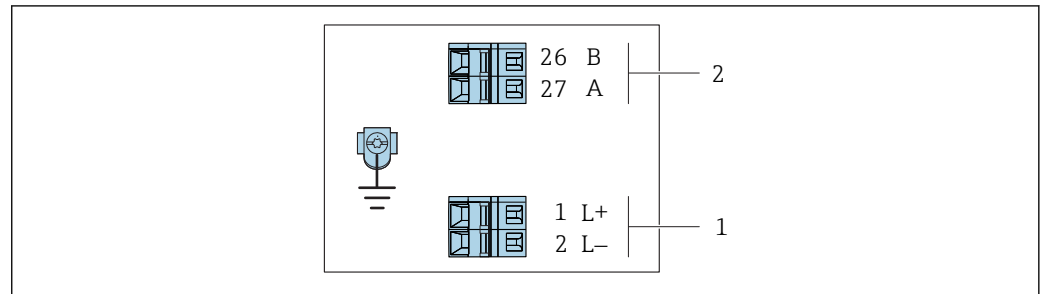

A0019528

6 Pulse/frequency output terminal assignment

- 1 Power supply: DC 24 V
- 2 Pulse/frequency output

Order code for "Output"	Terminal number			
	Power supply		Output	
	1 (L+)	2 (L-)	26 (B)	27 (A)
Option K	DC 24 V		Pulse/frequency output	
Order code for "Output", option K : Pulse/frequency output				

7.1.4 Preparing the measuring device

NOTICE

Insufficient sealing of the housing!

Operational reliability of the measuring device could be compromised.

► Use suitable cable glands corresponding to the degree of protection.

1. Remove dummy plug if present.
2. If the measuring device is supplied without cable glands:
Provide suitable cable gland for corresponding connecting cable.
3. If the measuring device is supplied with cable glands:
Observe requirements for connecting cables → 21.

7.2 Connecting the measuring device

NOTICE

Limitation of electrical safety due to incorrect connection!

- ▶ Have electrical connection work carried out by appropriately trained specialists only.
- ▶ Observe applicable federal/national installation codes and regulations.
- ▶ Comply with local workplace safety regulations.

7.2.1 Connecting the transmitter

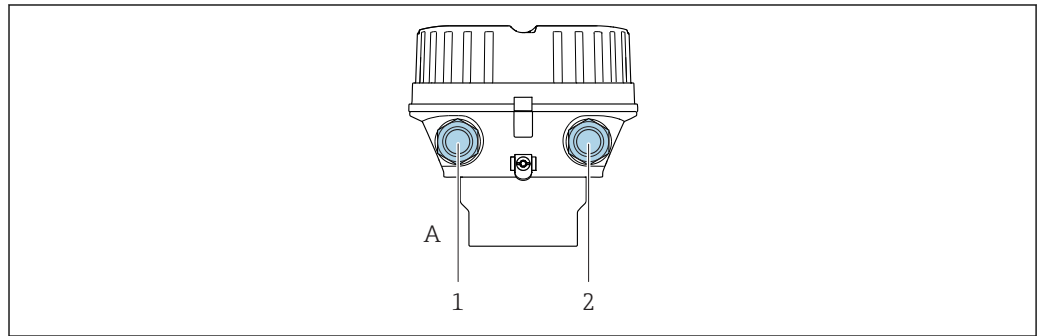

A0090221

- A Housing version: compact, aluminum coated
 1 Cable entry for signal transmission
 2 Cable entry for supply voltage

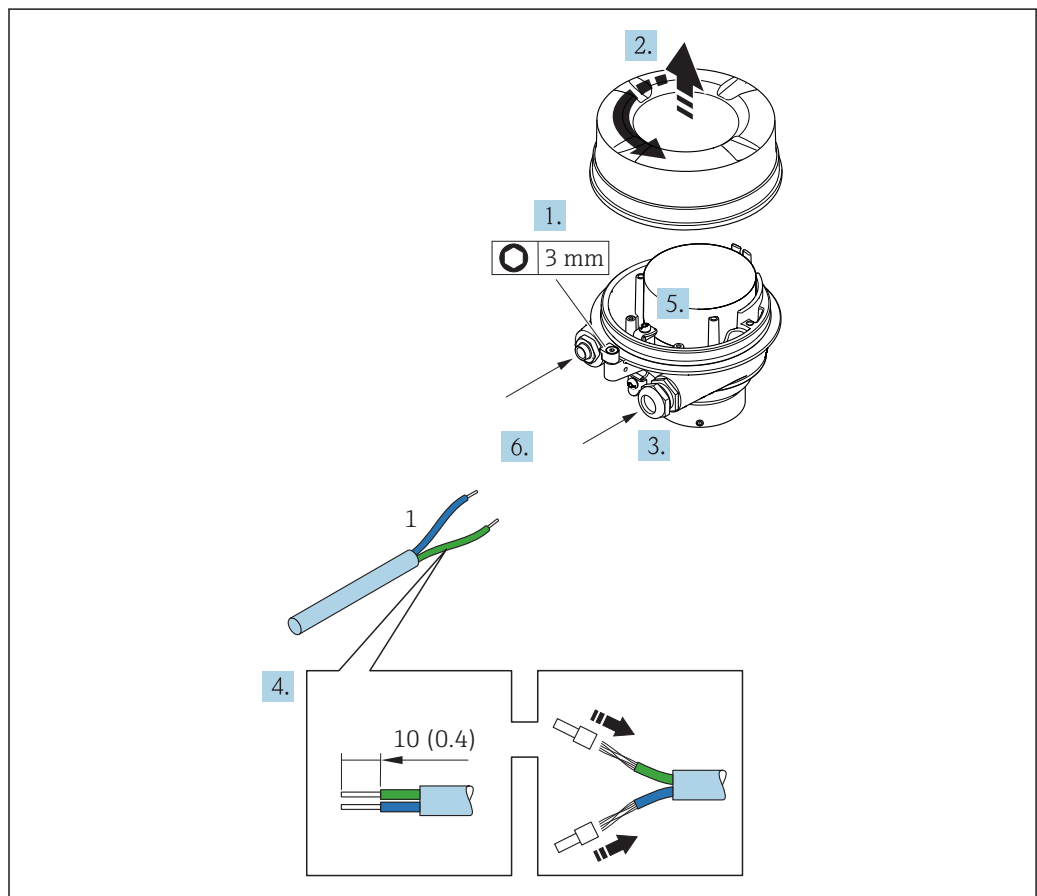

A0090223

- 7 Device versions with connection example. Engineering unit mm (in)

- 1 Cable

1. Loosen the securing clamp of the housing cover.

2. Unscrew the housing cover.
3. Push the cable through the cable entry. To ensure tight sealing, do not remove the sealing ring from the cable entry.
4. Strip the cable and cable ends. In the case of stranded cables, also fit ferrules.
5. Connect the cable in accordance with the terminal assignment .
6. Firmly tighten cable glands .
7. **⚠ WARNING**
Housing degree of protection may be voided due to insufficient sealing of the housing.
 - ▶ Screw in the screw without using any lubricant. The threads on the cover are coated with a dry lubricant.

Reverse the removal procedure to reassemble the transmitter.

7.2.2 Ensuring potential equalization

Requirements

Company-internal grounding concepts

7.3 Special connection instructions

7.3.1 Connection examples

Pulse/frequency output

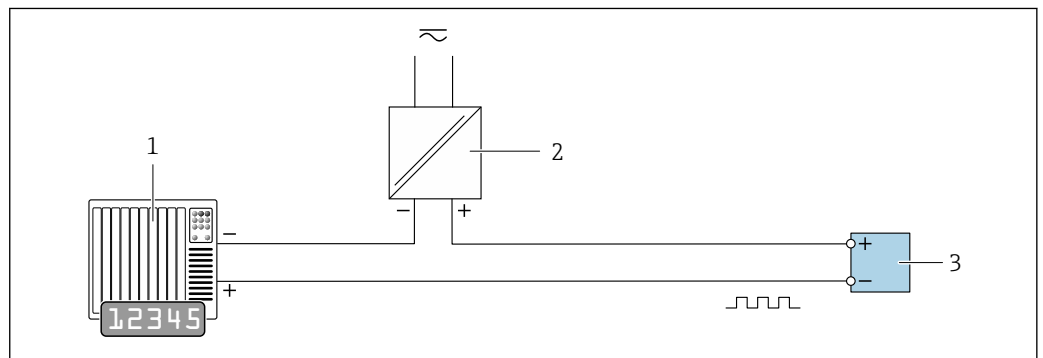

8 Connection example for pulse/frequency output (passive)

- 1 Automation system with pulse/frequency input (e.g. PLC)
- 2 Power supply
- 3 Transmitter: Observe input values

7.4 Ensuring the degree of protection

The measuring device fulfills all the requirements for the IP66/67 degree of protection, Type 4X enclosure.

To guarantee IP66/67 degree of protection, Type 4X enclosure, carry out the following steps after the electrical connection:

1. Check that the housing seals are clean and fitted correctly.
2. Dry, clean or replace the seals if necessary.
3. Tighten all housing screws and screw covers.

4. Firmly tighten the cable glands.
5. To ensure that moisture does not enter the cable entry:
Route the cable so that it loops down before the cable entry ("water trap").

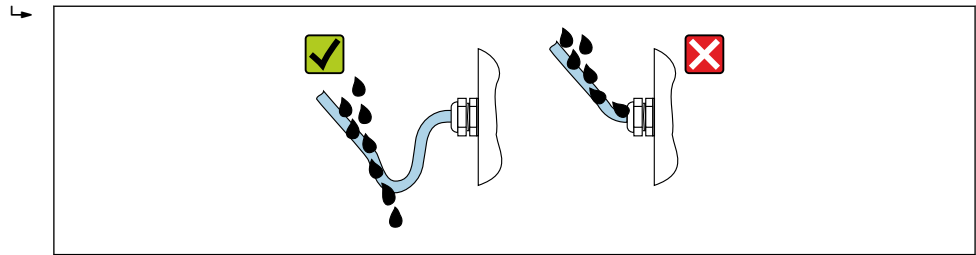

A0029278

6. Insert dummy plugs into unused cable entries.

7.5 Post-connection check

Are cables or the device undamaged (visual inspection)?	<input type="checkbox"/>
Do the cables used meet the requirements → 21?	<input type="checkbox"/>
Do the cables have adequate strain relief?	<input type="checkbox"/>
Are all the cable glands installed, firmly tightened and leak-tight? Cable run with "water trap" → 25?	<input type="checkbox"/>
Does the supply voltage match the specifications on the transmitter nameplate → 63?	<input type="checkbox"/>
If supply voltage is present, is the power LED on the electronics module of the transmitter lit green → 11?	<input type="checkbox"/>
Depending on the device version, is the securing clamp or fixing screw firmly tightened?	<input type="checkbox"/>

8 Operation options

8.1 Overview of operating options

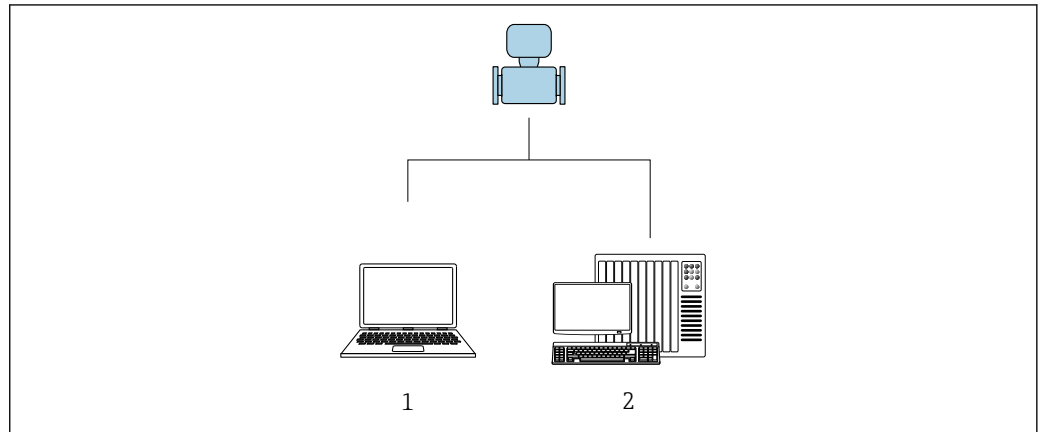

- 1 Computer with "FieldCare" or "DeviceCare" operating tool via Commubox FXA291 and service interface
 2 Automation system

8.2 Access to the operating menu via the operating tool

8.2.1 Connecting the operating tool

Via service interface (CDI)

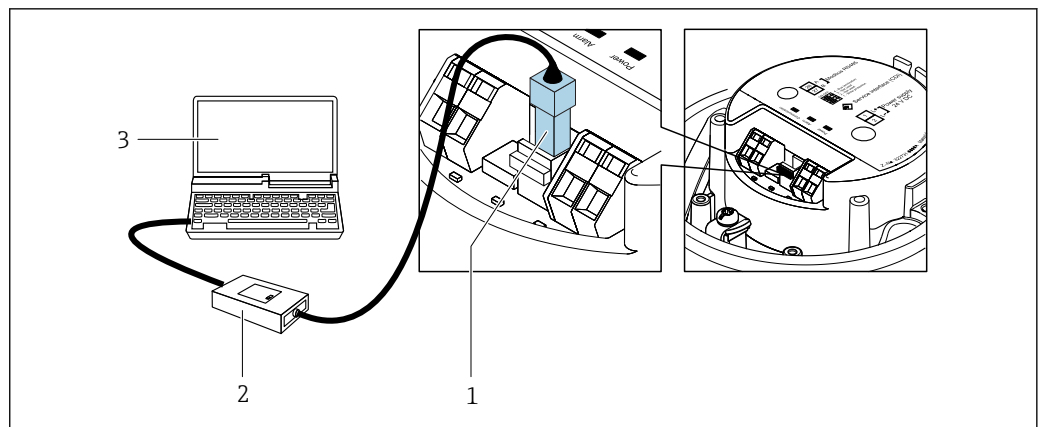

- 1 Service interface (CDI = Common Data Interface) of the measuring device
 2 Commubox FXA291
 3 Computer with "FieldCare" operating tool with "CDI Communication FXA291" COM DTM

8.2.2 DeviceCare

Function scope

Tool to connect and configure Endress+Hauser field devices.

The fastest way to configure Endress+Hauser field devices is with the dedicated "DeviceCare" tool. Together with the device type managers (DTMs) it presents a convenient, comprehensive solution.



For details, see Innovation Brochure IN01047S



Source for device description files

See information →  29

9 System integration

9.1 Overview of device description files

9.1.1 Current version data for the device

Firmware version	01.00.zz	<ul style="list-style-type: none"> ▪ On the title page of the Operating Instructions ▪ On the transmitter nameplate →  12 ▪ Firmware version Diagnostics → Device information → Firmware version
Release date of firmware version	12.2017	---
Manufacturer ID	0x11	Manufacturer ID Diagnostics → Device information → Manufacturer ID
Device type ID	0x5c	Device type Diagnostics → Device information → Device type
Device revision	1	<ul style="list-style-type: none"> ▪ On the transmitter nameplate →  12 ▪ Device revision Diagnostics → Device information → Device revision



For an overview of the different firmware versions for the device

9.1.2 Operating tools

The suitable device description file for the individual operating tools is listed in the table below, along with information on where the file can be acquired.



DeviceCare	<ul style="list-style-type: none"> ▪ www.endress.com → Download Area ▪ CD-ROM (contact Endress+Hauser) ▪ DVD (contact Endress+Hauser)
------------	---

10 Commissioning

i Parameter configuration only possible in non-custody transfer mode (order code for "Output", option K "Pulse/frequency output").

10.1 Function check

Before commissioning the measuring device:

- ▶ Make sure that the post-installation and post-connection checks have been performed.
- "Post-installation check" checklist →  20
- "Post-connection check" checklist →  26

10.2 Configuring the measuring device

The **Setup** menu with its submenus contains all the parameters needed for standard operation.

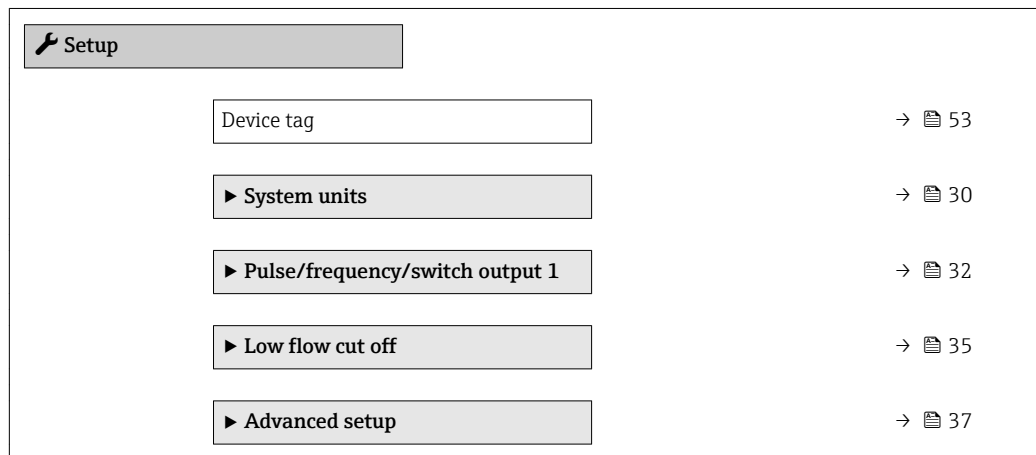

10.2.1 Defining the tag name

To enable fast identification of the measuring point within the system, you can enter a unique designation using the **Device tag** parameter and thus change the factory setting.

Navigation

"Setup" menu → Device tag

Parameter overview with brief description

Parameter	Description	User entry	Factory setting
Device tag	Enter the name for the measuring point.	Max. 32 characters, such as letters, numbers or special characters (e.g. @, %, /).	Prosonic Flow

10.2.2 Setting the system units

In the **System units** submenu the units of all the measured values can be set.

Navigation

"Setup" menu → System units

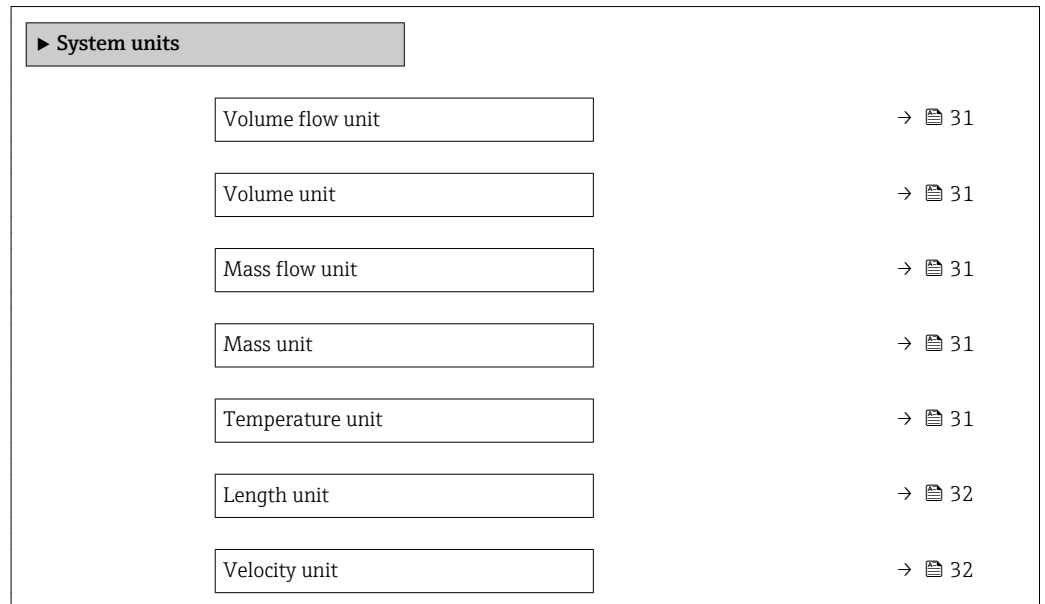

Parameter overview with brief description

Parameter	Description	Selection	Factory setting
Volume flow unit	Select volume flow unit. <i>Result</i> The selected unit applies for: <ul style="list-style-type: none"> ▪ Output ▪ Low flow cut off ▪ Simulation process variable 	Unit choose list	Country-specific: <ul style="list-style-type: none"> ▪ m³/h ▪ ft³/min
Volume unit	Select volume unit.	Unit choose list	Country-specific: <ul style="list-style-type: none"> ▪ dm³ ▪ ft³
Mass flow unit	Select mass flow unit. <i>Result</i> The selected unit applies for: <ul style="list-style-type: none"> ▪ Output ▪ Low flow cut off ▪ Simulation process variable 	Unit choose list	Country-specific: <ul style="list-style-type: none"> ▪ kg/h ▪ lb/min
Mass unit	Select mass unit.	Unit choose list	Country-specific: <ul style="list-style-type: none"> ▪ kg ▪ lb
Temperature unit	Select temperature unit. <i>Result</i> The selected unit applies for: <ul style="list-style-type: none"> ▪ Temperature ▪ Maximum value ▪ Minimum value ▪ Maximum value ▪ Minimum value 	Unit choose list	Country-specific: <ul style="list-style-type: none"> ▪ °C ▪ °F

Parameter	Description	Selection	Factory setting
Length unit	Select length unit for nominal diameter.	Unit choose list	Country-specific: <ul style="list-style-type: none"> ▪ mm ▪ in
Velocity unit	Select velocity unit. <i>Result</i> The selected unit applies for: <ul style="list-style-type: none"> ▪ Flow velocity ▪ Sound velocity ▪ Maximum value ▪ Minimum value ▪ Maximum value ▪ Minimum value 	Unit choose list	Country-specific: <ul style="list-style-type: none"> ▪ m/s ▪ ft/s

10.2.3 Configuring the pulse/frequency output



The **Pulse/frequency/switch output** submenu contains all the parameters that must be configured for the configuration of the selected output type.

Navigation

"Setup" menu → Pulse/frequency/switch output 1

Structure of the "Pulse/frequency/switch output 1" submenu

► Pulse/frequency/switch output 1	
Operating mode	→ 33
Assign pulse output 1	→ 33
Assign frequency output	→ 34
Value per pulse	→ 33
Pulse width	→ 33
Failure mode	→ 33
Minimum frequency value	→ 34
Maximum frequency value	→ 34
Measuring value at minimum frequency	→ 34
Measuring value at maximum frequency	→ 34
Damping output 1	→ 34
Failure mode	→ 34



Failure frequency	→  35
Invert output signal	→  33

Configuring the pulse output

Navigation

"Setup" menu → Pulse/frequency/switch output 1

Parameter overview with brief description

Parameter	Prerequisite	Description	Selection / User entry	Factory setting
Operating mode	–	Define output as pulse or frequency output.	<ul style="list-style-type: none"> ▪ Pulse ▪ Frequency 	Pulse
Assign pulse output 1	The Pulse option is selected in the Operating mode parameter.	Select process variable for pulse output.	<ul style="list-style-type: none"> ▪ Off ▪ Volume flow ▪ Mass flow 	Off
Value per pulse	In the Operating mode parameter, the Pulse option is selected, and one of the following options is selected in the Assign pulse output parameter (→  33): <ul style="list-style-type: none"> ▪ Volume flow ▪ Mass flow 	Enter measured value at which a pulse is output.	Signed floating-point number	Depends on country and nominal diameter
Pulse width	In the Operating mode parameter, the Pulse option is selected, and one of the following options is selected in the Assign pulse output parameter (→  33): <ul style="list-style-type: none"> ▪ Volume flow ▪ Mass flow 	Define time width of the output pulse.	0.05 to 2 000 ms	100 ms
Failure mode	In the Operating mode parameter, the Pulse option is selected, and one of the following options is selected in the Assign pulse output parameter (→  33): <ul style="list-style-type: none"> ▪ Volume flow ▪ Mass flow 	Define output behavior in alarm condition.	<ul style="list-style-type: none"> ▪ Actual value ▪ No pulses 	No pulses
Invert output signal	–	Invert the output signal.	<ul style="list-style-type: none"> ▪ No ▪ Yes 	No

Configuring the frequency output

Navigation

"Setup" menu → Pulse/frequency/switch output 1

Parameter overview with brief description

Parameter	Prerequisite	Description	Selection / User entry	Factory setting
Operating mode	–	Define output as pulse or frequency output.	<ul style="list-style-type: none"> ▪ Pulse ▪ Frequency 	Pulse
Assign frequency output	The Frequency option is selected in the Operating mode parameter (→ 33) parameter.	Select process variable for frequency output.	<ul style="list-style-type: none"> ▪ Off ▪ Volume flow ▪ Mass flow ▪ Temperature 	Off
Minimum frequency value	In the Operating mode parameter, the Frequency option is selected, and one of the following options is selected in the Assign frequency output parameter (→ 34): <ul style="list-style-type: none"> ▪ Volume flow ▪ Mass flow 	Enter minimum frequency.	0.0 to 10 000.0 Hz	0.0 Hz
Maximum frequency value	In the Operating mode parameter, the Frequency option is selected, and one of the following options is selected in the Assign frequency output parameter (→ 34): <ul style="list-style-type: none"> ▪ Volume flow ▪ Mass flow 	Enter maximum frequency.	0.0 to 10 000.0 Hz	10 000.0 Hz
Measuring value at minimum frequency	In the Operating mode parameter, the Frequency option is selected, and one of the following options is selected in the Assign frequency output parameter (→ 34): <ul style="list-style-type: none"> ▪ Volume flow ▪ Mass flow 	Enter measured value for minimum frequency.	Signed floating-point number	Depends on country and nominal diameter
Measuring value at maximum frequency	In the Operating mode parameter, the Frequency option is selected, and one of the following options is selected in the Assign frequency output parameter (→ 34): <ul style="list-style-type: none"> ▪ Volume flow ▪ Mass flow 	Enter measured value for maximum frequency.	Signed floating-point number	Depends on country and nominal diameter
Damping output 1	In the Operating mode parameter, the Frequency option is selected, and one of the following options is selected in the Assign frequency output parameter (→ 34): <ul style="list-style-type: none"> ▪ Volume flow ▪ Mass flow 	Set reaction time for output signal to fluctuations in the measured value.	0 to 999.9 s	0.0 s
Failure mode	In the Operating mode parameter, the Frequency option is selected, and one of the following options is selected in the Assign frequency output parameter (→ 34): <ul style="list-style-type: none"> ▪ Volume flow ▪ Mass flow 	Define output behavior in alarm condition.	<ul style="list-style-type: none"> ▪ Actual value ▪ Defined value ▪ 0 Hz 	0 Hz

Parameter	Prerequisite	Description	Selection / User entry	Factory setting
Failure frequency	In the Operating mode parameter, the Frequency option is selected, and one of the following options is selected in the Assign frequency output parameter (→ 34): <ul style="list-style-type: none"> ▪ Volume flow ▪ Mass flow 	Enter frequency output value in alarm condition.	0.0 to 12 500.0 Hz	0.0 Hz
Invert output signal	–	Invert the output signal.	<ul style="list-style-type: none"> ▪ No ▪ Yes 	No

10.2.4 Configuring the low flow cut off

The **Low flow cut off** submenu contains the parameters that must be set in order to configure the low flow cut off.

Structure of the wizard

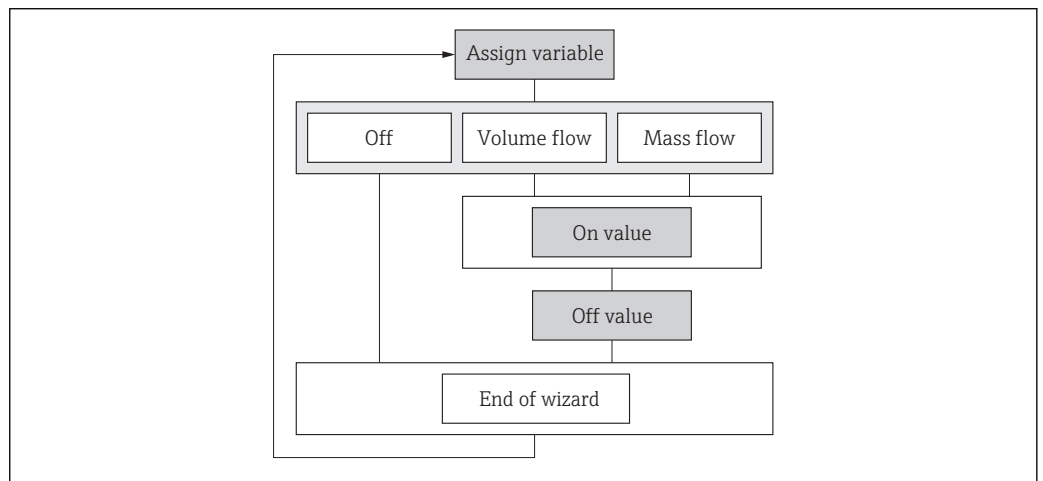

9 "Low flow cutoff" wizard in the "Setup" menu

Navigation

"Setup" menu → Low flow cut off

▶ **Low flow cut off**

Assign process variable
→ 36

On value low flow cutoff
→ 36

Off value low flow cutoff
→ 36

Parameter overview with brief description

Parameter	Prerequisite	Description	Selection / User entry	Factory setting
Assign process variable	–	Select process variable for low flow cut off.	<ul style="list-style-type: none"> ▪ Off ▪ Volume flow ▪ Mass flow 	Off
On value low flow cutoff	In the Assign process variable parameter (→ 36), one of the following options is selected: <ul style="list-style-type: none"> ▪ Volume flow ▪ Mass flow 	Enter on value for low flow cut off.	Positive floating-point number	Depends on country and nominal diameter
Off value low flow cutoff	In the Assign process variable parameter (→ 36), one of the following options is selected: <ul style="list-style-type: none"> ▪ Volume flow ▪ Mass flow 	Enter off value for low flow cut off.	0 to 100.0 %	50 %

10.3 Advanced settings

The **Advanced setup** submenu together with its submenus contains parameters for specific settings.

Navigation

"Setup" menu → Advanced setup

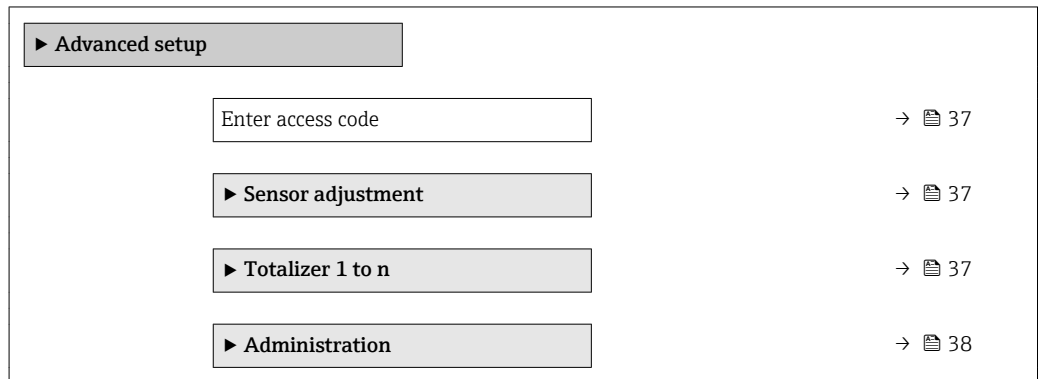

10.3.1 Using the parameter to enter the access code

Navigation

"Setup" menu → Advanced setup

Parameter overview with brief description

Parameter	Description	User entry
Enter access code	Enter access code to disable write protection of parameters.	0 to 9999

10.3.2 Carrying out a sensor adjustment

The **Sensor adjustment** submenu contains parameters that pertain to the functionality of the sensor.

Navigation

"Setup" menu → Advanced setup → Sensor adjustment

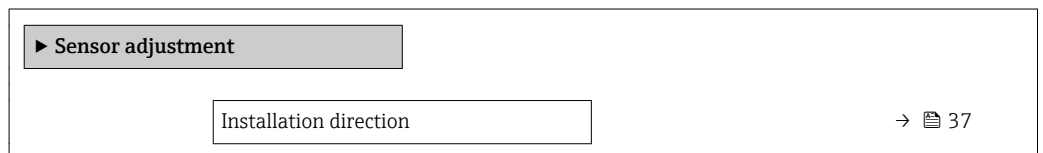

Parameter overview with brief description

Parameter	Description	Selection	Factory setting
Installation direction	Set sign of flow direction to match the direction of the arrow on the sensor.	<ul style="list-style-type: none"> ▪ Flow in arrow direction ▪ Flow against arrow direction 	Flow in arrow direction

10.3.3 Configuring the totalizer

In the **"Totalizer 1 to n"** submenu the individual totalizer can be configured.

Navigation

"Setup" menu → Advanced setup → Totalizer 1 to n

<p>► Totalizer 1 to n</p>		
Assign process variable		→ 38
Unit totalizer		→ 38
Totalizer operation mode		→ 38
Failure mode		→ 38

Parameter overview with brief description

Parameter	Prerequisite	Description	Selection	Factory setting
Assign process variable	-	Select process variable for totalizer.	<ul style="list-style-type: none"> ▪ Off ▪ Volume flow ▪ Mass flow 	Volume flow
Unit totalizer	One of the following options is selected in the Assign process variable parameter (→ 38) of the Totalizer 1 to n submenu: <ul style="list-style-type: none"> ▪ Volume flow ▪ Mass flow 	Select process variable totalizer unit.	Unit choose list	Country-specific: <ul style="list-style-type: none"> ▪ m³ ▪ ft³
Totalizer operation mode	One of the following options is selected in the Assign process variable parameter (→ 38) of the Totalizer 1 to n submenu: <ul style="list-style-type: none"> ▪ Volume flow ▪ Mass flow 	Select totalizer calculation mode.	<ul style="list-style-type: none"> ▪ Net flow total ▪ Forward flow total ▪ Reverse flow total 	Net flow total
Failure mode	One of the following options is selected in the Assign process variable parameter (→ 38) of the Totalizer 1 to n submenu: <ul style="list-style-type: none"> ▪ Volume flow ▪ Mass flow 	Define totalizer behavior in alarm condition.	<ul style="list-style-type: none"> ▪ Stop ▪ Actual value ▪ Last valid value 	Stop

10.3.4 Using parameters for device administration

The **Administration** submenu systematically guides the user through all the parameters that can be used for device administration purposes.

Navigation

"Setup" menu → Advanced setup → Administration

<p>► Administration</p>		
Device reset		→ 39

Parameter overview with brief description

Parameter	Description	Selection	Factory setting
Device reset	Reset the device configuration - either entirely or in part - to a defined state.	<ul style="list-style-type: none"> ■ Cancel ■ To delivery settings ■ Restart device ■ Restore S-DAT backup 	Cancel

10.4 Simulation

The **Simulation** submenu enables you to simulate, without a real flow situation, various process variables in the process and the device alarm mode and to verify downstream signal chains (switching valves or closed-control loops).

Navigation

"Diagnostics" menu → Simulation

<div style="border: 1px solid black; padding: 5px;"> <div style="background-color: #cccccc; padding: 2px 5px; margin-bottom: 5px;">▶ Simulation</div> <div style="display: flex; justify-content: space-between; align-items: center; margin-bottom: 5px;"> <div style="border: 1px solid black; padding: 2px 10px;">Assign simulation process variable</div> <div style="text-align: right;">→ ⓘ 39</div> </div> <div style="display: flex; justify-content: space-between; align-items: center; margin-bottom: 5px;"> <div style="border: 1px solid black; padding: 2px 10px;">Process variable value</div> <div style="text-align: right;">→ ⓘ 39</div> </div> <div style="display: flex; justify-content: space-between; align-items: center; margin-bottom: 5px;"> <div style="border: 1px solid black; padding: 2px 10px;">Device alarm simulation</div> <div style="text-align: right;">→ ⓘ 39</div> </div> <div style="display: flex; justify-content: space-between; align-items: center;"> <div style="border: 1px solid black; padding: 2px 10px;">Diagnostic event simulation</div> <div style="text-align: right;">→ ⓘ 40</div> </div> </div>	
--	--

Parameter overview with brief description

Parameter	Prerequisite	Description	Selection / User entry	Factory setting
Assign simulation process variable	–	Select a process variable for the simulation process that is activated.	<ul style="list-style-type: none"> ■ Off ■ Volume flow ■ Mass flow ■ Sound velocity ■ Flow velocity ■ Temperature 	Off
Process variable value	In the Assign simulation process variable parameter (→ ⓘ 39), one of the following options is selected: <ul style="list-style-type: none"> ■ Volume flow ■ Mass flow ■ Sound velocity ■ Flow velocity ■ Temperature * 	Enter the simulation value for the selected process variable.	Depends on the process variable selected	0
Device alarm simulation	–	Switch the device alarm on and off.	<ul style="list-style-type: none"> ■ Off ■ On 	Off

Parameter	Prerequisite	Description	Selection / User entry	Factory setting
Diagnostic event category	–	Select a diagnostic event category.	<ul style="list-style-type: none">▪ Sensor▪ Electronics▪ Configuration▪ Process	Sensor
Diagnostic event simulation	–	Select a diagnostic event to simulate this event.	<ul style="list-style-type: none">▪ Off▪ Diagnostic event picklist (depends on the category selected)	Off

* Visibility depends on order options or device settings

11 Operation

11.1 Reading the device locking status

Device active write protection: **Locking status** parameter

Navigation

"Operation" menu → Locking status

Function scope of the "Locking status" parameter

Options	Description
CT active - all parameters	Write access to all parameters is locked (via the operating tool).
Temporarily locked	Write access to the parameters is temporarily locked on account of internal processes running in the device (e.g. data upload/download, reset etc.). Once the internal processing has been completed, the parameters can be changed once again.

11.2 Reading measured values

With the **Measured values** submenu, it is possible to read all the measured values.

11.2.1 Process variables

The **Process variables** submenu contains all the parameters needed to display the current measured values for each process variable.

Navigation

"Diagnostics" menu → Measured values → Process variables

► Process variables	
Volume flow	→ ⓘ 42
Mass flow	→ ⓘ 42
Sound velocity	→ ⓘ 42
Flow velocity	→ ⓘ 42
Temperature	→ ⓘ 42

Parameter overview with brief description

Parameter	Description	User interface
Volume flow	Displays the volume flow currently measured. <i>Dependency</i> The unit is taken from the Volume flow unit parameter (→ 31).	Signed floating-point number
Mass flow	Displays the mass flow currently calculated. <i>Dependency</i> The unit is taken from the Mass flow unit parameter (→ 31).	Signed floating-point number
Sound velocity	Displays the sound velocity currently measured. <i>Dependency</i> The unit is taken from the Velocity unit parameter.	Signed floating-point number
Flow velocity	Displays the flow velocity currently measured. <i>Dependency</i> The unit is taken from the Velocity unit parameter.	Signed floating-point number
Temperature	Displays the temperature currently measured. <i>Dependency</i> The unit is taken from the Temperature unit parameter.	Signed floating-point number

11.2.2 System values

The **System values** submenu contains all the parameters needed to display the current measured values for every system value.

Diagnostics → Measured values → System values

Navigation

"Diagnostics" menu → Measured values → System values

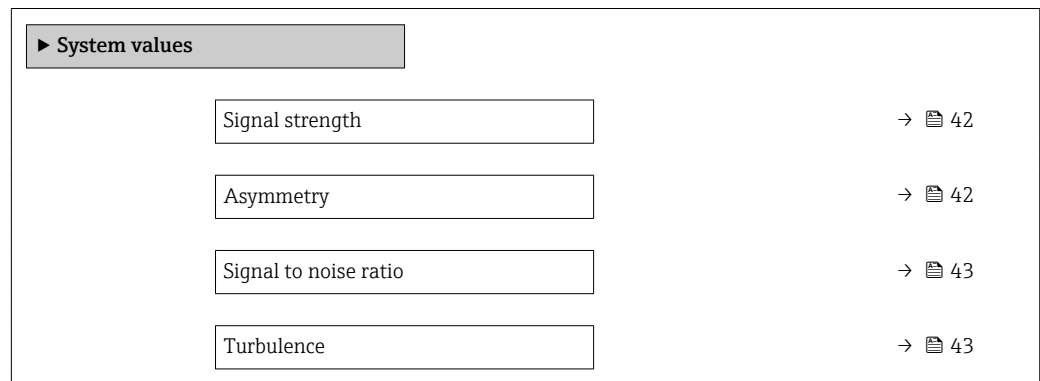

Parameter overview with brief description

Parameter	Prerequisite	Description	User interface	Factory setting
Signal strength	–	Displays the current signal strength.	Signed floating-point number	–
Asymmetry	The Dual path sensor option is selected in the Path configuration parameter.	Displays the asymmetry of the measured values between signal path 1 and signal path 2.	Signed floating-point number	0 %

Parameter	Prerequisite	Description	User interface	Factory setting
Signal to noise ratio	-	Displays the current signal-to-noise ratio.	Signed floating-point number	-
Turbulence	-	Displays the current turbulence.	Signed floating-point number	-

11.2.3 "Totalizer" submenu

The **Totalizer** submenu contains all the parameters needed to display the current measured values for every totalizer.

Navigation

"Diagnostics" menu → Measured values → Totalizer

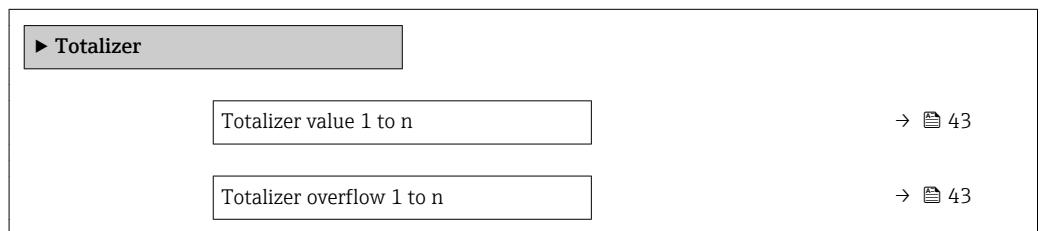

Parameter overview with brief description

Parameter	Prerequisite	Description	User interface
Totalizer value	One of the following options is selected in the Assign process variable parameter (→ 38) of the Totalizer 1 to n submenu: <ul style="list-style-type: none"> ▪ Volume flow ▪ Mass flow 	Displays the current totalizer counter value.	Signed floating-point number
Totalizer overflow	One of the following options is selected in the Assign process variable parameter (→ 38) of the Totalizer 1 to n submenu: <ul style="list-style-type: none"> ▪ Volume flow ▪ Mass flow 	Displays the current totalizer overflow.	Integer with sign

11.3 Adapting the measuring device to the process conditions

The following are available for this purpose:

- Basic settings using the **Setup** menu (→ 30)
- Advanced settings using the **Advanced setup** submenu (→ 37)

11.4 Performing a totalizer reset

The totalizers are reset in the **Operation** submenu:

- Control Totalizer
- Reset all totalizers

Navigation

"Operation" menu → Totalizer handling

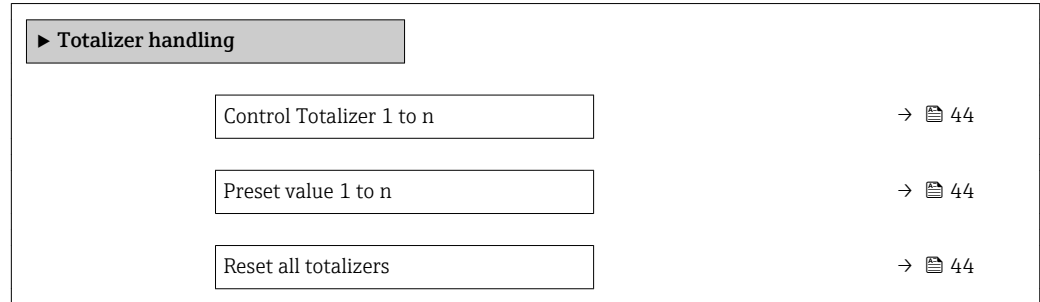

Parameter overview with brief description

Parameter	Prerequisite	Description	Selection / User entry	Factory setting
Control Totalizer	One of the following options is selected in the Assign process variable parameter (→ 38) of the Totalizer 1 to n submenu: <ul style="list-style-type: none"> Volume flow Mass flow 	Control totalizer value.	<ul style="list-style-type: none"> Totalize Reset + hold Preset + hold Reset + totalize Preset + totalize Hold 	Totalize
Preset value	One of the following options is selected in the Assign process variable parameter (→ 38) of the Totalizer 1 to n submenu: <ul style="list-style-type: none"> Volume flow Mass flow 	Specify start value for totalizer. <i>Dependency</i>  The unit of the selected process variable is specified for the totalizer in the Unit totalizer parameter (→ 38).	Signed floating-point number	Country-specific: <ul style="list-style-type: none"> 0 m³ 0 ft³
Reset all totalizers	–	Reset all totalizers to 0 and start.	<ul style="list-style-type: none"> Cancel Reset + totalize 	Cancel

11.4.1 Function scope of the "Control Totalizer" parameter

Options	Description
Totalize	The totalizer is started or continues running.
Reset + hold	The totaling process is stopped and the totalizer is reset to 0.
Preset + hold	The totaling process is stopped and the totalizer is set to its defined start value from the Preset value parameter.
Reset + totalize	The totalizer is reset to 0 and the totaling process is restarted.
Preset + totalize	The totalizer is set to the defined start value from the Preset value parameter and the totaling process is restarted.

11.4.2 Function scope of the "Reset all totalizers" parameter

Options	Description
Cancel	No action is executed and the user exits the parameter.
Reset + totalize	Resets all totalizers to 0 and restarts the totaling process. This deletes all the flow values previously totalized.

12 Diagnostics and troubleshooting

12.1 General troubleshooting



For output signals

Error	Possible causes	Solution
Green power LED on the main electronics module of the transmitter is dark	Supply voltage does not match the value indicated on the nameplate.	Apply the correct supply voltage .
Device measures incorrectly.	Configuration error or device is operated outside the application.	1. Check and correct parameter configuration. 2. Observe limit values specified in the "Technical Data".

12.2 Diagnostic information via light emitting diodes

12.2.1 Transmitter

Different LEDs in the transmitter provide information on the device status.

Visibility of LEDs	
	Order code for "Housing", option A "Compact, aluminum coated"
	Order code for "Housing", option B "Compact, aluminum coated + window"

LED	Color	Meaning
Supply voltage	Off	Supply voltage is off or too low
	Green	Supply voltage is ok
Alarm	Off	Device status is ok
	Flashing red	A device error of diagnostic behavior "Warning" has occurred
	Red	<ul style="list-style-type: none"> ▪ A device error of diagnostic behavior "Alarm" has occurred ▪ Boot loader is active

12.3 Diagnostic information in FieldCare or DeviceCare

12.3.1 Diagnostic options

Any faults detected by the measuring device are displayed on the home page of the operating tool once the connection has been established.

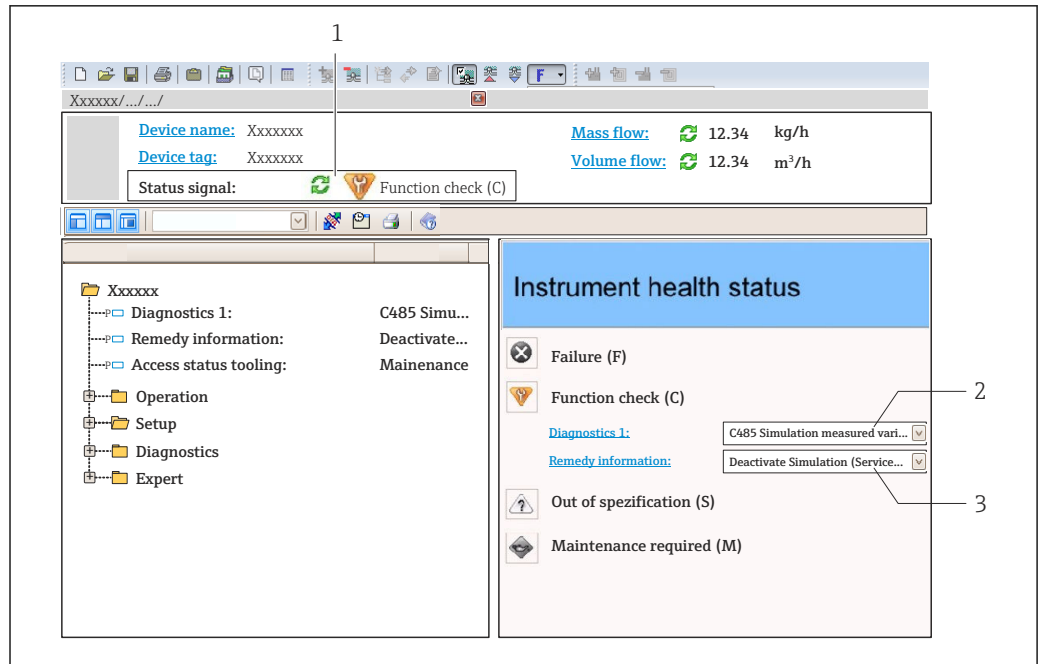

A0021799-EN

- 1 Status area with status signal
- 2 Diagnostic information → 46
- 3 Remedy information with Service ID

i In addition, diagnostic events which have occurred can be shown in the **Diagnostics** menu:

- Via parameter
- Via submenu → 50

Diagnostic information

The fault can be identified using the diagnostic information. The short text helps you by providing information about the fault.

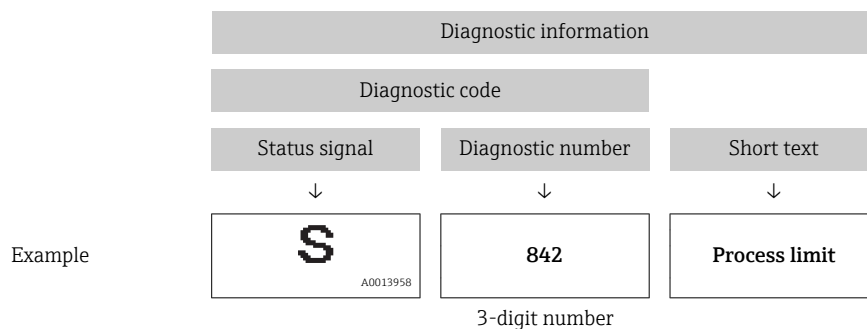

12.3.2 Calling up remedy information

Remedy information is provided for every diagnostic event to ensure that problems can be rectified quickly:

- On the home page
Remedy information is displayed in a separate field below the diagnostics information.
- In the **Diagnostics** menu
Remedy information can be called up in the working area of the user interface.

The user is in the **Diagnostics** menu.

1. Call up the desired parameter.

2. On the right in the working area, mouse over the parameter.
 - ↳ A tool tip with remedy information for the diagnostic event appears.

12.4 Adapting the diagnostic information

12.4.1 Adapting the diagnostic behavior



Each item of diagnostic information is assigned a specific diagnostic behavior at the factory. The user can change this assignment for specific diagnostic information in the **Diagnostic behavior** submenu.

Expert → System → Diagnostic handling → Diagnostic behavior

You can assign the following options to the diagnostic number as the diagnostic behavior:

Options	Description
Alarm	The device stops measurement. The signal outputs and totalizers assume the defined alarm condition. A diagnostic message is generated.
Warning	The device continues to measure. The signal outputs and totalizers are not affected. A diagnostic message is generated.
Logbook entry only	
Off	The diagnostic event is ignored, and no diagnostic message is generated or entered.

12.5 Overview of diagnostic information

-  The amount of diagnostic information and the number of measured variables affected increase if the measuring device has one or more application packages.
-  In the case of some items of diagnostic information, the diagnostic behavior can be changed. Change the diagnostic information

Diagnostic number	Short text	Remedy instructions	Status signal [from the factory]	Diagnostic behavior [from the factory]
Diagnostic of sensor				
022	Temperature sensor defective	1. Replace sensor electronic module (ISEM) 2. Replace device	F	Alarm
082	Data storage	1. Check module connections 2. Contact service	F	Alarm
083	Memory content	1. Restart device 2. Restore HistoROM S-DAT backup ('Device reset' parameter) 3. Replace HistoROM S-DAT	F	Alarm
104	Sensor signal path 1 to n	1. Check process conditions 2. Replace sensor electronic module (ISEM) 3. Replace device	F	Alarm
105	Downstream transducer path 1 to n defective	Replace device	F	Alarm
106	Upstream transducer path 1 to n defective	Replace device	F	Alarm

Diagnostic number	Short text	Remedy instructions	Status signal [from the factory]	Diagnostic behavior [from the factory]
124	Relative signal strength	1. Check or replace connection cable between sensor electronic module (ISEM) and main electronics 2. Check or replace ISEM or main electronics	M	Warning
125	Relative sound velocity	Check process conditions	M	Warning
160	Signal path switched off	Contact service	M	Warning ¹⁾
Diagnostic of electronic				
201	Device failure	1. Restart device 2. Contact service	F	Alarm
242	Software incompatible	1. Check software 2. Flash or change main electronics module	F	Alarm
270	Main electronic failure	Change main electronic module	F	Alarm
271	Main electronic failure	1. Restart device 2. Change main electronic module	F	Alarm
302	Device verification active	Device verification active, please wait.	C	Warning
311	Electronic failure	1. Do not reset device 2. Contact service	M	Warning
372	Sensor electronic (ISEM) faulty	1. Restart device 2. Check if failure recurs 3. Replace sensor electronic module (ISEM)	F	Alarm
373	Sensor electronic (ISEM) faulty	1. Transfer data or reset device 2. Contact service	F	Alarm
384	Transmitter circuit	1. Restart device 2. Check if failure recurs 3. Replace sensor electronic module (ISEM)	F	Alarm
385	Amplifier circuit	1. Restart device 2. Check if failure recurs 3. Replace sensor electronic module (ISEM)	F	Alarm
386	Time of flight	1. Restart device 2. Check if failure recurs 3. Replace sensor electronic module (ISEM)	F	Alarm
Diagnostic of configuration				
410	Data transfer	1. Check connection 2. Retry data transfer	F	Alarm
412	Processing download	Download active, please wait	C	Warning
437	Configuration incompatible	1. Restart device 2. Contact service	F	Alarm
438	Dataset	1. Check data set file 2. Check device configuration 3. Up- and download new configuration	M	Warning
442	Frequency output	1. Check process 2. Check frequency output settings	S	Warning



Diagnostic number	Short text	Remedy instructions	Status signal [from the factory]	Diagnostic behavior [from the factory]
443	Pulse output	1. Check process 2. Check pulse output settings	S	Warning
453	Flow override	Deactivate flow override	C	Warning
484	Failure mode simulation	Deactivate simulation	C	Alarm
485	Measured variable simulation	Deactivate simulation	C	Warning
492	Simulation frequency output	Deactivate simulation frequency output	C	Warning
493	Simulation pulse output	Deactivate simulation pulse output	C	Warning
494	Switch output simulation	Deactivate simulation switch output	C	Warning
495	Diagnostic event simulation	Deactivate simulation	C	Warning
540	Custody transfer mode failed	Device restart active, please wait	F	Alarm
Diagnostic of process				
832	Electronic temperature too high	Reduce ambient temperature	S	Warning
833	Electronic temperature too low	Increase ambient temperature	S	Warning
834	Process temperature too high	Reduce process temperature	S	Warning
835	Process temperature too low	Increase process temperature	S	Warning
841	Sensor range	Check flow velocity	S	Warning
841	Sensor range		S	Warning ¹⁾
842	Process limit	Low flow cut off active! 1. Check low flow cut off configuration	S	Warning
881	Sensor signal path 1 to n	1. Check process conditions 2. Replace sensor electronic module (ISEM) 3. Replace device	M	Warning
930	Process fluid	Sound velocity too high! Check process conditions	S	Warning
931	Process fluid	Sound velocity too low! Check process conditions	S	Warning



1) Diagnostic behavior can be changed.

12.6 Pending diagnostic events

The **Diagnostics** menu allows the user to view the current diagnostic event and the previous diagnostic event separately.

 To call up the measures to rectify a diagnostic event:

- Via "FieldCare" operating tool →  46
- Via "DeviceCare" operating tool →  46

 Other pending diagnostic events can be displayed in the **Diagnostic list** submenu →  50

Navigation

"Diagnostics" menu

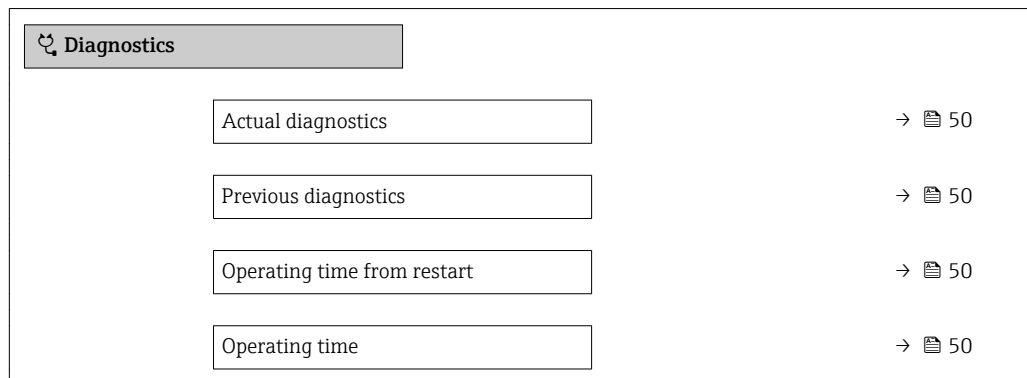
**Parameter overview with brief description**



Parameter	Prerequisite	Description	User interface
Actual diagnostics	A diagnostic event has occurred.	Shows the current occurred diagnostic event along with its diagnostic information.  If two or more messages occur simultaneously, the message with the highest priority is shown on the display.	Symbol for diagnostic behavior, diagnostic code and short message.
Previous diagnostics	Two diagnostic events have already occurred.	Shows the diagnostic event that occurred prior to the current diagnostic event along with its diagnostic information.	Symbol for diagnostic behavior, diagnostic code and short message.
Operating time from restart	-	Shows the time the device has been in operation since the last device restart.	Days (d), hours (h), minutes (m) and seconds (s)
Operating time	-	Indicates how long the device has been in operation.	Days (d), hours (h), minutes (m) and seconds (s)

12.7 Diagnostic list

Up to 5 currently pending diagnostic events can be displayed in the **Diagnostic list** submenu along with the associated diagnostic information. If more than 5 diagnostic events are pending, the events with the highest priority are shown on the display.

Navigation path

Diagnostics → Diagnostic list

-  To call up the measures to rectify a diagnostic event:
- Via "FieldCare" operating tool →  46
 - Via "DeviceCare" operating tool →  46

12.8 Event logbook**12.8.1 Reading out the event logbook**



A chronological overview of the event messages that have occurred is provided in the **Events list** submenu.

Navigation path



Diagnostics menu → **Event logbook** submenu → Event list

A maximum of 20 event messages can be displayed in chronological order.



The event history includes entries for:

- Diagnostic events →  47
- Information events →  51

In addition to the operation time of its occurrence, each event is also assigned a symbol that indicates whether the event has occurred or is ended:

- Diagnostic event
 - : Occurrence of the event
 - : End of the event
- Information event
 - : Occurrence of the event

 To call up the measures to rectify a diagnostic event:

- Via "FieldCare" operating tool →  46
- Via "DeviceCare" operating tool →  46

 For filtering the displayed event messages →  51

12.8.2 Filtering the event logbook

Using the **Filter options** parameter you can define which category of event message is displayed in the **Events list** submenu.

Navigation path

Diagnostics → Event logbook → Filter options

Filter categories

- All
- Failure (F)
- Function check (C)
- Out of specification (S)
- Maintenance required (M)
- Information (I)

12.8.3 Overview of information events

Unlike a diagnostic event, an information event is displayed in the event logbook only and not in the diagnostic list.

Info number	Info name
I1000	------(Device ok)
I1079	Sensor changed
I1089	Power on
I1090	Configuration reset
I1091	Configuration changed
I1110	Write protection switch changed
I1137	Electronic changed
I1151	History reset
I1155	Reset electronic temperature
I1157	Memory error event list
I1256	Display: access status changed
I1264	Safety sequence aborted

Info number	Info name
I1327	Zero point adjust failed signal path
I1335	Firmware changed
I1397	Fieldbus: access status changed
I1398	CDI: access status changed
I1444	Device verification passed
I1445	Device verification failed
I1459	I/O module verification failed
I1461	Sensor verification failed
I1462	Sensor electronic module verific. failed
I1512	Download started
I1513	Download finished
I1514	Upload started
I1515	Upload finished
I1624	Reset all totalizers
I1629	CDI: login successful
I1634	Reset to factory settings
I1649	Hardware write protection activated
I1650	Hardware write protection deactivated

12.9 Resetting the measuring device

Using the **Device reset** parameter (→  39) it is possible to reset the entire device configuration or some of the configuration to a defined state.

12.9.1 Function scope of the "Device reset" parameter

Options	Description
Cancel	No action is executed and the user exits the parameter.
To delivery settings	Every parameter for which a customer-specific default setting was ordered is reset to this customer-specific value. All other parameters are reset to the factory setting.  This option is not visible if no customer-specific settings have been ordered.
Restart device	The restart resets every parameter whose data are in the volatile memory (RAM) to the factory setting (e.g. measured value data). The device configuration remains unchanged.

12.10 Device information



The **Device information** submenu contains all parameters that display different information for device identification.



Navigation

"Diagnostics" menu → Device information

▶ Device information		
Device tag		→ 53
Serial number		→ 53
Firmware version		→ 53
Device name		→ 53
Order code		→ 53
Extended order code 1		→ 53
Extended order code 2		→ 54
Extended order code 3		→ 54
ENP version		→ 54

Parameter overview with brief description

Parameter	Description	User interface	Factory setting
Device tag	Shows name of measuring point.	Max. 32 characters, such as letters, numbers or special characters (e.g. @, %, /).	Prosonic Flow E Heat
Serial number	Shows the serial number of the measuring device.	Max. 11-digit character string comprising letters and numbers.	–
Firmware version	Shows the device firmware version installed.	Character string in the format xx.yy.zz	–
Device name	Shows the name of the transmitter.  The name can be found on the nameplate of the transmitter.	Max. 32 characters such as letters or numbers.	Pros.Flow E Heat
Order code	Shows the device order code.  The order code can be found on the nameplate of the sensor and transmitter in the "Order code" field.	Character string composed of letters, numbers and certain punctuation marks (e.g. /).	–
Extended order code 1	Shows the 1st part of the extended order code.  The extended order code can also be found on the nameplate of the sensor and transmitter in the "Ext. ord. cd." field.	Character string	–

Parameter	Description	User interface	Factory setting
Extended order code 2	Shows the 2nd part of the extended order code.  The extended order code can also be found on the nameplate of the sensor and transmitter in the "Ext. ord. cd." field.	Character string	–
Extended order code 3	Shows the 3rd part of the extended order code.  The extended order code can also be found on the nameplate of the sensor and transmitter in the "Ext. ord. cd." field.	Character string	–
ENP version	Shows the version of the electronic nameplate (ENP).	Character string	2.02.00

12.11 Firmware history

 It is possible to flash the firmware to the current version or the previous version using the service interface.

 For the compatibility of the firmware version with the previous version, the installed device description files and operating tools, observe the information about the device in the "Manufacturer's information" document.

 The manufacturer's information is available:

- In the Download Area of the Endress+Hauser web site: www.endress.com → Downloads
- Specify the following details:
 - Product root: e.g. 9EHB
The product root is the first part of the order code: see the nameplate on the device.
 - Text search: Manufacturer's information
 - Media type: Documentation – Technical Documentation

13 Maintenance

13.1 Maintenance tasks

No special maintenance work is required.

13.1.1 Exterior cleaning

When cleaning the exterior of measuring devices, always use cleaning agents that do not attack the surface of the housing or the seals.

13.2 Measuring and test equipment

Endress+Hauser offers a wide variety of measuring and test equipment, such as W@M or device tests.

 Your Endress+Hauser Sales Center can provide detailed information on the services.

List of some of the measuring and testing equipment: →  58

13.3 Endress+Hauser services

Endress+Hauser offers a wide variety of services for maintenance such as recalibration, maintenance service or device tests.

 Your Endress+Hauser Sales Center can provide detailed information on the services.

14 Repairs

14.1 General notes

14.1.1 Repair and conversion concept

The Endress+Hauser repair and conversion concept provides for the following:

- The measuring devices have a modular design.
- Spare parts are grouped into logical kits with the associated Installation Instructions.
- Repairs are carried out by Endress+Hauser Service or by appropriately trained customers.
- Certified devices can only be converted to other certified devices by Endress+Hauser Service or at the factory.

14.1.2 Notes for repair and conversion



For repair and modification of a measuring device, observe the following notes:

- ▶ Use only original Endress+Hauser spare parts.
- ▶ Carry out the repair according to the Installation Instructions.
- ▶ Observe the applicable standards, federal/national regulations, Ex documentation (XA) and certificates.
- ▶ Document every repair and each conversion and enter them into the *W@M* life cycle management database.

14.2 Spare parts

W@M Device Viewer (www.endress.com/deviceviewer):

All the spare parts for the measuring device, along with the order code, are listed here and can be ordered. If available, users can also download the associated Installation Instructions.

-  Measuring device serial number:
 - Is located on the nameplate of the device.
 - Can be read out via the **Serial number** parameter (→  53) in the **Device information** submenu.

14.3 Endress+Hauser services

Endress+Hauser offers a wide range of services.

-  Your Endress+Hauser Sales Center can provide detailed information on the services.

14.4 Return

The measuring device must be returned if it is need of repair or a factory calibration, or if the wrong measuring device has been delivered or ordered. Legal specifications require Endress+Hauser, as an ISO-certified company, to follow certain procedures when handling products that are in contact with the medium.

To ensure safe, swift and professional device returns, please refer to the procedure and conditions for returning devices provided on the Endress+Hauser website at <http://www.endress.com/support/return-material>

14.5 Disposal

14.5.1 Removing the measuring device

1. Switch off the device.

⚠ WARNING

Danger to persons from process conditions.

- ▶ Beware of hazardous process conditions such as pressure in the measuring device, high temperatures or aggressive fluids.

2. Carry out the mounting and connection steps from the "Mounting the measuring device" and "Connecting the measuring device" sections in reverse order. Observe the safety instructions.

14.5.2 Disposing of the measuring device

⚠ WARNING

Danger to personnel and environment from fluids that are hazardous to health.

- ▶ Ensure that the measuring device and all cavities are free of fluid residues that are hazardous to health or the environment, e.g. substances that have permeated into crevices or diffused through plastic.

Observe the following notes during disposal:

- ▶ Observe valid federal/national regulations.
- ▶ Ensure proper separation and reuse of the device components.



15 Accessories

Various accessories, which can be ordered with the device or subsequently from Endress+Hauser, are available for the device. Detailed information on the order code in question is available from your local Endress+Hauser sales center or on the product page of the Endress+Hauser website: www.endress.com.

15.1 Communication-specific accessories

Accessories	Description
Commubox FXA291	<p>Connects Endress+Hauser field devices with a CDI interface (= Endress+Hauser Common Data Interface) and the USB port of a computer or laptop.</p> <p> Technical Information TI405C/07</p>

15.2 Service-specific accessories

Accessories	Description
Applicator	<p>Software for selecting and sizing Endress+Hauser measuring devices:</p> <ul style="list-style-type: none"> ▪ Choice of measuring devices for industrial requirements ▪ Calculation of all the necessary data for identifying the optimum flowmeter: e.g. nominal diameter, pressure loss, flow velocity and accuracy. ▪ Graphic illustration of the calculation results ▪ Determination of the partial order code, administration, documentation and access to all project-related data and parameters over the entire life cycle of a project. <p>Applicator is available:</p> <ul style="list-style-type: none"> ▪ Via the Internet: https://portal.endress.com/webapp/applicator ▪ As a downloadable DVD for local PC installation.
W@M	<p>W@M Life Cycle Management</p> <p>Improved productivity with information at your fingertips. Data relevant to a plant and its components is generated from the first stages of planning and during the asset's complete life cycle.</p> <p>W@M Life Cycle Management is an open and flexible information platform with online and on-site tools. Instant access for your staff to current, in-depth data shortens your plant's engineering time, speeds up procurement processes and increases plant uptime.</p> <p>Combined with the right services, W@M Life Cycle Management boosts productivity in every phase. For more information, visit www.endress.com/lifecyclemanagement</p>
FieldCare	<p>FDT-based plant asset management tool from Endress+Hauser.</p> <p>It can configure all smart field units in your system and helps you manage them. By using the status information, it is also a simple but effective way of checking their status and condition.</p> <p> Operating Instructions BA00027S and BA00059S</p>
DeviceCare	<p>Tool to connect and configure Endress+Hauser field devices.</p> <p> Innovation brochure IN01047S</p>

15.3 System components

Accessories	Description
Memograph M graphic data manager	<p>The Memograph M graphic data manager provides information on all the relevant measured variables. Measured values are recorded correctly, limit values are monitored and measuring points analyzed. The data are stored in the 256 MB internal memory and also on a SD card or USB stick.</p> <ul style="list-style-type: none"><li data-bbox="770 450 1145 477">■ Technical Information TI00133R<li data-bbox="770 477 1155 499">■ Operating Instructions BA00247R

16 Technical data

16.1 Application

Depending on the version ordered, the measuring device can also measure potentially explosive, flammable, poisonous and oxidizing media.

To ensure that the device remains in proper operating condition for its service life, use the measuring device only for media against which the process-wetted materials are sufficiently resistant.

16.2 Function and system design

Measuring principle Proline Prosonic Flow uses a measurement method based on the transit time difference.

Measuring system The device consists of a transmitter and a sensor.
 The device is available as a compact version:
 The transmitter and sensor form a mechanical unit.
 For information on the structure of the device →  11

16.3 Input

Measured variable **Direct measured variables**

- Flow velocity
- Medium temperature
- Sound velocity

Calculated measured variables

- Volume flow
- Mass flow

Measuring range Typically $v = 0$ to 5 m/s (0 to 16.4 ft/s) with the specified accuracy

Flow characteristic values in SI units

Nominal diameter		Recommended flow			Factory settings	Low flow cut off ($v \sim 0.1$ m/s)
[mm]	[in]	$q_i^{1)}$ [m ³ /h]	$q_p^{2)}$ [m ³ /h]	$q_s^{3)}$ [m ³ /h]	Pulse value [dm ³ /pulse]	[dm ³ /min]
50	2	0.15	15	30	3	0
65	2 ½	0.25	25	50	4	0
80	3	0.40	40	80	6	0

Nominal diameter		Recommended flow			Factory settings	Low flow cut off (v ~ 0.1 m/s)
[mm]	[in]	q _i ¹⁾ [m ³ /h]	q _p ²⁾ [m ³ /h]	q _s ³⁾ [m ³ /h]	Pulse value [dm ³ /pulse]	[dm ³ /min]
100	4	0.60	60	120	10	0
150	6	1.50	150	300	25	0

- 1) q_i: Minimum flow rate = Lowest flow rate at which the flowmeter operates within the limits of error in legal metrology
- 2) q_p: Permanent flow rate = Highest flow rate at which the flowmeter operates within the limits of error in legal metrology
- 3) q_s: Maximum flow rate = Highest flow rate

Flow characteristic values in US units

Nominal diameter		Recommended flow			Factory settings	Low flow cut off (v ~ 0.1 m/s)
[in]	[mm]	q _i [gal/min]	q _p [gal/min]	q _s [gal/min]	Pulse value [gal/pulse]	[gal/min]
2	50	0.66	66	132	0.8	0
2 ½	65	1.10	110	220	1.1	0
3	80	1.76	176	352	1.6	0
4	100	2.64	264	528	2.6	0
6	150	6.60	660	1320	6.6	0

Recommended measuring range

"Flow limit" section → 66

 For custody transfer, the applicable approval determines the permitted measuring range, the pulse value and the low flow cut off.

Operable flow range ≥ 200:1

 The operable flow range is q_p/q_i = 100:1 in custody transfer mode.

16.4 Output

Output signal **Pulse output**

Custody transfer version (order code for "Output", option P "Pulse output")

Function	Available as pulse output
Version	Passive, open collector in accordance with EN 1434-2 Class OB and Class OC
Maximum input values	<ul style="list-style-type: none"> ■ DC30 V ■ 25 mA
Voltage drop	For 25 mA: ≤ DC 2 V
Pulse output	
Pulse width	Adjustable: 0.05 to 2 000 ms
Maximum pulse rate	10 000 Impulse/s

Pulse value	Preset (see measuring range → 60)  Cannot be edited in the case of "Custody transfer approval" order code, option AB, AC, CA or DA
Assignable measured variables	Volume flow

 Write-protected in custody transfer mode.

Pulse/frequency output

Non-custody transfer version (order code for "Output", option K "Pulse/frequency output")

Function	Can be configured either for pulse or frequency output
Version	Passive, open collector
Maximum input values	<ul style="list-style-type: none"> ▪ DC30 V ▪ 25 mA
Voltage drop	For 25 mA: ≤ DC 2 V
Pulse output	
Pulse width	Adjustable: 0.05 to 2 000 ms
Maximum pulse rate	10 000 Impulse/s
Pulse value	Adjustable
Assignable measured variables	<ul style="list-style-type: none"> ▪ Volume flow ▪ Mass flow
Frequency output	
Output frequency	Adjustable: 0 to 10 000 Hz
Damping	Adjustable: 0 to 999 s
Pulse/pause ratio	1:1
Assignable measured variables	<ul style="list-style-type: none"> ▪ Volume flow ▪ Mass flow ▪ Sound velocity ▪ Flow velocity ▪ Temperature

Signal on alarm

Depending on the interface, failure information is displayed as follows.

Pulse output

Custody transfer version (order code for "Output", option P "Pulse output")

Pulse output	
Failure mode	No pulses

Pulse/frequency output

Non-custody transfer version (order code for "Output", option K "Pulse/frequency output")

Pulse output	
Failure mode	Choose from: <ul style="list-style-type: none"> ▪ Actual value ▪ No pulses



Frequency output	
Failure mode	Choose from: <ul style="list-style-type: none"> ▪ Actual value ▪ 0 Hz ▪ Defined value: 0 to 12 500 Hz

Interface/protocol

Via service interface CDI-RJ45

 Write-protected in custody transfer mode.

Light emitting diodes (LED)

Status information	Status indicated by various light emitting diodes The following information is displayed depending on the device version: <ul style="list-style-type: none"> ▪ Supply voltage active ▪ Device alarm/error has occurred  Diagnostic information via light emitting diodes →  45
--------------------	---

Low flow cut off The switch points for low flow cut off are user-selectable.

Galvanic isolation The following connections are galvanically isolated from each other:

- Outputs
- Power supply

16.5 Power supply

Terminal assignment →  22

Supply voltage

Transmitter

- Pulse output (order code for "Output", option **P**): DC 12 to 42 V
- Pulse/frequency output (order code for "Output", option **K**): DC 12 to 42 V

Power consumption

Transmitter

Order code for "Output"	Maximum power consumption
Option P : Pulse output	2.0 W
Option K : Pulse/frequency output	2.0 W

Current consumption

Transmitter

Order code for "Output"	Maximum current consumption	Maximum switch-on current
Option P : Pulse output	200 mA	30 A (< 0.2 ms)
Option K : Pulse/frequency output	200 mA	30 A (< 0.2 ms)

Power supply failure Depending on the device version, the configuration is retained in the device memory.

Electrical connection → 24

Potential equalization → 25

Terminals **Transmitter**
Spring terminals for wire cross-sections: 0.5 to 2.5 mm² (20 to 14 AWG)

Cable entries

- Cable gland: M20 × 1.5 with cable Ø 6 to 12 mm (0.24 to 0.47 in)
- Thread for cable entry:
 - M20
 - G ½"
 - NPT ½"

Cable specification → 21

16.6 Performance characteristics

reference operating conditions

- Error limits following DIN EN 29104, in future ISO 20456
- Water with +15 to +45 °C (+59 to +113 °F) at 2 to 6 bar (29 to 87 psi)
- Data as indicated in the calibration protocol
- Accuracy based on accredited calibration rigs according to ISO 17025

Maximum measured error **Error limits under reference operating conditions**

q_i = Minimum flow rate; q_p = Permanent flow rate; q_s = Maximum flow rate

Volume flow

Measured error in accordance with MI-004 Class 2 [%]: $\pm(2 + 0.02 * q_p/q)$, limited to $\pm 5\%$, where q_p represents the permanent flow rate specified in the Section "Measuring ranges" (→ 60) that depends on the nominal diameter, and q represents the current flow rate.

- Fluctuations in the supply voltage do not have any effect within the specified range.
- Temperature accuracy: $\pm 2\text{ °C}$ ($\pm 3.8\text{ °F}$)

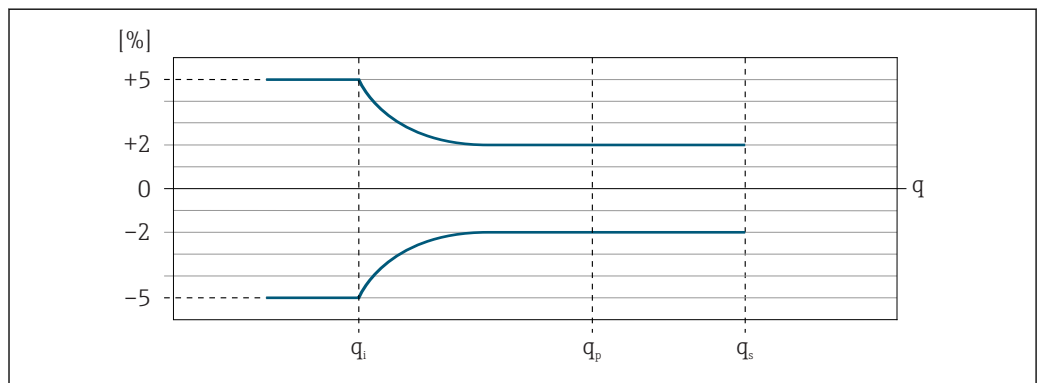

10 Error curve in accordance with MI-004 Class 2

Accuracy of outputs

The outputs have the following base accuracy specifications.

Pulse/frequency output

o.r. = of reading

Accuracy	Max. ±50 ppm o.r. (over the entire ambient temperature range)
-----------------	---

Repeatability o.r. = of reading

Volume flow

±0.1 % o.r.

Influence of ambient temperature **Pulse/frequency output**

Temperature coefficient	No additional effect. Included in accuracy.
--------------------------------	---

16.7 Installation

"Mounting requirements" →  16

16.8 Environment

Ambient temperature range	Transmitter	-25 to +55 °C (-13 to +131 °F) as per EN 1434 environmental class B
	Sensor	-25 to +55 °C (-13 to +131 °F) as per EN 1434 environmental class B

- ▶ If operating outdoors:
Avoid direct sunlight, particularly in warm climatic regions.

Storage temperature All components:
-50 to +80 °C (-58 to +176 °F), preferably at +20 °C (+68 °F)

Degree of protection **Transmitter and sensor**

- As standard: IP66/67, type 4X enclosure
- When housing is open: IP20, type 1 enclosure

Shock resistance Shock due to rough handling following IEC 60068-2-31 as per EN 1434 Mechanical environmental class M2

Vibration resistance

- Oscillation, sinusoidal, following IEC 60068-2-6 as per EN 1434 Mechanical environmental class M2
 - 2 to 8.4 Hz, 3.5 mm peak
 - 8.4 to 500 Hz, 1 g peak
- Oscillation, broadband noise following IEC 60068-2-64 as per EN 1434 Mechanical environmental class M2
 - 10 to 200 Hz, 0.003 g²/Hz
 - 200 to 2 000 Hz, 0.001 g²/Hz
 - Total: 1.54 g rms

Electromagnetic compatibility (EMC)

- As per IEC/EN 61326-1, IEC/EN 61326-2-3 and NAMUR Recommendation 21 (NE 21)
- Complies with emission limits for industry as per EN 55011 (Class A)
- Electromagnetic environmental class as per EN 1434 environmental class B

 Details are provided in the Declaration of Conformity.

16.9 Process

Medium temperature range

Sensor

+0 to +150 °C (+32 to +302 °F)

Pressure-temperature ratings

 An overview of the pressure-temperature ratings for the process connections is provided in the "Technical Information" document

Flow limit

Select the nominal diameter by optimizing between the required flow range and permissible pressure loss.

 For an overview of the full scale values for the measuring range, see the "Measuring range" section →  60

- The minimum recommended full scale value is approx. 1/20 of the maximum full scale value.
- In most applications, 10 to 50 % of the maximum full scale value can be considered ideal.

Pressure loss

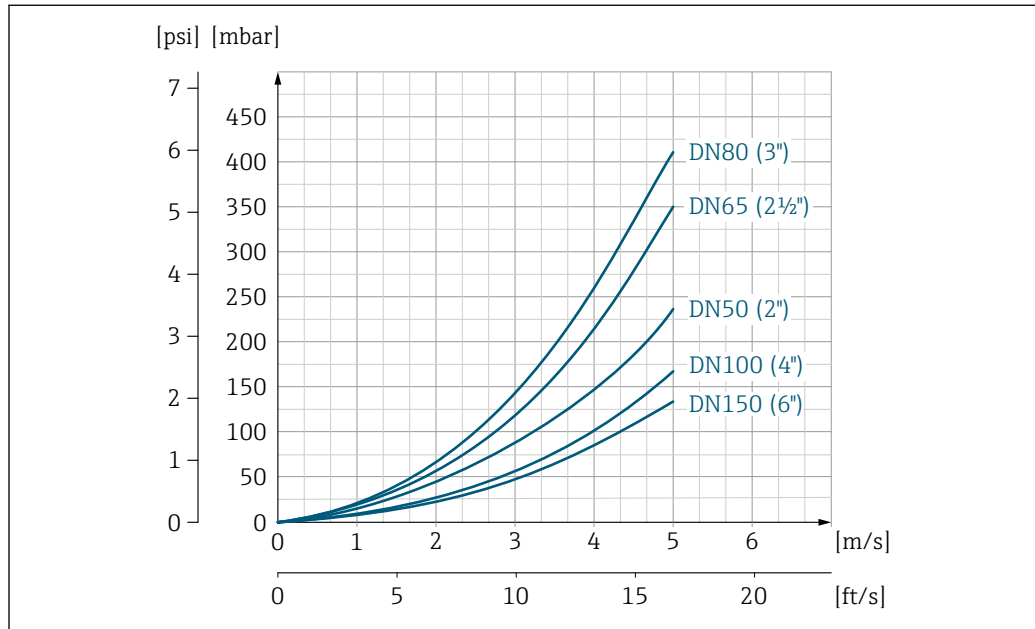

 11 Pressure loss DN 50 to 150 (2 to 6")

 The maximum pressure loss at permanent flow rate q_p is less than the permitted 250 mbar for all nominal diameters in accordance with EN 1434-1.

To calculate the pressure loss, use the *Applicator* sizing tool →  58

System pressure

It is important that cavitation does not occur, or that gases entrained in the liquids do not outgas.

Cavitation is caused if the pressure drops below the vapor pressure:
In suction lines

- ▶ Ensure the system pressure is sufficiently high to prevent cavitation and outgassing.

For this reason, the following mounting locations are recommended:

- At the lowest point in a vertical pipe
- Downstream from pumps (no danger of vacuum)

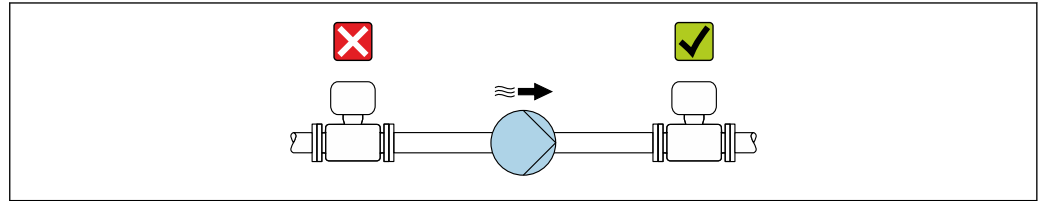

A0028777

Thermal insulation

In the case of some fluids, it is important to keep the heat radiated from the sensor to the transmitter to a low level. A wide range of materials can be used for the required insulation.

NOTICE

Electronics overheating on account of thermal insulation!

- ▶ Observe maximum permitted insulation height of the transmitter neck so that the transmitter head is completely free.

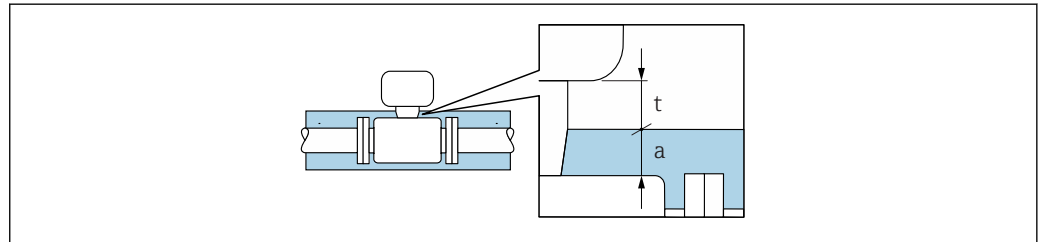

A0034104

t Maximum insulation thickness 2 cm (0.79 in)

a Minimum distance from transmitter to insulation

16.10 Mechanical construction

Design, dimensions



For the dimensions and installation lengths of the device, see the "Technical Information" document, "Mechanical construction" section.

Weight

Weight in SI units

Compact version

Order code for "Housing", option A "Compact, aluminum, coated"

Nominal diameter [mm]	Version	Fixed flange		Lap joint flange		Lap joint flange, stamped plate EN 1092-1 (DIN 2501) ⁴⁾ [kg]
		EN 1092-1 (DIN 2501) ¹⁾ [kg]	ASME B16.5 ²⁾ [kg]	EN 1092-1 (DIN 2501) ³⁾ [kg]	ASME B16.5 ²⁾ [kg]	
50	Single-path	9.15	8.00	8.90	8.10	7.20
65	Single-path	10.8	-	10.7	-	8.10
80	Single-path	12.2	12.8	12.2	12.9	8.80

Nominal diameter [mm]	Version	Fixed flange		Lap joint flange		Lap joint flange, stamped plate
		EN 1092-1 (DIN 2501) ¹⁾ [kg]	ASME B16.5 ²⁾ [kg]	EN 1092-1 (DIN 2501) ³⁾ [kg]	ASME B16.5 ²⁾ [kg]	EN 1092-1 (DIN 2501) ⁴⁾ [kg]
100	Single-path	16.0	18.0	15.8	18.0	11.1
100	Two-path	16.1	18.1	16.0	17.9	11.2
150	Single-path	25.6	26.6	22.2	26.7	17.7
150	Two-path	25.4	26.4	22.0	26.2	17.5

1) Pressure rating PN 40 (DN 50), PN 16 (DN 65 to 150)

2) Pressure rating, class 150

3) Pressure rating PN 10/16

4) Pressure rating PN 10

Weight in US units

Compact version

Order code for "Housing", option A "Compact, aluminum, coated"

Nominal diameter [in]	Version	Fixed flange ASME B16.5 ¹⁾ [lbs]	Lap joint flange ASME B16.5 ¹⁾ [lbs]
2	Single-path	17.6	17.9
3	Single-path	28.2	28.5
4	Single-path	39.7	39.7
4	Two-path	39.9	39.5
6	Single-path	58.7	58.9
6	Two-path	58.2	57.7

1) Pressure rating, class 150

Materials

Transmitter housing

- Order code for "Housing", option **A** "Compact, aluminum coated": Aluminum, AlSi10Mg, coated
- Window material for optional LED display: Order code for "Housing", option **B**: glass

Cable entries/cable glands

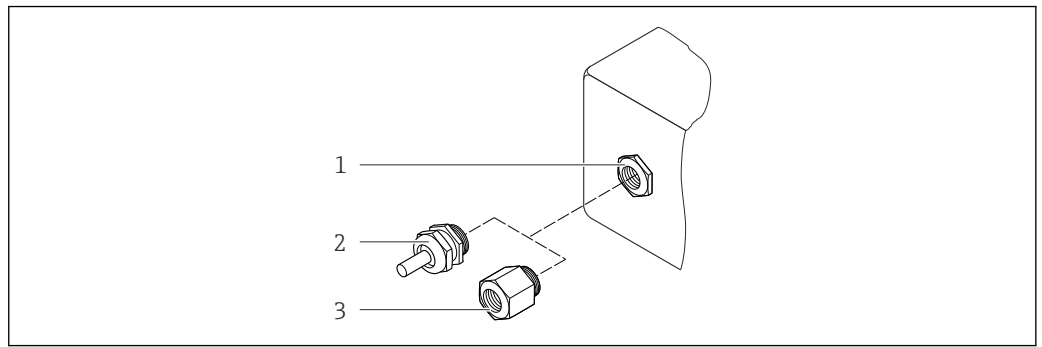

A0020640

12 Possible cable entries/cable glands

- 1 Female thread M20 × 1.5
- 2 Cable gland M20 × 1.5
- 3 Adapter for cable entry with internal thread G ½" or NPT ½"

Order code for "Housing", option A "Compact, aluminum, coated"

Cable entry/cable gland	Material
Cable gland M20 × 1.5	Nickel-plated brass
Adapter for cable entry with internal thread G ½"	
Adapter for cable entry with internal thread NPT ½"	

Sensor housing

Stainless steel (cold worked):

- 1.4404 (316L)
- 1.4435 (316L)

Process connections

- Stainless steel:
 - 1.4301 (304)
 - 1.4306 (304L)
 - 1.4404 (316L)
 - 1.4571 (316Ti)
- Steel S235JR (1.0038)
- Carbon steel A105

List of all available process connections → 69

Process connections

Flanges:

- EN 1092-1 (DIN 2501)
- ASME B16.5

For information on the different materials used in the process connections → 69

16.11 Operability

Service interface

Using service interface via FXA291 and service adapter

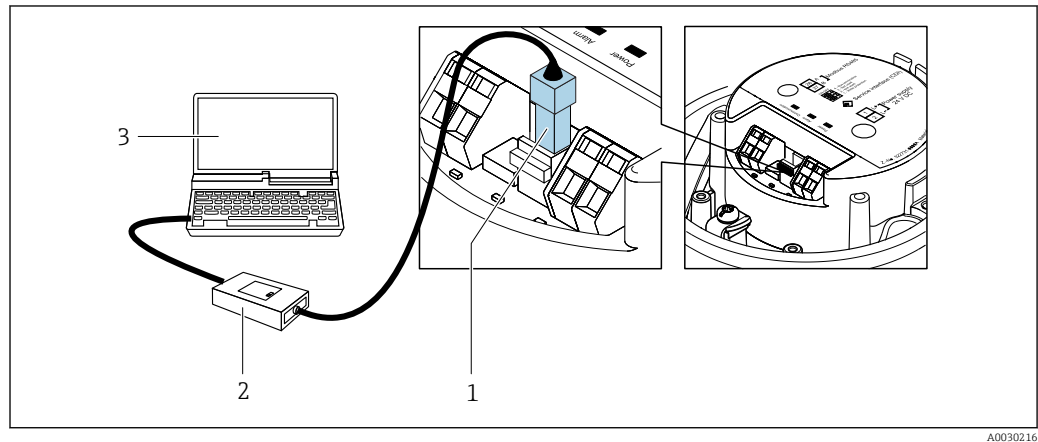

- 1 Service interface (CDI) of measuring device
 2 Commubox FXA291
 3 Computer with "FieldCare" operating tool with "CDI Communication FXA291" COM DTM

Languages

Can be operated in the following languages:
 Via "FieldCare" operating tool: English, German, French, Spanish, Italian, Chinese, Japanese

16.12 Certificates and approvals

CE mark

The measuring system is in conformity with the statutory requirements of the applicable EU Directives. These are listed in the corresponding EU Declaration of Conformity along with the standards applied.

Endress+Hauser confirms successful testing of the device by affixing to it the CE mark.

C-Tick symbol

The measuring system meets the EMC requirements of the "Australian Communications and Media Authority (ACMA)".

Pressure Equipment Directive

- With the identification PED/G1/x (x = category) on the sensor nameplate, Endress+Hauser confirms conformity with the "Essential Safety Requirements" specified in Appendix I of the Pressure Equipment Directive 2014/68/EC.
- Devices not bearing this marking (PED) are designed and manufactured according to good engineering practice. They meet the requirements of Art. 4, Par. 3 of the Pressure Equipment Directive 2014/68/EU. The range of application is indicated in tables 6 to 9 in Annex II of the Pressure Equipment Directive 2014/68/EC.

Other standards and guidelines

- EN 60529
Degrees of protection provided by enclosures (IP code)
- EN 61010-1
Safety requirements for electrical equipment for measurement, control and laboratory use - general requirements
- IEC/EN 61326
Emission in accordance with Class A requirements. Electromagnetic compatibility (EMC requirements).
- 2014/32/EU
Measuring Instruments Directive, MI-004 Heat counters



- EN 1434/OIML R75 Heat counters
- TR K7.2 Standard on metrological testing of cooling meters
- NAMUR NE 21
Electromagnetic compatibility (EMC) of industrial process and laboratory control equipment
- NAMUR NE 32
Data retention in the event of a power failure in field and control instruments with microprocessors
- NAMUR NE 43
Standardization of the signal level for the breakdown information of digital transmitters with analog output signal.
- NAMUR NE 53
Software of field devices and signal-processing devices with digital electronics
- NAMUR NE 80
The application of the pressure equipment directive to process control devices
- NAMUR NE 105
Specifications for integrating fieldbus devices in engineering tools for field devices
- NAMUR NE 107
Self-monitoring and diagnosis of field devices
- NAMUR NE 131
Requirements for field devices for standard applications

16.13 Application packages

Many different application packages are available to enhance the functionality of the device. Such packages might be needed to address safety aspects or specific application requirements.

The application packages can be ordered with the device or subsequently from Endress+Hauser. Detailed information on the order code in question is available from your local Endress+Hauser sales center or on the product page of the Endress+Hauser website: www.endress.com.

16.14 Accessories

 Overview of accessories available for order →  58

16.15 Supplementary documentation

 For an overview of the scope of the associated Technical Documentation, refer to the following:

- The *W@M Device Viewer* : Enter the serial number from the nameplate (www.endress.com/deviceviewer)
- The *Endress+Hauser Operations App*: Enter the serial number from the nameplate or scan the 2-D matrix code (QR code) on the nameplate.

Standard documentation

Brief Operating Instructions

Brief Operating Instructions for the sensor

Measuring device	Documentation code
Proline Prosonic Flow E	KA01329D

Brief Operating Instructions for transmitter

Measuring device	Documentation code
Heat	KA01353D

Technical Information

Measuring device	Documentation code
Prosonic Flow E Heat	TI01360D

Description of Device Parameters

Measuring device	Documentation code
Prosonic Flow Heat	GP01125D

Supplementary device-dependent documentation

Special documentation

Contents	Documentation code
Information on the Pressure Equipment Directive	SD01614D
RFID TAG	SD01565D

Installation Instructions

Contents	Comment
Installation instructions for spare part sets and accessories	<ul style="list-style-type: none"> ▪ Access the overview of all the available spare part sets via <i>W@MDevice Viewer</i> → 📖 56 ▪ Accessories available for order with Installation Instructions → 📖 58

Index

A

- Adapting the diagnostic behavior 47
- Ambient temperature
 - Influence 65
- Ambient temperature range 18, 65
- Application 60
- Application packages 71
- Applicator 60
- Approvals 70

C

- C-Tick symbol 70
- Cable entries
 - Technical data 64
- Cable entry
 - Degree of protection 25
- CE mark 9, 70
- Certificates 70
- Check
 - Post-mounting 20
- Checklist
 - Post-connection check 26
 - Post-mounting check 20
- Cleaning
 - Exterior cleaning 55
- Commissioning 30
 - Advanced settings 37
 - Configuring the measuring device 30
- Connecting cable 21
- Connecting the measuring device 24
- Connection
 - see Electrical connection
- Connection preparations 23
- Connection tools 21
- Current consumption 63

D

- Declaration of Conformity 9
- Degree of protection 25, 65
- Design
 - Measuring device 11
- Designated use 8
- Device components 11
- Device description files 29
- Device documentation
 - Supplementary documentation 7
- Device locking, status 41
- Device name
 - Sensor 14
 - Transmitter 13
- Device repair 56
- Device revision 29
- Device type ID 29
- DeviceCare 27
 - Device description file 29

Diagnostic information

- Design, description 46
- DeviceCare 45
- FieldCare 45
- Light emitting diodes 45
- Overview 47
- Remedial measures 47
- Diagnostic list 50
- Display values
 - For locking status 41
- Disposal 57
- Document
 - Function 5
 - Symbols used 5
- Document function 5

E

- Electrical connection
 - Commubox FXA291 27, 70
 - Degree of protection 25
 - Measuring device 21
 - Operating tools
 - Via FXA291 and service adapter 70
 - Via service interface (CDI) 27
- Electromagnetic compatibility 66
- Endress+Hauser services
 - Maintenance 55
 - Repair 56
- Environment
 - Shock resistance 65
 - Storage temperature 65
 - Vibration resistance 65
- Error messages
 - see Diagnostic messages
- Event list 50
- Event logbook 50
- Extended order code
 - Sensor 14
 - Transmitter 13
- Exterior cleaning 55

F

- Field of application
 - Residual risks 9
- FieldCare
 - Device description file 29
- Filtering the event logbook 51
- Firmware
 - Release date 29
 - Version 29
- Firmware history 54
- Flow direction 17, 19
- Flow limit 66
- Function check 30
- Functions
 - see Parameter

G

Galvanic isolation 63

I

I/O electronics module 11, 24

Identifying the measuring device 12

Incoming acceptance 12

Influence

Ambient temperature 65

Information on the document 5

Inlet runs 17

Input 60

Inspection

Received goods 12

Inspection check

Connection 26

Installation 16

Installation conditions

Inlet and outlet runs 17

Installation dimensions 18

Mounting location 16

Orientation 17

System pressure 18, 66

Thermal insulation 18, 67

Installation dimensions 18

L

Languages, operation options 70

Low flow cut off 63

M

Main electronics module 11

Maintenance 55

Maintenance tasks 55

Manufacturer ID 29

Manufacturing date 13, 14

Materials 68

Maximum measured error 64

Measured values

Calculated 60

Direct 60

see Process variables

Measuring and test equipment 55

Measuring device

Configuration 30

Conversion 56

Design 11

Disposal 57

Integrating via HART protocol 29

Mounting the sensor 19

Preparing for electrical connection 23

Preparing for mounting 19

Removing 57

Repairs 56

Measuring principle 60

Measuring range 60

Measuring range, recommended 66

Measuring system 60

Menu

Diagnostics 49

Operation 41

Setup 30

Menus

For measuring device configuration 30

For specific settings 37

Mounting dimensions

see Installation dimensions

Mounting location 16

Mounting preparations 19

Mounting tools 19

N

Nameplate

Sensor 14

Transmitter 13

O

Operable flow range 61

Operation 41

Operation options 27

Operational safety 9

Order code 12, 13, 14

Orientation (vertical, horizontal) 17

Outlet runs 17

Output 61

Output signal 61

P

Packaging disposal 16

Parameter settings

Administration (Submenu) 38

Advanced setup (Submenu) 37

Device information (Submenu) 52

Diagnostics (Menu) 49

Low flow cut off (Submenu) 35

Process variables (Submenu) 41

Pulse/frequency/switch output 1 (Submenu) 33

Sensor adjustment (Submenu) 37

Setup (Menu) 30

Simulation (Submenu) 39

System units (Submenu) 30

System values (Submenu) 42

Totalizer (Submenu) 43

Totalizer 1 to n (Submenu) 37

Totalizer handling (Submenu) 43

Performance characteristics 64

Post-connection check (checklist) 26

Post-installation check 30

Post-mounting check (checklist) 20

Potential equalization 25

Power consumption 63

Power supply failure 63

Pressure Equipment Directive 70

Pressure loss 66

Pressure-temperature ratings 66

Process connections 69

Product safety 9

- R**
- Reading measured values 41
 - Recalibration 55
 - reference operating conditions 64
 - Registered trademarks 7
 - Repair of a device 56
 - Repairs 56
 - Notes 56
 - Repeatability 65
 - Replacement
 - Device components 56
 - Requirements for personnel 8
 - Return 56
- S**
- Safety 8
 - Sensor
 - Medium temperature range 66
 - Mounting 19
 - Serial number 13, 14
 - Settings
 - Adapting the measuring device to the process conditions 43
 - Administration 38
 - Device reset 52
 - Device tag 30
 - Low flow cut off 35
 - Pulse output 33
 - Pulse/frequency output 32
 - Pulse/frequency/switch output 33
 - Resetting the totalizer 43
 - Sensor adjustment 37
 - Simulation 39
 - System units 30
 - Totalizer 37
 - Totalizer reset 43
 - Shock resistance 65
 - Signal on alarm 62
 - Software release 29
 - Spare part 56
 - Spare parts 56
 - Special connection instructions 25
 - Standards and guidelines 70
 - Storage conditions 15
 - Storage temperature 15
 - Storage temperature range 65
 - Submenu
 - Administration 38
 - Advanced setup 37
 - Device information 52
 - Event list 50
 - Low flow cut off 35
 - Process variables 41
 - Pulse/frequency/switch output 1 32, 33
 - Sensor adjustment 37
 - Simulation 39
 - System units 30
 - System values 42
 - Totalizer 43
 - Totalizer 1 to n 37
 - Totalizer handling 43
 - Supplementary documentation 71
 - Supply voltage 63
 - System design
 - Measuring system 60
 - see Measuring device design
 - System integration 29
 - System pressure 18, 66
- T**
- Technical data, overview 60
 - Temperature range
 - Ambient temperature 18, 65
 - Medium temperature 66
 - Storage temperature 15
 - Terminal assignment 22, 24
 - Terminals 64
 - Thermal insulation 18, 67
 - Tools
 - Electrical connection 21
 - For mounting 19
 - Transport 15
 - Transmitter
 - Connecting the signal cables 24
 - Transporting the measuring device 15
 - Troubleshooting
 - General 45
- U**
- Use of the measuring device
 - Borderline cases 8
 - Incorrect use 8
 - see Designated use
 - User interface
 - Current diagnostic event 49
 - Previous diagnostic event 49
- V**
- Version data for the device 29
 - Vibration resistance 65
- W**
- W@M 55, 56
 - W@M Device Viewer 12, 56
 - Weight
 - SI units 67
 - Transport (notes) 15
 - US units 68
 - Wizard
 - Low flow cut off 35
 - Workplace safety 9

www.addresses.endress.com
