

# Operating Instructions

## Proline Prowirl C 200

### PROFIBUS PA

Vortex flowmeter

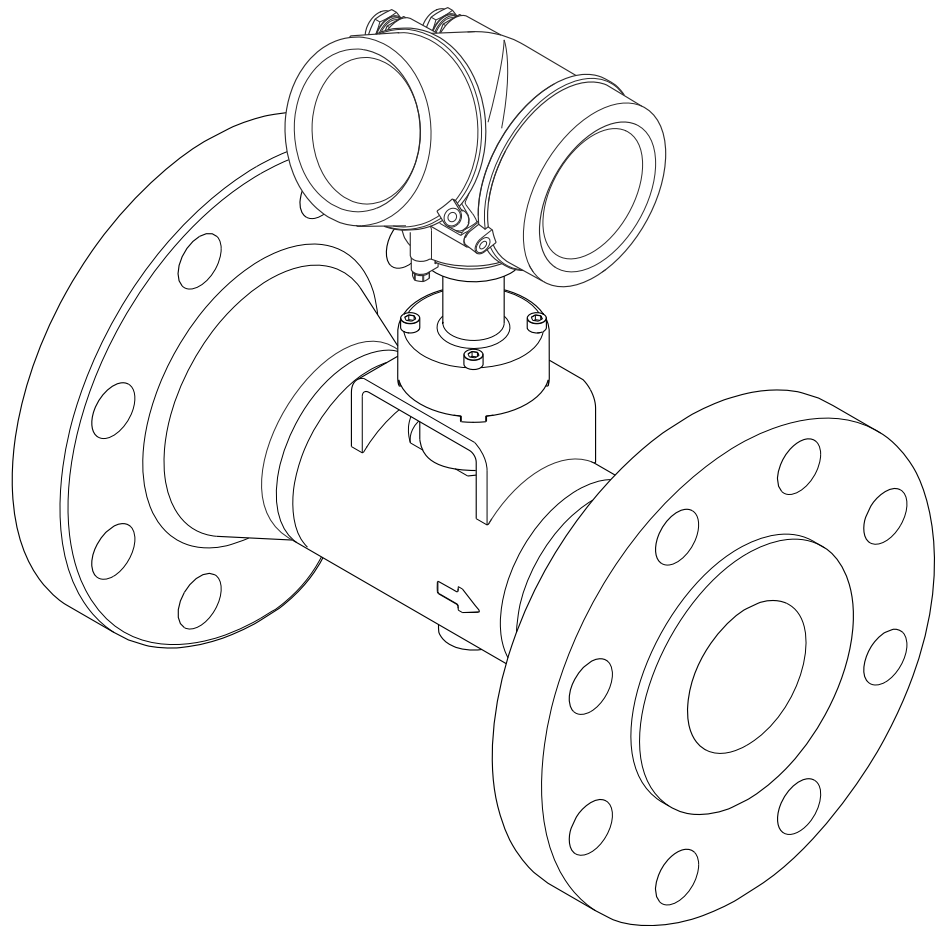

- Make sure the document is stored in a safe place such that it is always available when working on or with the device.
- To avoid danger to individuals or the facility, read the "Basic safety instructions" section carefully, as well as all other safety instructions in the document that are specific to working procedures.
- The manufacturer reserves the right to modify technical data without prior notice. Your Endress+Hauser Sales Center will supply you with current information and updates to these instructions.

## Table of contents

<b>1</b>	<b>Document information</b>	<b>6</b>		
1.1	Document function	6		
1.2	Symbols used	6		
1.2.1	Safety symbols	6		
1.2.2	Electrical symbols	6		
1.2.3	Tool symbols	6		
1.2.4	Symbols for certain types of information	7		
1.2.5	Symbols in graphics	7		
1.3	Documentation	7		
1.3.1	Standard documentation	8		
1.3.2	Supplementary device-dependent documentation	8		
1.4	Registered trademarks	8		
<b>2</b>	<b>Basic safety instructions</b>	<b>9</b>		
2.1	Requirements for the personnel	9		
2.2	Designated use	9		
2.3	Workplace safety	10		
2.4	Operational safety	10		
2.5	Product safety	10		
2.6	IT security	10		
<b>3</b>	<b>Product description</b>	<b>11</b>		
3.1	Product design	11		
<b>4</b>	<b>Incoming acceptance and product identification</b>	<b>12</b>		
4.1	Incoming acceptance	12		
4.2	Product identification	12		
4.2.1	Transmitter nameplate	13		
4.2.2	Sensor nameplate	14		
4.2.3	Symbols on measuring device	16		
<b>5</b>	<b>Storage and transport</b>	<b>17</b>		
5.1	Storage conditions	17		
5.2	Transporting the product	17		
5.2.1	Measuring devices without lifting lugs	17		
5.2.2	Measuring devices with lifting lugs	18		
5.2.3	Transporting with a fork lift	18		
5.3	Packaging disposal	18		
<b>6</b>	<b>Installation</b>	<b>19</b>		
6.1	Installation conditions	19		
6.1.1	Mounting position	19		
6.1.2	Requirements from environment and process	22		
6.1.3	Special mounting instructions	23		
6.2	Mounting the measuring device	24		
6.2.1	Required tools	24		
6.2.2	Preparing the measuring device	24		
6.2.3	Mounting the sensor	25		
6.2.4	Mounting the transmitter of the remote version	25		
6.2.5	Turning the transmitter housing	26		
6.2.6	Turning the display module	27		
6.3	Post-installation check	27		
<b>7</b>	<b>Electrical connection</b>	<b>29</b>		
7.1	Connection conditions	29		
7.1.1	Required tools	29		
7.1.2	Connecting cable requirements	29		
7.1.3	Terminal assignment	32		
7.1.4	Pin assignment, device plug	33		
7.1.5	Shielding and grounding	33		
7.1.6	Requirements for the supply unit	34		
7.1.7	Preparing the measuring device	35		
7.2	Connecting the measuring device	35		
7.2.1	Connecting the remote version	35		
7.2.2	Connecting the transmitter	39		
7.2.3	Ensuring potential equalization	41		
7.3	Special connection instructions	41		
7.3.1	Connection examples	41		
7.4	Hardware settings	42		
7.4.1	Setting the device address	42		
7.5	Ensuring the degree of protection	43		
7.6	Post-connection check	44		
<b>8</b>	<b>Operation options</b>	<b>45</b>		
8.1	Overview of operating options	45		
8.2	Structure and function of the operating menu	46		
8.2.1	Structure of the operating menu	46		
8.2.2	Operating philosophy	47		
8.3	Access to the operating menu via the local display	48		
8.3.1	Operational display	48		
8.3.2	Navigation view	49		
8.3.3	Editing view	51		
8.3.4	Operating elements	52		
8.3.5	Opening the context menu	53		
8.3.6	Navigating and selecting from list	55		
8.3.7	Calling the parameter directly	55		
8.3.8	Calling up help text	56		
8.3.9	Changing the parameters	57		
8.3.10	User roles and related access authorization	58		
8.3.11	Disabling write protection via access code	58		
8.3.12	Enabling and disabling the keypad lock	58		
8.4	Access to the operating menu via the operating tool	59		
8.4.1	Connecting the operating tool	59		

8.4.2	FieldCare .....	61	11.4.3	Output values .....	131
8.4.3	SIMATIC PDM .....	62	11.5	Adapting the measuring device to the process conditions .....	131
<b>9</b>	<b>System integration .....</b>	<b>63</b>	11.6	Performing a totalizer reset .....	131
9.1	Overview of device description files .....	63	11.7	Showing data logging .....	132
9.1.1	Current version data for the device ...	63	<b>12</b>	<b>Diagnostics and troubleshooting ..</b>	<b>135</b>
9.1.2	Operating tools .....	63	12.1	General troubleshooting .....	135
9.2	Device master file (GSD) .....	63	12.2	Diagnostic information on local display .....	137
9.2.1	Manufacturer-specific GSD .....	64	12.2.1	Diagnostic message .....	137
9.2.2	Profile GSD .....	64	12.2.2	Calling up remedial measures .....	139
9.2.3	Compatibility with other Endress +Hauser measuring devices .....	64	12.3	Diagnostic information in FieldCare .....	139
9.3	Cyclic data transmission .....	65	12.3.1	Diagnostic options .....	139
9.3.1	Block model .....	65	12.3.2	Calling up remedy information .....	140
9.3.2	Description of the modules .....	66	12.4	Adapting the diagnostic information .....	141
<b>10</b>	<b>Commissioning .....</b>	<b>72</b>	12.4.1	Adapting the measured value and device status .....	141
10.1	Function check .....	72	12.4.2	Adapting the diagnostic behavior ...	142
10.2	Switching on the measuring device .....	72	12.5	Overview of diagnostic information .....	145
10.3	Configuring the device address via software ..	72	12.5.1	Diagnostic of sensor .....	145
10.3.1	PROFIBUS network .....	72	12.5.2	Diagnostic of electronic .....	148
10.4	Setting the operating language .....	72	12.5.3	Diagnostic of configuration .....	155
10.5	Configuring the measuring device .....	74	12.5.4	Diagnostic of process .....	162
10.5.1	Defining the tag name .....	74	12.6	Pending diagnostic events .....	170
10.5.2	Selecting and setting the medium ...	76	12.7	Diagnostic list .....	171
10.5.3	Setting the system units .....	78	12.8	Event logbook .....	171
10.5.4	Configuring the analog inputs .....	81	12.8.1	Event history .....	171
10.5.5	Configuring the local display .....	82	12.8.2	Filtering the event logbook .....	171
10.5.6	Configuring communication interface .....	83	12.8.3	Overview of information events .....	172
10.5.7	Configuring the low flow cut off .....	84	12.9	Resetting the measuring device .....	173
10.6	Advanced settings .....	86	12.9.1	Function scope of the "Device reset" parameter .....	173
10.6.1	Setting the medium properties .....	87	12.10	Device information .....	173
10.6.2	Performing external compensation .	101	12.11	Firmware history .....	176
10.6.3	Carrying out a sensor adjustment ...	103	<b>13</b>	<b>Maintenance .....</b>	<b>177</b>
10.6.4	Configuring the pulse/frequency/ switch output .....	104	13.1	Maintenance tasks .....	177
10.6.5	Configuring the totalizer .....	116	13.1.1	Exterior cleaning .....	177
10.6.6	Carrying out additional display configurations .....	118	13.1.2	Interior cleaning .....	177
10.7	Configuration management .....	120	13.1.3	Replacing seals .....	177
10.7.1	Function scope of the "Configuration management" parameter .....	121	13.2	Inspection ports .....	177
10.8	Simulation .....	122	13.3	Measuring and test equipment .....	178
10.9	Protecting settings from unauthorized access .....	124	13.4	Endress+Hauser services .....	178
10.9.1	Write protection via access code ...	124	<b>14</b>	<b>Repair .....</b>	<b>179</b>
10.9.2	Write protection via write protection switch .....	125	14.1	General notes .....	179
<b>11</b>	<b>Operation .....</b>	<b>127</b>	14.2	Spare parts .....	179
11.1	Reading the device locking status .....	127	14.3	Endress+Hauser services .....	180
11.2	Adjusting the operating language .....	127	14.4	Return .....	180
11.3	Configuring the display .....	127	14.5	Disposal .....	180
11.4	Reading measured values .....	127	14.5.1	Removing the measuring device ...	180
11.4.1	Process variables .....	127	14.5.2	Disposing of the measuring device ..	181
11.4.2	Totalizer .....	130	<b>15</b>	<b>Accessories .....</b>	<b>182</b>
			15.1	Device-specific accessories .....	182
			15.1.1	For the transmitter .....	182

---

15.1.2	For the sensor .....	183
15.2	Service-specific accessories .....	183
15.3	System components .....	184
<b>16</b>	<b>Technical data .....</b>	<b>185</b>
16.1	Application .....	185
16.2	Function and system design .....	185
16.3	Input .....	185
16.4	Output .....	191
16.5	Power supply .....	194
16.6	Performance characteristics .....	196
16.7	Installation .....	199
16.8	Environment .....	199
16.9	Process .....	200
16.10	Mechanical construction .....	200
16.11	Operability .....	204
16.12	Certificates and approvals .....	206
16.13	Application packages .....	207
16.14	Accessories .....	207
16.15	Supplementary documentation .....	208
<b>Index</b> .....		<b>209</b>





# 1 Document information

## 1.1 Document function







These Operating Instructions contain all the information that is required in various phases of the life cycle of the device: from product identification, incoming acceptance and storage, to mounting, connection, operation and commissioning through to troubleshooting, maintenance and disposal.

## 1.2 Symbols used



### 1.2.1 Safety symbols

Symbol	Meaning
	<b>DANGER!</b> This symbol alerts you to a dangerous situation. Failure to avoid this situation will result in serious or fatal injury.
	<b>WARNING!</b> This symbol alerts you to a dangerous situation. Failure to avoid this situation can result in serious or fatal injury.
	<b>CAUTION!</b> This symbol alerts you to a dangerous situation. Failure to avoid this situation can result in minor or medium injury.
	<b>NOTE!</b> This symbol contains information on procedures and other facts which do not result in personal injury.





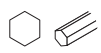





### 1.2.2 Electrical symbols

Symbol	Meaning	Symbol	Meaning
	Direct current		Alternating current
	Direct current and alternating current		<b>Ground connection</b> A grounded terminal which, as far as the operator is concerned, is grounded via a grounding system.
	<b>Protective ground connection</b> A terminal which must be connected to ground prior to establishing any other connections.		<b>Equipotential connection</b> A connection that has to be connected to the plant grounding system: This may be a potential equalization line or a star grounding system depending on national or company codes of practice.





### 1.2.3 Tool symbols

Symbol	Meaning
	Flat blade screwdriver
	Allen key
	Open-ended wrench

### 1.2.4 Symbols for certain types of information

Symbol	Meaning
	<b>Permitted</b> Procedures, processes or actions that are permitted.
	<b>Preferred</b> Procedures, processes or actions that are preferred.
	<b>Forbidden</b> Procedures, processes or actions that are forbidden.
	<b>Tip</b> Indicates additional information.
	Reference to documentation
	Reference to page
	Reference to graphic
	Series of steps
	Result of a step
	Help in the event of a problem
	Visual inspection

### 1.2.5 Symbols in graphics

Symbol	Meaning	Symbol	Meaning
1, 2, 3,...	Item numbers		Series of steps
A, B, C, ...	Views	A-A, B-B, C-C, ...	Sections
	Hazardous area		Safe area (non-hazardous area)
	Flow direction		

## 1.3 Documentation

 For an overview of the scope of the associated Technical Documentation, refer to the following:

- The *W@M Device Viewer* : Enter the serial number from the nameplate ([www.endress.com/deviceviewer](http://www.endress.com/deviceviewer))
- The *Endress+Hauser Operations App*: Enter the serial number from the nameplate or scan the 2-D matrix code (QR code) on the nameplate.

 For a detailed list of the individual documents along with the documentation code

### 1.3.1 Standard documentation

Document type	Purpose and content of the document
Technical Information	<b>Planning aid for your device</b> The document contains all the technical data on the device and provides an overview of the accessories and other products that can be ordered for the device.
Brief Operating Instructions	<b>Guide that takes you quickly to the 1st measured value</b> The Brief Operating Instructions contain all the essential information from incoming acceptance to initial commissioning.

### 1.3.2 Supplementary device-dependent documentation

Additional documents are supplied depending on the device version ordered: Always comply strictly with the instructions in the supplementary documentation. The supplementary documentation is an integral part of the device documentation.

## 1.4 Registered trademarks

### **PROFIBUS®**

Registered trademark of the PROFIBUS User Organization, Karlsruhe, Germany

### **KALREZ®, VITON®**

Registered trademarks of DuPont Performance Elastomers L.L.C., Wilmington, DE USA

### **GYLON®**

Registered trademark of Garlock Sealing Technologies, Palmyra, NY, USA

### **Applicator®, FieldCare®, DeviceCare®, Field Xpert™, HistoROM®, Heartbeat Technology™**

Registered or registration-pending trademarks of the Endress+Hauser Group



## 2 Basic safety instructions

### 2.1 Requirements for the personnel

The personnel for installation, commissioning, diagnostics and maintenance must fulfill the following requirements:

- ▶ Trained, qualified specialists must have a relevant qualification for this specific function and task
- ▶ Are authorized by the plant owner/operator
- ▶ Are familiar with federal/national regulations
- ▶ Before beginning work, the specialist staff must have read and understood the instructions in the Operating Instructions and supplementary documentation as well as in the certificates (depending on the application)
- ▶ Following instructions and basic conditions

The operating personnel must fulfill the following requirements:

- ▶ Being instructed and authorized according to the requirements of the task by the facility's owner-operator
- ▶ Following the instructions in these Operating Instructions

### 2.2 Designated use

#### Application and media

Depending on the version ordered, the measuring device can also measure potentially explosive, flammable, poisonous and oxidizing media.

Measuring devices for use in hazardous areas, in hygienic applications or in applications where there is an increased risk due to process pressure, are labeled accordingly on the nameplate.

To ensure that the measuring device remains in proper condition for the operation time:

- ▶ Only use the measuring device in full compliance with the data on the nameplate and the general conditions listed in the Operating Instructions and supplementary documentation.
- ▶ Check the nameplate to verify if the device ordered can be put to its intended use in the approval-related area (e.g. explosion protection, pressure vessel safety).
- ▶ Use the measuring device only for media against which the process-wetted materials are adequately resistant.
- ▶ If the measuring device is not operated at atmospheric temperature, compliance with the relevant basic conditions specified in the associated device documentation is absolutely essential: "Documentation" section →  7.
- ▶ Protect the measuring device permanently against corrosion from environmental influences.

#### Incorrect use

Non-designated use can compromise safety. The manufacturer is not liable for damage caused by improper or non-designated use.

#### **WARNING**

#### **Danger of breakage of the sensor due to corrosive or abrasive fluids or from environmental conditions!**

- ▶ Verify the compatibility of the process fluid with the sensor material.
- ▶ Ensure the resistance of all fluid-wetted materials in the process.
- ▶ Keep within the specified pressure and temperature range.

Verification for borderline cases:

- ▶ For special fluids and fluids for cleaning, Endress+Hauser is glad to provide assistance in verifying the corrosion resistance of fluid-wetted materials, but does not accept any

warranty or liability as minute changes in the temperature, concentration or level of contamination in the process can alter the corrosion resistance properties.

### **Residual risks**

Possible burn hazard due to fluid temperatures!

- ▶ For elevated fluid temperature, ensure protection against contact to prevent burns.

## **2.3 Workplace safety**

For work on and with the device:

- ▶ Wear the required personal protective equipment according to federal/national regulations.

For welding work on the piping:

- ▶ Do not ground the welding unit via the measuring device.

If working on and with the device with wet hands:

- ▶ It is recommended to wear gloves on account of the higher risk of electric shock.

## **2.4 Operational safety**

Risk of injury.

- ▶ Operate the device in proper technical condition and fail-safe condition only.
- ▶ The operator is responsible for interference-free operation of the device.

### **Conversions to the device**

Unauthorized modifications to the device are not permitted and can lead to unforeseeable dangers.

- ▶ If, despite this, modifications are required, consult with Endress+Hauser.

### **Repair**

To ensure continued operational safety and reliability,

- ▶ Carry out repairs on the device only if they are expressly permitted.
- ▶ Observe federal/national regulations pertaining to repair of an electrical device.
- ▶ Use original spare parts and accessories from Endress+Hauser only.

## **2.5 Product safety**

This measuring device is designed in accordance with good engineering practice to meet state-of-the-art safety requirements, has been tested, and left the factory in a condition in which it is safe to operate.

It meets general safety standards and legal requirements. It also complies with the EC directives listed in the device-specific EC Declaration of Conformity.

## **2.6 IT security**

We only provide a warranty if the device is installed and used as described in the Operating Instructions. The device is equipped with security mechanisms to protect it against any inadvertent changes to the device settings.

IT security measures in line with operators' security standards and designed to provide additional protection for the device and device data transfer must be implemented by the operators themselves.

### 3 Product description

The device consists of a transmitter and a sensor.

Two device versions are available:

- Compact version – transmitter and sensor form a mechanical unit.
- Remote version - transmitter and sensor are mounted in separate locations.

#### 3.1 Product design

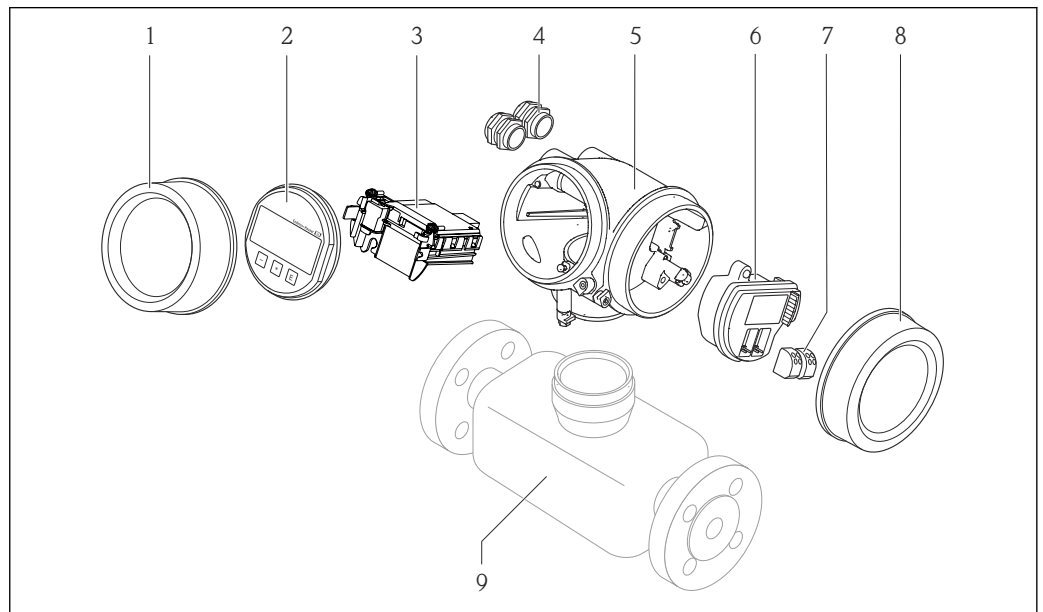













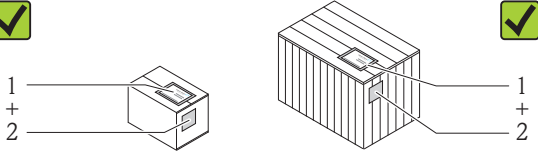

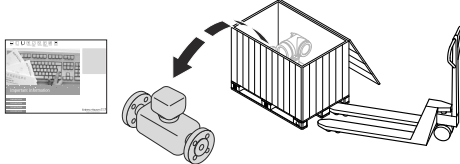
A0020649

#### 1 Important components of a measuring device

- 1 Electronics compartment cover
- 2 Display module
- 3 Main electronics module
- 4 Cable glands
- 5 Transmitter housing (incl. HistoROM)
- 6 I/O electronics module
- 7 Terminals (pluggable spring terminals)
- 8 Connection compartment cover
- 9 Sensor

## 4 Incoming acceptance and product identification

### 4.1 Incoming acceptance

				<p>Are the order codes on the delivery note (1) and the product sticker (2) identical?</p>
				
				<p>Are the goods undamaged?</p>
			<p>Do the nameplate data match the ordering information on the delivery note?</p>	
			<p>Is the CD-ROM with the Technical Documentation (depends on device version) and documents present?</p>	



-  If one of the conditions is not satisfied, contact your Endress+Hauser Sales Center.
- Depending on the device version, the CD-ROM might not be part of the delivery! The Technical Documentation is available via the Internet or via the *Endress+Hauser Operations App*, see the "Product identification" section → 13.

### 4.2 Product identification

The following options are available for identification of the measuring device:

- Nameplate specifications
- Order code with breakdown of the device features on the delivery note
- Enter serial numbers from nameplates in *W@M Device Viewer* ([www.endress.com/deviceviewer](http://www.endress.com/deviceviewer)): All information about the measuring device is displayed.
- Enter the serial number from the nameplates into the *Endress+Hauser Operations App* or scan the 2-D matrix code (QR code) on the nameplate with the *Endress+Hauser Operations App*: all the information for the measuring device is displayed.

For an overview of the scope of the associated Technical Documentation, refer to the following:

- The chapters "Additional standard documentation on the device" →  8 and "Supplementary device-dependent documentation" →  8
- The *W@M Device Viewer*: Enter the serial number from the nameplate ([www.endress.com/deviceviewer](http://www.endress.com/deviceviewer))
- The *Endress+Hauser Operations App*: Enter the serial number from the nameplate or scan the 2-D matrix code (QR code) on the nameplate.

### 4.2.1 Transmitter nameplate

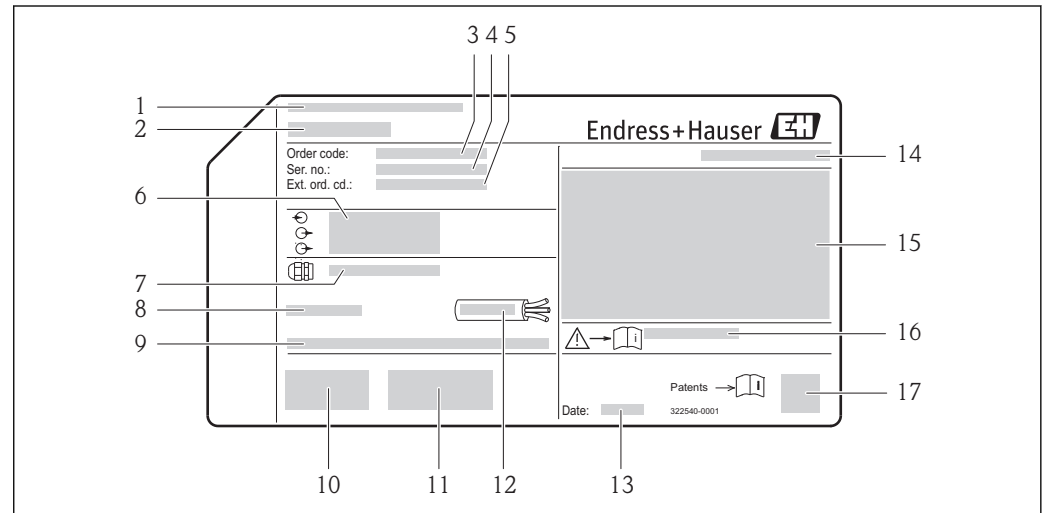

A0013906

 2 Example of a transmitter nameplate

- 1 Manufacturing location
- 2 Name of the transmitter
- 3 Order code
- 4 Serial number (Ser. no.)
- 5 Extended order code (Ext. ord. cd.)
- 6 Electrical connection data, e.g. available inputs and outputs, supply voltage
- 7 Type of cable glands
- 8 Permitted ambient temperature ( $T_a$ )
- 9 Firmware version (FW) from the factory
- 10 CE mark, C-Tick
- 11 Additional information on version: certificates, approvals
- 12 Permitted temperature range for cable
- 13 Manufacturing date: year-month
- 14 Degree of protection
- 15 Approval information for explosion protection
- 16 Document number of safety-related supplementary documentation
- 17 2-D matrix code

## 4.2.2 Sensor nameplate

Order code for "Housing" option C "GT20 two-chamber, aluminum coated"

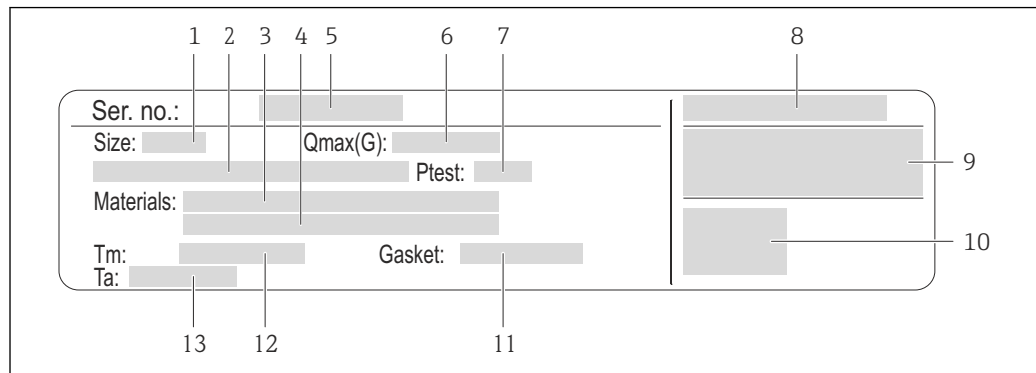

A0020758

3 Example of a sensor nameplate

- 1 Nominal diameter of the sensor
- 2 Flange nominal diameter/nominal pressure
- 3 Measuring tube material
- 4 Measuring tube material
- 5 Serial number (Ser. no.)
- 6 Maximal permitted volume flow (gas/steam)
- 7 Test pressure of the sensor
- 8 Degree of protection
- 9 Approval information for explosion protection and Pressure Equipment Directive
- 10 CE mark
- 11 Seal material
- 12 Medium temperature range
- 13 Ambient temperature range

## Order code for "Housing" option J "GT20 two-chamber, remote, aluminum coated"

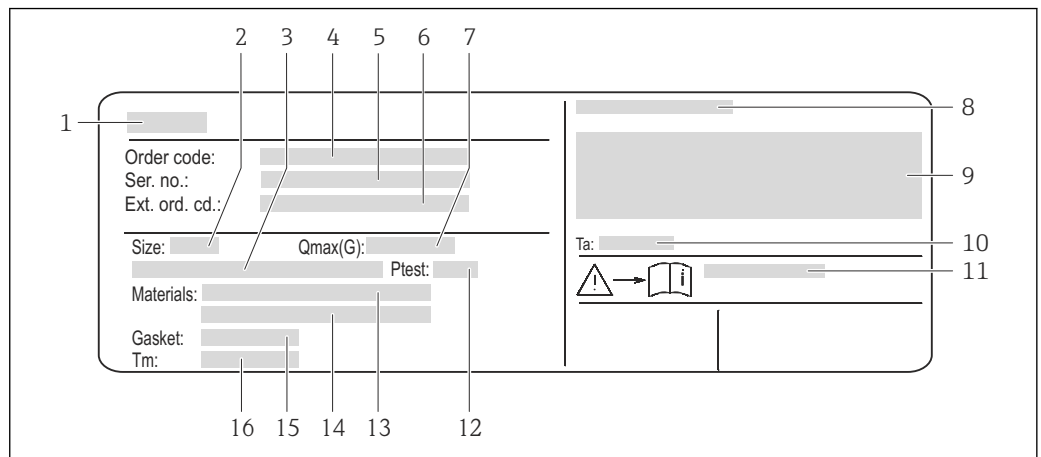

A0020759

4 Example of a sensor nameplate

- 1 Name of the sensor
- 2 Nominal diameter of the sensor
- 3 Flange nominal diameter/nominal pressure
- 4 Order code
- 5 Serial number (Ser. no.)
- 6 Extended order code (Ext. ord. cd.)
- 7 Maximal permitted volume flow (gas/steam)
- 8 Degree of protection
- 9 Approval information for explosion protection and Pressure Equipment Directive
- 10 Ambient temperature range
- 11 Document number of safety-related supplementary documentation → 208
- 12 Test pressure of the sensor
- 13 Measuring tube material
- 14 Measuring tube material
- 15 Seal material
- 16 Medium temperature range

### Order code

The measuring device is reordered using the order code.

#### Extended order code

- The device type (product root) and basic specifications (mandatory features) are always listed.
- Of the optional specifications (optional features), only the safety and approval-related specifications are listed (e.g. LA). If other optional specifications are also ordered, these are indicated collectively using the # placeholder symbol (e.g. #LA#).
- If the ordered optional specifications do not include any safety and approval-related specifications, they are indicated by the + placeholder symbol (e.g. XXXXXX-ABCDE+).

**Additional sensor nameplate**

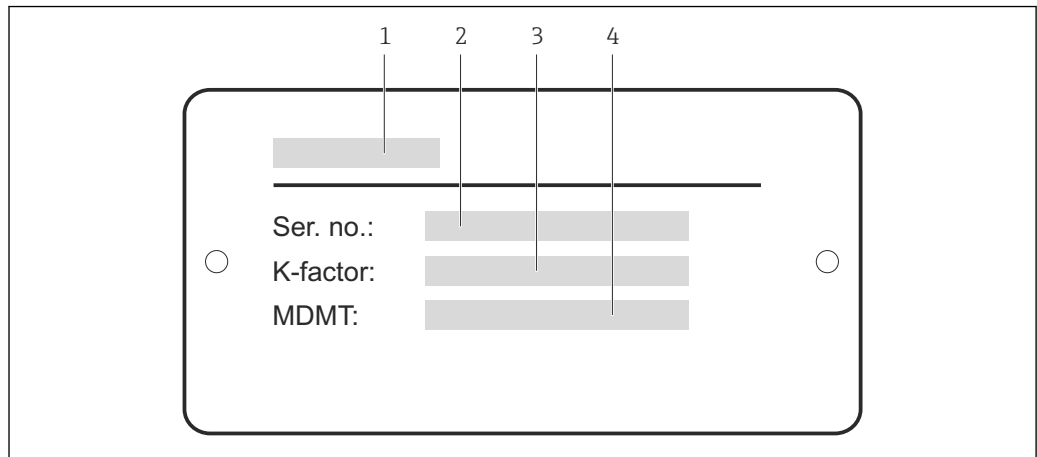

A0021042

5 Example of an additional sensor nameplate

- 1 Name of the sensor
- 2 Serial number (Ser. no.)
- 3 K-factor
- 4 Minimum permitted material temperature

**4.2.3 Symbols on measuring device**

Symbol	Meaning
	<b>WARNING!</b> This symbol alerts you to a dangerous situation. Failure to avoid this situation can result in serious or fatal injury.
	<b>Reference to documentation</b> Refers to the corresponding device documentation.
	<b>Protective ground connection</b> A terminal which must be connected to ground prior to establishing any other connections.



## 5 Storage and transport

### 5.1 Storage conditions

Observe the following notes for storage:

- Store in the original packaging to ensure protection from shock.
- Do not remove protective covers or protective caps installed on process connections. They prevent mechanical damage to the sealing surfaces and contamination in the measuring tube.
- Protect from direct sunlight to avoid unacceptably high surface temperatures.
- Store in a dry and dust-free place.
- Do not store outdoors.

Storage temperature:

- All components apart from the display modules:  $-50$  to  $+80$  °C ( $-58$  to  $+176$  °F)
- Display modules:  $-40$  to  $+80$  °C ( $-40$  to  $+176$  °F)

### 5.2 Transporting the product

Transport the measuring device to the measuring point in the original packaging.

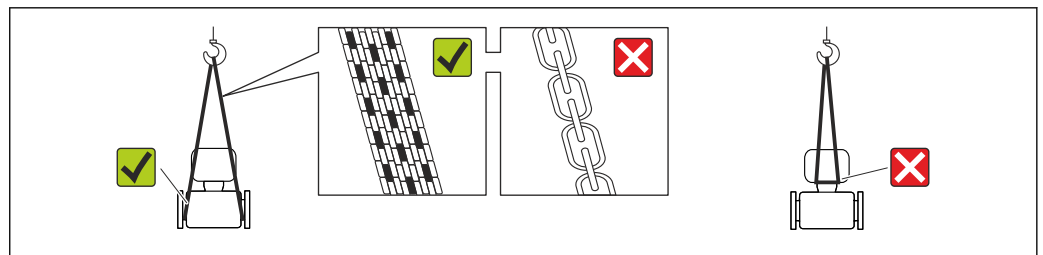

A0015604

- i** Do not remove protective covers or caps installed on process connections. They prevent mechanical damage to the sealing surfaces and contamination in the measuring tube.

#### 5.2.1 Measuring devices without lifting lugs

##### **⚠ WARNING**

**Center of gravity of the measuring device is higher than the suspension points of the webbing slings.**

Risk of injury if the measuring device slips.

- ▶ Secure the measuring device against slipping or turning.
- ▶ Observe the weight specified on the packaging (stick-on label).

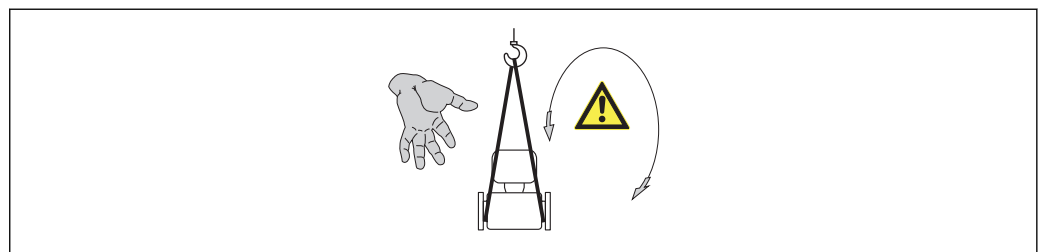

A0015606

## 5.2.2 Measuring devices with lifting lugs

### **⚠ CAUTION**

#### **Special transportation instructions for devices with lifting lugs**

- ▶ Only use the lifting lugs fitted on the device or flanges to transport the device.
- ▶ The device must always be secured at two lifting lugs at least.

## 5.2.3 Transporting with a fork lift

If transporting in wood crates, the floor structure enables the crates to be lifted lengthwise or at both sides using a forklift.

## 5.3 Packaging disposal

All packaging materials are environmentally friendly and 100% recyclable:

- Measuring device secondary packaging: polymer stretch film that conforms to EC Directive 2002/95/EC (RoHS).
- Packaging:
  - Wood crate, treated in accordance with ISPM 15 standard, which is confirmed by the affixed IPPC logo.
  - or
  - Carton in accordance with European Packaging Directive 94/62EC; recyclability is confirmed by the affixed RESY symbol.
- Seaworthy packaging (optional): Wood crate, treated in accordance with ISPM 15 standard, which is confirmed by the affixed IPPC logo.
- Carrying and mounting hardware:
  - Disposable plastic pallet
  - Plastic straps
  - Plastic adhesive strips
- Dunnage: Paper cushion

## 6 Installation

### 6.1 Installation conditions

#### 6.1.1 Mounting position

##### Mounting location

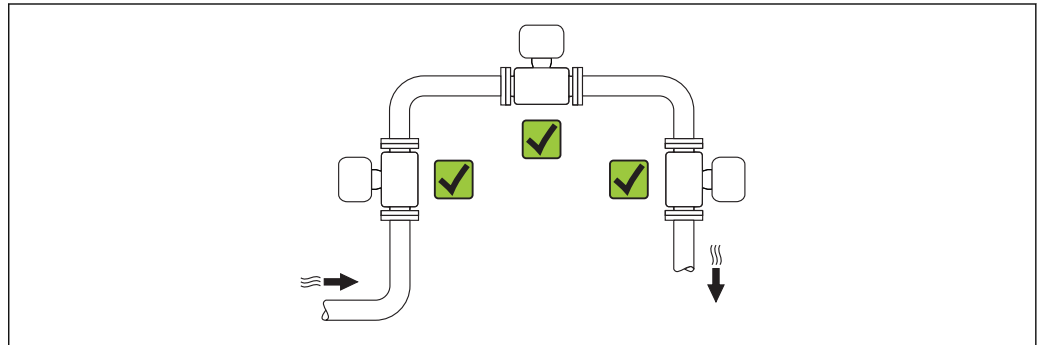

A0015543

##### Orientation

The direction of the arrow on the sensor nameplate helps you to install the sensor according to the flow direction (direction of medium flow through the piping).

Vortex meters require a fully developed flow profile as a prerequisite for correct volume flow measurement. Therefore, please note the following:

Orientation		Compact version	Remote version
<b>A</b>	Vertical orientation	✓✓ <sup>1)</sup>	✓✓
<b>B</b>	Horizontal orientation, transmitter head up	✓✓ <sup>2) 3)</sup>	✓✓
<b>C</b>	Horizontal orientation, transmitter head down	✓✓ <sup>4) 5)</sup>	✓✓
<b>D</b>	Horizontal orientation, transmitter head at side	✓✓ <sup>4)</sup>	✓✓

- 1) In the case of liquids, there should be upward flow in vertical pipes to avoid partial pipe filling (Fig. A). Disruption in flow measurement! In the case of vertical orientation and downward flowing liquid, the pipe always needs to be completely filled to ensure correct liquid flow measurement.
- 2) Danger of electronics overheating! If the fluid temperature is  $\geq 200\text{ °C}$  ( $392\text{ °F}$ ) orientation B is not permitted for the wafer version (Prowirl D) with nominal diameters DN 100 (4") and DN 150 (6").
- 3) In the case of hot media (e.g. steam or fluid temperature (TM)  $\geq 200\text{ °C}$  ( $392\text{ °F}$ ): orientation C or D
- 4) In the case of very cold media (e.g. liquid nitrogen): orientation B or D
- 5) For "wet steam detection/measurement" option: orientation C

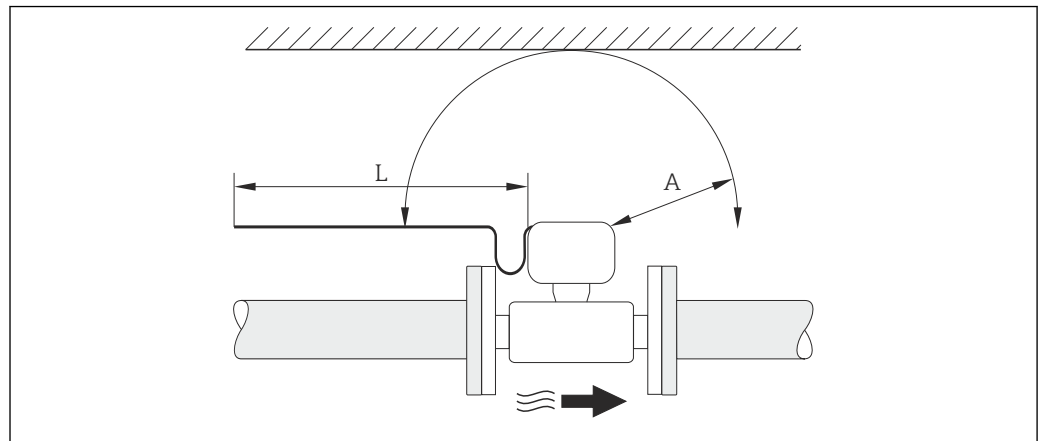
*Minimum spacing and cable length*

A0019211

- A* Minimum spacing in all directions  
*L* Required cable length

The following dimensions must be observed to guarantee problem-free access to the device for service purposes:

- $A = 100 \text{ mm}$  (3.94 in)
- $L = L + 150 \text{ mm}$  (5.91 in)

*Rotating the electronics housing and the display*

The electronics housing can be rotated continuously by  $360^\circ$  on the housing support. The display unit can be rotated in  $45^\circ$  stages. This means you can read the display comfortably from all directions.

**Inlet and outlet runs**

To attain the specified level of accuracy of the measuring device, the inlet and outlet runs mentioned below must be maintained at the very minimum.

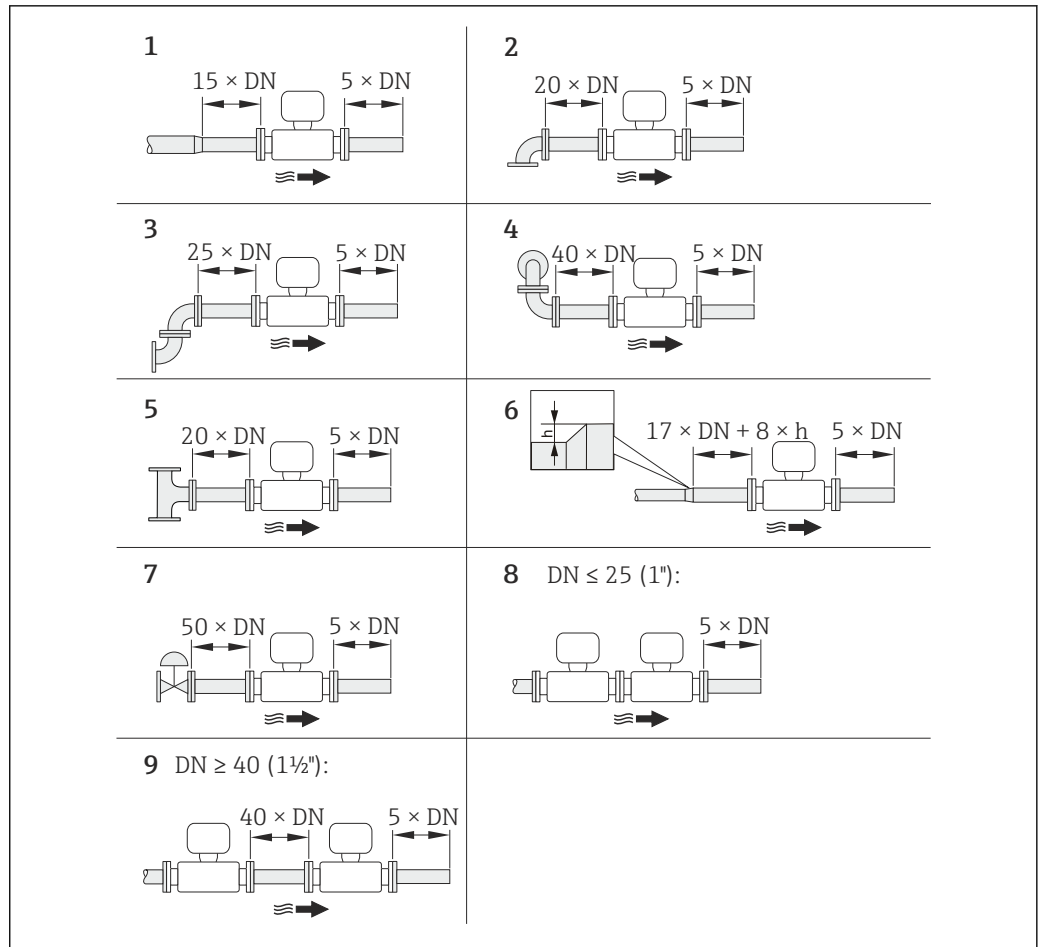

A0019189

6 Minimum inlet and outlet runs with various flow obstructions

$h$  Difference in expansion

1 Reduction by one nominal diameter size

2 Single elbow (90° elbow)

3 Double elbow (2 × 90° elbows, opposite)

4 Double elbow 3D (2 × 90° elbows, opposite, not on one plane)

5 T-piece

6 Expansion

7 Control valve

8 Two measuring devices in a row where  $DN \leq 25$  (1"): directly flange on flange

9 Two measuring devices in a row where  $DN \geq 40$  (1½"): for spacing, see graphic

### Outlet runs when installing external devices

If installing an external device, observe the specified distance.

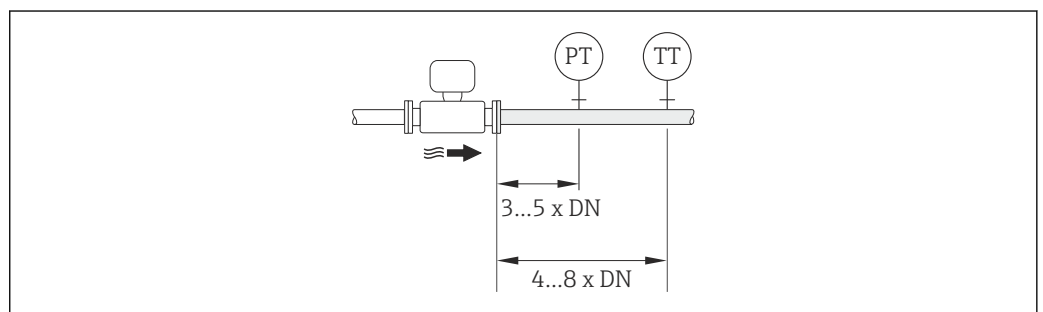

A0019205

PT Pressure transmitter

TT Temperature transmitter

*Installation dimensions*

For the dimensions and installation lengths of the device, see the "Technical Information" document, "Mechanical construction" section

**6.1.2 Requirements from environment and process****Ambient temperature range***Compact version*

<b>Measuring device</b>	Non-Ex:	-40 to +80 °C (-40 to +176 °F) <sup>1)</sup>
	Ex i:	-40 to +70 °C (-40 to +158 °F) <sup>1)</sup>
	EEx d/XP version:	-40 to +60 °C (-40 to +140 °F) <sup>1)</sup>
	ATEX II1/2G Ex d, Ex ia:	-40 to +60 °C (-40 to +140 °F) <sup>1)</sup>
<b>Local display</b>		-20 to +70 °C (-4 to +158 °F) <sup>1)</sup>

1) Additionally available as order code for "Test, certificate", option JN "Transmitter ambient temperature -50 °C (-58 °F)".

*Remote version*

<b>Transmitter</b>	Non-Ex:	-40 to +80 °C (-40 to +176 °F) <sup>1)</sup>
	Ex i:	-40 to +80 °C (-40 to +176 °F) <sup>1)</sup>
	Ex d:	-40 to +60 °C (-40 to +140 °F) <sup>1)</sup>
	ATEX II1/2G Ex d, Ex ia:	-40 to +60 °C (-40 to +140 °F) <sup>1)</sup>
<b>Sensor</b>	Non-Ex:	-40 to +85 °C (-40 to +185 °F) <sup>1)</sup>
	Ex i:	-40 to +85 °C (-40 to +185 °F) <sup>1)</sup>
	Ex d:	-40 to +85 °C (-40 to +185 °F) <sup>1)</sup>
	ATEX II1/2G Ex d, Ex ia:	-40 to +85 °C (-40 to +185 °F) <sup>1)</sup>
<b>Local display</b>		-20 to +70 °C (-4 to +158 °F) <sup>1)</sup>

1) Additionally available as order code for "Test, certificate", option JN "Transmitter ambient temperature -50 °C (-58 °F)".

- ▶ If operating outdoors:  
Avoid direct sunlight, particularly in warm climatic regions.

**Thermal insulation**

For optimum temperature measurement and mass calculation, heat transfer at the sensor must be avoided for some fluids. This can be ensured by installing thermal insulation. A wide range of materials can be used for the required insulation.

This applies for:

- Compact version
- Remote sensor version

The maximum insulation height permitted is illustrated in the diagram:

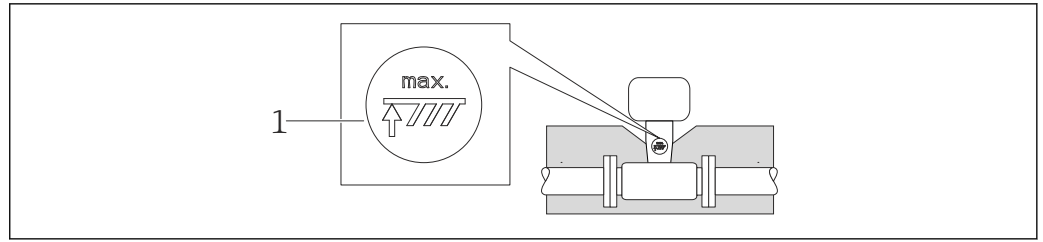

A0019212

1 Maximum insulation height

- ▶ When insulating, ensure that a sufficiently large area of the housing support remains exposed.

The uncovered part serves as a radiator and protects the electronics from overheating and excessive cooling.

#### NOTICE

#### Electronics overheating on account of thermal insulation!

- ▶ Observe the maximum permitted insulation height of the transmitter neck so that the transmitter head and/or the connection housing of the remote version is completely free.
- ▶ Observe information on the permissible temperature ranges .
- ▶ Note that a certain orientation might be required, depending on the fluid temperature → ☰ 19.

#### Vibrations

The correct operation of the measuring system is not affected by plant vibrations up to 1 g, 10 to 500 Hz. Therefore no special measures are needed to secure the sensors.

### 6.1.3 Special mounting instructions

#### Inspection kit

The inspection kit contains the necessary parts for the annual visual inspection of the primary measurement element (bluff body) in accordance with ERCB Dir. 017.

Consists of:

- 2 inspection centering sleeves
- 8 screws
- 2 inspection seals
- 2 inspection covers

The centering sleeve supports the user by centering the calipers in the inspection ports. This makes it easier to measure the distance from the sealing surface to the bluff body. In addition, the kit also contains screws, seals and covers for the inspection ports.



An inspection kit can be ordered separately (see the "Accessories" section → ☰ 183).

#### Installation for delta heat measurements

Order code for "Sensor version", option 3 "Mass flow (integrated temperature measurement)"

The second temperature measurement is taken using a separate temperature sensor. The measuring device reads in this value via a communication interface.

- In the case of saturated steam delta heat measurements, the Prowirl 200 must be installed on the steam side.
- In the case of water delta heat measurements, the Prowirl 200 can be installed on the cold or warm side.

**i** In the case of saturated steam delta heat measurements, the value **0 bar abs.** must be set in the **Fixed process pressure** parameter (→ 77) in order for the measuring device to calculate on the saturated steam curve.

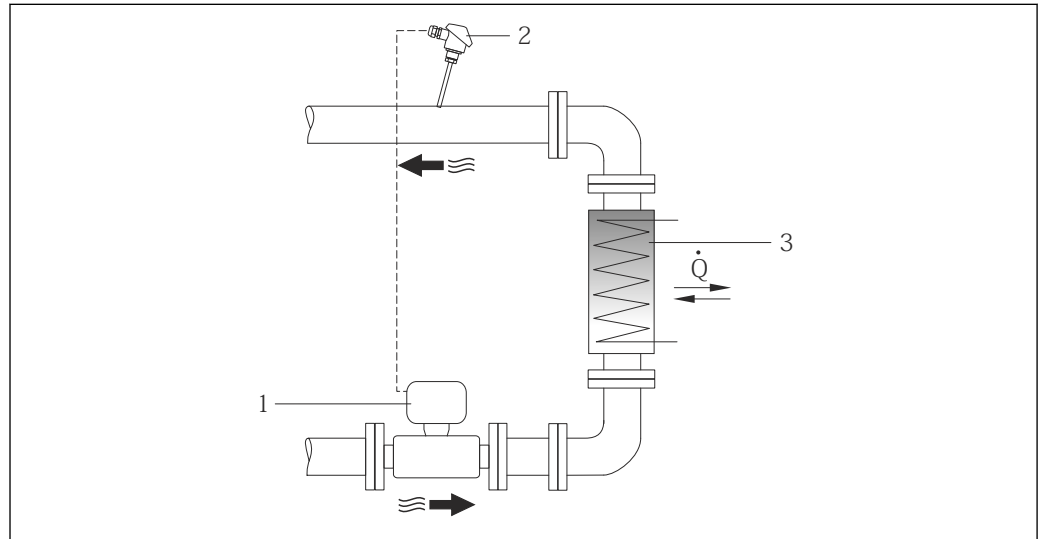

A0019209

**7** Layout for delta heat measurement of saturated steam and water

- 1 Prowirl
- 2 Temperature sensor
- 3 Heat exchanger
- Q Heat flow

### Weather protection cover

Observe the following minimum head clearance: 222 mm (8.74 in)

**i** For information on the weather protection cover, see → 182

## 6.2 Mounting the measuring device

### 6.2.1 Required tools

#### For transmitter

- For turning the transmitter housing: Open-ended wrench 8 mm
- For opening the securing clamps: Allen key 3 mm

#### For sensor

For flanges and other process connections: Corresponding mounting tools

### 6.2.2 Preparing the measuring device

1. Remove all remaining transport packaging.
2. Remove any protective covers or protective caps present from the sensor.



3. Remove stick-on label on the electronics compartment cover.

### 6.2.3 Mounting the sensor

#### **⚠ WARNING**

#### **Danger due to improper process sealing!**

- ▶ Ensure that the inside diameters of the gaskets are greater than or equal to that of the process connections and piping.
- ▶ Ensure that the gaskets are clean and undamaged.
- ▶ Install the gaskets correctly.

1. Ensure that the direction of the arrow on the sensor matches the flow direction of the medium.
2. To ensure compliance with device specifications, install the measuring device between the pipe flanges in a way that it is centered in the measurement section.
3. Install the measuring device or turn the transmitter housing so that the cable entries do not point upwards.

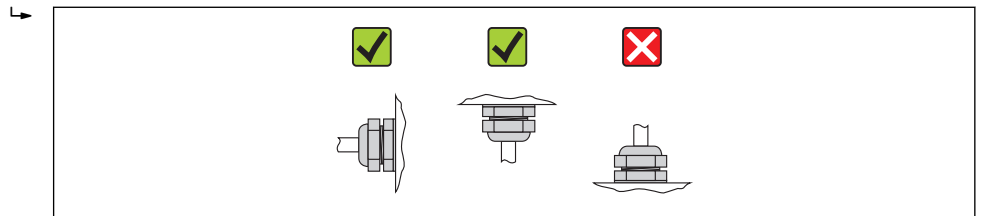

A0013964

### 6.2.4 Mounting the transmitter of the remote version

#### **⚠ CAUTION**

#### **Ambient temperature too high!**

Danger of electronics overheating and housing deformation.

- ▶ Do not exceed the permitted maximum ambient temperature .
- ▶ If operating outdoors: Avoid direct sunlight and exposure to weathering, particularly in warm climatic regions.

#### **⚠ CAUTION**

#### **Excessive force can damage the housing!**

- ▶ Avoid excessive mechanical stress.

The transmitter of the remote version can be mounted in the following ways:

- Wall mounting
- Pipe mounting

### Wall mounting

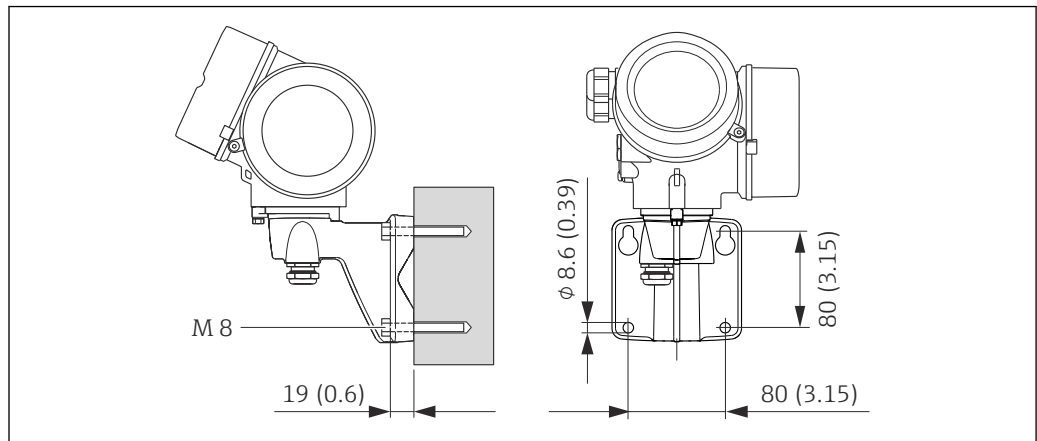

A0019864

8 Engineering unit mm (in)

1. Drill the holes.
2. Insert wall plugs into the drilled holes.
3. Screw in the securing screws slightly at first.
4. Fit the transmitter housing over the securing screws and mount in place.
5. Tighten the securing screws.

### Post mounting

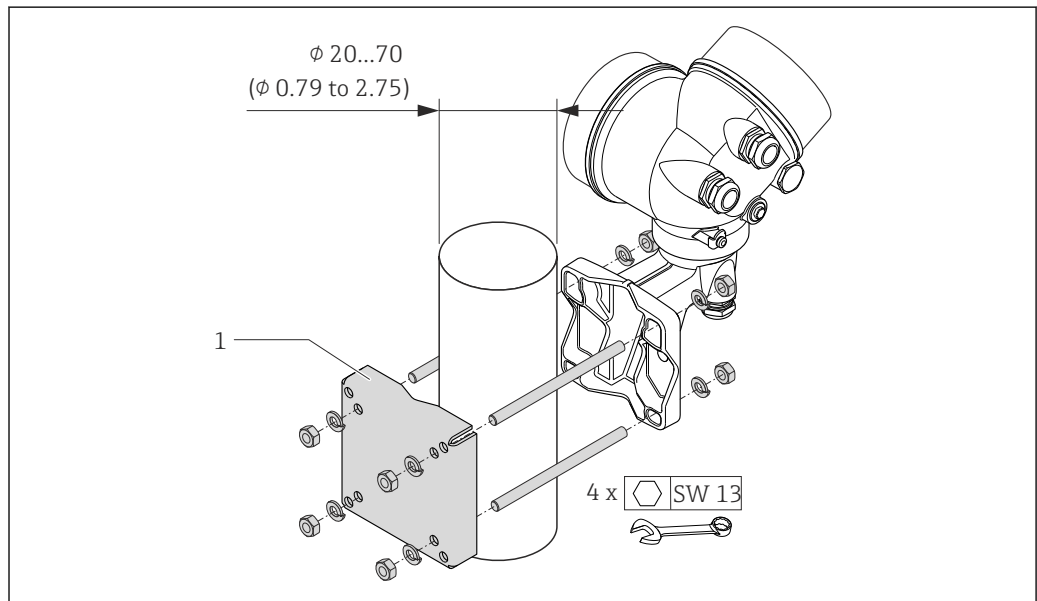

A0019862

9 Engineering unit mm (in)

1 Post retainer kit for post mounting

### 6.2.5 Turning the transmitter housing

To provide easier access to the connection compartment or display module, the transmitter housing can be turned.

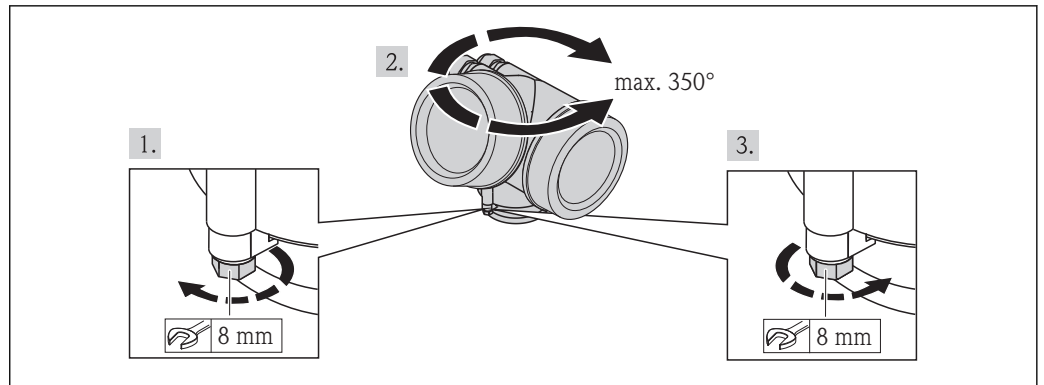

A0013713

1. Release the fixing screw.
2. Turn the housing to the desired position.
3. Firmly tighten the securing screw.

### 6.2.6 Turning the display module

The display module can be turned to optimize display readability and operability.

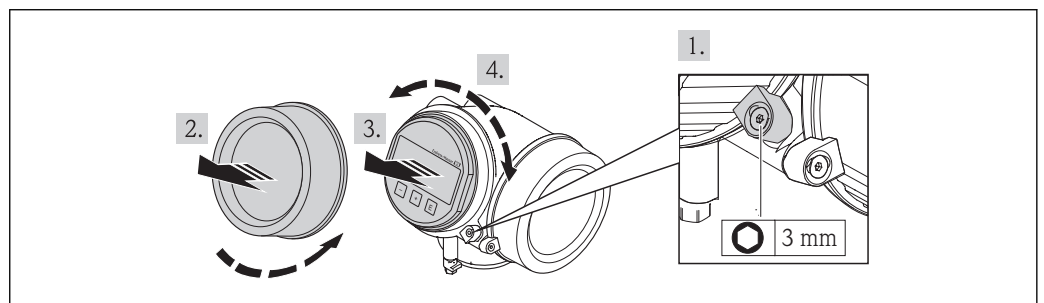

A0013905

1. Loosen the securing clamp of the electronics compartment cover using an Allen key.
2. Unscrew cover of the electronics compartment from the transmitter housing.
3. Optional: pull out the display module with a gentle rotational movement.
4. Rotate the display module into the desired position: Max.  $8 \times 45^\circ$  in each direction.
5. Without display module pulled out:  
Allow display module to engage at desired position.
6. With display module pulled out:  
Feed the cable into the gap between the housing and main electronics module and plug the display module into the electronics compartment until it engages.
7. Reverse the removal procedure to reassemble the transmitter.

## 6.3 Post-installation check

Is the device undamaged (visual inspection)?	<input type="checkbox"/>
--	--------------------------

<p>Does the measuring device conform to the measuring point specifications?</p> <p>For example:</p> <ul style="list-style-type: none"> <li>▪ Process temperature</li> <li>▪ Process pressure (refer to the section on "Pressure-temperature ratings" in the "Technical Information" document )</li> <li>▪ Ambient temperature</li> <li>▪ Measuring range → 189</li> </ul>	<input type="checkbox"/>
<p>Has the correct orientation for the sensor been selected → 19?</p> <ul style="list-style-type: none"> <li>▪ According to sensor type</li> <li>▪ According to medium temperature</li> <li>▪ According to medium properties (outgassing, with entrained solids)</li> </ul>	<input type="checkbox"/>
<p>Does the arrow on the sensor nameplate match the direction of flow of the fluid through the piping → 19?</p>	<input type="checkbox"/>
<p>Are the measuring point identification and labeling correct (visual inspection)?</p>	<input type="checkbox"/>
<p>Is the device adequately protected from precipitation and direct sunlight?</p>	<input type="checkbox"/>
<p>Are the securing screw and securing clamp tightened securely?</p>	<input type="checkbox"/>

## 7 Electrical connection

 The measuring device does not have an internal circuit breaker. For this reason, assign the measuring device a switch or power-circuit breaker so that the power supply line can be easily disconnected from the mains.

### 7.1 Connection conditions

#### 7.1.1 Required tools

- For cable entries: Use corresponding tools
- For securing clamp: Allen key 3 mm
- Wire stripper
- When using stranded cables: crimping tool for ferrule
- For removing cables from terminal: flat blade screwdriver  $\leq 3$  mm (0.12 in)

#### 7.1.2 Connecting cable requirements

The connecting cables provided by the customer must fulfill the following requirements.

##### Electrical safety

In accordance with applicable federal/national regulations.

##### Permitted temperature range

- $-40$  °C ( $-40$  °F) to  $+80$  °C ( $+176$  °F)
- Minimum requirement: cable temperature range  $\geq$  ambient temperature  $+20$  K

##### Signal cable

*PROFIBUS PA*

Twisted, shielded two-wire cable. Cable type A is recommended →  30.

-  For further information on planning and installing PROFIBUS PA networks see:
- Operating Instructions "PROFIBUS DP/PA: Guidelines for planning and commissioning" (BA00034S)
  - PNO Directive 2.092 "PROFIBUS PA User and Installation Guideline"
  - IEC 61158-2 (MBP)

##### *Pulse/frequency/switch output*

Standard installation cable is sufficient.

##### Connecting cable for remote version

*Connecting cable (standard)*

<b>Standard cable</b>	$2 \times 2 \times 0.34$ mm <sup>2</sup> (22 AWG) PVC cable with common shield (2 pairs, pair-stranded)
<b>Flame resistance</b>	According to DIN EN 60332-1-2
<b>Oil-resistance</b>	According to DIN EN 60811-2-1
<b>Shielding</b>	Galvanized copper-braid, opt. density approx. 85%
<b>Cable length</b>	5 m (16 ft), 10 m (32 ft), 20 m (65 ft), 30 m (98 ft)
<b>Operating temperature</b>	When mounted in a fixed position: $-50$ to $+105$ °C ( $-58$ to $+221$ °F); when cable can move freely: $-25$ to $+105$ °C ( $-13$ to $+221$ °F)

*Connecting cable (reinforced)*

<b>Cable, reinforced</b>	2 × 2 × 0.34 mm <sup>2</sup> (22 AWG) PVC cable with common shield (2 pairs, pair-stranded) and additional steel-wire braided sheath
<b>Flame resistance</b>	According to DIN EN 60332-1-2
<b>Oil-resistance</b>	According to DIN EN 60811-2-1
<b>Shielding</b>	Galvanized copper-braid, opt. density approx. 85%
<b>Strain relief and reinforcement</b>	Steel-wire braid, galvanized
<b>Cable length</b>	5 m (16 ft), 10 m (32 ft), 20 m (65 ft), 30 m (98 ft)
<b>Operating temperature</b>	When mounted in a fixed position: -50 to +105 °C (-58 to +221 °F); when cable can move freely: -25 to +105 °C (-13 to +221 °F)

**Cable diameter**

- Cable glands supplied:  
M20 × 1.5 with cable  $\phi$  6 to 12 mm (0.24 to 0.47 in)
- Plug-in spring terminals for device version without integrated overvoltage protection:  
wire cross-sections 0.5 to 2.5 mm<sup>2</sup> (20 to 14 AWG)
- Screw terminals for device version with integrated overvoltage protection: wire cross-sections 0.2 to 2.5 mm<sup>2</sup> (24 to 14 AWG)

**Fieldbus cable specification***PROFIBUS PA**Cable type*

In accordance with IEC 61158-2 (MBP), cable type A is recommended. Cable type A has a cable shielding that guarantees adequate protection from electromagnetic interference and thus the most reliable data transfer.

The electrical data of the fieldbus cable have not been specified but determine important characteristics of the design of the fieldbus, such as distances bridged, number of users, electromagnetic compatibility, etc.

<b>Cable type</b>	A
<b>Cable structure</b>	Twisted, shielded twin-core cable
<b>Wire cross-section</b>	0.8 mm <sup>2</sup> (AWG 18)
<b>Loop resistance (direct current)</b>	44 $\Omega$ /km
<b>Characteristic impedance at 31.25 kHz</b>	100 $\Omega$ $\pm$ 20%
<b>Attenuation constant at 39.0 kHz</b>	3 dB/km
<b>Capacitive asymmetry</b>	2 nF/km
<b>Envelope delay distortion (7.9 to 39 kHz)</b>	1.7 ms/km
<b>Shield coverage</b>	90 %

The following are examples of suitable cable types:

Non-hazardous area:

- Siemens 6XV1 830-5BH10
- Belden 3076F
- Kerpen CEL-PE/OSCR/PVC/FRLA FB-02YS(ST)YFL

*Maximum overall cable length*

The maximum network expansion depends on the type of protection and the cable specifications. The overall cable length combines the length of the main cable and the length of all spurs >1 m (3.28 ft).

The maximum overall cable length for cable type A: 1 900 m (6 200 ft)

If repeaters are used, the maximum permissible cable length is doubled. A maximum of three repeaters are permitted between the user and master.

*Maximum spur length*

The line between the distribution box and field device is described as a spur. In the case of non-Ex applications, the max. length of a spur depends on the number of spurs >1 m (3.28 ft):

Number of spurs	Max. length per spur
1...12	120 m (400 ft)
13...14	90 m (300 ft)
15...18	60 m (200 ft)
19...24	30 m (100 ft)
25...32	1 m (3 ft)

*Number of field devices*

In the case of systems in accordance with the Fieldbus Intrinsically Safe Concept (FISCO) with EEx ia explosion protection, the cable length is limited to a maximum length of 1000 m (3300 ft). A maximum of 32 users per segment in non-Ex areas or a maximum of 10 users in an Ex-area (EEx ia IIC) is possible. The actual number of users must be determined during the planning stage.

*Bus termination*

The start and end of each fieldbus segment must always be terminated by a bus terminator. With various junction boxes (non-Ex), the bus termination can be activated via a switch. If this is not the case, a separate bus terminator must be installed. Please also note the following:

- In the case of a branched bus segment, the device furthest from the segment coupler represents the end of the bus.
- If the fieldbus is extended with a repeater then the extension must also be terminated at both ends.

### 7.1.3 Terminal assignment

#### Transmitter

Connection version for PROFIBUS PA, pulse/frequency/switch output

<p style="text-align: right; font-size: small;">A0013570</p>	<p style="text-align: right; font-size: small;">A0018161</p>
<p>Maximum number of terminals</p>	<p>Maximum number of terminals for order code for "Accessory mounted", option NA "Overvoltage protection"</p>
<p>1 Output 1: PROFIBUS PA                  2 Output 2 (passive: pulse/frequency/switch output                  3 Ground terminal for cable shield</p>	

Order code for "Output"	Terminal numbers			
	Output 1		Output 2	
	1 (+)	2 (-)	3 (+)	4 (-)
Option <b>G</b> <sup>1) 2)</sup>	PROFIBUS PA		Pulse/frequency/switch output (passive)	

- 1) Output 1 must always be used; output 2 is optional.
- 2) PROFIBUS PA with integrated reverse polarity protection.

#### Remote version

In the case of the remote version, the sensor and transmitter are mounted separately from one another and connected by a connecting cable. The sensor is connected via the connection housing while the transmitter is connected via the connection compartment of the wall holder unit.

**i** The way the transmitter wall holder is connected depends on the measuring device approval and the version of the connecting cable used.

- Connection is only possible via terminals:
- For approvals Ex n, Ex tb and cCSAus Div. 1
  - If a reinforced connecting cable is used

- The connection is via an M12 connector:
- For all other approvals
  - If the standard connecting cable is used

Connection to the connection housing of the sensor is always via the terminals (tightening torque for terminals: 1.2 to 1.7 Nm).



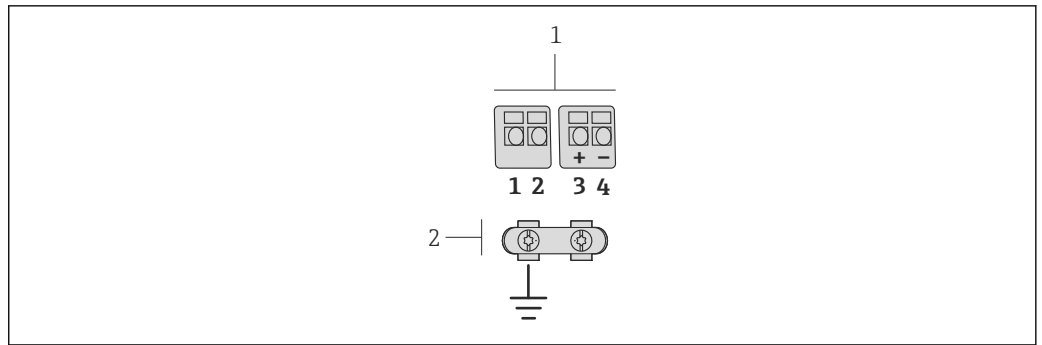

10 Terminals for connection compartment in the transmitter wall holder and the sensor connection housing  
 1 Terminals for connecting cable  
 2 Grounding via the cable strain relief

Terminal number	Assignment	Cable color Connecting cable
1	Supply voltage	Brown
2	Grounding	White
3	RS485 (+)	Yellow
4	RS485 (-)	Green

### 7.1.4 Pin assignment, device plug

#### PROFIBUS PA

Device plug for signal transmission (device side)

Pin	Assignment		Coding	Plug/socket
	Pin	Assignment		
1	+	PROFIBUS PA +	A	Plug
2		Grounding		
3	-	PROFIBUS PA -		
4		Not assigned		

### 7.1.5 Shielding and grounding

#### PROFIBUS PA

Optimum electromagnetic compatibility (EMC) of the fieldbus system can only be guaranteed if the system components and, in particular, the lines are shielded and the shield forms as complete a cover as possible. A shield coverage of 90% is ideal.

- To ensure an optimum EMC protective effect, connect the shield as often as possible to the reference ground.
- For reasons of explosion protection, you should refrain from grounding however.

To comply with both requirements, the fieldbus system allows three different types of shielding:

- Shielding at both ends.
- Shielding at one end on the feed side with capacitance termination at the field device.
- Shielding at one end on the feed side.

Experience shows that the best results with regard to EMC are achieved in most cases in installations with one-sided shielding on the feed side (without capacitance termination at the field device). Appropriate measures with regard to input wiring must be taken to allow unrestricted operation when EMC interference is present. These measures have been

taken into account for this device. Operation in the event of disturbance variables as per NAMUR NE21 is thus guaranteed.

Where applicable, national installation regulations and guidelines must be observed during the installation!

Where there are large differences in potential between the individual grounding points, only one point of the shielding is connected directly with the reference ground. In systems without potential equalization, therefore, cable shielding of fieldbus systems should only be grounded on one side, for example at the fieldbus supply unit or at safety barriers.

#### NOTICE

**In systems without potential matching, the multiple grounding of the cable shield causes mains frequency equalizing currents!**

Damage to the bus cable shield.

- ▶ Only ground the bus cable shield to either the local ground or the protective ground at one end. Insulate the shield that is not connected.

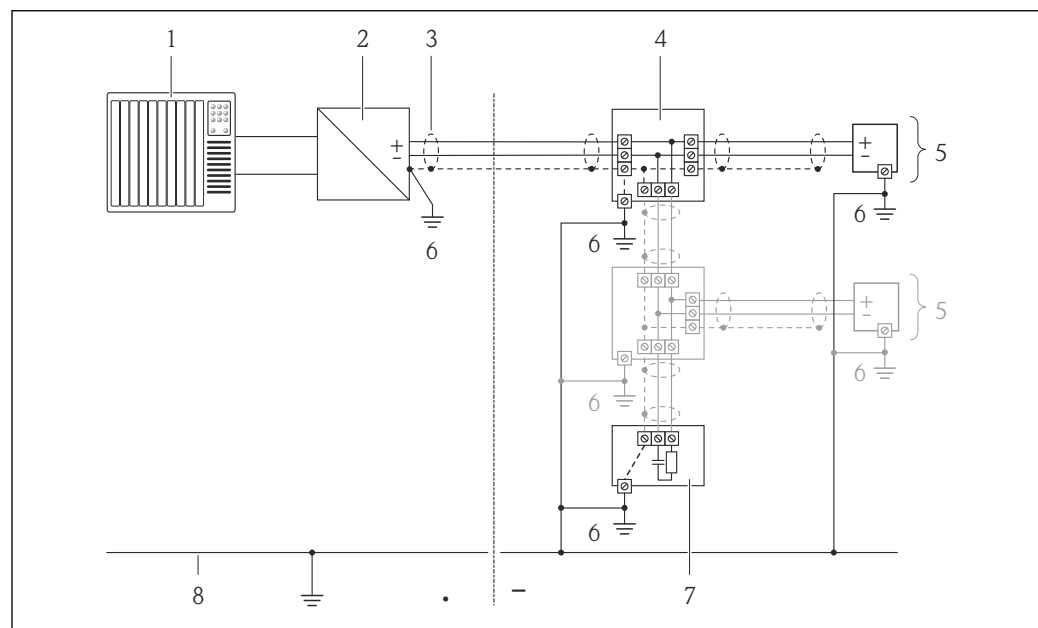

- 1 Controller (e.g. PLC)
- 2 Segment coupler PROFIBUS DP/PA
- 3 Cable shield
- 4 T-box
- 5 Measuring device
- 6 Local grounding
- 7 Bus terminator
- 8 Potential matching line

### 7.1.6 Requirements for the supply unit

#### Supply voltage

##### Transmitter

An external power supply is required for each output.

The following supply voltage values apply for the outputs available:

*Supply voltage for a compact version without a local display<sup>1)</sup>*

Order code for "Output"	Minimum terminal voltage <sup>2)</sup>	Maximum terminal voltage
Option G: PROFIBUS PA, pulse/frequency/switch output	≥ DC 9 V	DC 32 V

1) In event of external supply voltage of the PROFIBUS DP/PA coupler

2) The minimum terminal voltage increases if local operation is used: see the following table

*Increase in minimum terminal voltage*

Local operation	Increase in minimum terminal voltage
Order code for "Display; Operation", option C: Local operation SDO2	+ DC 1 V
Order code for "Display; Operation", option E: Local operation SDO3 with lighting (backlighting <b>not used</b> )	+ DC 1 V
Order code for "Display; Operation", option E: Local operation SDO3 with lighting (backlighting <b>used</b> )	+ DC 3 V

**7.1.7 Preparing the measuring device**

1. Remove dummy plug if present.

2. **NOTICE**

**Insufficient sealing of the housing!**

Operational reliability of the measuring device could be compromised.

- ▶ Use suitable cable glands corresponding to the degree of protection.

If measuring device is delivered without cable glands:

Provide suitable cable gland for corresponding connecting cable .

3. If measuring device is delivered with cable glands:

Observe cable specification .

**7.2 Connecting the measuring device****NOTICE****Limitation of electrical safety due to incorrect connection!**

- ▶ Have electrical connection work carried out by correspondingly trained specialists only.
- ▶ Observe applicable federal/national installation codes and regulations.
- ▶ Comply with local workplace safety regulations.
- ▶ For use in potentially explosive atmospheres, observe the information in the device-specific Ex documentation.

**7.2.1 Connecting the remote version****⚠ WARNING****Risk of damaging the electronic components!**

- ▶ Ground the remote version and in doing so connect the sensor and transmitter to the same potential equalization.
- ▶ Only connect the sensor to a transmitter with the same serial number.

The following procedure (in the action sequence given) is recommended for the remote version:

1. Mount the transmitter and sensor.
2. Connect the connecting cable.
3. Connect the transmitter.

**i** The way the transmitter wall holder is connected depends on the measuring device approval and the version of the connecting cable used.

Connection is only possible via terminals:

- For approvals Ex n, Ex tb and cCSAus Div. 1
- If a reinforced connecting cable is used

The connection is via an M12 connector:

- For all other approvals
- If the standard connecting cable is used

Connection to the connection housing of the sensor is always via the terminals (tightening torque for terminals: 1.2 to 1.7 Nm).

### Connecting the sensor connection housing

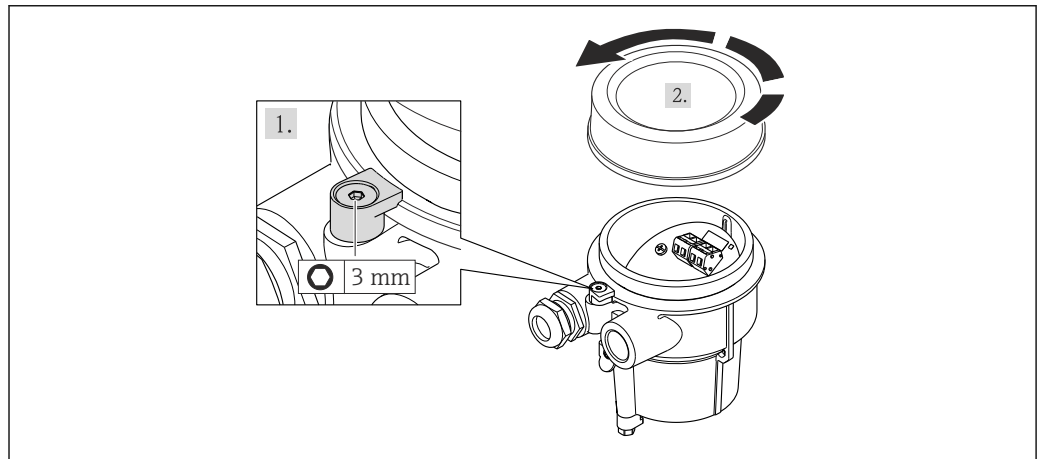

A0020410

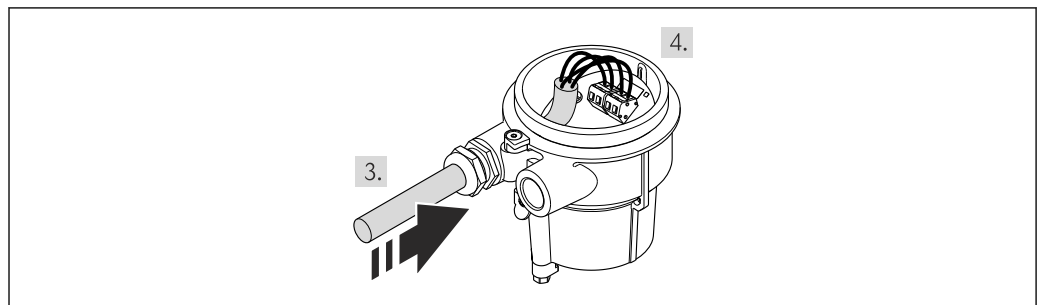

A0020411

1. Loosen the securing clamp.
2. Unscrew the housing cover.
3. Guide the connecting cable through the cable entry and into the connection housing (if using a connecting cable without an M12 device plug, use the shorter stripped end of the connecting cable).

**4. NOTICE****Terminals tightened with an incorrect tightening torque.**

Incorrect connection or damaged terminal.

- ▶ Tighten the terminals with a tightening torque in the 1.2 to 1.7 Nm range.

Wire the connecting cable:

- ↳ Terminal 1 = brown cable
- Terminal 2 = white cable
- Terminal 3 = yellow cable
- Terminal 4 = green cable

- 5. Connect the cable shield via the cable strain relief.

- 6. Reverse the removal procedure to reassemble the transmitter.

**Connection to the wall holder of the transmitter**

*Connecting the transmitter via plug*

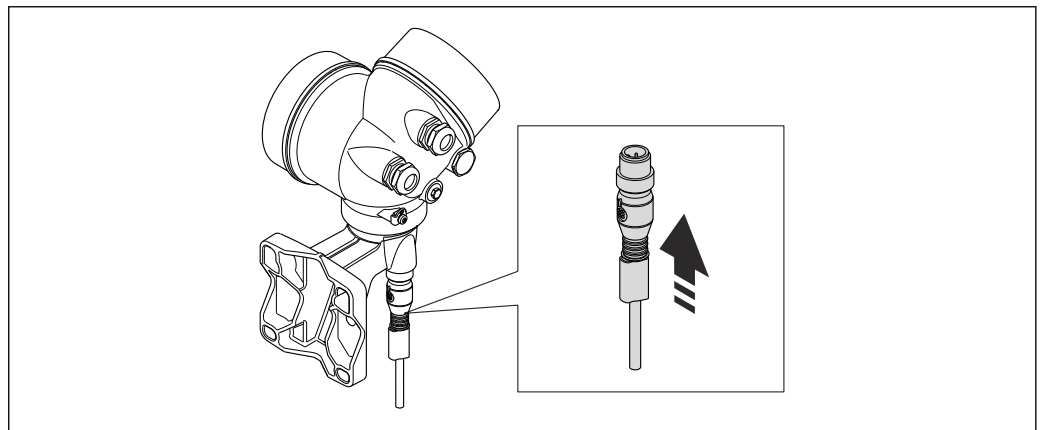

A0020412

- ▶ Connect the plug.

*Connecting the transmitter via terminals*

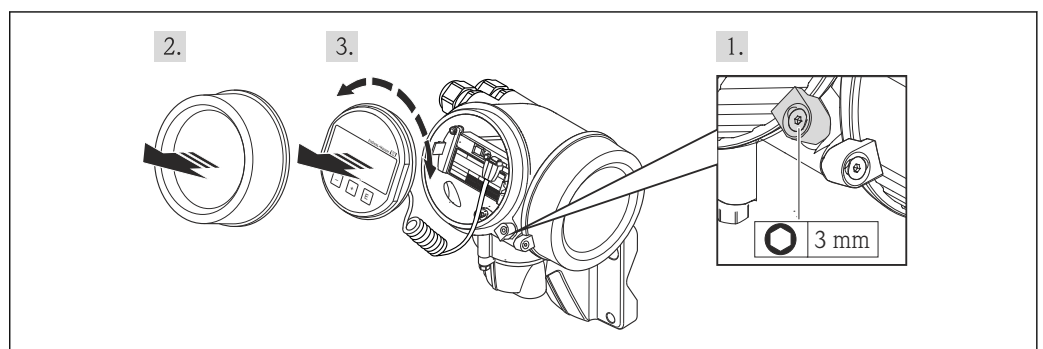

A0020404

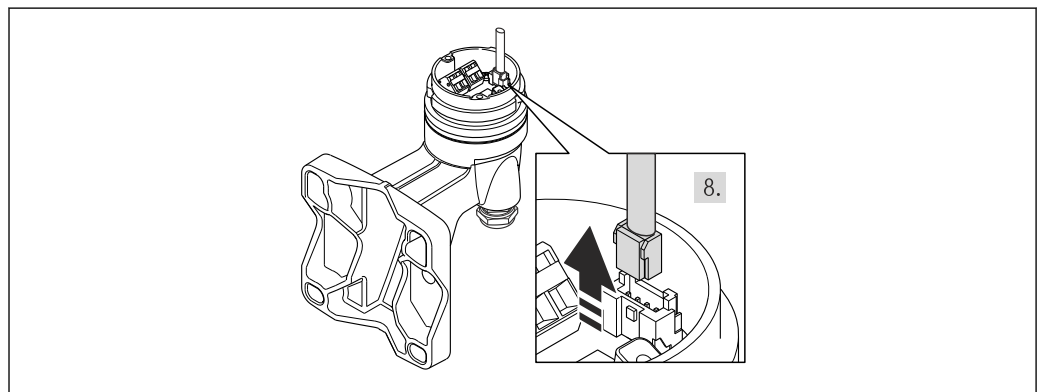
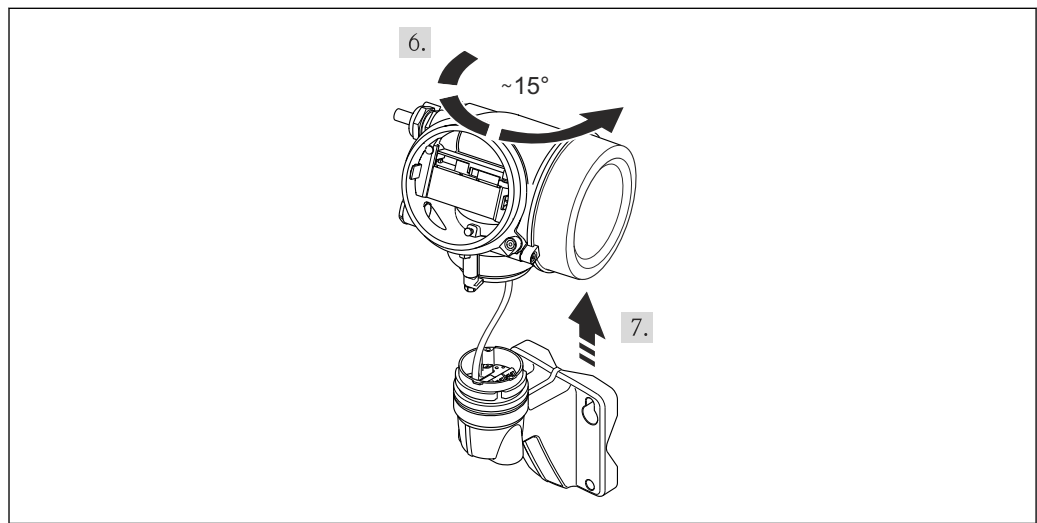
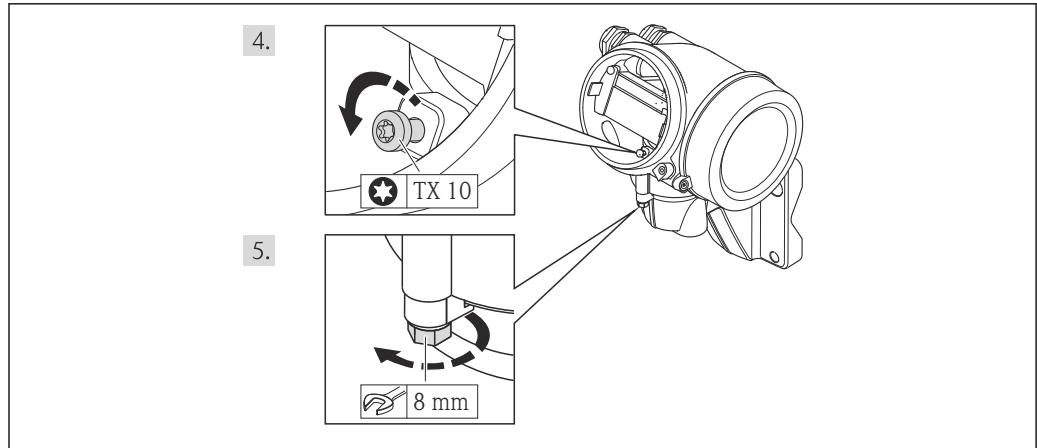

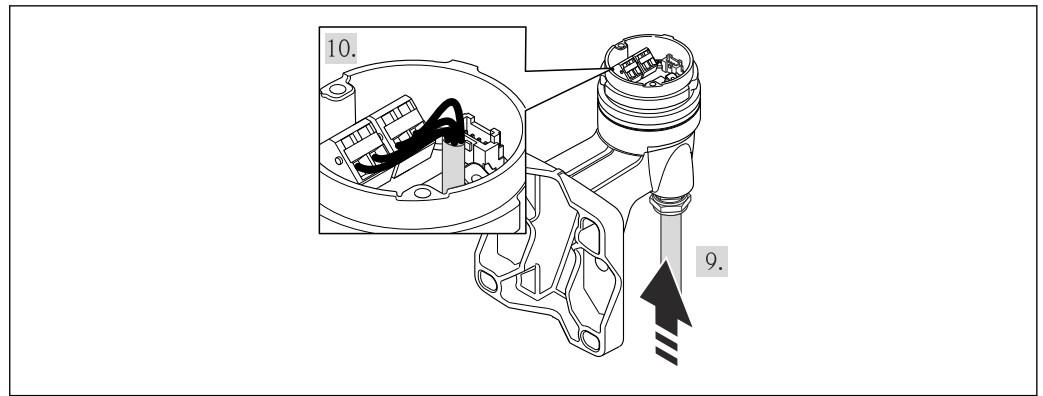

A0020409

1. Loosen the securing clamp of the transmitter housing.
2. Loosen the securing clamp of the electronics compartment cover.
3. Unscrew the electronics compartment cover.
4. Pull out the display module with a gentle rotational movement. To make it easier to access the lock switch, attach the display module to the edge of the electronics compartment.
5. Loosen the locking screw of the transmitter housing.
6. Turn the transmitter housing to the right until the mark and lift it up. The connection board of the wall housing is connected to the electronics board of the transmitter via a signal cable. Pay attention to the signal cable when lifting the transmitter housing!
7. Disconnect the signal cable from the connection board of the wall housing by pressing in the locking clip on the connector.
8. Remove the transmitter housing.
9. Guide the connecting cable through the cable entry and into the connection housing (if using a connecting cable without an M12 device plug, use the shorter stripped end of the connecting cable).
10. Wire the connecting cable:
  - ↳ Terminal 1 = brown cable
  - Terminal 2 = white cable
  - Terminal 3 = yellow cable
  - Terminal 4 = green cable
11. Connect the cable shield via the cable strain relief.
12. Reverse the removal procedure to reassemble the transmitter.

### 7.2.2 Connecting the transmitter

The connection of the transmitter depends on the following order codes:

Connection version: terminals or device plug

### Connection via terminals

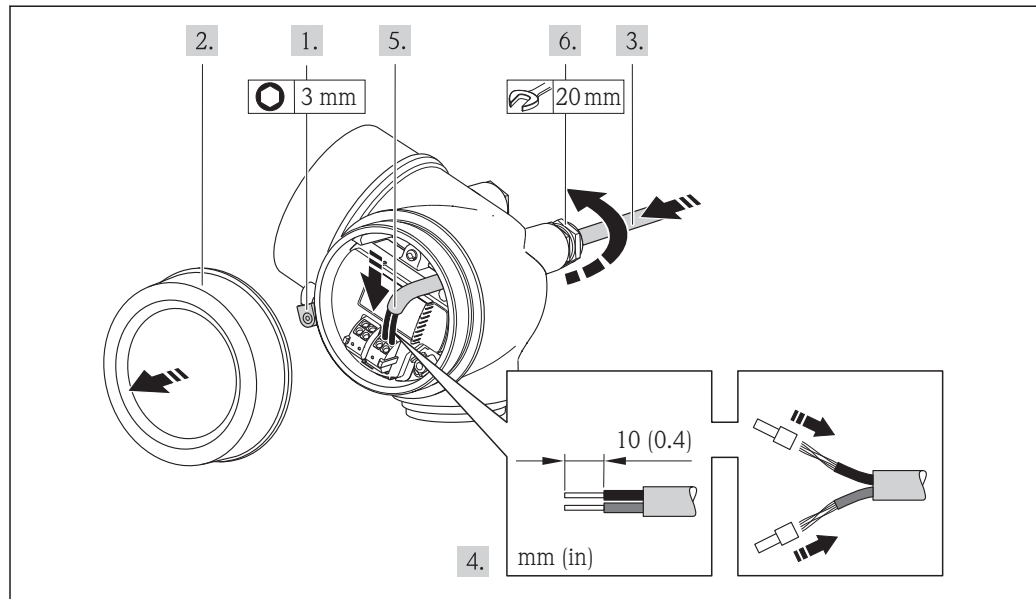

A0013836

1. Loosen the securing clamp of the connection compartment cover.
2. Unscrew the connection compartment cover.
3. Push the cable through the cable entry . To ensure tight sealing, do not remove the sealing ring from the cable entry.
4. Strip the cable and cable ends. In the case of stranded cables, also fit ferrules.
5. Connect the cable in accordance with the terminal assignment .
6. **⚠ WARNING**  
**Housing degree of protection may be voided due to insufficient sealing of the housing.**
  - ▶ Screw in the screw without using any lubricant. The threads on the cover are coated with a dry lubricant.

Reverse the removal procedure to reassemble the transmitter.

### Connection via device plug

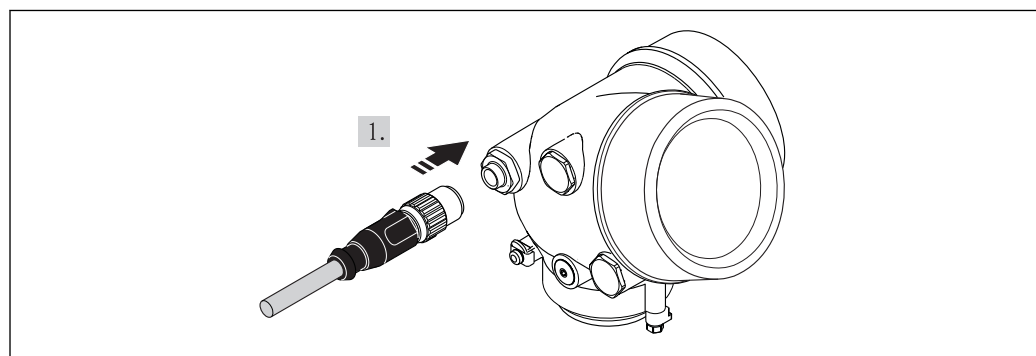

A0019147

- ▶ Plug in the device plug and tighten firmly.



### Removing a cable

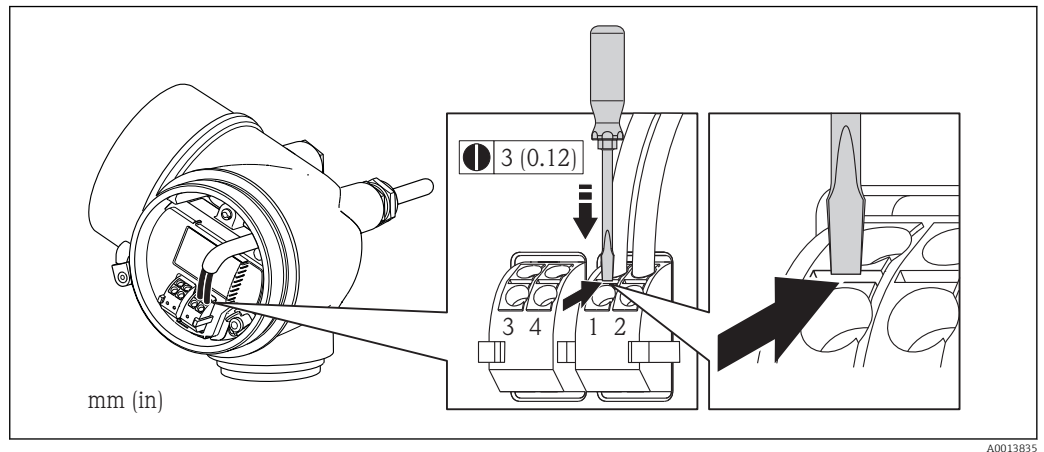

- ▶ To remove a cable from the terminal, use a flat-blade screwdriver to push the slot between the two terminal holes while simultaneously pulling the cable end out of the terminal.

### 7.2.3 Ensuring potential equalization

#### Requirements

Please consider the following to ensure correct measurement:

- Same electrical potential for the fluid and sensor
- Remote version: same electrical potential for the sensor and transmitter
- Company-internal grounding concepts
- Pipe material and grounding



For devices intended for use in hazardous locations, please observe the guidelines in the Ex documentation (XA).

### 7.3 Special connection instructions

#### 7.3.1 Connection examples

##### Pulse/frequency output

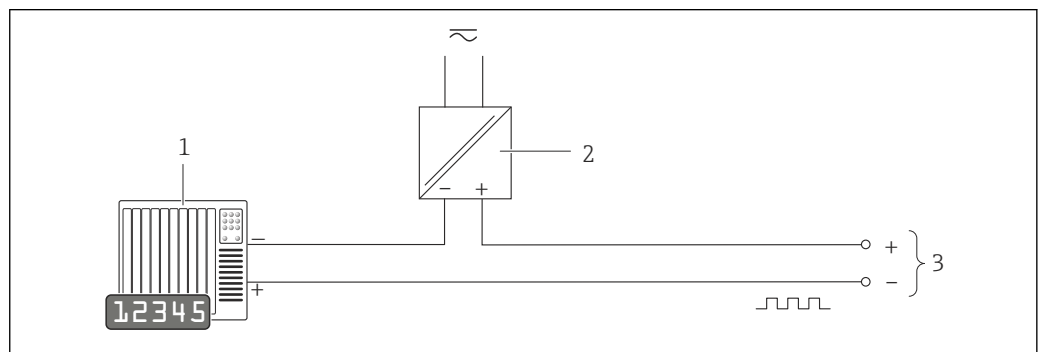

11 Connection example for pulse/frequency output (passive)

- 1 Automation system with pulse/frequency input (e.g. PLC)
- 2 Power supply
- 3 Transmitter: observe input values → 191

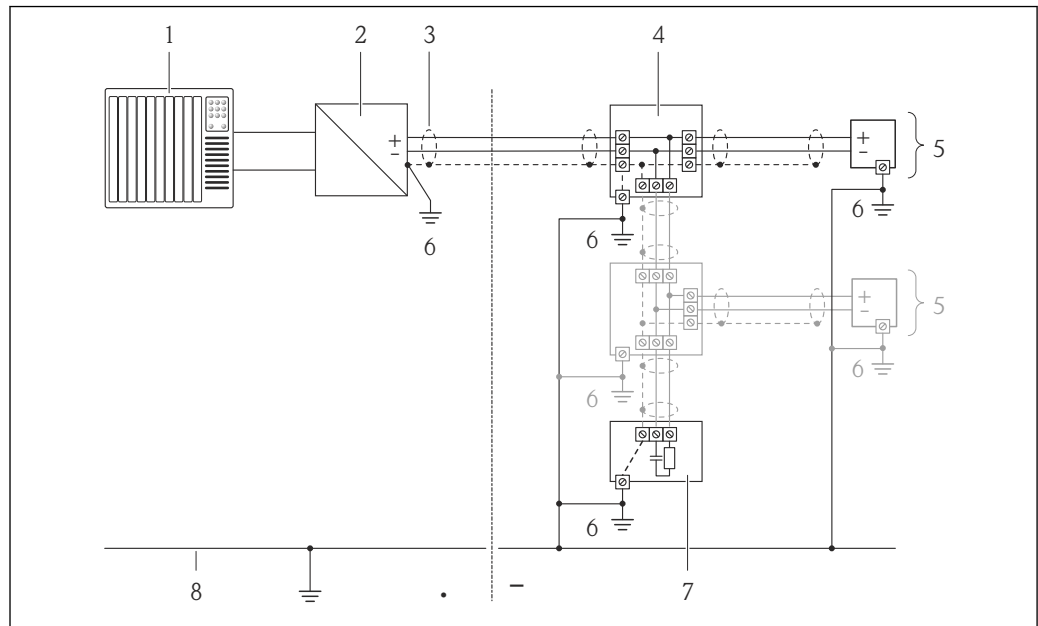
**PROFIBUS-PA**

12 Connection example for PROFIBUS-PA

- 1 Control system (e.g. PLC)
- 2 Segment coupler PROFIBUS DP/PA
- 3 Cable shield
- 4 T-box
- 5 Measuring device
- 6 Local grounding
- 7 Bus terminator
- 8 Potential matching line

## 7.4 Hardware settings

### 7.4.1 Setting the device address

#### PROFIBUS PA

The address must always be configured for a PROFIBUS DP/PA device. The valid address range is between 1 and 126. In a PROFIBUS DP/PA network, each address can only be assigned once. If an address is not configured correctly, the device is not recognized by the master. All measuring devices are delivered from the factory with the device address 126 and with the software addressing method.

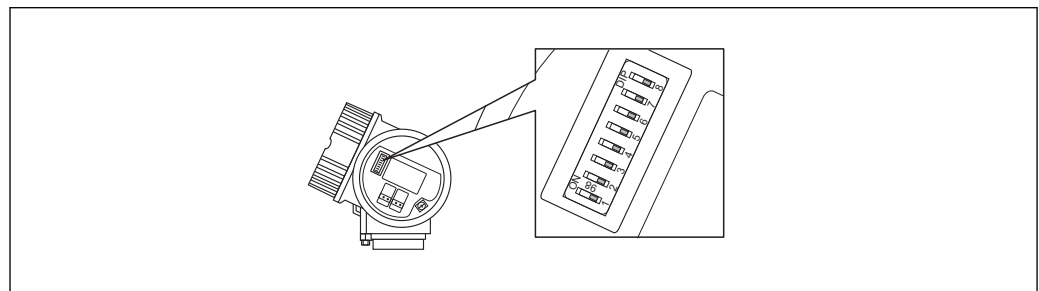

13 Address switch in the connection compartment

*Hardware addressing*

1. Set switch 8 to the "OFF" position.
2. Using switches 1 to 7, set the address as indicated in the table below.

The change of address takes effect after 10 seconds. The device is restarted.

Switch	1	2	3	4	5	6	7
Value in "ON" position	1	2	4	8	16	32	64
Value in "OFF" position	0	0	0	0	0	0	0

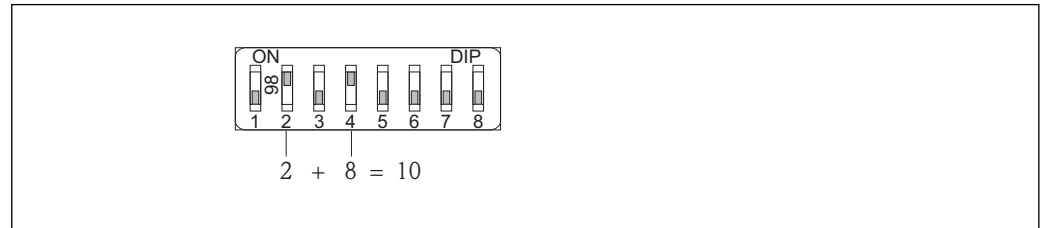

A0015902

14 Example of hardware addressing; switch 8 is set to the "OFF" position; switches 1 to 7 define the address.

*Software addressing*

1. Set switch 8 to "ON".
  - ↳ The device restarts automatically and reports the current address (factory setting: 126).
2. Configure the address via the operating menu: **Setup** menu→**Communication** submenu→**Device address** parameter

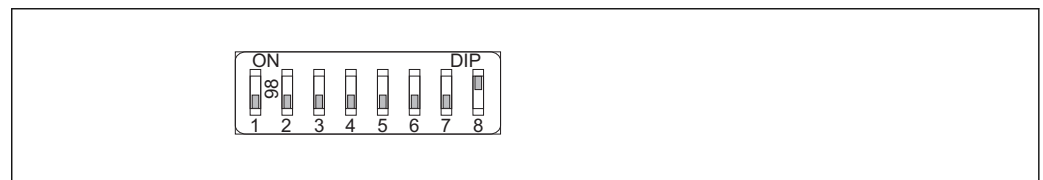

A0015903

15 Example of software addressing; switch 8 is set to the "ON" position; the address is defined in the operating menu ("Setup" menu→"Communication" submenu→"Device address" parameter).

## 7.5 Ensuring the degree of protection

The measuring device fulfills all the requirements for the IP66/67 degree of protection, Type 4X enclosure.

To guarantee IP66/67 degree of protection, Type 4X enclosure, carry out the following steps after the electrical connection:

1. Check that the housing seals are clean and fitted correctly. Dry, clean or replace the seals if necessary.
2. Tighten all housing screws and screw covers.
3. Firmly tighten the cable glands.

- 4. To ensure that moisture does not enter the cable entry, route the cable so that it loops down before the cable entry ("water trap").

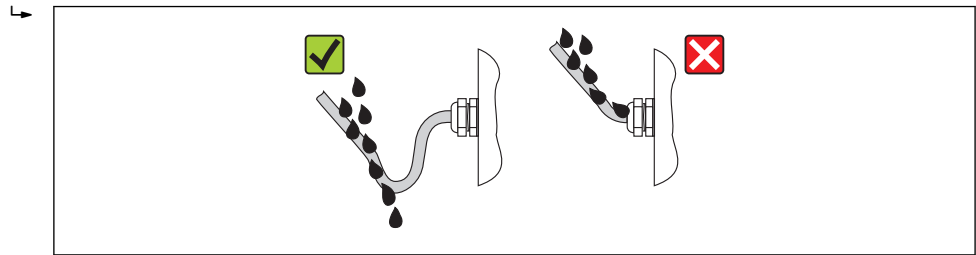

A0013960

- 5. Insert dummy plugs into unused cable entries.

## 7.6 Post-connection check

Are cables or the device undamaged (visual inspection)?	<input type="checkbox"/>
Do the cables comply with the requirements ?	<input type="checkbox"/>
Do the cables have adequate strain relief?	<input type="checkbox"/>
Are all the cable glands installed, firmly tightened and leak-tight? Cable run with "water trap" → 43 ?	<input type="checkbox"/>
Depending on the device version: are all the device plugs firmly tightened ?	<input type="checkbox"/>
Does the supply voltage match the specifications on the transmitter nameplate ?	<input type="checkbox"/>
Is the terminal assignment correct ?	<input type="checkbox"/>
Is the terminal assignment or the pin assignment of the device plug correct?	<input type="checkbox"/>
If supply voltage is present, do values appear on the display module?	<input type="checkbox"/>
Are all housing covers installed and firmly tightened?	<input type="checkbox"/>
Is the securing clamp tightened correctly?	<input type="checkbox"/>

## 8 Operation options

### 8.1 Overview of operating options

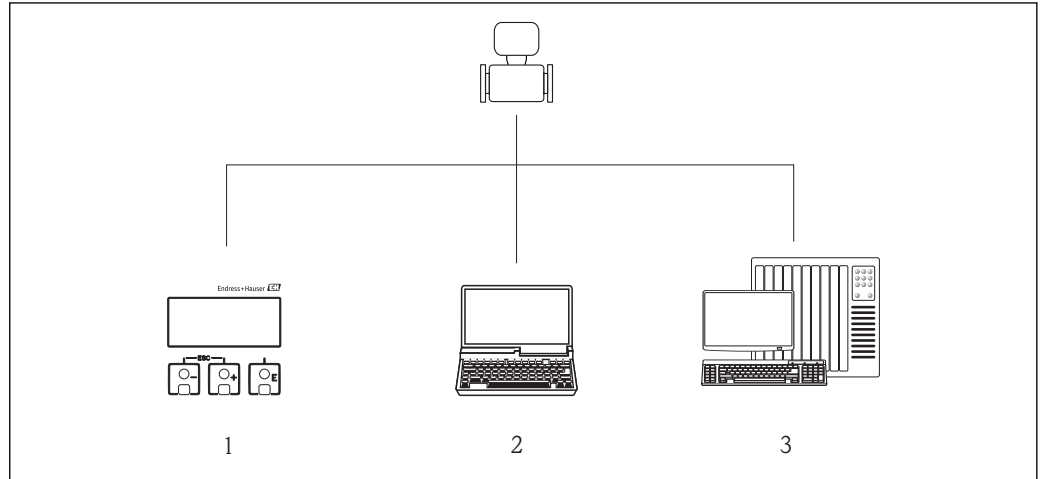

A0019091

- 1 Local operation via display module
- 2 Computer with operating tool (e.g. FieldCare, SIMATIC PDM)
- 3 Automation system (e.g. PLC)

## 8.2 Structure and function of the operating menu

### 8.2.1 Structure of the operating menu

**i** For an overview of the operating menu with menus and parameters

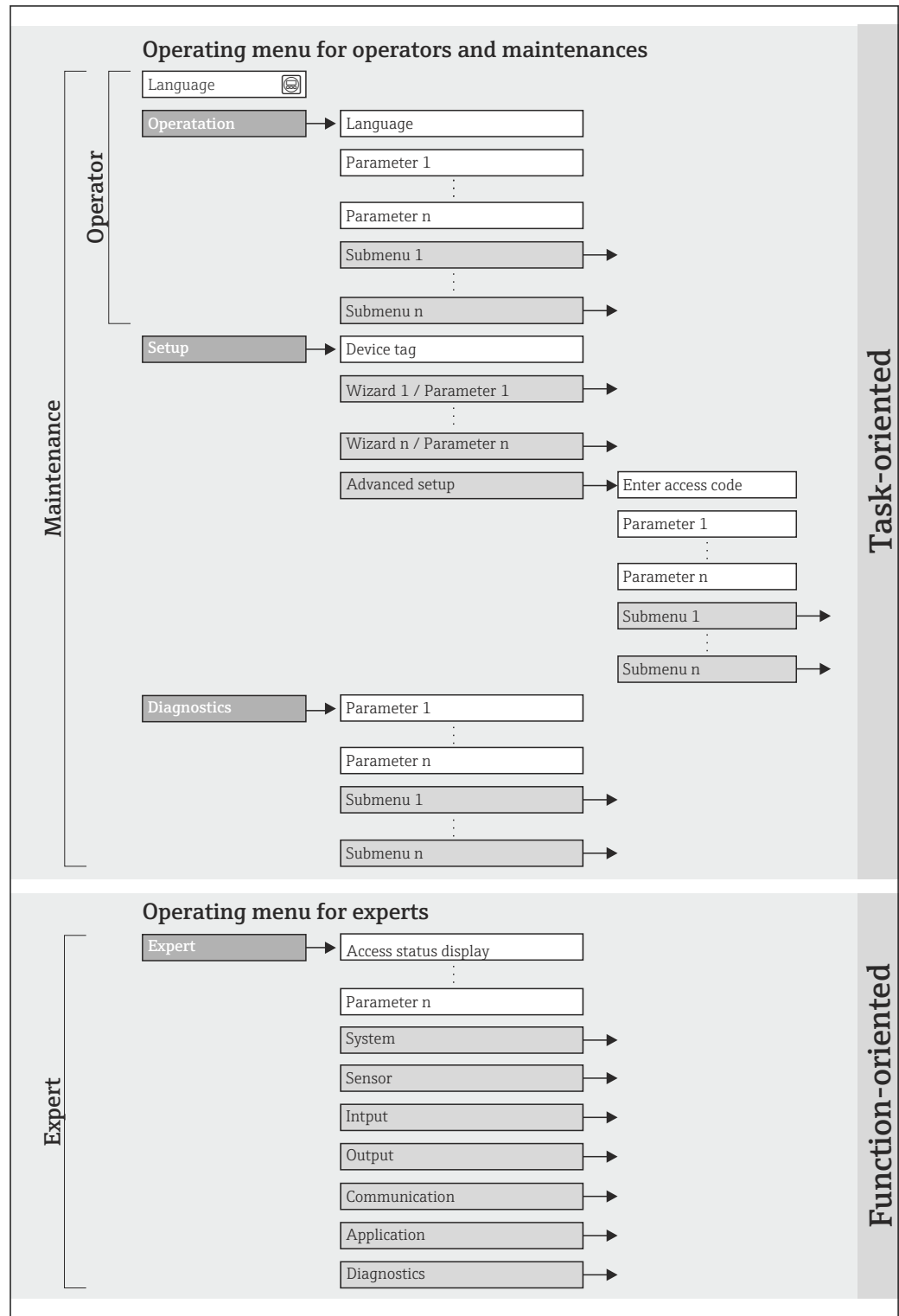

**16** Schematic structure of the operating menu

A0018237-EN

### 8.2.2 Operating philosophy

The individual parts of the operating menu are assigned to certain user roles (operator, maintenance etc.). Each user role contains typical tasks within the device lifecycle.

Menu/parameter		User role and tasks	Content/meaning
Language	task-oriented	<b>Role "Operator", "Maintenance"</b> Tasks during operation: <ul style="list-style-type: none"> <li>▪ Configuring the operational display</li> <li>▪ Reading measured values</li> </ul>	Defining the operating language
Operation			<ul style="list-style-type: none"> <li>▪ Configuring the operational display (e.g. display format, display contrast)</li> <li>▪ Resetting and controlling totalizers</li> </ul>
Setup		<b>"Maintenance" role</b> Commissioning: <ul style="list-style-type: none"> <li>▪ Configuration of the measurement</li> <li>▪ Configuration of the inputs and outputs</li> </ul>	Wizards for fast commissioning: <ul style="list-style-type: none"> <li>▪ Configure the outputs</li> <li>▪ Configuring the operational display</li> <li>▪ Define the output conditioning</li> <li>▪ Set the low flow cut off</li> </ul> Advanced setup <ul style="list-style-type: none"> <li>▪ For more customized configuration of the measurement (adaptation to special measuring conditions)</li> <li>▪ Configuration of totalizers</li> <li>▪ Administration (define access code, reset measuring device)</li> </ul>
Diagnostics		<b>"Maintenance" role</b> Fault elimination: <ul style="list-style-type: none"> <li>▪ Diagnostics and elimination of process and device errors</li> <li>▪ Measured value simulation</li> </ul>	Contains all parameters for error detection and analyzing process and device errors: <ul style="list-style-type: none"> <li>▪ Diagnostic list Contains up to 5 currently pending diagnostic messages.</li> <li>▪ Event logbook Contains up to 20 or 100 (order option "Extended HistoROM") event messages that have occurred.</li> <li>▪ Device information Contains information for identifying the device.</li> <li>▪ Measured values Contains all current measured values.</li> <li>▪ Analog inputs Is used to display the analog input.</li> <li>▪ Data logging (Order option "Extended HistoROM") Storage and visualization of up to 1000 measured values</li> <li>▪ Heartbeat The functionality of the device is checked on demand and the verification results are documented.</li> <li>▪ Simulation Is used to simulate measured values or output values.</li> </ul>
Expert	function-oriented	Tasks that require detailed knowledge of the function of the device: <ul style="list-style-type: none"> <li>▪ Commissioning measurements under difficult conditions</li> <li>▪ Optimal adaptation of the measurement to difficult conditions</li> <li>▪ Detailed configuration of the communication interface</li> <li>▪ Error diagnostics in difficult cases</li> </ul>	Contains all the parameters of the device and makes it possible to access these parameters directly using an access code. The structure of this menu is based on the function blocks of the device: <ul style="list-style-type: none"> <li>▪ System Contains all higher-order device parameters which do not concern the measurement or the communication interface.</li> <li>▪ Sensor Configuration of the measurement.</li> <li>▪ Output Configuration of the pulse/frequency/status output.</li> <li>▪ Communication Configuration of the digital communication interface.</li> <li>▪ Submenus for function blocks (e.g. "Analog Inputs") Configuration of function blocks.</li> <li>▪ Application Configuration of the functions that go beyond the actual measurement (e.g. totalizer).</li> <li>▪ Diagnostics Error detection and analysis of process and device errors and for device simulation and Heartbeat Technology.</li> </ul>

## 8.3 Access to the operating menu via the local display

### 8.3.1 Operational display

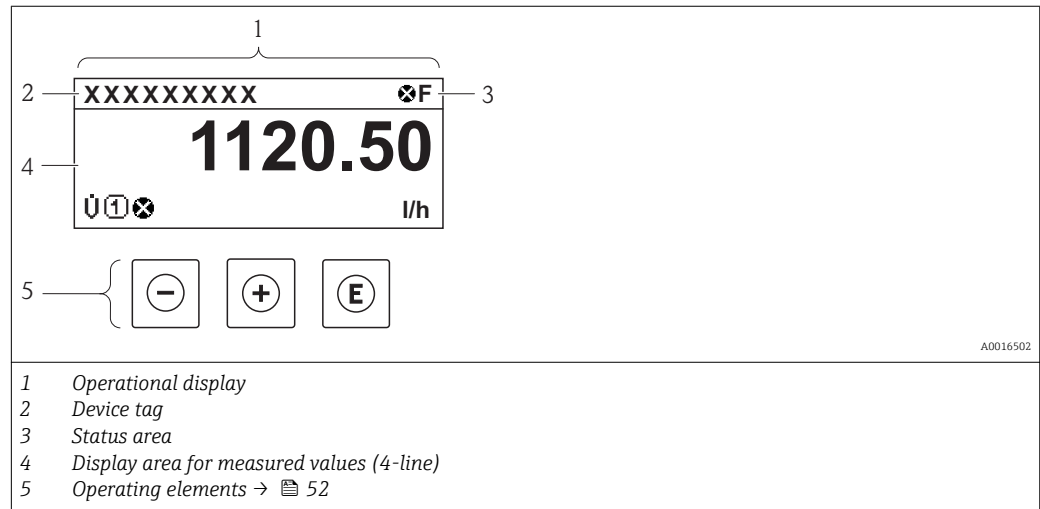

#### Status area

The following symbols appear in the status area of the operational display at the top right:

- Status signals → 137
  - **F**: Failure
  - **C**: Function check
  - **S**: Out of specification
  - **M**: Maintenance required
- Diagnostic behavior → 138
  - : Alarm
  - : Warning
- : Locking (the device is locked via the hardware)
- : Communication (communication via remote operation is active)

#### Display area

In the display area, each measured value is prefaced by certain symbol types for further description:

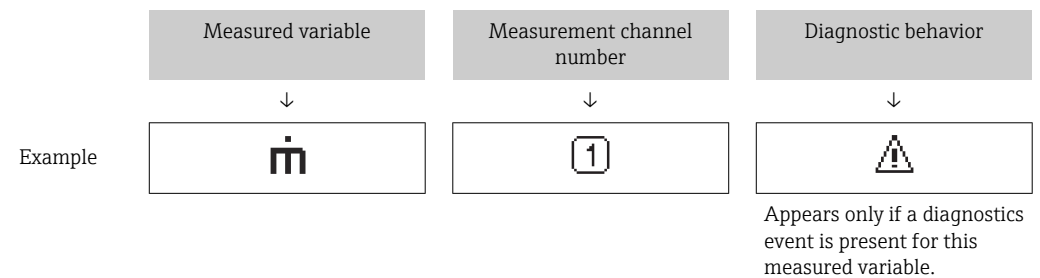

#### Measured variables

Symbol	Meaning
	Volume flow
	Totalizer The measurement channel number indicates which of the three totalizers is displayed.



Measurement channel numbers

Symbol	Meaning
	Measurement channel 1 to 4
The measurement channel number is displayed only if more than one channel is present for the same measured variable type (e.g. totalizer 1-3).	

Diagnostic behavior

The diagnostic behavior pertains to a diagnostic event that is relevant to the displayed measured variable. For information on the symbols → 138

The number and display format of the measured values can be configured via the **"Format display" parameter** → 82. "Operation" menu → Display → Format display

### 8.3.2 Navigation view

In the submenu	In the wizard
<p>1: Navigation view 2: Navigation path to current position 3: Status area 4: Display area for navigation 5: Operating elements →  52</p> <p style="text-align: right;"><small>A0013993-EN</small></p>	<p>1: Navigation view 2: Navigation path to current position 3: Status area 4: Display area for navigation 5: Operating elements →  52</p> <p style="text-align: right;"><small>A0016327-EN</small></p>
<p>1 Navigation view 2 Navigation path to current position 3 Status area 4 Display area for navigation 5 Operating elements →  52</p>	

#### Navigation path



The navigation path - displayed at the top left in the navigation view - consists of the following elements:

	<ul style="list-style-type: none"> <li>In the submenu: Display symbol for menu</li> <li>In the wizard: Display symbol for wizard</li> </ul>	Omission symbol for operating menu levels in between	Name of current <ul style="list-style-type: none"> <li>Submenu</li> <li>Wizard</li> <li>Parameter</li> </ul>
	↓	↓	↓
Examples		/ .. /	Display
		/ .. /	Display

For more information about the menu icons, refer to the "Display area" section → 50





**Status area**

The following appears in the status area of the navigation view in the top right corner:





- Of the submenu
  - The direct access code for the parameter you are navigating to (e.g. 0022-1)
  - If a diagnostic event is present, the diagnostic behavior and status signal
- In the wizard
  - If a diagnostic event is present, the diagnostic behavior and status signal
-  ▪ For information on the diagnostic behavior and status signal →  137
- For information on the function and entry of the direct access code →  55

**Display area**

*Menus*

Symbol	Meaning
	<b>Operation</b> Appears: <ul style="list-style-type: none"> <li>▪ In the menu next to the "Operation" selection</li> <li>▪ At the left in the navigation path in the "Operation" menu</li> </ul>
	<b>Setup</b> Appears: <ul style="list-style-type: none"> <li>▪ In the menu next to the "Setup" selection</li> <li>▪ At the left in the navigation path in the "Setup" menu</li> </ul>
	<b>Diagnostics</b> Appears: <ul style="list-style-type: none"> <li>▪ In the menu next to the "Diagnostics" selection</li> <li>▪ At the left in the navigation path in the "Diagnostics" menu</li> </ul>
	<b>Expert</b> Appears: <ul style="list-style-type: none"> <li>▪ In the menu next to the "Expert" selection</li> <li>▪ At the left in the navigation path in the "Expert" menu</li> </ul>



*Submenus, wizards, parameters*

Symbol	Meaning
	Submenu
	Wizard
	Parameters within a wizard  No display symbol exists for parameters in submenus.

*Locking*

Symbol	Meaning
	<b>Parameter locked</b> When displayed in front of a parameter name, indicates that the parameter is locked. <ul style="list-style-type: none"> <li>▪ By a user-specific access code</li> <li>▪ By the hardware write protection switch</li> </ul>

*Wizard operation*

Symbol	Meaning
	Switches to the previous parameter.
	Confirms the parameter value and switches to the next parameter.
	Opens the editing view of the parameter.

### 8.3.3 Editing view

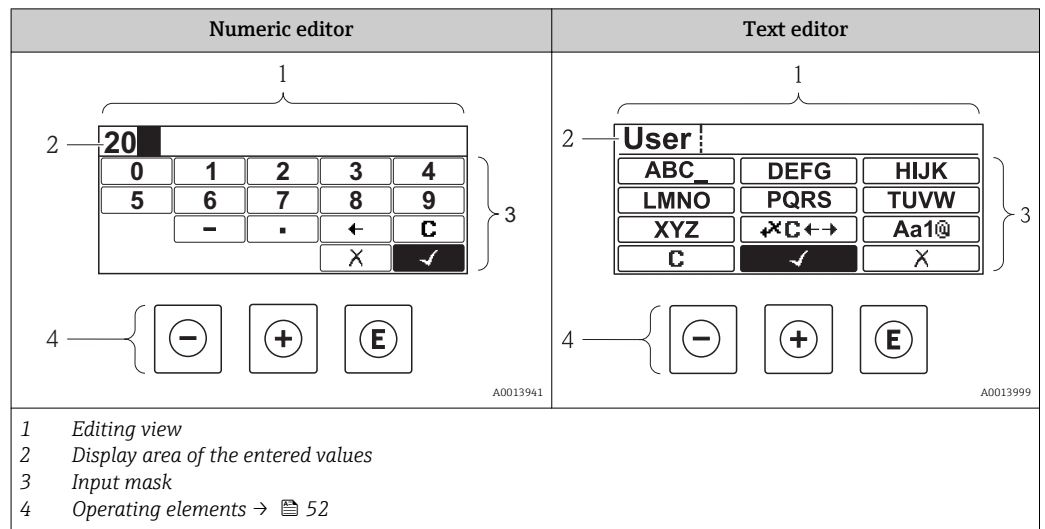

#### Input mask









The following input symbols are available in the input mask of the numeric and text editor:

##### Numeric editor





Symbol	Meaning
0 ... 9	Selection of numbers from 0 to 9.
.	Inserts decimal separator at the input position.
-	Inserts minus sign at the input position.
✓	Confirms selection.
←	Moves the input position one position to the left.
X	Exits the input without applying the changes.
C	Clears all entered characters.

##### Text editor



Symbol	Meaning
Aa1@ ... XYZ	Toggle <ul style="list-style-type: none"> <li>Between upper-case and lower-case letters</li> <li>For entering numbers</li> <li>For entering special characters</li> </ul>
ABC_ ... XYZ	Selection of letters from A to Z.

 	Selection of letters from a to z.
 	Selection of special characters.
	Confirms selection.
	Switches to the selection of the correction tools.
	Exits the input without applying the changes.
	Clears all entered characters.

Correction symbols under 

Symbol	Meaning
	Clears all entered characters.
	Moves the input position one position to the right.
	Moves the input position one position to the left.
	Deletes one character immediately to the left of the input position.

### 8.3.4 Operating elements

Key	Meaning
	<p><b>Minus key</b></p> <p><i>In a menu, submenu</i>                      Moves the selection bar upwards in a choose list.</p> <p><i>With a Wizard</i>                      Confirms the parameter value and goes to the previous parameter.</p> <p><i>With a text and numeric editor</i>                      In the input mask, moves the selection bar to the left (backwards).</p>
	<p><b>Plus key</b></p> <p><i>In a menu, submenu</i>                      Moves the selection bar downwards in a choose list.</p> <p><i>With a Wizard</i>                      Confirms the parameter value and goes to the next parameter.</p> <p><i>With a text and numeric editor</i>                      Moves the selection bar to the right (forwards) in an input screen.</p>

Key	Meaning
Ⓔ	<p><b>Enter key</b></p> <p><i>For operational display</i></p> <ul style="list-style-type: none"> <li>▪ Pressing the key briefly opens the operating menu.</li> <li>▪ Pressing the key for 2 s opens the context menu.</li> </ul> <p><i>In a menu, submenu</i></p> <ul style="list-style-type: none"> <li>▪ Pressing the key briefly:                             <ul style="list-style-type: none"> <li>- Opens the selected menu, submenu or parameter.</li> <li>- Starts the wizard.</li> <li>- If help text is open, closes the help text of the parameter.</li> </ul> </li> <li>▪ Pressing the key for 2 s for parameter:                             <ul style="list-style-type: none"> <li>- If present, opens the help text for the function of the parameter.</li> </ul> </li> </ul> <p><i>With a Wizard</i></p> <p>Opens the editing view of the parameter.</p> <p><i>With a text and numeric editor</i></p> <ul style="list-style-type: none"> <li>▪ Pressing the key briefly:                             <ul style="list-style-type: none"> <li>- Opens the selected group.</li> <li>- Carries out the selected action.</li> </ul> </li> <li>▪ Pressing the key for 2 s confirms the edited parameter value.</li> </ul>
⊖ + ⊕	<p><b>Escape key combination (press keys simultaneously)</b></p> <p><i>In a menu, submenu</i></p> <ul style="list-style-type: none"> <li>▪ Pressing the key briefly:                             <ul style="list-style-type: none"> <li>- Exits the current menu level and takes you to the next higher level.</li> <li>- If help text is open, closes the help text of the parameter.</li> </ul> </li> <li>▪ Pressing the key for 2 s returns you to the operational display ("home position").</li> </ul> <p><i>With a Wizard</i></p> <p>Exits the wizard and takes you to the next higher level.</p> <p><i>With a text and numeric editor</i></p> <p>Closes the text or numeric editor without applying changes.</p>
⊖ + Ⓔ	<p><b>Minus/Enter key combination (press the keys simultaneously)</b></p> <p>Reduces the contrast (brighter setting).</p>
⊕ + Ⓔ	<p><b>Plus/Enter key combination (press and hold down the keys simultaneously)</b></p> <p>Increases the contrast (darker setting).</p>
⊖ + ⊕ + Ⓔ	<p><b>Minus/Plus/Enter key combination (press the keys simultaneously)</b></p> <p><i>For operational display</i></p> <p>Enables or disables the keypad lock (only SD02 display module).</p>

### 8.3.5 Opening the context menu

Using the context menu, the user can call up the following menus quickly and directly from the operational display:

- Setup
- Conf. backup disp.
- Simulation

#### Calling up and closing the context menu

The user is in the operational display.

1. Press Ⓔ for 2 s.
  - ↳ The context menu opens.

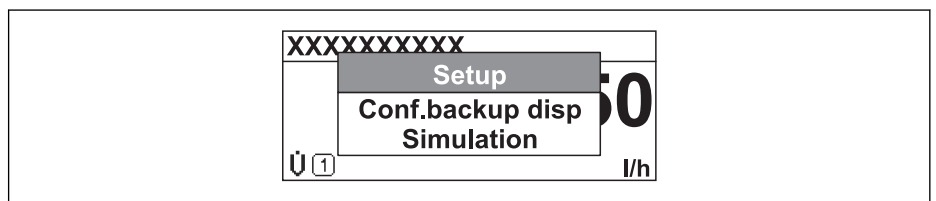

A0016326-EN

2. Press  $\square$  +  $\boxplus$  simultaneously.
  - ↳ The context menu is closed and the operational display appears.

**Calling up the menu via the context menu**

1. Open the context menu.
2. Press  $\boxplus$  to navigate to the desired menu.
3. Press  $\boxtimes$  to confirm the selection.
  - ↳ The selected menu opens.

### 8.3.6 Navigating and selecting from list

Different operating elements are used to navigate through the operating menu. The navigation path is displayed on the left in the header. Icons are displayed in front of the individual menus. These icons are also shown in the header during navigation.

 For an explanation of the navigation view with symbols and operating elements →  49

**Example: Setting the number of displayed measured values to "2 values"**

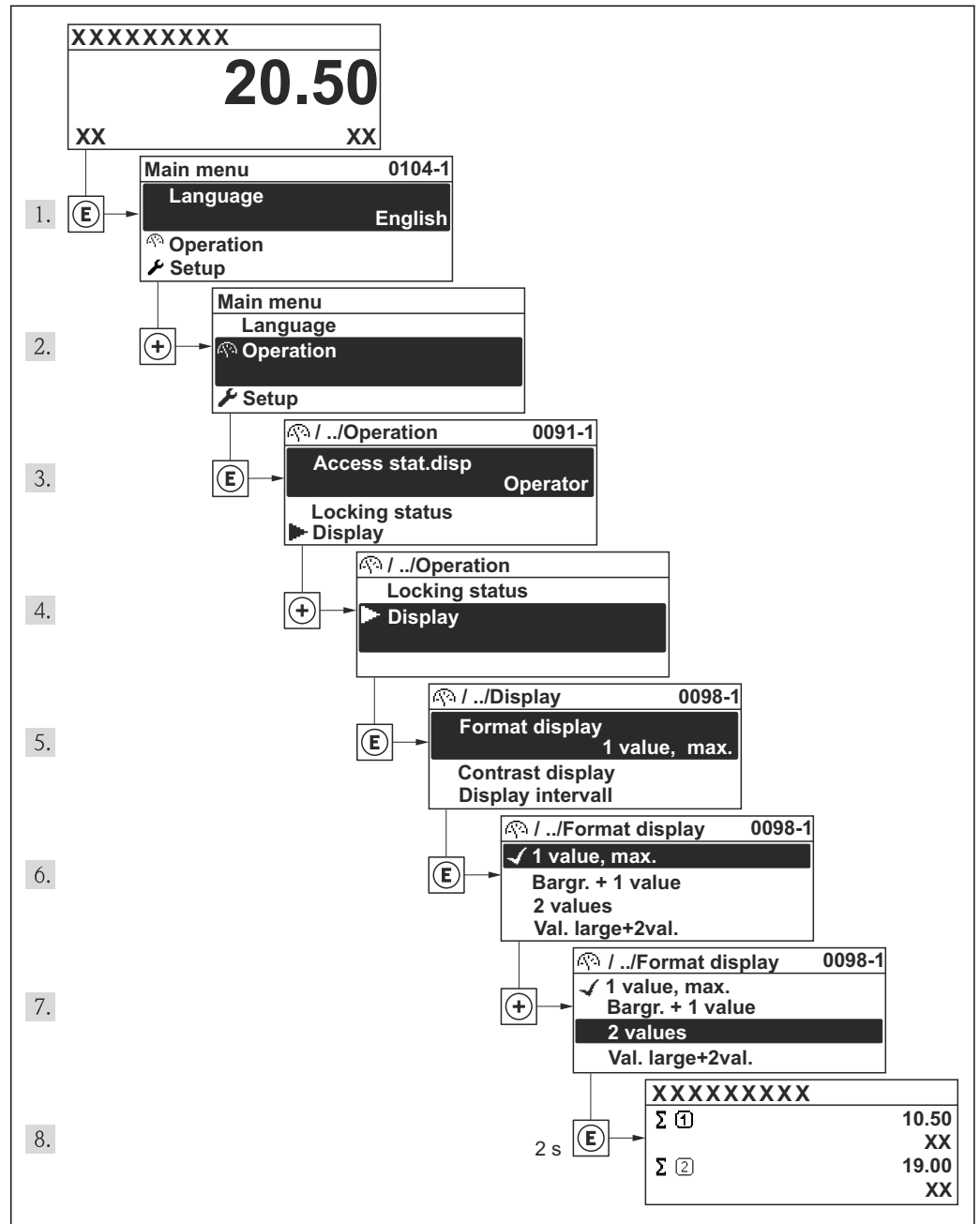

A0014010-EN

### 8.3.7 Calling the parameter directly

A parameter number is assigned to every parameter to be able to access a parameter directly via the onsite display. Entering this access code in the **Direct access** parameter calls up the desired parameter directly.

#### Navigation path

"Expert" menu → Direct access

The direct access code consists of a 4-digit number and the channel number, which identifies the channel of a process variable: e.g. 0914-1. In the navigation view, this appears on the right-hand side in the header of the selected parameter.

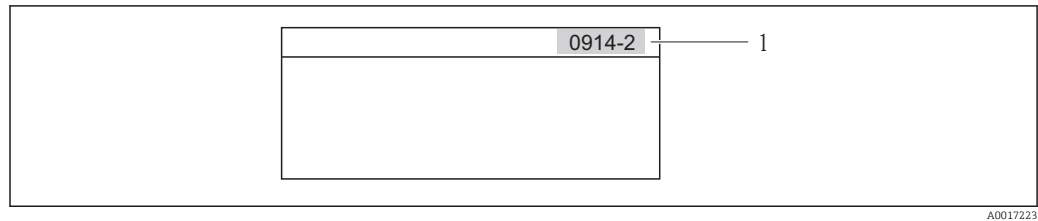

A0017223

1 Direct access code

Note the following when entering the direct access code:

- The leading zeros in the direct access code do not have to be entered.  
Example: Input of "914" instead of "0914"
- If no channel number is entered, channel 1 is jumped to automatically.  
Example: Input of "0914" → Parameter **Totalizer 1**
- If a different channel is jumped to: Enter the direct access code with the corresponding channel number.  
Example: Input of "0914-2" → Parameter **Totalizer 2**



For the direct access codes of the individual parameters

### 8.3.8 Calling up help text

For some parameters, help texts exist, which the user can call up from the navigation view. These briefly describe the function of the parameter and thus support fast and reliable commissioning.

#### Calling up and closing the help text

The user is in the navigation view and the selection bar is on a parameter.

1. Press for 2 s.
  - ↳ The help text for the selected parameter opens.

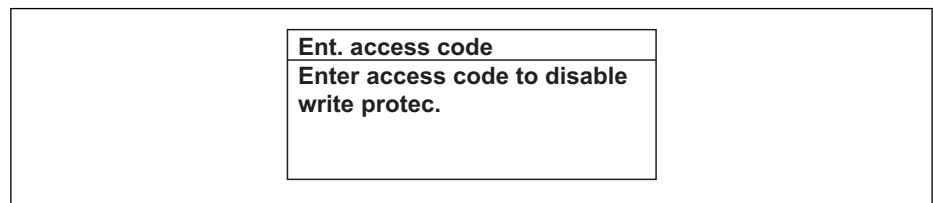

A0014002-EN

17 Example: Help text for parameter "Enter access code"

2. Press + simultaneously.
  - ↳ The help text is closed.



### 8.3.9 Changing the parameters

**i** For a description of the editing display - consisting of text editor and numeric editor - with symbols → 51, for a description of the operating elements → 52

**Example:** Changing the tag name in the "Tag description" parameter from 001-FT-101 to 001-FT-102

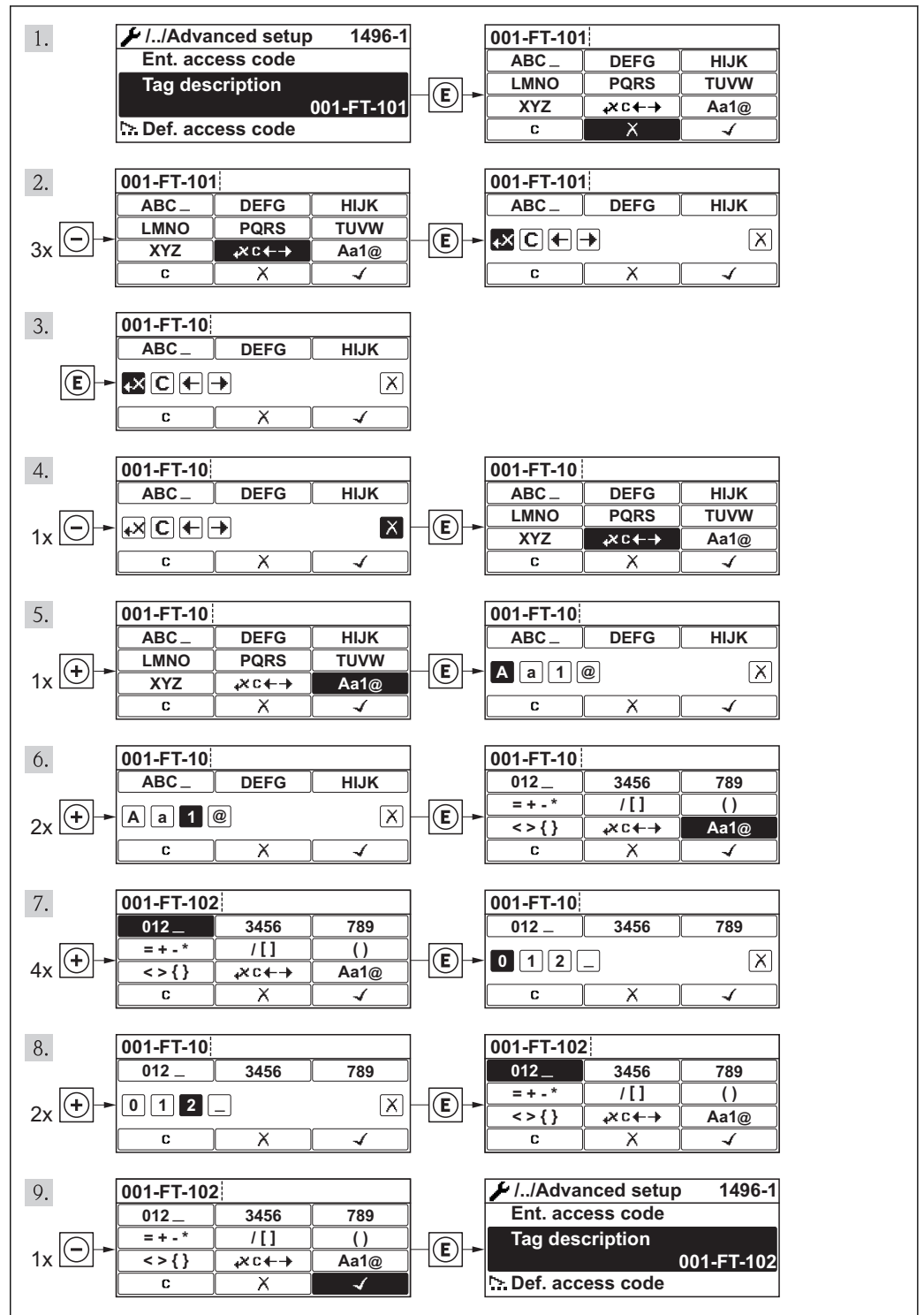

### 8.3.10 User roles and related access authorization

The two user roles "Operator" and "Maintenance" have different write access to the parameters if the customer defines a user-specific access code. This protects the device configuration via the local display from unauthorized access .

*Access authorization to parameters*

User role	Read access		Write access	
	Without access code (from the factory)	With access code	Without access code (from the factory)	With access code
Operator	✓	✓	✓	-- 1)
Maintenance	✓	✓	✓	✓

- 1) Despite the defined access code, certain parameters can always be modified and thus are excepted from the write protection, as they do not affect the measurement. Refer to the "Write protection via access code" section



If an incorrect access code is entered, the user obtains the access rights of the "Operator" role.

 The user role with which the user is currently logged on is indicated by the **Access status display** parameter. Navigation path: Operation → Access status display

### 8.3.11 Disabling write protection via access code

If the -symbol appears on the local display in front of a parameter, the parameter is write-protected by a user-specific access code and its value cannot be changed at the moment using the local display .

The locking of the write access via local operation can be disabled by entering the customer-defined access code via the respective access option.

1. After you press , the input prompt for the access code appears.
2. Enter the access code.
  - ↳ The -symbol in front of the parameters disappears; all previously write-protected parameters are now re-enabled.

### 8.3.12 Enabling and disabling the keypad lock



The keypad lock makes it possible to block access to the entire operating menu via local operation. As a result, it is no longer possible to navigate through the operating menu or change the values of individual parameters. Users can only read the measured values on the operational display.

#### Local operation with mechanical push buttons (display module SD02)

 Display module SD02: order characteristic "Display; Operation", option C



The keypad lock is switched on and off in the same way:

*Switching on the keypad lock*

- ▶ The device is in the measured value display. Press the  +  +  keys simultaneously.
  - ↳ The message **Keylock on** appears on the display: The keypad lock is switched on.

 If the user attempts to access the operating menu while the keypad lock is active, the message **Keylock on** appears.

*Switching off the keypad lock*

- ▶ The keypad lock is switched on.  
Press the  +  +  keys simultaneously.
  - ↳ The message **Keylock off** appears on the display: The keypad lock is switched off.

**Local operation with touch control (display module SD03)**

 Display module SD03: Order characteristic "Display; Operation", option **E**

The keypad lock is switched on and off via the context menu.

*Switching on the keypad lock*

The keypad lock is switched on automatically:

- Each time the device is restarted.
- If the device has not been operated for longer than one minute in the measured value display.

1. The device is in the measured value display.  
Press the  key for longer than 2 seconds.
  - ↳ A context menu appears.
2. In the context menu, select the **Keylock on** option.
  - ↳ The keypad lock is switched on.

 If the user attempts to access the operating menu while the keypad lock is active, the message **Keylock on** appears.

*Switching off the keypad lock*

1. The keypad lock is switched on.  
Press the  key for longer than 2 seconds.
  - ↳ A context menu appears.
2. In the context menu, select the **Keylock off** option.
  - ↳ The keypad lock is switched off.

## 8.4 Access to the operating menu via the operating tool

The structure of the operating menu in the operating tools is the same as for operation via the local display.

### 8.4.1 Connecting the operating tool

**Via PROFIBUS PA network**

This communication interface is available in device versions with PROFIBUS PA.

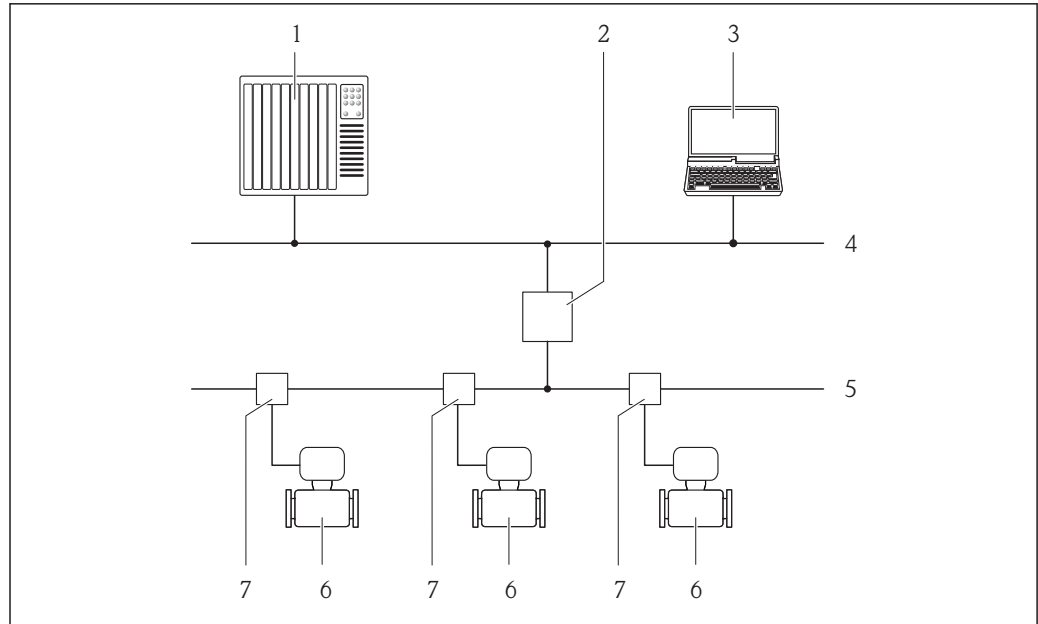

A0019013

18 Options for remote operation via PROFIBUS PA network

- 1 Automation system
- 2 Segment coupler PROFIBUS DP/PA
- 3 Computer with PROFIBUS network card
- 4 PROFIBUS DP network
- 5 PROFIBUS PA network
- 6 Measuring device
- 7 T-box

**Via service interface (CDI)**

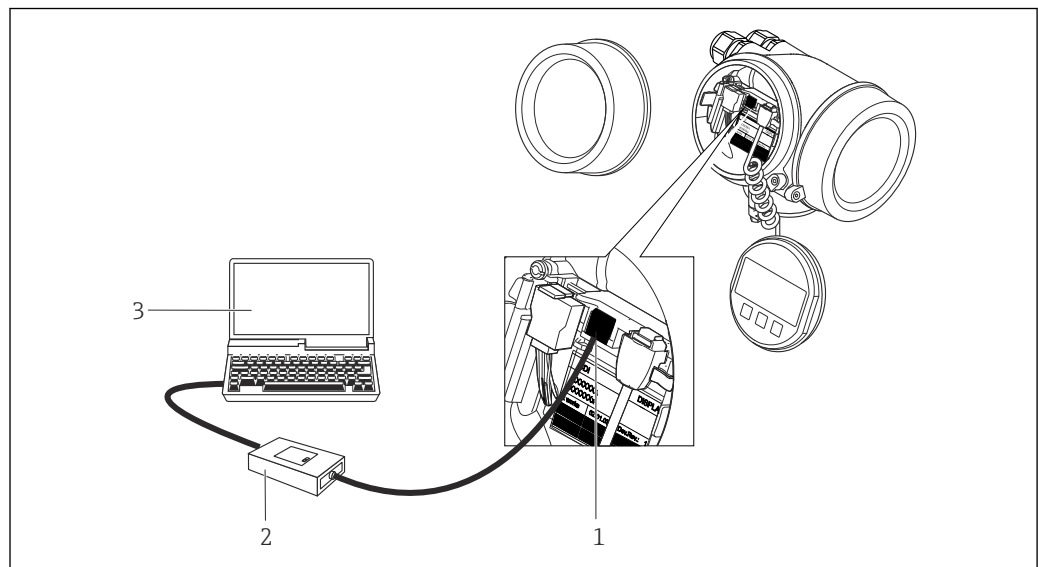

A0020545

- 1 Service interface (CDI = Endress+Hauser Common Data Interface) of the measuring device
- 2 Commubox FXA291
- 3 Computer with "FieldCare" operating tool with COM DTM "CDI Communication FXA291"

## 8.4.2 FieldCare

### Function scope

FDT-based plant asset management tool from Endress+Hauser. It can configure all smart field devices in a system and helps you manage them. By using the status information, it is also a simple but effective way of checking their status and condition.

Access is via:

- PROFIBUS PA protocol →  18,  60
- Service interface CDI →  60

Typical functions:

- Configuring parameters of transmitters
- Loading and saving device data (upload/download)
- Documentation of the measuring point
- Visualization of the measured value memory (line recorder) and event logbook



For additional information about FieldCare, see Operating Instructions BA00027S and BA00059S

### Source for device description files

See information →  63

### Establishing a connection



For additional information, see Operating Instructions BA00027S and BA00059S

User interface

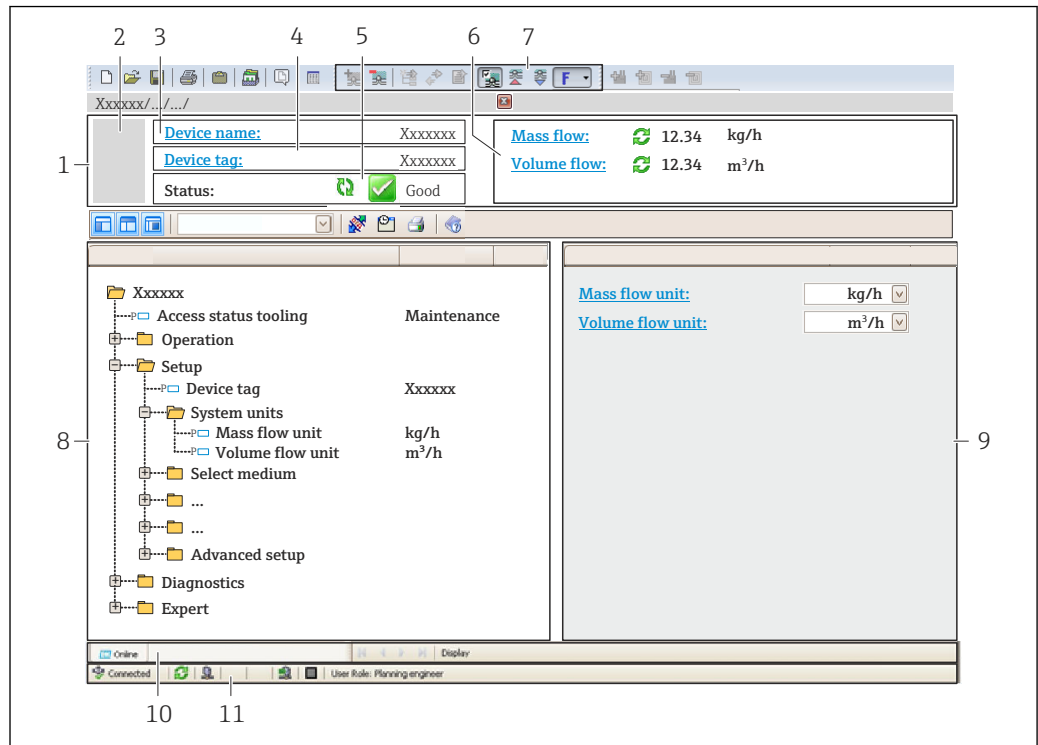

A0021051-EN

- 1 Header
- 2 Picture of device
- 3 Device name
- 4 Tag name
- 5 Status area with status signal
- 6 Display area for current measured values
- 7 Edit toolbar with additional functions such as save/restore, event list and create documentation
- 8 Navigation area with operating menu structure
- 9 Working area
- 10 Range of action
- 11 Status area

### 8.4.3 SIMATIC PDM

#### Function scope

SIMATIC PDM is a standardized, manufacturer-independent program from Siemens for the operation, configuration, maintenance and diagnosis of intelligent field devices via PROFIBUS PA protocol.

#### Source for device description files

See data → 63

## 9 System integration

### 9.1 Overview of device description files

#### 9.1.1 Current version data for the device

Firmware version	01.01.00	<ul style="list-style-type: none"> <li>▪ On the title page of the Operating instructions</li> <li>▪ On transmitter nameplate</li> <li>▪ <b>Firmware version</b> parameter "Diagnostics" menu → Device information → Firmware version</li> </ul>
Release date of firmware version	10.2014	---
Manufacturer ID	0x11	<b>Manufacturer ID</b> parameter "Diagnostics" menu → Device information → Manufacturer ID
Device type code	0x1564	<b>Device type</b> parameter "Diagnostics" menu → Device information → Device type
Profile version	3.02	---



For an overview of the different firmware versions for the device → 176

#### 9.1.2 Operating tools

The suitable device description file for the individual operating tools is listed in the table below, along with information on where the file can be acquired.

Operating tool via PROFIBUS protocol	Sources for obtaining device descriptions
FieldCare	<ul style="list-style-type: none"> <li>▪ <a href="http://www.endress.com">www.endress.com</a> → Download Area</li> <li>▪ CD-ROM (contact Endress+Hauser)</li> <li>▪ DVD (contact Endress+Hauser)</li> </ul>
SIMATIC PDM (Siemens)	<a href="http://www.endress.com">www.endress.com</a> → Download Area

## 9.2 Device master file (GSD)

In order to integrate field devices into a bus system, the PROFIBUS system needs a description of the device parameters, such as output data, input data, data format, data volume and supported transmission rate.

These data are available in the device master file (GSD) which is provided to the PROFIBUS Master when the communication system is commissioned. In addition device bit maps, which appear as icons in the network structure, can also be integrated.

With the Profile 3.0 device master file (GSD) it is possible to exchange field devices made by different manufacturers without having to reconfigure.

Generally speaking two different GSD versions are possible with Profile 3.0 and higher.



- Before configuring, the user must decide which GSD should be used to operate the system.
- The setting can be changed via a Class 2 master.

### 9.2.1 Manufacturer-specific GSD

This GSD guarantees the unrestricted functionality of the measuring device. Device-specific process parameters and functions are therefore available.

Manufacturer-specific GSD	ID number	File name
PROFIBUS PA	0x1564	EH3x1564.gsd

The fact that the manufacturer-specific GSD should be used is specified in the **Ident number selector** parameter by selecting the **Manufacturer** option.



Where to acquire the manufacturer-specific GSD:

[www.endress.com](http://www.endress.com) → Download Area

### 9.2.2 Profile GSD

Differs in terms of the number of Analog Input blocks (AI) and the measured values. If a system is configured with a Profile GSD, it is possible to exchange devices made by different manufacturers. However, it is essential to ensure that the order of the cyclic process values is correct.

ID number	Supported blocks	Supported channels
0x9740	<ul style="list-style-type: none"> <li>■ 1 Analog Input</li> <li>■ 1 Totalizer</li> </ul>	<ul style="list-style-type: none"> <li>■ Channel Analog Input: volume flow</li> <li>■ Channel totalizer: volume flow</li> </ul>
0x9741	<ul style="list-style-type: none"> <li>■ 2 Analog Input</li> <li>■ 1 Totalizer</li> </ul>	<ul style="list-style-type: none"> <li>■ Channel Analog Input 1: volume flow</li> <li>■ Channel Analog Input 2: mass flow</li> <li>■ Channel totalizer: volume flow</li> </ul>
0x9742	<ul style="list-style-type: none"> <li>■ 3 Analog Input</li> <li>■ 1 Totalizer</li> </ul>	<ul style="list-style-type: none"> <li>■ Channel Analog Input 1: volume flow</li> <li>■ Channel Analog Input 2: mass flow</li> <li>■ Channel Analog Input 3: corrected volume flow</li> <li>■ Channel totalizer: volume flow</li> </ul>

The Profile GSD that is to be used is specified in the **Ident number selector** parameter by selecting the **Profile 0x9740** option, **Profile 0x9741** option or **Profile 0x9742** option.

### 9.2.3 Compatibility with other Endress+Hauser measuring devices

The Prowirl 200 PROFIBUS PA guarantees compatibility during cyclic data exchange with the automation system (Class 1 master) for the following measuring devices:

- Prowirl 72 PROFIBUS PA (Profile version 3.0, ID number 0x153B)
- Prowirl 73 PROFIBUS PA (Profile version 3.0, ID number 0x153C)

It is possible to replace these measuring devices with a Prowirl 200 PROFIBUS PA without the need to reconfigure the PROFIBUS network in the automation unit even though the names and ID numbers of the measuring devices differ. Once replaced, the device is either identified automatically (factory setting) or device identification can be set manually.

#### Automatic identification (factory setting)

The Prowirl 200 PROFIBUS PA automatically identifies the measuring device configured in the automation system (Prowirl 72 PROFIBUS PA or Prowirl 73 PROFIBUS PA) and makes the same input and output data and measured value status information available for cyclic data exchange.

Automatic identification is set in the **Ident number selector** parameter using the **Auto** option (factory setting).



### Manual setting

The manual setting is made in the **Ident number selector** parameter using the Prowirl 72 (0x153B) or Prowirl 73 (0x153C) option.

Afterwards, the Prowirl 200 PROFIBUS PA makes the same input and output data and measured status information available for cyclic data exchange.

-  If the Prowirl 200 PROFIBUS PA is acyclically configured via an operating program (Class 2 master), access is directly via the block structure or the parameters of the measuring device.
- If parameters have been changed in the device to be replaced (Prowirl 72 PROFIBUS PA or Prowirl 73 PROFIBUS PA) (parameter setting no longer corresponds to the original factory setting), these parameters must be changed accordingly in the new replacement Prowirl 200 PROFIBUS PA via an operating program (Class 2 master).

*Example*

The setting for low flow cut off has been changed from mass flow (factory setting) to corrected volume flow in a Prowirl 72 PROFIBUS PA currently in operation. This device is now replaced by a Prowirl 200 PROFIBUS PA device. After replacing the device, the assignment for the low flow cut off must be changed manually in the Prowirl 200 PROFIBUS, i.e. to corrected volume flow, to ensure the measuring device behaves identically.

### Replacing the measuring devices without changing the GSD file or restarting the controller

In the procedure described below, the device can be replaced without interrupting ongoing operation or restarting the controller. However with this procedure the measuring device is not fully integrated!

1. Replace the measuring device Prowirl 72 or 73 PROFIBUS PA by a Prowirl 200 PROFIBUS PA device.
2. Set the device address: The same device address that was set for the Prowirl 72, Prowirl 73 or PROFIBUS PA Profile GSD must be used.
3. Connect the Prowirl 200 PROFIBUS PA.

If the factory setting had been changed on the replaced device (Prowirl 72 or Prowirl 73), the following settings may need to be changed:



1. Configuration of the application-specific parameters.
2. Choice of process variables to be transmitted via the CHANNEL parameter in the Analog Input or Totalizer function block.
3. Setting of the units for the process variables.

## 9.3 Cyclic data transmission

Cyclic data transmission when using the device master file (GSD).

### 9.3.1 Block model

The block model shows which input and output data the measuring device makes available for cyclic data exchange. Cyclic data exchange takes place with a PROFIBUS master (Class 1), e.g. a control system etc.

Measuring device				Control system
<b>Transducer Block</b>	Analog Input block 1 to 4	→  66	Output value AI	→
	Totalizer block 1 to 3	→  67	Output value TOTAL	→
			Controller SETTOT	←
				<b>PROFIBUS PA</b>

		Configuration MODETOT	←
Analog Output block 1	→	69	Input values AO ←
Discrete Input block 1 to 2	→	70	Output values DI →
Discrete Output block 1 to 3	→	70	Input values DO ←

### Defined order of modules

The measuring device works as a modular PROFIBUS slave. In contrast to a compact slave, a modular slave has a variable design and consists of several individual modules. The device master file (GSD) contains a description of the individual modules (input and output data) along with their individual properties.

The modules are permanently assigned to the slots, i.e. when configuring the modules, the order and the arrangement of the modules must be respected.

Slot	Module	Function block
1...4	AI	Analog Input block 1 to 4
5	TOTAL or SETTOT_TOTAL or SETTOT_MODETOT_TOTAL	Totalizer block 1
6		Totalizer block 2
7		Totalizer block 3
8	AO	Analog Output block 1
9...10	DI	Discrete Input block 1 to 2
11...13	DO	Discrete Output block 1 to 3

To optimize the data throughput rate of the PROFIBUS network, it is advisable to only configure modules that are processed in the PROFIBUS master system. If this results in gaps between the configured modules, these gaps must be assigned to the EMPTY\_MODULE.

### 9.3.2 Description of the modules

- i** The data structure is described from the perspective of the PROFIBUS master:
- Input data: Are sent from the measuring device to the PROFIBUS master.
  - Output data: Are sent from the PROFIBUS master to the measuring device.

#### AI module (Analog Input)

Transmit an input variable from the measuring device to the PROFIBUS master (Class 1).

The selected input variable, along with the status, is cyclically transmitted to the PROFIBUS Master (Class 1) via the AI module. The input variable is depicted in the first four bytes in the form of a floating point number as per the IEEE 754 standard. The fifth byte contains standardized status information pertaining to the input variable.

Four Analog Input blocks are available (slot 1 to 4).

*Selection: input variable*

The input variable can be specified using the CHANNEL parameter.

CHANNEL	Input variable
33122	Volume flow
32961	Mass flow
33093	Corrected volume flow

CHANNEL	Input variable
708	Flow velocity
33101	Temperature
709	Calculated saturated steam pressure
710	Steam quality
466	Total mass flow
69	Energy flow
465	Heat flow difference
711	Reynolds number
32850	Density
1159	Pressure
2006	Specific volume
1305	Degree of overheating

### Factory setting

Function block	Factory setting
AI 1	Volume flow
AI 2	Mass flow
AI 3	Corrected volume flow
AI 4	Density

### Data structure

#### Input data of Analog Input

Byte 1	Byte 2	Byte 3	Byte 4	Byte 5
Measured value: floating point number (IEEE 754)				Status

### TOTAL module

Transmit a totalizer value from the measuring device to the PROFIBUS master (Class 1).

A selected totalizer value, along with the status, is cyclically transmitted to a PROFIBUS Master (Class 1) via the TOTAL module. The totalizer value is depicted in the first four bytes in the form of a floating point number as per the IEEE 754 standard. The fifth byte contains standardized status information pertaining to the totalizer value.

Three Totalizer blocks are available (slot 5 to 7).

#### Selection: totalizer value

The totalizer value can be specified using the CHANNEL parameter.

CHANNEL	Input variable
33122	Volume flow
32961	Mass flow
33093	Corrected volume flow
466	Total mass flow
467	Condensate mass flow

CHANNEL	Input variable
69	Energy flow
465	Heat flow difference

*Factory setting*

Function block	Factory setting: TOTAL
Totalizer 1, 2 and 3	Volume flow

*Data structure**Input data of TOTAL*

Byte 1	Byte 2	Byte 3	Byte 4	Byte 5
Measured value: floating point number (IEEE 754)				Status

**SETTOT\_TOTAL module**

The module combination consists of the SETTOT and TOTAL functions:

- SETTOT: Control the totalizers via the PROFIBUS master.
- TOTAL: Transmit totalizer value, along with the status, to the PROFIBUS master.

Three Totalizer blocks are available (slot 5 to 7).

*Selection: control totalizer*

CHANNEL	Value SETTOT	Control totalizer
33310	0	Totalize
33046	1	Resetting
33308	2	Adopt totalizer initial setting

*Factory setting*

Function block	Factory setting: Value SETTOT (meaning)
Totalizer 1, 2 and 3	0 (totalizing)

*Data structure**Output data of SETTOT*

Byte 1
Control variable 1

*Input data of TOTAL*

Byte 1	Byte 2	Byte 3	Byte 4	Byte 5
Measured value: floating point number (IEEE 754)				Status

**SETTOT\_MODETOT\_TOTAL module**

The module combination consists of the SETTOT, MODETOT and TOTAL functions:

- SETTOT: Control the totalizers via the PROFIBUS master.
- MODETOT: Configure the totalizers via the PROFIBUS master.
- TOTAL: Transmit totalizer value, along with the status, to the PROFIBUS master.

Three Totalizer blocks are available (slot 5 to 7).

*Selection: totalizer configuration*

CHANNEL	MODETOT value	Totalizer configuration
33306	0	Balancing
33028	1	Balance the positive flow
32976	2	Balance the negative flow
32928	3	Stop totalizing

*Factory setting*

Function block	Factory setting: Value MODETOT (meaning)
Totalizer 1, 2 and 3	0 (balancing)

*Data structure*

*Output data of SETTOT and MODETOT*

Byte 1	Byte 2
Control variable 1: SETTOT	Control variable 2: MODETOT

*Input data of TOTAL*

Byte 1	Byte 2	Byte 3	Byte 4	Byte 5
Measured value: floating point number (IEEE 754)				Status

**AO module (Analog Output)**

Transmit a compensation value from the PROFIBUS master (Class 1) to the measuring device.

A compensation value, along with the status, is cyclically transmitted from the PROFIBUS Master (Class 1) to the measuring device via the AO module. The compensation value is depicted in the first four bytes in the form of a floating point number as per the IEEE 754 standard. The fifth byte contains standardized status information pertaining to the compensation value.

One Analog Output block is available (slot 8).

*Assigned compensation values*

A compensation value is permanently assigned to the individual Analog Output blocks.

CHANNEL	Function block	Compensation value
1507	AO 1	External compensation

 The selection is made via: "Expert" menu → Sensor → External compensation

*Data structure**Output data of Analog Output*

Byte 1	Byte 2	Byte 3	Byte 4	Byte 5
Measured value: floating point number (IEEE 754)				Status

**DI module (Discrete Input)**

Transmit discrete input values from the measuring device to the PROFIBUS master (Class 1). Discrete input values are used by the measuring device to transmit the state of device functions to the PROFIBUS master (Class 1).

The DI module cyclically transmits the discrete input value, along with the status, to the PROFIBUS Master (Class 1). The discrete input value is depicted in the first byte. The second byte contains standardized status information pertaining to the input value.

Two Discrete Input blocks are available (slot 9 to 10).

*Selection: device function*

The device function can be specified using the CHANNEL parameter.

CHANNEL	Device function	Factory setting: Status (meaning)
893	Switch output state	<ul style="list-style-type: none"> <li>▪ 0 (device function not active)</li> <li>▪ 1 (device function active)</li> </ul>
895	Low flow cut off	
1430	Status verification <sup>1)</sup>	

1) Only available with the "Heartbeat Verification" application package

*Factory setting*

Function block	Factory setting
DI 1	Switch output state
DI 2	Low flow cut off

*Data structure**Input data of Discrete Input*

Byte 1	Byte 2
Discrete	Status

**DO module (Discrete Output)**

Transmit discrete output values from the PROFIBUS master (Class 1) to the measuring device. Discrete output values are used by the PROFIBUS master (Class 1) to enable and disable device functions.

The DO module cyclically transmits the discrete output value, along with the status, to the measuring device. The discrete output value is depicted in the first byte. The second byte contains standardized status information pertaining to the output value.

Three Discrete Output blocks are available (slot 11 to 13).

*Assigned device functions*

A device function is permanently assigned to the individual Discrete Output blocks.

CHANNEL	Function block	Device function	Values: control (meaning)
891	DO 1	Flow override	<ul style="list-style-type: none"> <li>■ 0 (disable device function)</li> <li>■ 1 (enable device function)</li> </ul>
1429	DO 2	Start verification <sup>1)</sup>	

1) Only available with the Heartbeat Verification application package

*Data structure**Output data of Discrete Output*

Byte 1	Byte 2
Discrete	Status



**EMPTY\_MODULE module**

This module is used to assign empty spaces arising from modules not being used in the slots →  66.

## 10 Commissioning



### 10.1 Function check

Before commissioning the measuring device:

- ▶ Make sure that the post-installation and post-connection checks have been performed.
  - "Post-installation check" checklist →  27
  - "Post-connection check" checklist →  44

### 10.2 Switching on the measuring device

- ▶ After a successful function check, switch on the measuring device.
  - ↳ After a successful startup, the local display switches automatically from the startup display to the operational display.

 If nothing appears on the local display or a diagnostic message is displayed, refer to the section on "Diagnostics and troubleshooting" →  135.

### 10.3 Configuring the device address via software

In the "**Communication**" submenu the device address can be set.

#### Navigation

"Setup" menu → Communication → Device address

#### 10.3.1 PROFIBUS network

At time of delivery, the measuring device has the following factory setting:

Device address	126
----------------	-----

 If hardware addressing is active, software addressing is blocked

### 10.4 Setting the operating language

Factory setting: English or ordered local language



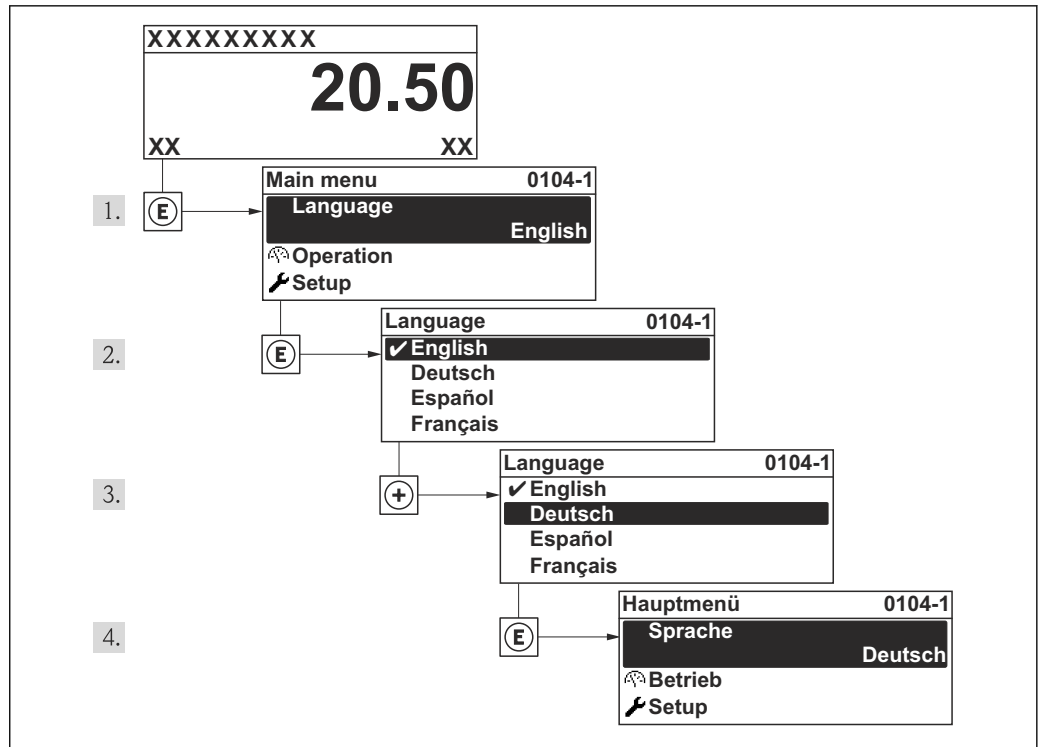

A0013996

19 Taking the example of the local display

## 10.5 Configuring the measuring device

- The **Setup** menu with its guided wizards contains all the parameters needed for standard operation.
- Navigation to the **Setup** menu

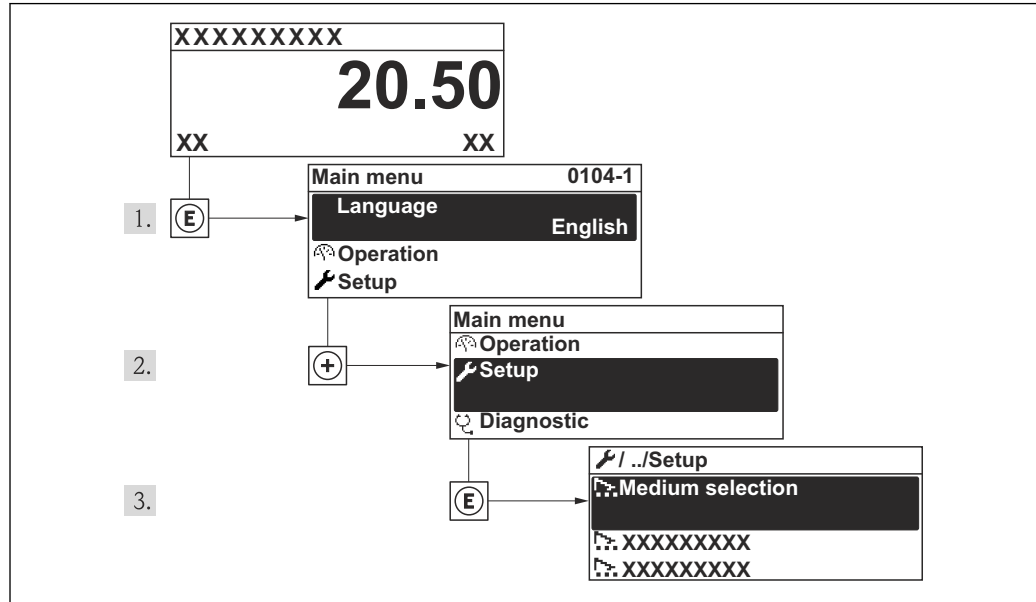

A0014007-EN

20 Taking the example of the local display

### Overview of the wizards in the "Setup" menu

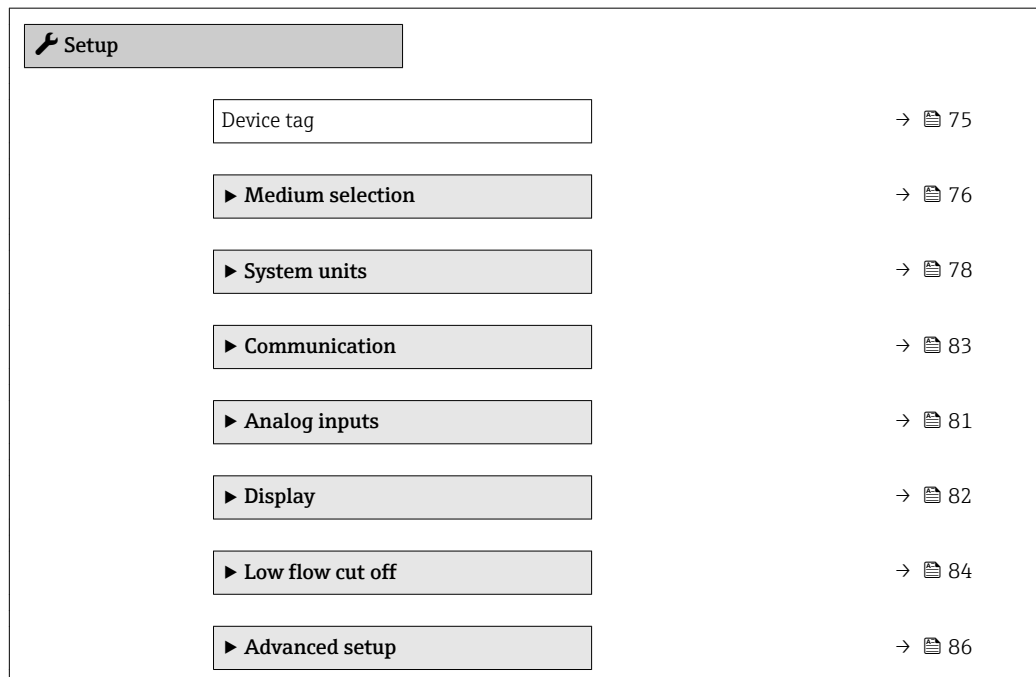

#### 10.5.1 Defining the tag name

To enable fast identification of the measuring point within the system, you can enter a unique designation using the **Device tag** parameter and thus change the factory setting.

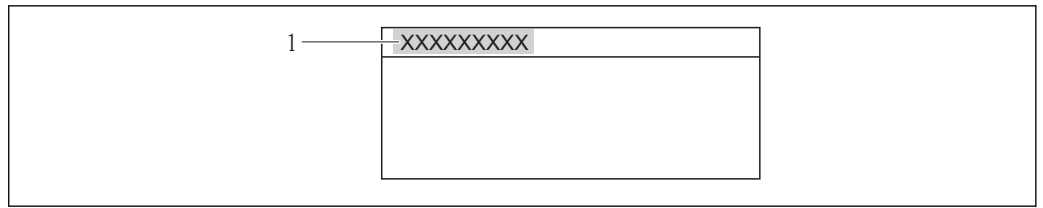

A0013375

21 Header of the operational display with tag name

1 Device tag

-  The number of characters displayed depends on the characters used.
- Enter the tag name in the "FieldCare" operating tool → 62

**Navigation**

"Setup" menu → Device tag

**Parameter overview with brief description**

Parameter	Description	User entry	Factory setting
Device tag	Enter the name for the measuring point.	Max. 32 characters such as letters, numbers or special characters (e.g. @, %, /).	Prowirl 200 PA

### 10.5.2 Selecting and setting the medium

The **Medium selection** wizard guides you systematically through all the parameters that have to be configured for selecting and setting the medium.

#### Navigation

"Setup" menu → Medium selection

#### Structure of the wizard

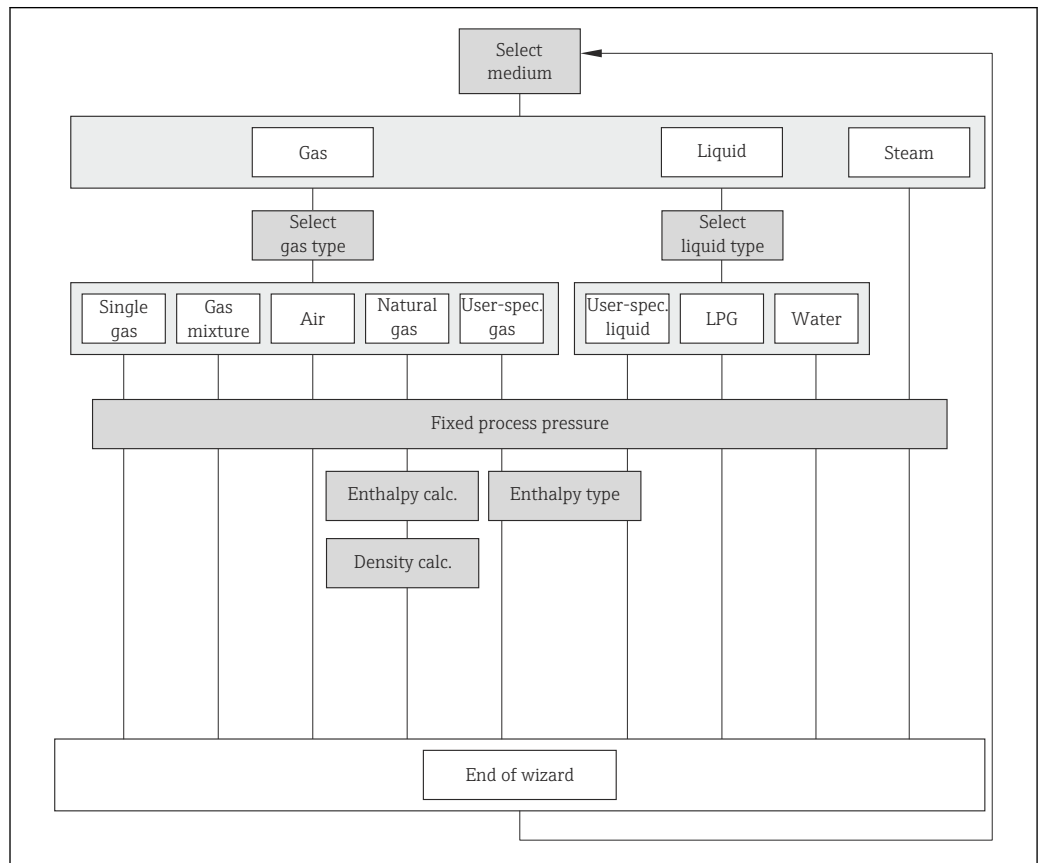



A0020776-EN

22 "Medium selection" wizard in the "Setup" menu

#### Parameter overview with brief description

Parameter	Prerequisite	Description	Selection / User entry	Factory setting
Select medium	-	Select medium type.	<ul style="list-style-type: none"> <li>■ Gas</li> <li>■ Liquid</li> <li>■ Steam</li> </ul>	Steam
Select gas type	The following conditions are met: <ul style="list-style-type: none"> <li>■ Order code                             <ul style="list-style-type: none"> <li>- "Sensor version", option "Mass flow"</li> <li>- "Application package", option "Air + Industrial gases" or option "Natural gas"</li> </ul> </li> <li>■ The <b>Gas</b> option is selected in the <b>Select medium</b> parameter.</li> </ul>	Select measured gas type.	<ul style="list-style-type: none"> <li>■ Single gas</li> <li>■ Gas mixture</li> <li>■ Air</li> <li>■ Natural gas</li> <li>■ User-specific gas</li> </ul>	User-specific gas

Parameter	Prerequisite	Description	Selection / User entry	Factory setting
Select liquid type	The following conditions are met: <ul style="list-style-type: none"> <li>Order code for "Sensor version", option "Mass flow"</li> <li>The <b>Liquid</b> option is selected in the <b>Select medium</b> parameter.</li> </ul>	Select measured liquid type.	<ul style="list-style-type: none"> <li>Water</li> <li>LPG (liquefied petroleum gas)</li> <li>User-specific liquid</li> </ul>	Water
Fixed process pressure	The following conditions are met: <ul style="list-style-type: none"> <li>Order code for "Sensor version", option "Mass flow (integrated temperature measurement)"</li> <li>In the <b>External value</b> parameter (→ 102), the <b>Pressure</b> option is not selected.</li> </ul>	Enter fixed value for process pressure. <i>Dependency</i> The unit is taken from the <b>Pressure unit</b> parameter  For detailed information on the calculation of the measured variables with steam: → 187  For detailed information on setting the parameter in steam applications, see the Special Documentation for the <b>Wet Steam Detection and Wet Steam Measurement</b> → 208 application package.	0 to 250 bar abs.	0 bar abs.
Enthalpy calculation	The following conditions are met: <ul style="list-style-type: none"> <li>Order code <ul style="list-style-type: none"> <li>"Sensor version", option "Mass flow (integrated temperature measurement)"</li> <li>"Application package", option "Natural gas"</li> </ul> </li> <li>In the <b>Select medium</b> parameter, the <b>Gas</b> option is selected and in the <b>Select gas type</b> parameter, the <b>Natural gas</b> option is selected.</li> </ul>	Select the norm the enthalpy calculation is based on.	<ul style="list-style-type: none"> <li>AGA5</li> <li>ISO 6976</li> </ul>	AGA5
Density calculation	The following conditions are met: <ul style="list-style-type: none"> <li>In the <b>Select medium</b> parameter, the <b>Gas</b> option is selected.</li> <li>In the <b>Select gas type</b> parameter, the <b>Natural gas</b> option is selected.</li> </ul>	Select the norm the density calculation is based on.	<ul style="list-style-type: none"> <li>AGA Nx19</li> <li>ISO 12213- 2</li> <li>ISO 12213- 3</li> </ul>	AGA Nx19
Enthalpy type	The following conditions are met: <ul style="list-style-type: none"> <li>In the <b>Select gas type</b> parameter, the <b>User-specific gas</b> option is selected.</li> <li>Or</li> <li>In the <b>Select liquid type</b> parameter, the <b>User-specific liquid</b> option is selected.</li> </ul>	Define which kind of enthalpy is used.	<ul style="list-style-type: none"> <li>Heat</li> <li>Calorific value</li> </ul>	Heat

### 10.5.3 Setting the system units

In the **System units** submenu the units of all the measured values can be set.

#### Navigation

"Setup" menu → System units

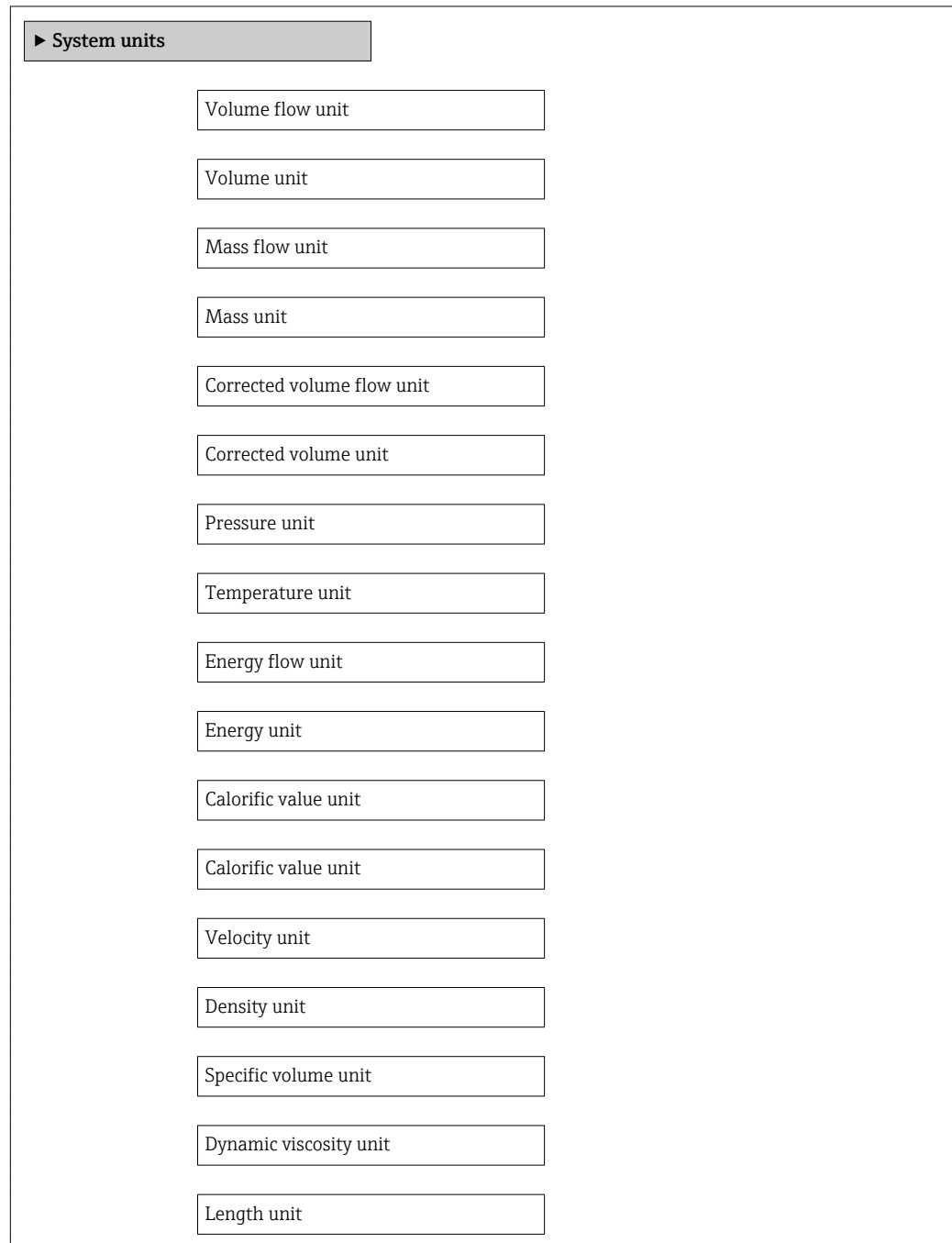

The screenshot displays the 'System units' submenu. At the top, there is a grey header bar with a right-pointing arrow and the text 'System units'. Below this header, there is a vertical list of 17 rectangular input fields, each containing a unit name. The units listed are: Volume flow unit, Volume unit, Mass flow unit, Mass unit, Corrected volume flow unit, Corrected volume unit, Pressure unit, Temperature unit, Energy flow unit, Energy unit, Calorific value unit, Calorific value unit, Velocity unit, Density unit, Specific volume unit, Dynamic viscosity unit, and Length unit.

Unit Name
Volume flow unit
Volume unit
Mass flow unit
Mass unit
Corrected volume flow unit
Corrected volume unit
Pressure unit
Temperature unit
Energy flow unit
Energy unit
Calorific value unit
Calorific value unit
Velocity unit
Density unit
Specific volume unit
Dynamic viscosity unit
Length unit

## Parameter overview with brief description

Parameter	Prerequisite	Description	Selection	Factory setting
Volume flow unit	–	Select volume flow unit. <i>Effect</i> The selected unit applies for: <ul style="list-style-type: none"> <li>▪ Output</li> <li>▪ Low flow cut off</li> <li>▪ Simulation process variable</li> </ul>	Unit choose list	Country-specific: <ul style="list-style-type: none"> <li>▪ m<sup>3</sup>/h</li> <li>▪ ft<sup>3</sup>/min</li> </ul>
Volume unit	–	Select volume unit.	Unit choose list	Country-specific: <ul style="list-style-type: none"> <li>▪ m<sup>3</sup></li> <li>▪ ft<sup>3</sup></li> </ul>
Mass flow unit	–	Select mass flow unit. <i>Effect</i> The selected unit applies for: <ul style="list-style-type: none"> <li>▪ Output</li> <li>▪ Low flow cut off</li> <li>▪ Simulation process variable</li> </ul>	Unit choose list	Country-specific: <ul style="list-style-type: none"> <li>▪ kg/h</li> <li>▪ lb/min</li> </ul>
Mass unit	–	Select mass unit.	Unit choose list	Country-specific: <ul style="list-style-type: none"> <li>▪ kg</li> <li>▪ lb</li> </ul>
Corrected volume flow unit	–	Select corrected volume flow unit. <i>Effect</i> The selected unit applies for: Corrected volume flow	Unit choose list	Country-specific: <ul style="list-style-type: none"> <li>▪ Nm<sup>3</sup>/h</li> <li>▪ Sft<sup>3</sup>/h</li> </ul>
Corrected volume unit	–	Select corrected volume unit.	Unit choose list	Country-specific: <ul style="list-style-type: none"> <li>▪ Nm<sup>3</sup></li> <li>▪ Sft<sup>3</sup></li> </ul>
Pressure unit	For the following order code: "Sensor version", option "Mass flow"	Select process pressure unit. <i>Effect</i> The unit is taken from the: <ul style="list-style-type: none"> <li>▪ Calculated saturated steam pressure</li> <li>▪ Atmospheric pressure</li> <li>▪ Maximum value</li> <li>▪ Fixed process pressure</li> <li>▪ Pressure</li> <li>▪ Reference pressure</li> </ul>	Unit choose list	Country-specific: <ul style="list-style-type: none"> <li>▪ bar</li> <li>▪ psi</li> </ul>
Temperature unit	–	Select temperature unit. <i>Effect</i> The selected unit applies for: <ul style="list-style-type: none"> <li>▪ Temperature</li> <li>▪ Maximum value</li> <li>▪ Minimum value</li> <li>▪ Average value</li> <li>▪ Maximum value</li> <li>▪ Minimum value</li> <li>▪ Maximum value</li> <li>▪ Minimum value</li> <li>▪ 2nd temperature delta heat</li> <li>▪ Fixed temperature</li> <li>▪ Reference combustion temperature</li> <li>▪ Reference temperature</li> <li>▪ Saturation temperature</li> </ul>	Unit choose list	Country-specific: <ul style="list-style-type: none"> <li>▪ °C</li> <li>▪ °F</li> </ul>

Parameter	Prerequisite	Description	Selection	Factory setting
Energy flow unit	For the following order code: "Sensor version", option "Mass flow"	Select energy flow unit. <i>Result</i> The selected unit applies for: <ul style="list-style-type: none"> <li>▪ Outputs</li> <li>▪ Low flow cut off</li> </ul>	Unit choose list	Country-specific: <ul style="list-style-type: none"> <li>▪ kW</li> <li>▪ Btu/h</li> </ul>
Energy unit	For the following order code: "Sensor version", option "Mass flow"	Select energy unit.	Unit choose list	Country-specific: <ul style="list-style-type: none"> <li>▪ kWh</li> <li>▪ Btu</li> </ul>
Calorific value unit	The following conditions are met: <ul style="list-style-type: none"> <li>▪ Order code for "Sensor version", option "Mass flow"</li> <li>▪ The <b>Gross calorific value volume</b> option or the <b>Net calorific value volume</b> option is selected in the <b>Calorific value type</b> parameter.</li> </ul>	Select calorific value unit. <i>Result</i> The selected unit applies for: Reference gross calorific value	Unit choose list	Country-specific: <ul style="list-style-type: none"> <li>▪ kJ/Nm<sup>3</sup></li> <li>▪ Btu/Sft<sup>3</sup></li> </ul>
Calorific value unit (Mass)	The following conditions are met: <ul style="list-style-type: none"> <li>▪ Order code for "Sensor version", option "Mass flow"</li> <li>▪ The <b>Gross calorific value mass</b> option or the <b>Net calorific value mass</b> option is selected in the <b>Calorific value type</b> parameter.</li> </ul>	Select calorific value unit.	Unit choose list	Country-specific: <ul style="list-style-type: none"> <li>▪ kJ/kg</li> <li>▪ Btu/lb</li> </ul>
Velocity unit	–	Select velocity unit. <i>Result</i> The selected unit applies for: <ul style="list-style-type: none"> <li>▪ Flow velocity</li> <li>▪ Maximum value</li> </ul>	Unit choose list	Country-specific: <ul style="list-style-type: none"> <li>▪ m/s</li> <li>▪ ft/s</li> </ul>
Density unit	–	Select density unit. <i>Effect</i> The selected unit applies for: <ul style="list-style-type: none"> <li>▪ Output</li> <li>▪ Simulation process variable</li> </ul>	Unit choose list	Country-specific: <ul style="list-style-type: none"> <li>▪ kg/m<sup>3</sup></li> <li>▪ lb/ft<sup>3</sup></li> </ul>
Specific volume unit	For the following order code: "Sensor version", option "Mass flow"	Select the unit for the specific volume. <i>Result</i> The selected unit applies for: Specific volume	Unit choose list	Country-specific: <ul style="list-style-type: none"> <li>▪ m<sup>3</sup>/kg</li> <li>▪ ft<sup>3</sup>/lb</li> </ul>
Dynamic viscosity unit	–	Select dynamic viscosity unit. <i>Result</i> The selected unit applies for: <ul style="list-style-type: none"> <li>▪ <b>Dynamic viscosity</b> parameter (gases)</li> <li>▪ <b>Dynamic viscosity</b> parameter (liquids)</li> </ul>	Unit choose list	Pa s
Length unit	–	Select length unit for nominal diameter. <i>Effect</i> The selected unit applies for: <ul style="list-style-type: none"> <li>▪ Inlet run</li> <li>▪ Mating pipe diameter</li> </ul>	Unit choose list	Country-specific: <ul style="list-style-type: none"> <li>▪ mm</li> <li>▪ in</li> </ul>



### 10.5.4 Configuring the analog inputs

The **Analog inputs** submenu guides you systematically to the individual **Analog input 1 to 4** submenu. From here you get to the parameters of the individual analog input.

#### Navigation

"Setup" menu → Analog inputs

The screenshot shows a hierarchical menu structure. At the top is a grey box labeled '► Analog inputs'. Below it is another grey box labeled '► Analog input 1 to 4'. Underneath this are four white rectangular input fields, each containing a parameter name: 'Channel', 'PV filter time', 'Fail safe type', and 'Fail safe value'.

#### Parameter overview with brief description

Parameter	Prerequisite	Description	Selection / User entry	Factory setting
Channel	–	Select the process variable.	<ul style="list-style-type: none"> <li>■ Volume flow</li> <li>■ Mass flow</li> <li>■ Corrected volume flow</li> <li>■ Flow velocity</li> <li>■ Temperature</li> <li>■ Calculated saturated steam pressure *</li> <li>■ Steam quality *</li> <li>■ Total mass flow *</li> <li>■ Energy flow *</li> <li>■ Heat flow difference *</li> <li>■ Reynolds number *</li> <li>■ Density *</li> <li>■ Pressure *</li> <li>■ Specific volume *</li> <li>■ Degrees of superheat *</li> </ul>	Volume flow
PV filter time	–	Specify the time to suppress signal peaks. During the specified time the analog input does not respond to an erratic increase in the process variable.	Positive floating-point number	0
Fail safe type	–	Select the failure mode.	<ul style="list-style-type: none"> <li>■ Fail safe value</li> <li>■ Fallback value</li> <li>■ Off</li> </ul>	Off
Fail safe value	In <b>Fail safe type</b> parameter, the <b>Fail safe value</b> option is selected.	Specify the values to be output when an error occurs.	Signed floating-point number	0

\* Visibility depends on order options or device settings

### 10.5.5 Configuring the local display

The **Display** wizard guides you systematically through all the parameters that can be configured for configuring the local display.

#### Navigation

"Setup" menu → Display

#### Structure of the wizard

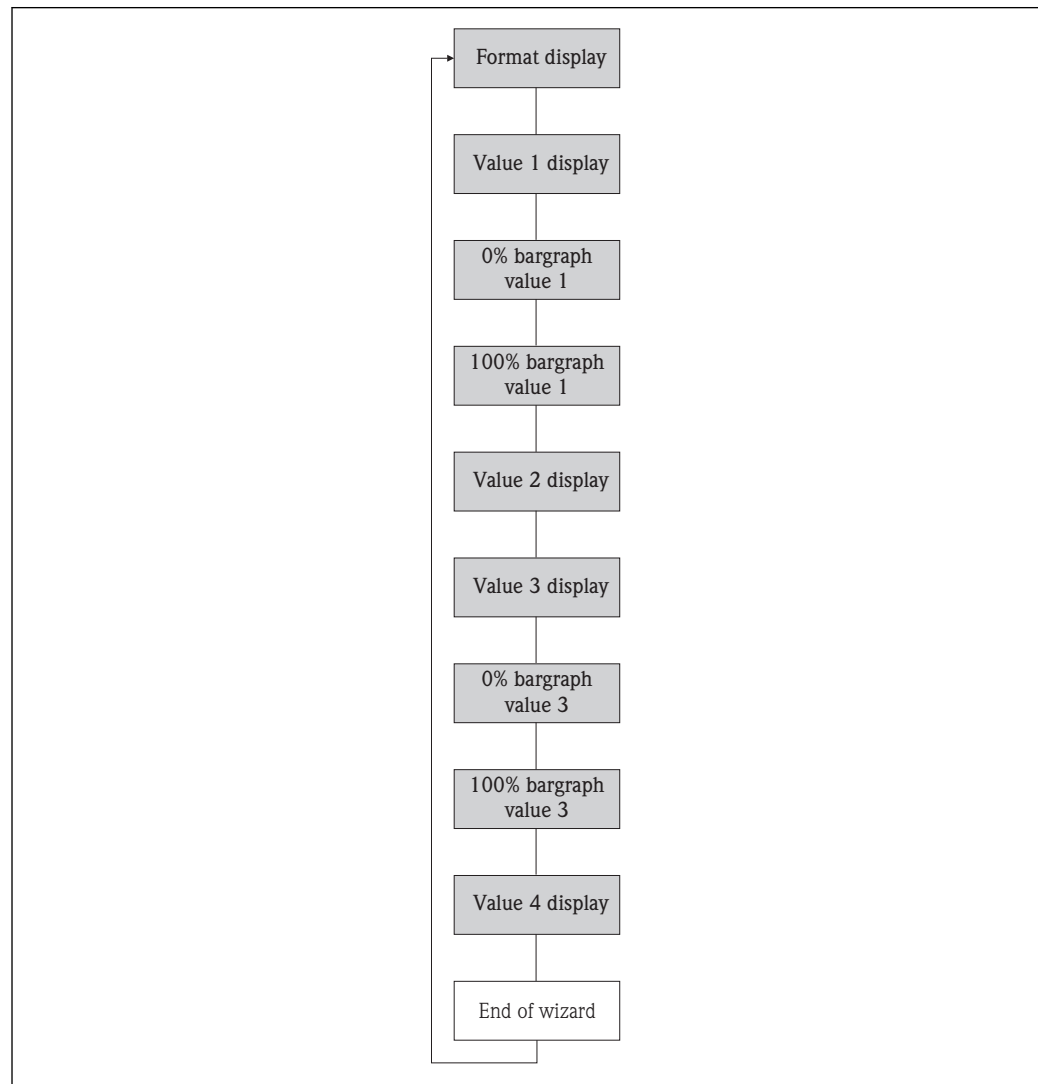

A0013797-EN

23 "Display" wizard in the "Setup" menu

## Parameter overview with brief description

Parameter	Prerequisite	Description	Selection / User entry	Factory setting
Format display	A local display is provided.	Select how measured values are shown on the display.	<ul style="list-style-type: none"> <li>■ 1 value, max. size</li> <li>■ 1 bargraph + 1 value</li> <li>■ 2 values</li> <li>■ 1 value large + 2 values</li> <li>■ 4 values</li> </ul>	1 value, max. size
Value 1 display	A local display is provided.	Select the measured value that is shown on the local display.	<ul style="list-style-type: none"> <li>■ Volume flow</li> <li>■ Corrected volume flow</li> <li>■ Mass flow</li> <li>■ Flow velocity</li> <li>■ Temperature</li> <li>■ Calculated saturated steam pressure *</li> <li>■ Steam quality *</li> <li>■ Total mass flow *</li> <li>■ Condensate mass flow *</li> <li>■ Energy flow *</li> <li>■ Heat flow difference *</li> <li>■ Reynolds number *</li> <li>■ Density *</li> <li>■ Pressure *</li> <li>■ Specific volume *</li> <li>■ Degrees of superheat *</li> <li>■ Totalizer 1</li> <li>■ Totalizer 2</li> <li>■ Totalizer 3</li> </ul>	Volume flow
0% bargraph value 1	A local display is provided.	Enter 0% value for bar graph display.	Signed floating-point number	Country-specific: <ul style="list-style-type: none"> <li>■ 0 m<sup>3</sup>/h</li> <li>■ 0 ft<sup>3</sup>/h</li> </ul>
100% bargraph value 1	A local display is provided.	Enter 100% value for bar graph display.	Signed floating-point number	Depends on country and nominal diameter
Value 2 display	A local display is provided.	Select the measured value that is shown on the local display.	Picklist, see <b>Value 1 display</b> parameter	None
Value 3 display	A local display is provided.	Select the measured value that is shown on the local display.	Picklist, see <b>Value 1 display</b> parameter	None
0% bargraph value 3	A selection has been made in the <b>Value 3 display</b> parameter.	Enter 0% value for bar graph display.	Signed floating-point number	Country-specific: <ul style="list-style-type: none"> <li>■ 0 m<sup>3</sup>/h</li> <li>■ 0 ft<sup>3</sup>/h</li> </ul>
100% bargraph value 3	An option has been selected in the <b>Value 3 display</b> parameter.	Enter 100% value for bar graph display.	Signed floating-point number	0
Value 4 display	A local display is provided.	Select the measured value that is shown on the local display.	Picklist, see <b>Value 1 display</b> parameter	None

\* Visibility depends on order options or device settings

### 10.5.6 Configuring communication interface

The **Communication** submenu guides you systematically through all the parameters that have to be configured for selecting and setting the communication interface.

**Navigation**

"Setup" menu → Communication

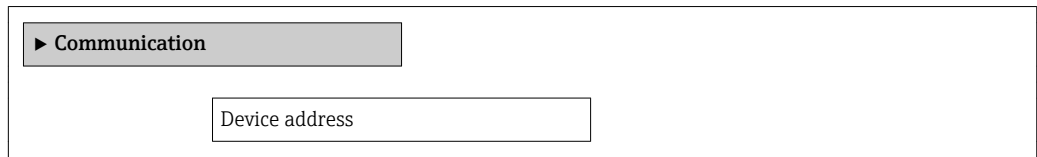

**Parameter overview with brief description**

Parameter	Description	User entry	Factory setting
Device address	Enter device address.	0 to 126	126

**10.5.7 Configuring the low flow cut off**

The **Low flow cut off** wizard guides you systematically through all the parameters that have to be set for configuring the low flow cut off.

**Navigation**

"Setup" menu → Low flow cut off

**Structure of the wizard**

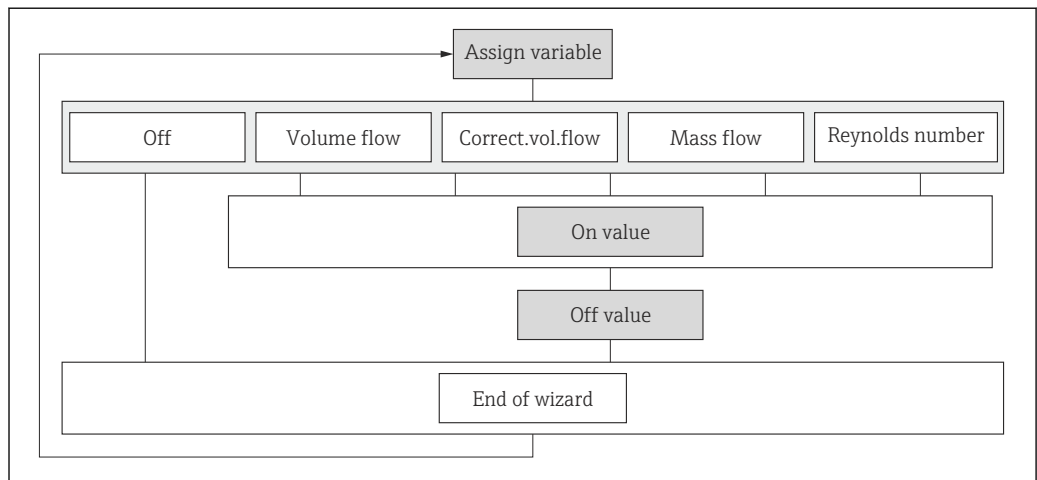

A0020775-EN

24 "Low flow cut off" wizard in the "Setup" menu

## Parameter overview with brief description

Parameter	Prerequisite	Description	Selection / User entry	Factory setting
Assign process variable	–	Select process variable for low flow cut off.	<ul style="list-style-type: none"> <li>■ Off</li> <li>■ Volume flow</li> <li>■ Corrected volume flow</li> <li>■ Mass flow</li> <li>■ Reynolds number *</li> </ul>	Off
On value low flow cutoff	One of the following options is selected in the <b>Assign process variable</b> parameter (→ 85): <ul style="list-style-type: none"> <li>■ Volume flow</li> <li>■ Corrected volume flow</li> <li>■ Mass flow</li> <li>■ Reynolds number *</li> </ul>	Enter on value for low flow cut off.	Positive floating-point number	0
Off value low flow cutoff	One of the following options is selected in the <b>Assign process variable</b> parameter (→ 85): <ul style="list-style-type: none"> <li>■ Volume flow</li> <li>■ Corrected volume flow</li> <li>■ Mass flow</li> <li>■ Reynolds number *</li> </ul>	Enter off value for low flow cut off.	0 to 100.0 %	50 %

\* Visibility depends on order options or device settings

## 10.6 Advanced settings

The **Advanced setup** submenu together with its submenus contains parameters for specific settings.

*Navigation to the "Advanced setup" submenu*

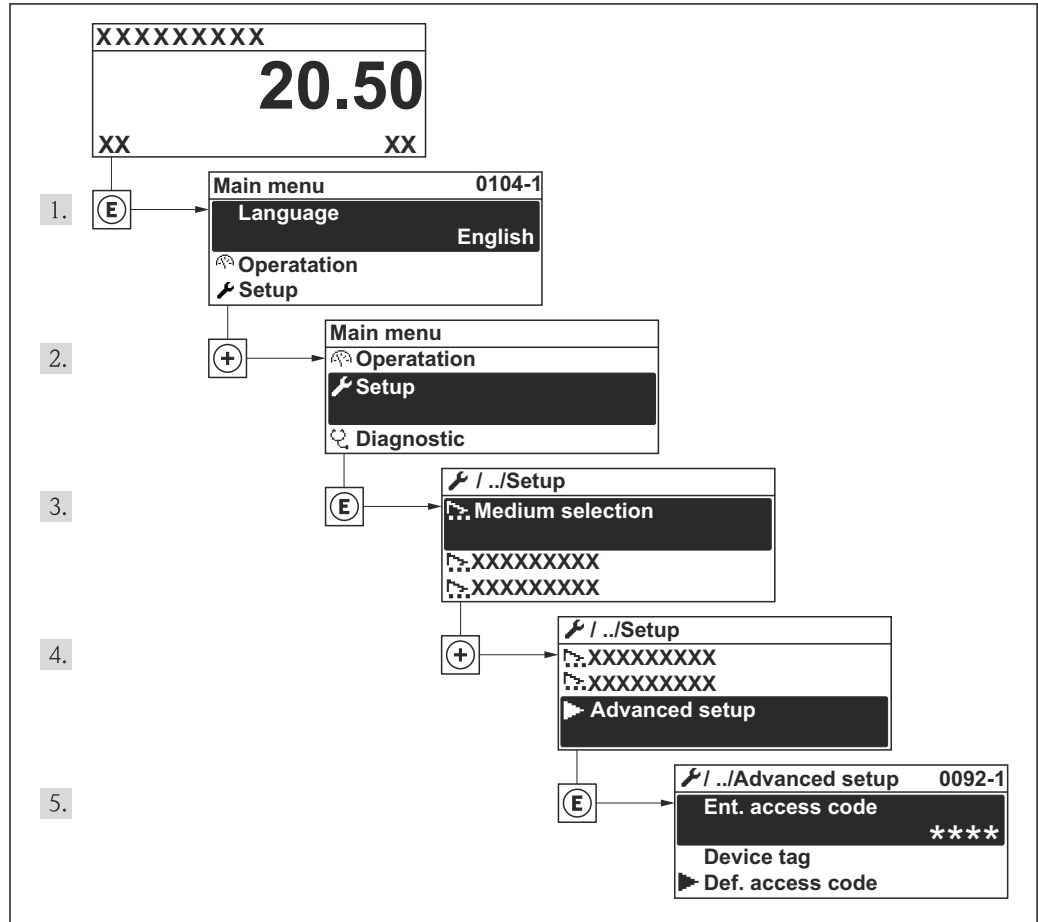

A0014009-EN

25 Taking the example of the local display

**i** The number of submenus can vary depending on the device version. Some submenus are not dealt with in the Operating Instructions. These submenus and the parameters they contain are explained in the Special Documentation for the device.

### Navigation

"Setup" menu → Advanced setup

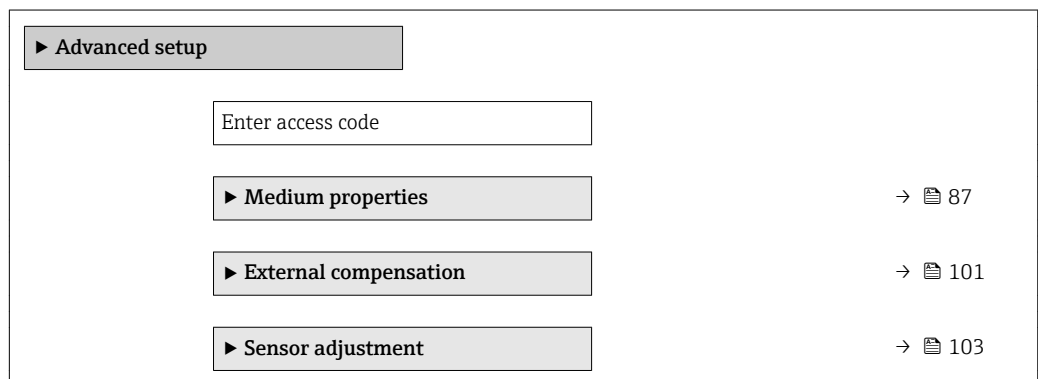

▶ Pulse/frequency/switch output	→ 108
▶ Totalizer 1 to 3	→ 116
▶ Display	→ 118
▶ Heartbeat setup	
▶ Configuration backup display	→ 120
▶ Administration	→ 173

### 10.6.1 Setting the medium properties

In the **Medium properties** submenu the reference values for the measuring application can be set.

#### Navigation

"Setup" menu → Advanced setup → Medium properties

▶ Medium properties

Enthalpy type

Calorific value type

Reference combustion temperature

Reference density

Reference gross calorific value

Reference pressure

Reference temperature

Reference Z-factor

Linear expansion coefficient

Relative density

Specific heat capacity

Calorific value

Z-factor

Dynamic viscosity

Dynamic viscosity
▶ Gas composition

### Parameter overview with brief description

Parameter	Prerequisite	Description	Selection / User entry	Factory setting
Enthalpy type	The following conditions are met: <ul style="list-style-type: none"> <li>▪ In the <b>Select gas type</b> parameter, the <b>User-specific gas</b> option is selected.</li> <li>Or</li> <li>▪ In the <b>Select liquid type</b> parameter, the <b>User-specific liquid</b> option is selected.</li> </ul>	Define which kind of enthalpy is used.	<ul style="list-style-type: none"> <li>▪ Heat</li> <li>▪ Calorific value</li> </ul>	Heat
Calorific value type	The <b>Calorific value type</b> parameter is visible.	Select calculation based on gross calorific value or net calorific value.	<ul style="list-style-type: none"> <li>▪ Gross calorific value volume</li> <li>▪ Net calorific value volume</li> <li>▪ Gross calorific value mass</li> <li>▪ Net calorific value mass</li> </ul>	Gross calorific value mass
Reference combustion temperature	The <b>Reference combustion temperature</b> parameter is visible.	Enter reference combustion temperature to calculate the natural gas energy value.  <i>Dependency</i> The unit is taken from the <b>Temperature unit</b> parameter	-200 to 450 °C	20 °C
Reference density	The following conditions are met: <ul style="list-style-type: none"> <li>▪ In the <b>Select gas type</b> parameter, the <b>User-specific gas</b> option is selected.</li> <li>Or</li> <li>▪ In the <b>Select liquid type</b> parameter, the <b>Water</b> option or <b>User-specific liquid</b> option is selected.</li> </ul>	Enter fixed value for reference density.  <i>Dependency</i> The unit is taken from the <b>Density unit</b> parameter	0.01 to 15 000 kg/m <sup>3</sup>	1 000 kg/m <sup>3</sup>
Reference gross calorific value	The following conditions are met: <ul style="list-style-type: none"> <li>▪ In the <b>Select medium</b> parameter, the <b>Gas</b> option is selected.</li> <li>▪ In the <b>Select gas type</b> parameter, the <b>Natural gas</b> option is selected.</li> <li>▪ In the <b>Density calculation</b> parameter, the <b>ISO 12213-3</b> option is selected.</li> </ul>	Enter reference gross calorific value of the natural gas.  <i>Dependency</i> The unit is taken from the <b>Calorific value unit</b> parameter	Positive floating-point number	50 000 kJ/Nm <sup>3</sup>



Parameter	Prerequisite	Description	Selection / User entry	Factory setting
Reference pressure	The following conditions are met: <ul style="list-style-type: none"> <li>Order code for "Sensor version", option "Mass flow (integrated temperature measurement)"</li> <li>The <b>Gas</b> option is selected in the <b>Select medium</b> parameter.</li> </ul>	Enter reference pressure for the calculation of the reference density. <i>Dependency</i> The unit is taken from the <b>Pressure unit</b> parameter	0 to 250 bar	1.01325 bar
Reference temperature	The following conditions are met: <ul style="list-style-type: none"> <li>The <b>Gas</b> option is selected in the <b>Select medium</b> parameter.</li> <li>Or</li> <li>The <b>Liquid</b> option is selected in the <b>Select medium</b> parameter.</li> </ul>	Enter reference temperature for calculating the reference density. <i>Dependency</i> The unit is taken from the <b>Temperature unit</b> parameter	-200 to 450 °C	20 °C
Reference Z-factor	In the <b>Select gas type</b> parameter, the <b>User-specific gas</b> option is selected.	Enter real gas constant Z for gas under reference conditions.	0.1 to 2	1
Linear expansion coefficient	The following conditions are met: <ul style="list-style-type: none"> <li>The <b>Liquid</b> option is selected in the <b>Select medium</b> parameter.</li> <li>The <b>User-specific liquid</b> option is selected in the <b>Select liquid type</b> parameter.</li> </ul>	Enter linear, medium-specific expansion coefficient for calculating the reference density.	$1.0^{-6}$ to $2.0^{-3}$	$2.06^{-4}$
Relative density	The following conditions are met: <ul style="list-style-type: none"> <li>In the <b>Select medium</b> parameter, the <b>Gas</b> option is selected.</li> <li>In the <b>Select gas type</b> parameter, the <b>Natural gas</b> option is selected.</li> <li>In the <b>Density calculation</b> parameter, the <b>ISO 12213-3</b> option is selected.</li> </ul>	Enter a relative density of the natural gas.	0.55 to 0.9	0.664
Specific heat capacity	The following conditions are met: <ul style="list-style-type: none"> <li>Selected medium: <ul style="list-style-type: none"> <li>In the <b>Select gas type</b> parameter, the <b>User-specific gas</b> option is selected.</li> <li>Or</li> <li>In the <b>Select liquid type</b> parameter, the <b>User-specific liquid</b> option is selected.</li> </ul> </li> <li>In the <b>Enthalpy type</b> parameter, the <b>Heat</b> option is selected.</li> </ul>	Enter the specific heat capacity of the medium. <i>Dependency</i> The unit is taken from the <b>Specific heat capacity unit</b> parameter	0 to 50 kJ/(kgK)	4.187 kJ/(kgK)

Parameter	Prerequisite	Description	Selection / User entry	Factory setting
Calorific value	The following conditions are met: <ul style="list-style-type: none"> <li>▪ Selected medium: <ul style="list-style-type: none"> <li>– In the <b>Select gas type</b> parameter, the <b>User-specific gas</b> option is selected.</li> <li>Or</li> <li>– In the <b>Select liquid type</b> parameter, the <b>User-specific liquid</b> option is selected.</li> </ul> </li> <li>▪ In the <b>Enthalpy type</b> parameter, the <b>Calorific value</b> option is selected.</li> <li>▪ In the <b>Calorific value type</b> parameter, the <b>Gross calorific value volume</b> option or <b>Gross calorific value mass</b> option is selected.</li> </ul>	Enter gross calorific value to calculate the energy flow.	Positive floating-point number	50 000 kJ/kg
Z-factor	In the <b>Select gas type</b> parameter, the <b>User-specific gas</b> option is selected.	Enter real gas constant Z for gas under operation conditions.	0.1 to 2.0	1
Dynamic viscosity (Gases)	The following conditions are met: <ul style="list-style-type: none"> <li>▪ Order code for "Sensor version", option "Volume flow"</li> <li>▪ The <b>Gas</b> option or the <b>Steam</b> option is selected in the <b>Select medium</b> parameter.</li> <li>Or</li> <li>▪ The <b>User-specific gas</b> option is selected in the <b>Select gas type</b> parameter.</li> </ul>	Enter fixed value for dynamic viscosity for a gas/steam. <i>Dependency</i> The unit is taken from the <b>Dynamic viscosity unit</b> parameter.	Positive floating-point number	0.015 cP
Dynamic viscosity (Liquids)	The following conditions are met: <ul style="list-style-type: none"> <li>▪ Order code for "Sensor version", option "Volume flow"</li> <li>▪ The <b>Liquid</b> option is selected in the <b>Select medium</b> parameter.</li> <li>Or</li> <li>▪ The <b>User-specific liquid</b> option is selected in the <b>Select liquid type</b> parameter.</li> </ul>	Enter fixed value for dynamic viscosity for a liquid. <i>Dependency</i> The unit is taken from the <b>Dynamic viscosity unit</b> parameter.	Positive floating-point number	1 cP

### Configuring the gas composition

In the **Gas composition** submenu the gas composition for the measuring application can be set.

**Navigation**

"Setup" menu → Advanced setup → Medium properties → Gas composition

► Gas composition

Gas type

Gas mixture

Mol% Ar

Mol% C<sub>2</sub>H<sub>3</sub>Cl

Mol% C<sub>2</sub>H<sub>4</sub>

Mol% C<sub>2</sub>H<sub>6</sub>

Mol% C<sub>3</sub>H<sub>8</sub>

Mol% CH<sub>4</sub>

Mol% Cl<sub>2</sub>

Mol% CO

Mol% CO<sub>2</sub>

Mol% H<sub>2</sub>

Mol% H<sub>2</sub>O

Mol% H<sub>2</sub>S

Mol% HCl

Mol% He

Mol% i-C<sub>4</sub>H<sub>10</sub>

Mol% i-C<sub>5</sub>H<sub>12</sub>

Mol% Kr

Mol% N<sub>2</sub>

Mol% n-C<sub>10</sub>H<sub>22</sub>

Mol% n-C<sub>4</sub>H<sub>10</sub>

Mol% n-C <sub>5</sub> H <sub>12</sub>
Mol% n-C <sub>6</sub> H <sub>14</sub>
Mol% n-C <sub>7</sub> H <sub>16</sub>
Mol% n-C <sub>8</sub> H <sub>18</sub>
Mol% n-C <sub>9</sub> H <sub>20</sub>
Mol% Ne
Mol% NH <sub>3</sub>
Mol% O <sub>2</sub>
Mol% SO <sub>2</sub>
Mol% Xe
Mol% other gas
Relative humidity

## Parameter overview with brief description

Parameter	Prerequisite	Description	Selection / User entry	Factory setting
Gas type	<p>The following conditions are met:</p> <ul style="list-style-type: none"> <li>▪ In the <b>Select medium</b> parameter, the <b>Gas</b> option is selected.</li> <li>▪ In the <b>Select gas type</b> parameter, the <b>Single gas</b> option is selected.</li> </ul>	Select measured gas type.	<ul style="list-style-type: none"> <li>▪ Hydrogen H2</li> <li>▪ Helium He</li> <li>▪ Neon Ne</li> <li>▪ Argon Ar</li> <li>▪ Krypton Kr</li> <li>▪ Xenon Xe</li> <li>▪ Nitrogen N2</li> <li>▪ Oxygen O2</li> <li>▪ Chlorine Cl2</li> <li>▪ Ammonia NH3</li> <li>▪ Carbon monoxide CO</li> <li>▪ Carbon dioxide CO2</li> <li>▪ Sulfur dioxide SO2</li> <li>▪ Hydrogen sulfide H2S</li> <li>▪ Hydrogen chloride HCl</li> <li>▪ Methane CH4</li> <li>▪ Ethane C2H6</li> <li>▪ Propane C3H8</li> <li>▪ Butane C4H10</li> <li>▪ Ethylene C2H4</li> <li>▪ Vinyl Chloride C2H3Cl</li> </ul>	Methane CH4
Gas mixture	<p>The following conditions are met:</p> <ul style="list-style-type: none"> <li>▪ In the <b>Select medium</b> parameter, the <b>Gas</b> option is selected.</li> <li>▪ In the <b>Select gas type</b> parameter, the <b>Gas mixture</b> option is selected.</li> </ul>	Select measured gas mixture.	<ul style="list-style-type: none"> <li>▪ Hydrogen H2</li> <li>▪ Helium He</li> <li>▪ Neon Ne</li> <li>▪ Argon Ar</li> <li>▪ Krypton Kr</li> <li>▪ Xenon Xe</li> <li>▪ Nitrogen N2</li> <li>▪ Oxygen O2</li> <li>▪ Chlorine Cl2</li> <li>▪ Ammonia NH3</li> <li>▪ Carbon monoxide CO</li> <li>▪ Carbon dioxide CO2</li> <li>▪ Sulfur dioxide SO2</li> <li>▪ Hydrogen sulfide H2S</li> <li>▪ Hydrogen chloride HCl</li> <li>▪ Methane CH4</li> <li>▪ Ethane C2H6</li> <li>▪ Propane C3H8</li> <li>▪ Butane C4H10</li> <li>▪ Ethylene C2H4</li> <li>▪ Vinyl Chloride C2H3Cl</li> <li>▪ Others</li> </ul>	Methane CH4

Parameter	Prerequisite	Description	Selection / User entry	Factory setting
Mol% Ar	<p>The following conditions are met:</p> <p>In the <b>Select medium</b> parameter, the <b>Gas</b> option is selected.</p> <ul style="list-style-type: none"> <li>- In the <b>Select gas type</b> parameter, the <b>Gas mixture</b> option is selected and in the <b>Gas mixture</b> parameter, the <b>Argon Ar</b> option is selected.</li> </ul> <p>Or</p> <ul style="list-style-type: none"> <li>- In the <b>Select gas type</b> parameter, the <b>Natural gas</b> option is selected and in the <b>Density calculation</b> parameter, the <b>ISO 12213-2</b> option is selected.</li> </ul>	Enter amount of substance for the gas mixture.	0 to 100 %	0 %
Mol% C2H3Cl	<p>The following conditions are met:</p> <ul style="list-style-type: none"> <li>▪ In the <b>Select medium</b> parameter, the <b>Gas</b> option is selected.</li> <li>▪ In the <b>Select gas type</b> parameter, the <b>Gas mixture</b> option is selected.</li> <li>▪ In the <b>Gas mixture</b> parameter, the <b>Vinyl Chloride C2H3Cl</b> option is selected.</li> </ul>	Enter amount of substance for the gas mixture.	0 to 100 %	0 %
Mol% C2H4	<p>The following conditions are met:</p> <ul style="list-style-type: none"> <li>▪ In the <b>Select medium</b> parameter, the <b>Gas</b> option is selected.</li> <li>▪ In the <b>Select gas type</b> parameter, the <b>Gas mixture</b> option is selected.</li> <li>▪ In the <b>Gas mixture</b> parameter, the <b>Ethylene C2H4</b> option is selected.</li> </ul>	Enter amount of substance for the gas mixture.	0 to 100 %	0 %
Mol% C2H6	<p>The following conditions are met:</p> <p>In the <b>Select medium</b> parameter, the <b>Gas</b> option is selected.</p> <ul style="list-style-type: none"> <li>- In the <b>Select gas type</b> parameter, the <b>Gas mixture</b> option is selected and in the <b>Gas mixture</b> parameter, the <b>Ethane C2H6</b> option is selected.</li> </ul> <p>Or</p> <ul style="list-style-type: none"> <li>- In the <b>Select gas type</b> parameter, the <b>Natural gas</b> option is selected and in the <b>Density calculation</b> parameter, the <b>ISO 12213-2</b> option is selected.</li> </ul>	Enter amount of substance for the gas mixture.	0 to 100 %	0 %

Parameter	Prerequisite	Description	Selection / User entry	Factory setting
Mol% C3H8	<p>The following conditions are met:</p> <p>In the <b>Select medium</b> parameter, the <b>Gas</b> option is selected.</p> <ul style="list-style-type: none"> <li>- In the <b>Select gas type</b> parameter, the <b>Gas mixture</b> option is selected and in the <b>Gas mixture</b> parameter, the <b>Propane C3H8</b> option is selected.</li> </ul> <p>Or</p> <ul style="list-style-type: none"> <li>- In the <b>Select gas type</b> parameter, the <b>Natural gas</b> option is selected and in the <b>Density calculation</b> parameter, the <b>ISO 12213-2</b> option is selected.</li> </ul>	Enter amount of substance for the gas mixture.	0 to 100 %	0 %
Mol% CH4	<p>The following conditions are met:</p> <p>In the <b>Select medium</b> parameter, the <b>Gas</b> option is selected.</p> <ul style="list-style-type: none"> <li>- In the <b>Select gas type</b> parameter, the <b>Gas mixture</b> option is selected and in the <b>Gas mixture</b> parameter, the <b>Methane CH4</b> option is selected.</li> </ul> <p>Or</p> <ul style="list-style-type: none"> <li>- In the <b>Select gas type</b> parameter, the <b>Natural gas</b> option is selected.</li> </ul>	Enter amount of substance for the gas mixture.	0 to 100 %	100 %
Mol% Cl2	<p>The following conditions are met:</p> <ul style="list-style-type: none"> <li>▪ In the <b>Select medium</b> parameter, the <b>Gas</b> option is selected.</li> <li>▪ In the <b>Select gas type</b> parameter, the <b>Gas mixture</b> option is selected.</li> <li>▪ In the <b>Gas mixture</b> parameter, the <b>Chlorine Cl2</b> option is selected.</li> </ul>	Enter amount of substance for the gas mixture.	0 to 100 %	0 %
Mol% CO	<p>The following conditions are met:</p> <p>In the <b>Select medium</b> parameter, the <b>Gas</b> option is selected.</p> <ul style="list-style-type: none"> <li>- In the <b>Select gas type</b> parameter, the <b>Gas mixture</b> option is selected and in the <b>Gas mixture</b> parameter, the <b>Carbon monoxide CO</b> option is selected.</li> </ul> <p>Or</p> <ul style="list-style-type: none"> <li>- In the <b>Select gas type</b> parameter, the <b>Natural gas</b> option is selected and in the <b>Density calculation</b> parameter, the <b>ISO 12213-2</b> option is selected.</li> </ul>	Enter amount of substance for the gas mixture.	0 to 100 %	0 %

Parameter	Prerequisite	Description	Selection / User entry	Factory setting
Mol% CO2	The following conditions are met: In the <b>Select medium</b> parameter, the <b>Gas</b> option is selected. - In the <b>Select gas type</b> parameter, the <b>Gas mixture</b> option is selected and in the <b>Gas mixture</b> parameter, the <b>Carbon dioxide CO2</b> option is selected. Or - In the <b>Select gas type</b> parameter, the <b>Natural gas</b> option is selected.	Enter amount of substance for the gas mixture.	0 to 100 %	0 %
Mol% H2	The following conditions are met: In the <b>Select medium</b> parameter, the <b>Gas</b> option is selected. - In the <b>Select gas type</b> parameter, the <b>Gas mixture</b> option is selected and in the <b>Gas mixture</b> parameter, the <b>Hydrogen H2</b> option is selected. Or - In the <b>Select gas type</b> parameter, the <b>Natural gas</b> option is selected and in the <b>Density calculation</b> parameter, the <b>AGA Nx19</b> option is <b>not</b> selected.	Enter amount of substance for the gas mixture.	0 to 100 %	0 %
Mol% H2O	The following conditions are met: ▪ In the <b>Select medium</b> parameter, the <b>Gas</b> option is selected. ▪ In the <b>Select gas type</b> parameter, the <b>Natural gas</b> option is selected. ▪ In the <b>Density calculation</b> parameter, the <b>ISO 12213-2</b> option is selected.	Enter amount of substance for the gas mixture.	0 to 100 %	0 %
Mol% H2S	The following conditions are met: In the <b>Select medium</b> parameter, the <b>Gas</b> option is selected. - In the <b>Select gas type</b> parameter, the <b>Gas mixture</b> option is selected and in the <b>Gas mixture</b> parameter, the <b>Hydrogen sulfide H2S</b> option is selected. Or - In the <b>Select gas type</b> parameter, the <b>Natural gas</b> option is selected and in the <b>Density calculation</b> parameter, the <b>ISO 12213-2</b> option is selected.	Enter amount of substance for the gas mixture.	0 to 100 %	0 %



Parameter	Prerequisite	Description	Selection / User entry	Factory setting
Mol% HCl	The following conditions are met: <ul style="list-style-type: none"> <li>▪ In the <b>Select medium</b> parameter, the <b>Gas</b> option is selected.</li> <li>▪ In the <b>Select gas type</b> parameter, the <b>Gas mixture</b> option is selected.</li> <li>▪ In the <b>Gas mixture</b> parameter, the <b>Hydrogen chloride HCl</b> option is selected.</li> </ul>	Enter amount of substance for the gas mixture.	0 to 100 %	0 %
Mol% He	The following conditions are met: In the <b>Select medium</b> parameter, the <b>Gas</b> option is selected. – In the <b>Select gas type</b> parameter, the <b>Gas mixture</b> option is selected and in the <b>Gas mixture</b> parameter, the <b>Helium He</b> option is selected. Or – In the <b>Select gas type</b> parameter, the <b>Natural gas</b> option is selected and in the <b>Density calculation</b> parameter, the <b>ISO 12213-2</b> option is selected.	Enter amount of substance for the gas mixture.	0 to 100 %	0 %
Mol% i-C <sub>4</sub> H <sub>10</sub>	The following conditions are met: <ul style="list-style-type: none"> <li>▪ In the <b>Select medium</b> parameter, the <b>Gas</b> option is selected.</li> <li>▪ In the <b>Select gas type</b> parameter, the <b>Natural gas</b> option is selected.</li> <li>▪ In the <b>Density calculation</b> parameter, the <b>ISO 12213-2</b> option is selected.</li> </ul>	Enter amount of substance for the gas mixture.	0 to 100 %	0 %
Mol% i-C <sub>5</sub> H <sub>12</sub>	The following conditions are met: <ul style="list-style-type: none"> <li>▪ In the <b>Select medium</b> parameter, the <b>Gas</b> option is selected.</li> <li>▪ In the <b>Select gas type</b> parameter, the <b>Natural gas</b> option is selected.</li> <li>▪ In the <b>Density calculation</b> parameter, the <b>ISO 12213-2</b> option is selected.</li> </ul>	Enter amount of substance for the gas mixture.	0 to 100 %	0 %
Mol% Kr	The following conditions are met: <ul style="list-style-type: none"> <li>▪ In the <b>Select medium</b> parameter, the <b>Gas</b> option is selected.</li> <li>▪ In the <b>Select gas type</b> parameter, the <b>Gas mixture</b> option is selected.</li> <li>▪ In the <b>Gas mixture</b> parameter, the <b>Krypton Kr</b> option is selected.</li> </ul>	Enter amount of substance for the gas mixture.	0 to 100 %	0 %

Parameter	Prerequisite	Description	Selection / User entry	Factory setting
Mol% N2	<p>The following conditions are met:</p> <p>In the <b>Select medium</b> parameter, the <b>Gas</b> option is selected.</p> <ul style="list-style-type: none"> <li>- In the <b>Select gas type</b> parameter, the <b>Gas mixture</b> option is selected and in the <b>Gas mixture</b> parameter, the <b>Nitrogen N2</b> option is selected.</li> </ul> <p>Or</p> <ul style="list-style-type: none"> <li>- In the <b>Select gas type</b> parameter, the <b>Natural gas</b> option is selected and in the <b>Density calculation</b> parameter, the <b>AGA Nx19</b> option or the <b>ISO 12213- 2</b> option is selected.</li> </ul>	Enter amount of substance for the gas mixture.	0 to 100 %	0 %
Mol% n-C10H22	<p>The following conditions are met:</p> <ul style="list-style-type: none"> <li>▪ In the <b>Select medium</b> parameter, the <b>Gas</b> option is selected.</li> <li>▪ In the <b>Select gas type</b> parameter, the <b>Natural gas</b> option is selected.</li> <li>▪ In the <b>Density calculation</b> parameter, the <b>ISO 12213- 2</b> option is selected.</li> </ul>	Enter amount of substance for the gas mixture.	0 to 100 %	0 %
Mol% n-C4H10	<p>The following conditions are met:</p> <ul style="list-style-type: none"> <li>▪ In the <b>Select medium</b> parameter, the <b>Gas</b> option is selected. <ul style="list-style-type: none"> <li>- In the <b>Select gas type</b> parameter, the <b>Gas mixture</b> option is selected and in the <b>Gas mixture</b> parameter, the <b>Butane C4H10</b> option is selected.</li> </ul> </li> </ul> <p>Or</p> <ul style="list-style-type: none"> <li>- In the <b>Select gas type</b> parameter, the <b>Natural gas</b> option is selected and in the <b>Density calculation</b> parameter, the <b>ISO 12213- 2</b> option is selected.</li> </ul> <ul style="list-style-type: none"> <li>▪ Or</li> <li>In the <b>Select medium</b> parameter, the <b>Liquid</b> option is selected and in the <b>Select liquid type</b> parameter, the <b>LPG</b> option is selected.</li> </ul>	Enter amount of substance for the gas mixture.	0 to 100 %	0 %

Parameter	Prerequisite	Description	Selection / User entry	Factory setting
Mol% n-C <sub>5</sub> H <sub>12</sub>	The following conditions are met: <ul style="list-style-type: none"> <li>▪ In the <b>Select medium</b> parameter, the <b>Gas</b> option is selected.</li> <li>▪ In the <b>Select gas type</b> parameter, the <b>Natural gas</b> option is selected.</li> <li>▪ In the <b>Density calculation</b> parameter, the <b>ISO 12213-2</b> option is selected.</li> </ul>	Enter amount of substance for the gas mixture.	0 to 100 %	0 %
Mol% n-C <sub>6</sub> H <sub>14</sub>	The following conditions are met: <ul style="list-style-type: none"> <li>▪ In the <b>Select medium</b> parameter, the <b>Gas</b> option is selected.</li> <li>▪ In the <b>Select gas type</b> parameter, the <b>Natural gas</b> option is selected.</li> <li>▪ In the <b>Density calculation</b> parameter, the <b>ISO 12213-2</b> option is selected.</li> </ul>	Enter amount of substance for the gas mixture.	0 to 100 %	0 %
Mol% n-C <sub>7</sub> H <sub>16</sub>	The following conditions are met: <ul style="list-style-type: none"> <li>▪ In the <b>Select medium</b> parameter, the <b>Gas</b> option is selected.</li> <li>▪ In the <b>Select gas type</b> parameter, the <b>Natural gas</b> option is selected.</li> <li>▪ In the <b>Density calculation</b> parameter, the <b>ISO 12213-2</b> option is selected.</li> </ul>	Enter amount of substance for the gas mixture.	0 to 100 %	0 %
Mol% n-C <sub>8</sub> H <sub>18</sub>	The following conditions are met: <ul style="list-style-type: none"> <li>▪ In the <b>Select medium</b> parameter, the <b>Gas</b> option is selected.</li> <li>▪ In the <b>Select gas type</b> parameter, the <b>Natural gas</b> option is selected.</li> <li>▪ In the <b>Density calculation</b> parameter, the <b>ISO 12213-2</b> option is selected.</li> </ul>	Enter amount of substance for the gas mixture.	0 to 100 %	0 %
Mol% n-C <sub>9</sub> H <sub>20</sub>	The following conditions are met: <ul style="list-style-type: none"> <li>▪ In the <b>Select medium</b> parameter, the <b>Gas</b> option is selected.</li> <li>▪ In the <b>Select gas type</b> parameter, the <b>Natural gas</b> option is selected.</li> <li>▪ In the <b>Density calculation</b> parameter, the <b>ISO 12213-2</b> option is selected.</li> </ul>	Enter amount of substance for the gas mixture.	0 to 100 %	0 %

Parameter	Prerequisite	Description	Selection / User entry	Factory setting
Mol% Ne	The following conditions are met: <ul style="list-style-type: none"> <li>▪ In the <b>Select medium</b> parameter, the <b>Gas</b> option is selected.</li> <li>▪ In the <b>Select gas type</b> parameter, the <b>Gas mixture</b> option is selected.</li> <li>▪ In the <b>Gas mixture</b> parameter, the <b>Neon Ne</b> option is selected.</li> </ul>	Enter amount of substance for the gas mixture.	0 to 100 %	0 %
Mol% NH3	The following conditions are met: <ul style="list-style-type: none"> <li>▪ In the <b>Select medium</b> parameter, the <b>Gas</b> option is selected.</li> <li>▪ In the <b>Select gas type</b> parameter, the <b>Gas mixture</b> option is selected.</li> <li>▪ In the <b>Gas mixture</b> parameter, the <b>Ammonia NH3</b> option is selected.</li> </ul>	Enter amount of substance for the gas mixture.	0 to 100 %	0 %
Mol% O2	The following conditions are met: In the <b>Select medium</b> parameter, the <b>Gas</b> option is selected. – In the <b>Select gas type</b> parameter, the <b>Gas mixture</b> option is selected and in the <b>Gas mixture</b> parameter, the <b>Oxygen O2</b> option is selected. Or – In the <b>Select gas type</b> parameter, the <b>Natural gas</b> option is selected and in the <b>Density calculation</b> parameter, the <b>ISO 12213-2</b> option is selected.	Enter amount of substance for the gas mixture.	0 to 100 %	0 %
Mol% SO2	The following conditions are met: <ul style="list-style-type: none"> <li>▪ In the <b>Select medium</b> parameter, the <b>Gas</b> option is selected.</li> <li>▪ In the <b>Select gas type</b> parameter, the <b>Gas mixture</b> option is selected.</li> <li>▪ In the <b>Gas mixture</b> parameter, the <b>Sulfur dioxide SO2</b> option is selected.</li> </ul>	Enter amount of substance for the gas mixture.	0 to 100 %	0 %
Mol% Xe	The following conditions are met: <ul style="list-style-type: none"> <li>▪ In the <b>Select medium</b> parameter, the <b>Gas</b> option is selected.</li> <li>▪ In the <b>Select gas type</b> parameter, the <b>Gas mixture</b> option is selected.</li> <li>▪ In the <b>Gas mixture</b> parameter, the <b>Xenon Xe</b> option is selected.</li> </ul>	Enter amount of substance for the gas mixture.	0 to 100 %	0 %

Parameter	Prerequisite	Description	Selection / User entry	Factory setting
Mol% other gas	The following conditions are met: <ul style="list-style-type: none"> <li>▪ In the <b>Select medium</b> parameter, the <b>Gas</b> option is selected.</li> <li>▪ In the <b>Select gas type</b> parameter, the <b>Gas mixture</b> option is selected.</li> <li>▪ In the <b>Gas mixture</b> parameter, the <b>Others</b> option is selected.</li> </ul>	Enter amount of substance for the gas mixture.	0 to 100 %	0 %
Relative humidity	The following conditions are met: <ul style="list-style-type: none"> <li>▪ In the <b>Select medium</b> parameter, the <b>Gas</b> option is selected.</li> <li>▪ In the <b>Select gas type</b> parameter, the <b>Air</b> option is selected.</li> </ul>	Enter humidity content of air in %.	0 to 100 %	0 %

### 10.6.2 Performing external compensation

The **External compensation** submenu contains parameters which can be used to enter external or fixed values. These values are used for internal calculations.

 The **Fixed process pressure** parameter is set to the value **0 bar abs.** (ex works). In this case, the measuring device ignores the pressure read in via PROFIBUS PA. For the measuring device to use the external (read-in) pressure, a value > 0 bar abs. must be entered in the **Fixed process pressure** parameter.





For a detailed description of how to calculate the mass flow and energy flow:  
 →  186





#### Navigation

"Expert" menu → Sensor → External compensation

▶ External compensation

## Parameter overview with brief description

Parameter	Prerequisite	Description	Selection / User entry	Factory setting
External value	For the following order code: "Sensor version", option "Mass flow"	Assign variable from external device to process variable. <i>Selection</i> <b>NOTE!</b> <b>If the pressure option is selected, the pressure is read in externally via a pressure transmitter.</b> The pressure must be read in with the Pascal unit so that pressure compensation can be read in correctly. ▶ Select the <b>Pa</b> option in the <b>Pressure unit</b> parameter.  For detailed information on the calculation of the measured variables with steam: →  187  For detailed information on setting the parameter in steam applications, see the Special Documentation for the <b>Wet Steam Detection and Wet Steam Measurement</b> →  208 application package.	<ul style="list-style-type: none"> <li>▪ Off</li> <li>▪ Pressure</li> <li>▪ Relative pressure</li> <li>▪ Density</li> <li>▪ Temperature</li> <li>▪ 2nd temperature delta heat</li> </ul>	Off
Atmospheric pressure	In the <b>External value</b> parameter, the <b>Relative pressure</b> option is selected.	Enter atmospheric pressure value to be used for pressure correction. <i>Dependency</i> The unit is taken from the <b>Pressure unit</b> parameter	0 to 250 bar	1.01325 bar
Delta heat calculation	The <b>Delta heat calculation</b> parameter is visible.	Calculates the transferred heat of a heat exchanger (= delta heat).	<ul style="list-style-type: none"> <li>▪ Off</li> <li>▪ Device on cold side</li> <li>▪ Device on warm side</li> </ul>	Device on warm side
Fixed density	For the following order code: "Sensor version", option "Volume flow"	Enter fixed value for medium density. <i>Dependency</i> The unit is taken from the <b>Density unit</b> parameter.	0.01 to 15 000 kg/m <sup>3</sup>	1 000 kg/m <sup>3</sup>
Fixed temperature	–	Enter a fixed value for process temperature. <i>Dependency</i> The unit is taken from the <b>Temperature unit</b> parameter	–200 to 450 °C	20 °C
2nd temperature delta heat	The <b>2nd temperature delta heat</b> parameter is visible.	Enter 2nd temperature value to calculate the delta heat. <i>Dependency</i> The unit is taken from the <b>Temperature unit</b> parameter	–200 to 450 °C	20 °C

Parameter	Prerequisite	Description	Selection / User entry	Factory setting
Fixed process pressure	<p>The following conditions are met:</p> <ul style="list-style-type: none"> <li>Order code for "Sensor version", option "Mass flow (integrated temperature measurement)"</li> <li>In the <b>External value</b> parameter (→ 102), the <b>Pressure</b> option is not selected.</li> </ul>	<p>Enter fixed value for process pressure.</p> <p><i>Dependency</i> The unit is taken from the <b>Pressure unit</b> parameter</p> <p> For detailed information on the calculation of the measured variables with steam: → 187</p> <p> For detailed information on setting the parameter in steam applications, see the Special Documentation for the <b>Wet Steam Detection</b> and <b>Wet Steam Measurement</b> → 208 application package.</p>	0 to 250 bar abs.	0 bar abs.
Steam quality	<p>The following conditions are met:</p> <ul style="list-style-type: none"> <li>Order code for "Application package":                             <ul style="list-style-type: none"> <li>Option ES "Wet steam detection"</li> <li>Option EU "Wet steam measurement"</li> </ul> </li> <li>In the <b>Select medium</b> parameter, the <b>Steam</b> option is selected.</li> </ul> <p> The software options currently enabled are displayed in the <b>Software option overview</b> parameter.</p>	<p>Select compensation mode for steam quality.</p> <p> For detailed information on setting the parameter in steam applications, see the Special Documentation for the <b>Wet Steam Detection</b> and <b>Wet Steam Measurement</b> → 208 application package.</p>	<ul style="list-style-type: none"> <li>Fixed value</li> <li>Calculated value</li> </ul>	Fixed value
Steam quality value	<p>The following conditions are met:</p> <ul style="list-style-type: none"> <li>In the <b>Select medium</b> parameter, the <b>Steam</b> option is selected.</li> <li>In the <b>Steam quality</b> parameter, the <b>Fixed value</b> option is selected.</li> </ul>	<p>Enter fixed value for steam quality.</p> <p> For detailed information on setting the parameter in steam applications, see the Special Documentation for the <b>Wet Steam Detection</b> and <b>Wet Steam Measurement</b> → 208 application package.</p>	0 to 100 %	100 %

### 10.6.3 Carrying out a sensor adjustment

The **Sensor adjustment** submenu contains parameters that pertain to the functionality of the sensor.

#### Navigation

"Setup" menu → Advanced setup → Sensor adjustment

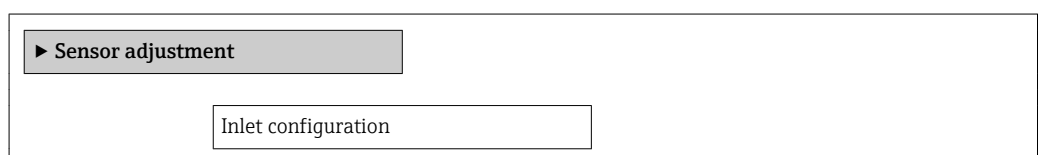

Inlet run
Mating pipe diameter
Installation factor

### Parameter overview with brief description

Parameter	Prerequisite	Description	Selection / User entry	Factory setting
Inlet configuration	The <b>inlet run correction</b> feature: <ul style="list-style-type: none"> <li>■ Is a standard feature and can only be used in Prowirl F 200.</li> <li>■ Can be used for the following pressure ratings and nominal diameters: DN 15 to 150 (1 to 6") <ul style="list-style-type: none"> <li>- EN (DIN)</li> <li>- ASME B16.5, Sch. 40/80</li> </ul> </li> </ul>	Select inlet configuration.	<ul style="list-style-type: none"> <li>■ Off</li> <li>■ Single elbow</li> <li>■ Double elbow</li> <li>■ Double elbow 3D</li> <li>■ Reduction</li> </ul>	Off
Inlet run	The <b>inlet run correction</b> feature: <ul style="list-style-type: none"> <li>■ Is a standard feature and can only be used in Prowirl F 200.</li> <li>■ Can be used for the following pressure ratings and nominal diameters: DN 15 to 150 (1 to 6") <ul style="list-style-type: none"> <li>- EN (DIN)</li> <li>- ASME B16.5, Sch. 40/80</li> </ul> </li> </ul>	Define length of the straight inlet run.  <i>Dependency</i> The unit is taken from the <b>Length unit</b> parameter	0 to 20 m	0 m
Mating pipe diameter	-	Enter diameter of mating pipe to enable diameter mismatch correction.  Detailed information on diameter mismatch correction: <i>Dependency</i> The unit is taken from the <b>Length unit</b> parameter.	0 to 1 m (0 to 3 ft) Input value = 0: Diameter mismatch correction is disabled.	Country-specific: <ul style="list-style-type: none"> <li>■ 0 m</li> <li>■ 0 ft</li> </ul>
Installation factor	-	Enter factor to adjust for installation conditions.	Positive floating-point number	1.0

### 10.6.4 Configuring the pulse/frequency/switch output

The **Pulse/frequency/switch output** wizard guides you systematically through all the parameters that can be set for configuring the selected output type.



### Configuring the pulse output

#### Navigation

"Setup" menu → Advanced setup → Pulse/frequency/switch output

#### Structure of the wizard for the pulse output

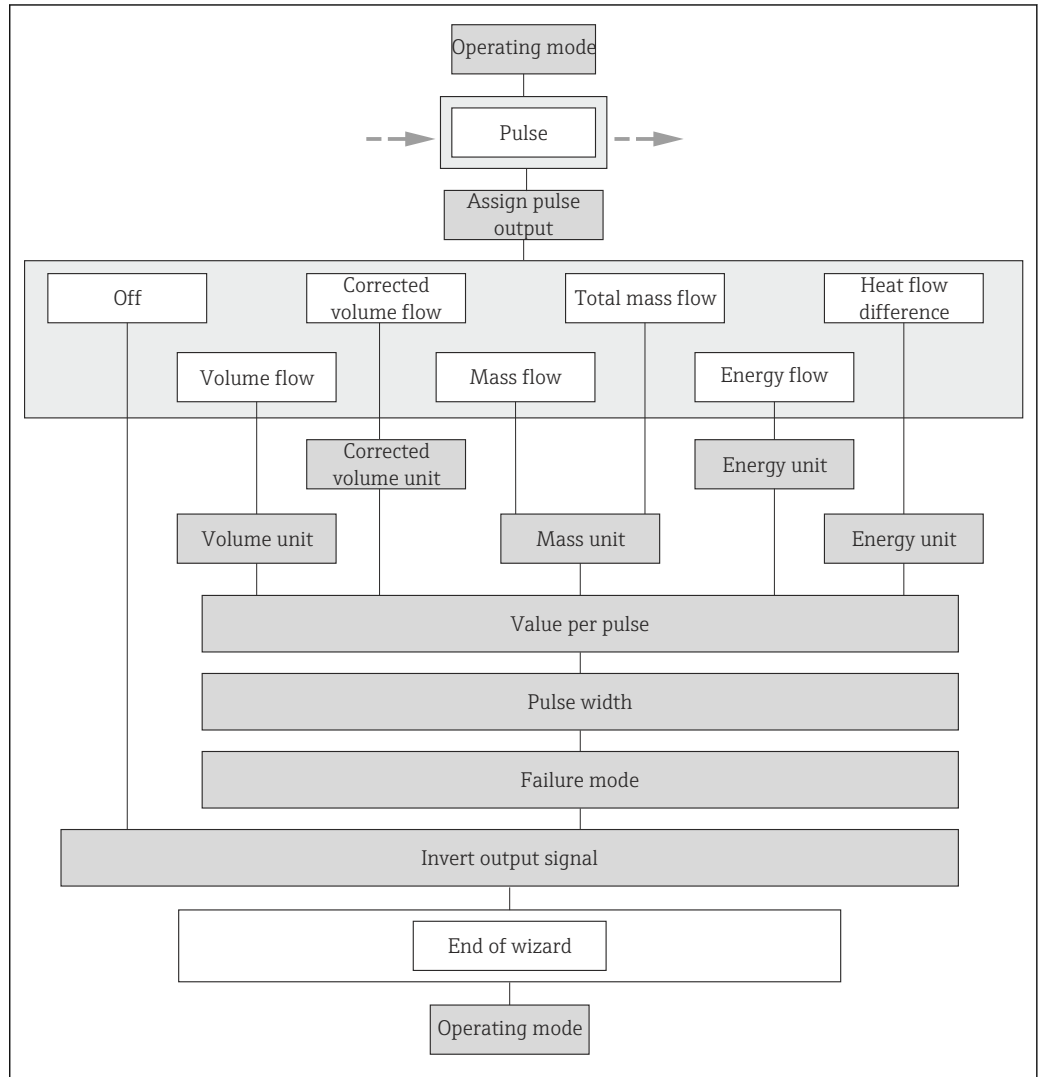

A0020792-EN

26 "Pulse/frequency/switch output" wizard in the "Advanced setup" submenu: "Operating mode" parameter "Pulse" option

## Parameter overview with brief description

Parameter	Prerequisite	Description	Selection / User entry	Factory setting
Operating mode	–	Define the output as a pulse, frequency or switch output.	<ul style="list-style-type: none"> <li>■ Pulse</li> <li>■ Frequency</li> <li>■ Switch</li> </ul>	Pulse
Assign pulse output	The <b>Pulse</b> option is selected in the <b>Operating mode</b> parameter.	Select process variable for pulse output.	<ul style="list-style-type: none"> <li>■ Off</li> <li>■ Volume flow</li> <li>■ Corrected volume flow</li> <li>■ Mass flow</li> <li>■ Total mass flow *</li> <li>■ Energy flow *</li> <li>■ Heat flow difference *</li> </ul>	Volume flow
Mass unit	–	Select mass unit.	Unit choose list	Country-specific: <ul style="list-style-type: none"> <li>■ kg</li> <li>■ lb</li> </ul>
Volume unit	–	Select volume unit.	Unit choose list	Country-specific: <ul style="list-style-type: none"> <li>■ m<sup>3</sup></li> <li>■ ft<sup>3</sup></li> </ul>
Corrected volume unit	–	Select corrected volume unit.	Unit choose list	Country-specific: <ul style="list-style-type: none"> <li>■ Nm<sup>3</sup></li> <li>■ Sft<sup>3</sup></li> </ul>
Energy unit	For the following order code: "Sensor version", option "Mass flow"	Select energy unit.	Unit choose list	Country-specific: <ul style="list-style-type: none"> <li>■ kWh</li> <li>■ Btu</li> </ul>
Value per pulse	The <b>Pulse</b> option is selected in the <b>Operating mode</b> parameter, and one of the following options is selected in the <b>Assign pulse output</b> parameter (→ 106): <ul style="list-style-type: none"> <li>■ Volume flow</li> <li>■ Corrected volume flow</li> <li>■ Mass flow</li> <li>■ Total mass flow *</li> <li>■ Energy flow *</li> <li>■ Heat flow difference *</li> </ul>	Enter measured value at which a pulse is output.	Positive floating-point number	Depends on country and nominal diameter
Pulse width	In the <b>Operating mode</b> parameter, the <b>Pulse</b> option is selected and one of the following options is selected in the <b>Assign pulse output</b> parameter (→ 106): <ul style="list-style-type: none"> <li>■ Volume flow</li> <li>■ Corrected volume flow</li> <li>■ Mass flow</li> <li>■ Total mass flow *</li> <li>■ Energy flow *</li> <li>■ Heat flow difference *</li> </ul>	Define time width of the output pulse.	5 to 2 000 ms	100 ms

Parameter	Prerequisite	Description	Selection / User entry	Factory setting
Failure mode	In the <b>Operating mode</b> parameter, the <b>Pulse</b> option is selected and one of the following options is selected in the <b>Assign pulse output</b> parameter (→  106): <ul style="list-style-type: none"> <li>■ Volume flow</li> <li>■ Corrected volume flow</li> <li>■ Mass flow</li> <li>■ Total mass flow *</li> <li>■ Energy flow *</li> <li>■ Heat flow difference *</li> </ul>	Define output behavior in alarm condition.	<ul style="list-style-type: none"> <li>■ Actual value</li> <li>■ No pulses</li> </ul>	No pulses
Invert output signal	–	Invert the output signal.	<ul style="list-style-type: none"> <li>■ No</li> <li>■ Yes</li> </ul>	No

\* Visibility depends on order options or device settings

### Configuring the frequency output

#### Navigation

"Setup" menu → Advanced setup → Pulse/frequency/switch output

#### Structure of the wizard for the frequency output

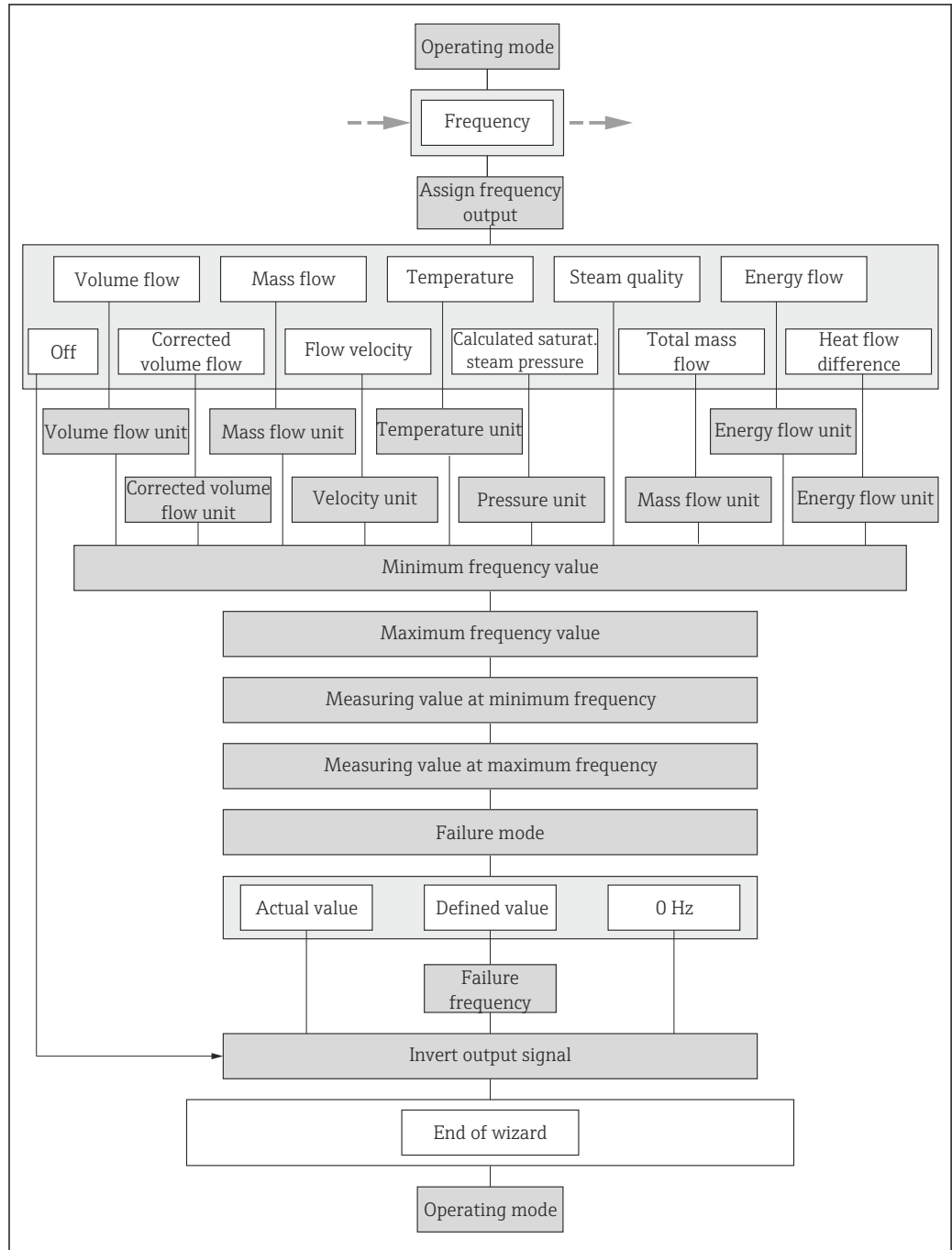



A0020789-EN

27 "Pulse/frequency/switch output" wizard in the "Advanced setup" submenu: "Operating mode" parameter "Frequency" option

## Parameter overview with brief description

Parameter	Prerequisite	Description	Selection / User entry	Factory setting
Operating mode	–	Define the output as a pulse, frequency or switch output.	<ul style="list-style-type: none"> <li>■ Pulse</li> <li>■ Frequency</li> <li>■ Switch</li> </ul>	Pulse
Assign frequency output	The <b>Frequency</b> option is selected in the <b>Operating mode</b> parameter (→ 106).	Select process variable for frequency output.	<ul style="list-style-type: none"> <li>■ Off</li> <li>■ Volume flow</li> <li>■ Corrected volume flow</li> <li>■ Mass flow</li> <li>■ Flow velocity</li> <li>■ Temperature</li> <li>■ Calculated saturated steam pressure<sup>*</sup></li> <li>■ Steam quality<sup>*</sup></li> <li>■ Total mass flow<sup>*</sup></li> <li>■ Energy flow<sup>*</sup></li> <li>■ Heat flow difference<sup>*</sup></li> </ul>	Off
Mass flow unit	–	Select mass flow unit. <i>Effect</i> The selected unit applies for: <ul style="list-style-type: none"> <li>■ Output</li> <li>■ Low flow cut off</li> <li>■ Simulation process variable</li> </ul>	Unit choose list	Country-specific: <ul style="list-style-type: none"> <li>■ kg/h</li> <li>■ lb/min</li> </ul>
Volume flow unit	–	Select volume flow unit. <i>Effect</i> The selected unit applies for: <ul style="list-style-type: none"> <li>■ Output</li> <li>■ Low flow cut off</li> <li>■ Simulation process variable</li> </ul>	Unit choose list	Country-specific: <ul style="list-style-type: none"> <li>■ m<sup>3</sup>/h</li> <li>■ ft<sup>3</sup>/min</li> </ul>
Corrected volume flow unit	–	Select corrected volume flow unit. <i>Effect</i> The selected unit applies for: Corrected volume flow	Unit choose list	Country-specific: <ul style="list-style-type: none"> <li>■ Nm<sup>3</sup>/h</li> <li>■ Sft<sup>3</sup>/h</li> </ul>
Energy flow unit	For the following order code: "Sensor version", option "Mass flow"	Select energy flow unit. <i>Result</i> The selected unit applies for: <ul style="list-style-type: none"> <li>■ Outputs</li> <li>■ Low flow cut off</li> </ul>	Unit choose list	Country-specific: <ul style="list-style-type: none"> <li>■ kW</li> <li>■ Btu/h</li> </ul>
Pressure unit	For the following order code: "Sensor version", option "Mass flow"	Select process pressure unit. <i>Effect</i> The unit is taken from the: <ul style="list-style-type: none"> <li>■ Calculated saturated steam pressure</li> <li>■ Atmospheric pressure</li> <li>■ Maximum value</li> <li>■ Fixed process pressure</li> <li>■ Pressure</li> <li>■ Reference pressure</li> </ul>	Unit choose list	Country-specific: <ul style="list-style-type: none"> <li>■ bar</li> <li>■ psi</li> </ul>
Velocity unit	–	Select velocity unit. <i>Result</i> The selected unit applies for: <ul style="list-style-type: none"> <li>■ Flow velocity</li> <li>■ Maximum value</li> </ul>	Unit choose list	Country-specific: <ul style="list-style-type: none"> <li>■ m/s</li> <li>■ ft/s</li> </ul>

Parameter	Prerequisite	Description	Selection / User entry	Factory setting
Temperature unit	–	Select temperature unit. <i>Effect</i> The selected unit applies for: <ul style="list-style-type: none"> <li>■ Temperature</li> <li>■ Maximum value</li> <li>■ Minimum value</li> <li>■ Average value</li> <li>■ Maximum value</li> <li>■ Minimum value</li> <li>■ Maximum value</li> <li>■ Minimum value</li> <li>■ 2nd temperature delta heat</li> <li>■ Fixed temperature</li> <li>■ Reference combustion temperature</li> <li>■ Reference temperature</li> <li>■ Saturation temperature</li> </ul>	Unit choose list	Country-specific: <ul style="list-style-type: none"> <li>■ °C</li> <li>■ °F</li> </ul>
Minimum frequency value	The <b>Frequency</b> option is selected in the <b>Operating mode</b> parameter, and one of the following options is selected in the <b>Assign frequency output</b> parameter (→  109): <ul style="list-style-type: none"> <li>■ Volume flow</li> <li>■ Corrected volume flow</li> <li>■ Mass flow</li> <li>■ Flow velocity</li> <li>■ Temperature</li> <li>■ Calculated saturated steam pressure *</li> <li>■ Steam quality *</li> <li>■ Total mass flow *</li> <li>■ Energy flow *</li> <li>■ Heat flow difference *</li> </ul>	Enter minimum frequency.	0 to 1 000 Hz	0 Hz
Maximum frequency value	The <b>Frequency</b> option is selected in the <b>Operating mode</b> parameter, and one of the following options is selected in the <b>Assign frequency output</b> parameter (→  109): <ul style="list-style-type: none"> <li>■ Volume flow</li> <li>■ Corrected volume flow</li> <li>■ Mass flow</li> <li>■ Flow velocity</li> <li>■ Temperature</li> <li>■ Calculated saturated steam pressure *</li> <li>■ Steam quality *</li> <li>■ Total mass flow *</li> <li>■ Energy flow *</li> <li>■ Heat flow difference *</li> </ul>	Enter maximum frequency.	0 to 1 000 Hz	1 000 Hz

Parameter	Prerequisite	Description	Selection / User entry	Factory setting
Measuring value at minimum frequency	The <b>Frequency</b> option is selected in the <b>Operating mode</b> parameter, and one of the following options is selected in the <b>Assign frequency output</b> parameter (→ 109): <ul style="list-style-type: none"> <li>▪ Volume flow</li> <li>▪ Corrected volume flow</li> <li>▪ Mass flow</li> <li>▪ Flow velocity</li> <li>▪ Temperature</li> <li>▪ Calculated saturated steam pressure *</li> <li>▪ Steam quality *</li> <li>▪ Total mass flow *</li> <li>▪ Energy flow *</li> <li>▪ Heat flow difference *</li> </ul>	Enter measured value for minimum frequency.	Signed floating-point number	Depends on country and nominal diameter
Measuring value at maximum frequency	The <b>Frequency</b> option is selected in the <b>Operating mode</b> parameter, and one of the following options is selected in the <b>Assign frequency output</b> parameter (→ 109): <ul style="list-style-type: none"> <li>▪ Volume flow</li> <li>▪ Corrected volume flow</li> <li>▪ Mass flow</li> <li>▪ Flow velocity</li> <li>▪ Temperature</li> <li>▪ Calculated saturated steam pressure *</li> <li>▪ Steam quality *</li> <li>▪ Total mass flow *</li> <li>▪ Energy flow *</li> <li>▪ Heat flow difference *</li> </ul>	Enter measured value for maximum frequency.	Signed floating-point number	Depends on country and nominal diameter
Failure mode	The <b>Frequency</b> option is selected in the <b>Operating mode</b> parameter (→ 106), and one of the following options is selected in the <b>Assign frequency output</b> parameter (→ 109): <ul style="list-style-type: none"> <li>▪ Volume flow</li> <li>▪ Corrected volume flow</li> <li>▪ Mass flow</li> <li>▪ Flow velocity</li> <li>▪ Temperature</li> <li>▪ Calculated saturated steam pressure *</li> <li>▪ Steam quality *</li> <li>▪ Total mass flow *</li> <li>▪ Energy flow *</li> <li>▪ Heat flow difference *</li> </ul>	Define output behavior in alarm condition.	<ul style="list-style-type: none"> <li>▪ Actual value</li> <li>▪ Defined value</li> <li>▪ 0 Hz</li> </ul>	0 Hz

Parameter	Prerequisite	Description	Selection / User entry	Factory setting
Failure frequency	The <b>Frequency</b> option is selected in the <b>Operating mode</b> parameter (→ 106), and one of the following options is selected in the <b>Assign frequency output</b> parameter (→ 109): <ul style="list-style-type: none"> <li>▪ Volume flow</li> <li>▪ Corrected volume flow</li> <li>▪ Mass flow</li> <li>▪ Flow velocity</li> <li>▪ Temperature</li> <li>▪ Calculated saturated steam pressure *</li> <li>▪ Steam quality *</li> <li>▪ Total mass flow *</li> <li>▪ Energy flow *</li> <li>▪ Heat flow difference *</li> </ul>	Enter frequency output value in alarm condition.	0.0 to 1 250.0 Hz	0.0 Hz
Invert output signal	–	Invert the output signal.	<ul style="list-style-type: none"> <li>▪ No</li> <li>▪ Yes</li> </ul>	No

\* Visibility depends on order options or device settings

### Configuring the switch output

#### Navigation

"Setup" menu → Advanced setup → Pulse/frequency/switch output

#### Structure of the wizard for the switch output

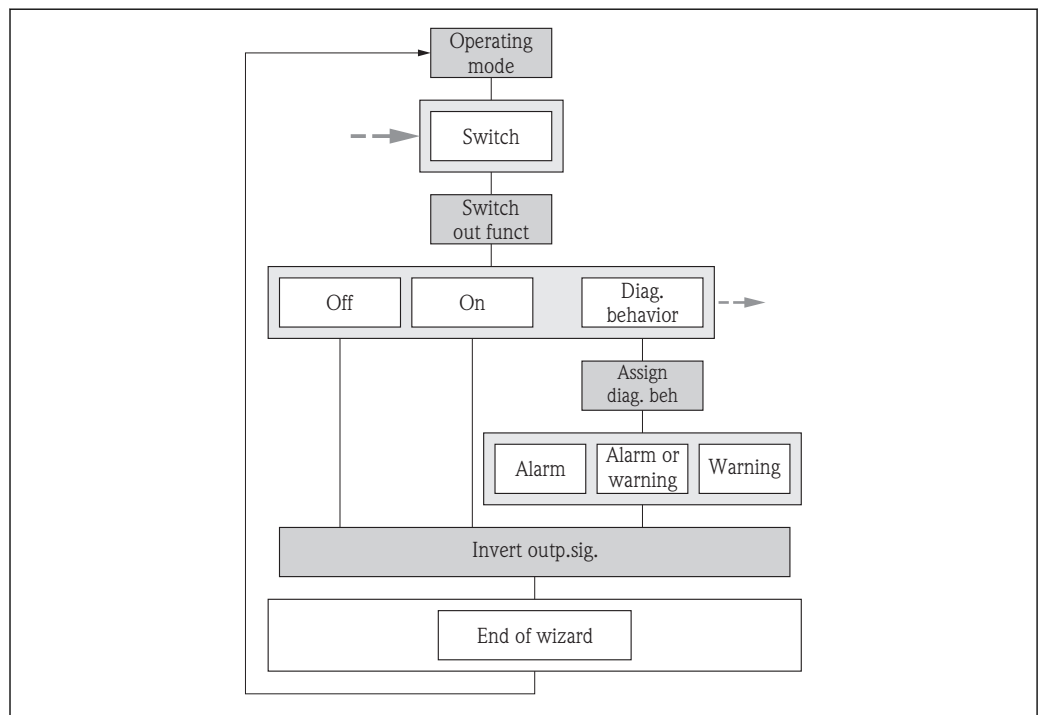

A0017439-EN

28 "Pulse/frequency/switch output" wizard in the "Advanced setup" submenu: "Operating mode" parameter "Switch" option (part 1)



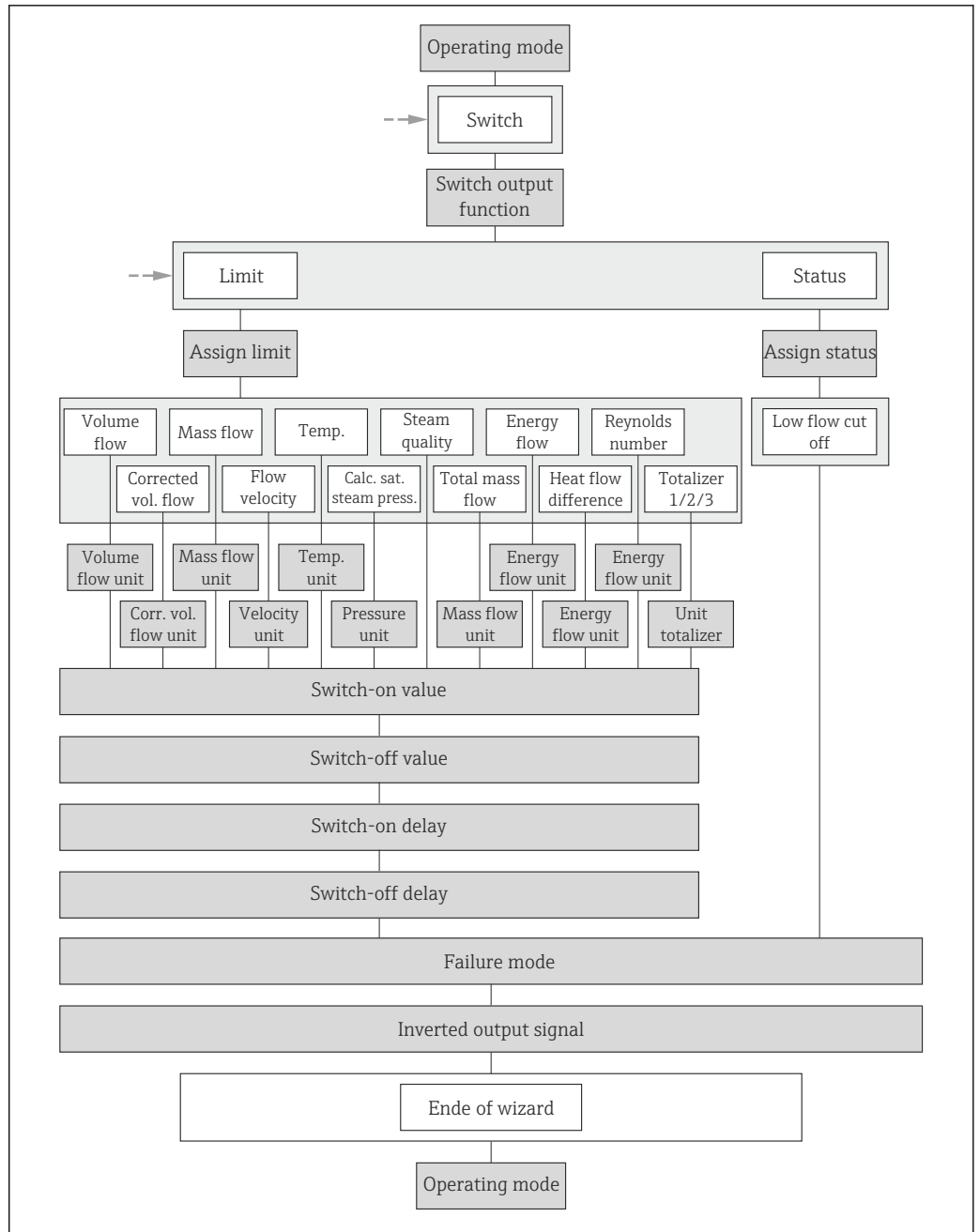

A0020794-EN

29 "Pulse/frequency/switch output" wizard in the "Advanced setup" submenu: "Operating mode" parameter "Switch" option (part 2)

**Parameter overview with brief description**

Parameter	Prerequisite	Description	Selection / User entry	Factory setting
Operating mode	-	Define the output as a pulse, frequency or switch output.	<ul style="list-style-type: none"> <li>■ Pulse</li> <li>■ Frequency</li> <li>■ Switch</li> </ul>	Pulse
Switch output function	The <b>Switch</b> option is selected in the <b>Operating mode</b> parameter.	Select function for switch output.	<ul style="list-style-type: none"> <li>■ Off</li> <li>■ On</li> <li>■ Diagnostic behavior</li> <li>■ Limit</li> <li>■ Status</li> </ul>	Off

Parameter	Prerequisite	Description	Selection / User entry	Factory setting
Assign diagnostic behavior	<ul style="list-style-type: none"> <li>The <b>Switch</b> option is selected in the <b>Operating mode</b> parameter.</li> <li>The <b>Diagnostic behavior</b> option is selected in the <b>Switch output function</b> parameter.</li> </ul>	Select diagnostic behavior for switch output.	<ul style="list-style-type: none"> <li>Alarm</li> <li>Alarm or warning</li> <li>Warning</li> </ul>	Alarm
Assign limit	<ul style="list-style-type: none"> <li>The <b>Switch</b> option is selected in the <b>Operating mode</b> parameter.</li> <li>The <b>Limit</b> option is selected in the <b>Switch output function</b> parameter.</li> </ul>	Select process variable for limit function.	<ul style="list-style-type: none"> <li>Volume flow</li> <li>Corrected volume flow</li> <li>Mass flow</li> <li>Flow velocity</li> <li>Temperature</li> <li>Calculated saturated steam pressure *</li> <li>Steam quality *</li> <li>Total mass flow *</li> <li>Energy flow *</li> <li>Heat flow difference *</li> <li>Reynolds number *</li> <li>Totalizer 1</li> <li>Totalizer 2</li> <li>Totalizer 3</li> </ul>	Volume flow
Assign flow direction check	<ul style="list-style-type: none"> <li>The <b>Switch</b> option is selected in the <b>Operating mode</b> parameter.</li> <li>The <b>Flow direction check</b> option is selected in the <b>Switch output function</b> parameter.</li> </ul>	Select process variable for flow direction monitoring.	<ul style="list-style-type: none"> <li>Off</li> <li>Volume flow</li> <li>Mass flow</li> <li>Corrected volume flow</li> </ul>	Volume flow
Assign status	<ul style="list-style-type: none"> <li>The <b>Switch</b> option is selected in the <b>Operating mode</b> parameter.</li> <li>The <b>Status</b> option is selected in the <b>Switch output function</b> parameter.</li> </ul>	Select device status for switch output.	<ul style="list-style-type: none"> <li>Low flow cut off</li> <li>Digital output 2</li> </ul>	Low flow cut off
Mass flow unit	–	Select mass flow unit. <i>Effect</i> The selected unit applies for: <ul style="list-style-type: none"> <li>Output</li> <li>Low flow cut off</li> <li>Simulation process variable</li> </ul>	Unit choose list	Country-specific: <ul style="list-style-type: none"> <li>kg/h</li> <li>lb/min</li> </ul>
Volume flow unit	–	Select volume flow unit. <i>Effect</i> The selected unit applies for: <ul style="list-style-type: none"> <li>Output</li> <li>Low flow cut off</li> <li>Simulation process variable</li> </ul>	Unit choose list	Country-specific: <ul style="list-style-type: none"> <li>m<sup>3</sup>/h</li> <li>ft<sup>3</sup>/min</li> </ul>
Corrected volume flow unit	–	Select corrected volume flow unit. <i>Effect</i> The selected unit applies for: Corrected volume flow	Unit choose list	Country-specific: <ul style="list-style-type: none"> <li>Nm<sup>3</sup>/h</li> <li>Sft<sup>3</sup>/h</li> </ul>
Energy flow unit	For the following order code: "Sensor version", option "Mass flow"	Select energy flow unit. <i>Result</i> The selected unit applies for: <ul style="list-style-type: none"> <li>Outputs</li> <li>Low flow cut off</li> </ul>	Unit choose list	Country-specific: <ul style="list-style-type: none"> <li>kW</li> <li>Btu/h</li> </ul>

Parameter	Prerequisite	Description	Selection / User entry	Factory setting
Pressure unit	For the following order code: "Sensor version", option "Mass flow"	Select process pressure unit. <i>Effect</i> The unit is taken from the: <ul style="list-style-type: none"> <li>▪ Calculated saturated steam pressure</li> <li>▪ Atmospheric pressure</li> <li>▪ Maximum value</li> <li>▪ Fixed process pressure</li> <li>▪ Pressure</li> <li>▪ Reference pressure</li> </ul>	Unit choose list	Country-specific: <ul style="list-style-type: none"> <li>▪ bar</li> <li>▪ psi</li> </ul>
Velocity unit	–	Select velocity unit. <i>Result</i> The selected unit applies for: <ul style="list-style-type: none"> <li>▪ Flow velocity</li> <li>▪ Maximum value</li> </ul>	Unit choose list	Country-specific: <ul style="list-style-type: none"> <li>▪ m/s</li> <li>▪ ft/s</li> </ul>
Unit totalizer	One of the following options is selected in the <b>Assign process variable</b> parameter of the <b>Totalizer 1 to 3</b> submenu: <ul style="list-style-type: none"> <li>▪ Volume flow</li> <li>▪ Corrected volume flow</li> <li>▪ Mass flow</li> <li>▪ Total mass flow *</li> <li>▪ Condensate mass flow *</li> <li>▪ Energy flow *</li> <li>▪ Heat flow difference *</li> </ul>	Select process variable totalizer unit.	Unit choose list	Country-specific: <ul style="list-style-type: none"> <li>▪ m<sup>3</sup></li> <li>▪ ft<sup>3</sup></li> </ul>
Temperature unit	–	Select temperature unit. <i>Effect</i> The selected unit applies for: <ul style="list-style-type: none"> <li>▪ Temperature</li> <li>▪ Maximum value</li> <li>▪ Minimum value</li> <li>▪ Average value</li> <li>▪ Maximum value</li> <li>▪ Minimum value</li> <li>▪ Maximum value</li> <li>▪ Minimum value</li> <li>▪ 2nd temperature delta heat</li> <li>▪ Fixed temperature</li> <li>▪ Reference combustion temperature</li> <li>▪ Reference temperature</li> <li>▪ Saturation temperature</li> </ul>	Unit choose list	Country-specific: <ul style="list-style-type: none"> <li>▪ °C</li> <li>▪ °F</li> </ul>
Switch-on value	<ul style="list-style-type: none"> <li>▪ The <b>Switch</b> option is selected in the <b>Operating mode</b> parameter.</li> <li>▪ The <b>Limit</b> option is selected in the <b>Switch output function</b> parameter.</li> </ul>	Enter measured value for the switch-on point.	Signed floating-point number	Country-specific: <ul style="list-style-type: none"> <li>▪ 0 m<sup>3</sup>/h</li> <li>▪ 0 ft<sup>3</sup>/h</li> </ul>
Switch-off value	<ul style="list-style-type: none"> <li>▪ The <b>Switch</b> option is selected in the <b>Operating mode</b> parameter.</li> <li>▪ The <b>Limit</b> option is selected in the <b>Switch output function</b> parameter.</li> </ul>	Enter measured value for the switch-off point.	Signed floating-point number	Country-specific: <ul style="list-style-type: none"> <li>▪ 0 m<sup>3</sup>/h</li> <li>▪ 0 ft<sup>3</sup>/h</li> </ul>
Switch-on delay	<ul style="list-style-type: none"> <li>▪ The <b>Switch</b> option is selected in the <b>Operating mode</b> parameter.</li> <li>▪ The <b>Limit</b> option is selected in the <b>Switch output function</b> parameter.</li> </ul>	Define delay for the switch-on of status output.	0.0 to 100.0 s	0.0 s

Parameter	Prerequisite	Description	Selection / User entry	Factory setting
Switch-off delay	<ul style="list-style-type: none"> <li>▪ The <b>Switch</b> option is selected in the <b>Operating mode</b> parameter.</li> <li>▪ The <b>Limit</b> option is selected in the <b>Switch output function</b> parameter.</li> </ul>	Define delay for the switch-off of status output.	0.0 to 100.0 s	0.0 s
Failure mode	–	Define output behavior in alarm condition.	<ul style="list-style-type: none"> <li>▪ Actual status</li> <li>▪ Open</li> <li>▪ Closed</li> </ul>	Open
Invert output signal	–	Invert the output signal.	<ul style="list-style-type: none"> <li>▪ No</li> <li>▪ Yes</li> </ul>	No

\* Visibility depends on order options or device settings

### 10.6.5 Configuring the totalizer

In the "**Totalizer 1 to 3**" submenu the individual totalizer can be configured.

#### Navigation

"Setup" menu → Advanced setup → Totalizer 1 to 3

▶ Totalizer 1 to 3

Assign process variable

Unit totalizer

Control Totalizer 1 to 3

Totalizer operation mode

Failure mode

## Parameter overview with brief description

Parameter	Prerequisite	Description	Selection	Factory setting
Assign process variable	–	Select process variable for totalizer.	<ul style="list-style-type: none"> <li>■ Volume flow</li> <li>■ Mass flow</li> <li>■ Corrected volume flow</li> <li>■ Total mass flow *</li> <li>■ Condensate mass flow *</li> <li>■ Energy flow *</li> <li>■ Heat flow difference *</li> </ul>	<ul style="list-style-type: none"> <li>■ Totalizer 1: Volume flow</li> <li>■ Totalizer 2: Mass flow</li> <li>■ Totalizer 3: Corrected volume flow</li> </ul>
Unit totalizer	In the <b>Assign process variable</b> parameter, one of the following options is selected: <ul style="list-style-type: none"> <li>■ Volume flow</li> <li>■ Mass flow</li> <li>■ Corrected volume flow</li> <li>■ Total mass flow *</li> <li>■ Condensate mass flow *</li> <li>■ Energy flow *</li> <li>■ Heat flow difference *</li> </ul>	Select the unit for the process variable of the totalizer.	Unit choose list	m <sup>3</sup>
Control Totalizer 1 to 3	In the <b>Assign process variable</b> parameter, one of the following options is selected: <ul style="list-style-type: none"> <li>■ Volume flow</li> <li>■ Mass flow</li> <li>■ Corrected volume flow</li> <li>■ Total mass flow *</li> <li>■ Condensate mass flow *</li> <li>■ Energy flow *</li> <li>■ Heat flow difference *</li> </ul>	Control totalizer value.	<ul style="list-style-type: none"> <li>■ Totalize</li> <li>■ Reset + hold</li> <li>■ Preset + hold</li> </ul>	Totalize
Totalizer operation mode	In the <b>Assign process variable</b> parameter, one of the following options is selected: <ul style="list-style-type: none"> <li>■ Volume flow</li> <li>■ Mass flow</li> <li>■ Corrected volume flow</li> <li>■ Total mass flow *</li> <li>■ Condensate mass flow *</li> <li>■ Energy flow *</li> <li>■ Heat flow difference *</li> </ul>	Select totalizer calculation mode.	<ul style="list-style-type: none"> <li>■ Net flow total</li> <li>■ Forward flow total</li> <li>■ Reverse flow total</li> <li>■ Last valid value</li> </ul>	Net flow total
Failure mode	In the <b>Assign process variable</b> parameter, one of the following options is selected: <ul style="list-style-type: none"> <li>■ Volume flow</li> <li>■ Mass flow</li> <li>■ Corrected volume flow</li> <li>■ Total mass flow *</li> <li>■ Condensate mass flow *</li> <li>■ Energy flow *</li> <li>■ Heat flow difference *</li> </ul>	Define the totalizer behavior in the event of a device alarm.	<ul style="list-style-type: none"> <li>■ Stop</li> <li>■ Actual value</li> <li>■ Last valid value</li> </ul>	Actual value

\* Visibility depends on order options or device settings

## 10.6.6 Carrying out additional display configurations

In the **Display** submenu you can set all the parameters associated with the configuration of the local display.

### Navigation

"Setup" menu → Advanced setup → Display

► Display

- Format display
- Value 1 display
- 0% bargraph value 1
- 100% bargraph value 1
- Decimal places 1
- Value 2 display
- Decimal places 2
- Value 3 display
- 0% bargraph value 3
- 100% bargraph value 3
- Decimal places 3
- Value 4 display
- Decimal places 4
- Language
- Display interval
- Display damping
- Header
- Header text
- Separator
- Backlight

## Parameter overview with brief description

Parameter	Prerequisite	Description	Selection / User entry	Factory setting
Format display	A local display is provided.	Select how measured values are shown on the display.	<ul style="list-style-type: none"> <li>■ 1 value, max. size</li> <li>■ 1 bargraph + 1 value</li> <li>■ 2 values</li> <li>■ 1 value large + 2 values</li> <li>■ 4 values</li> </ul>	1 value, max. size
Value 1 display	A local display is provided.	Select the measured value that is shown on the local display.	<ul style="list-style-type: none"> <li>■ Volume flow</li> <li>■ Corrected volume flow</li> <li>■ Mass flow</li> <li>■ Flow velocity</li> <li>■ Temperature</li> <li>■ Calculated saturated steam pressure *</li> <li>■ Steam quality *</li> <li>■ Total mass flow *</li> <li>■ Condensate mass flow *</li> <li>■ Energy flow *</li> <li>■ Heat flow difference *</li> <li>■ Reynolds number *</li> <li>■ Density *</li> <li>■ Pressure *</li> <li>■ Specific volume *</li> <li>■ Degrees of superheat *</li> <li>■ Totalizer 1</li> <li>■ Totalizer 2</li> <li>■ Totalizer 3</li> </ul>	Volume flow
0% bargraph value 1	A local display is provided.	Enter 0% value for bar graph display.	Signed floating-point number	Country-specific: <ul style="list-style-type: none"> <li>■ 0 m<sup>3</sup>/h</li> <li>■ 0 ft<sup>3</sup>/h</li> </ul>
100% bargraph value 1	A local display is provided.	Enter 100% value for bar graph display.	Signed floating-point number	Depends on country and nominal diameter
Decimal places 1	A measured value is specified in the <b>Value 1 display</b> parameter.	Select the number of decimal places for the display value.	<ul style="list-style-type: none"> <li>■ x</li> <li>■ x.x</li> <li>■ x.xx</li> <li>■ x.xxx</li> <li>■ x.xxxx</li> </ul>	x.xx
Value 2 display	A local display is provided.	Select the measured value that is shown on the local display.	Picklist, see <b>Value 1 display</b> parameter	None
Decimal places 2	A measured value is specified in the <b>Value 2 display</b> parameter.	Select the number of decimal places for the display value.	<ul style="list-style-type: none"> <li>■ x</li> <li>■ x.x</li> <li>■ x.xx</li> <li>■ x.xxx</li> <li>■ x.xxxx</li> </ul>	x.xx
Value 3 display	A local display is provided.	Select the measured value that is shown on the local display.	Picklist, see <b>Value 1 display</b> parameter	None
0% bargraph value 3	A selection has been made in the <b>Value 3 display</b> parameter.	Enter 0% value for bar graph display.	Signed floating-point number	Country-specific: <ul style="list-style-type: none"> <li>■ 0 m<sup>3</sup>/h</li> <li>■ 0 ft<sup>3</sup>/h</li> </ul>
100% bargraph value 3	An option has been selected in the <b>Value 3 display</b> parameter.	Enter 100% value for bar graph display.	Signed floating-point number	0

Parameter	Prerequisite	Description	Selection / User entry	Factory setting
Decimal places 3	A measured value is specified in the <b>Value 3 display</b> parameter.	Select the number of decimal places for the display value.	<ul style="list-style-type: none"> <li>▪ x</li> <li>▪ x.x</li> <li>▪ x.xx</li> <li>▪ x.xxx</li> <li>▪ x.xxxx</li> </ul>	x.xx
Value 4 display	A local display is provided.	Select the measured value that is shown on the local display.	Picklist, see <b>Value 1 display</b> parameter	None
Decimal places 4	A measured value is specified in the <b>Value 4 display</b> parameter.	Select the number of decimal places for the display value.	<ul style="list-style-type: none"> <li>▪ x</li> <li>▪ x.x</li> <li>▪ x.xx</li> <li>▪ x.xxx</li> <li>▪ x.xxxx</li> </ul>	x.xx
Language	A local display is provided.	Set display language.	<ul style="list-style-type: none"> <li>▪ English</li> <li>▪ Deutsch *</li> <li>▪ Français *</li> <li>▪ Español *</li> <li>▪ Italiano *</li> <li>▪ Nederlands *</li> <li>▪ Portuguesa *</li> <li>▪ Polski *</li> <li>▪ русский язык (Russian) *</li> <li>▪ Svenska *</li> <li>▪ Türkçe *</li> <li>▪ 中文 (Chinese) *</li> <li>▪ 日本語 (Japanese) *</li> <li>▪ 한국어 (Korean) *</li> <li>▪ Bahasa Indonesia *</li> <li>▪ tiếng Việt (Vietnamese) *</li> <li>▪ čeština (Czech) *</li> </ul>	English (alternatively, the ordered language is preset in the device)
Display interval	A local display is provided.	Set time measured values are shown on display if display alternates between values.	1 to 10 s	5 s
Display damping	A local display is provided.	Set display reaction time to fluctuations in the measured value.	0.0 to 999.9 s	5.0 s
Header	A local display is provided.	Select header contents on local display.	<ul style="list-style-type: none"> <li>▪ Device tag</li> <li>▪ Free text</li> </ul>	Device tag
Header text	The <b>Free text</b> option is selected in the <b>Header</b> parameter.	Enter display header text.	Max. 12 characters such as letters, numbers or special characters (e.g. @, %, /)	-----
Separator	A local display is provided.	Select decimal separator for displaying numerical values.	<ul style="list-style-type: none"> <li>▪ . (point)</li> <li>▪ , (comma)</li> </ul>	. (point)
Backlight	–	Switch the local display backlight on and off.   Only for device version with local display SD03 (touch control)	<ul style="list-style-type: none"> <li>▪ Disable</li> <li>▪ Enable</li> </ul>	Disable

\* Visibility depends on order options or device settings

## 10.7 Configuration management

After commissioning, you can save the current device configuration, copy it to another measuring point or restore the previous device configuration.



You can do so using the **Configuration management** parameter and the related options found in the **Configuration backup display** submenu.

**Navigation**

"Setup" menu → Advanced setup → Configuration backup display

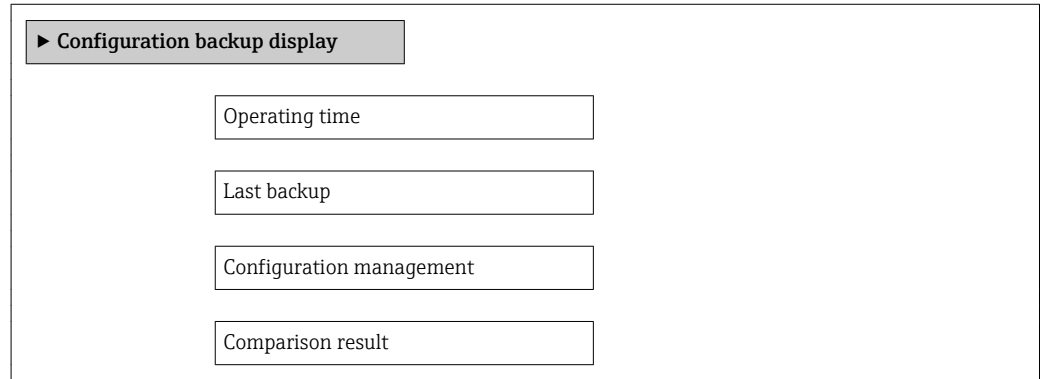

**Parameter overview with brief description**

Parameter	Prerequisite	Description	User interface / Selection	Factory setting
Operating time	–	Indicates how long the device has been in operation.	Days (d), hours (h), minutes (m) and seconds (s)	–
Last backup	A local display is provided.	Indicates when the last data backup was saved to the display module.	Days (d), hours (h), minutes (m) and seconds (s)	–
Configuration management	A local display is provided.	Select action for managing the device data in the display module.	<ul style="list-style-type: none"> <li>▪ Cancel</li> <li>▪ Execute backup</li> <li>▪ Restore</li> <li>▪ Duplicate</li> <li>▪ Compare</li> <li>▪ Clear backup data</li> </ul>	Cancel
Comparison result	A local display is provided.	Comparison between present device data and display backup.	<ul style="list-style-type: none"> <li>▪ Settings identical</li> <li>▪ Settings not identical</li> <li>▪ No backup available</li> <li>▪ Backup settings corrupt</li> <li>▪ Check not done</li> <li>▪ Dataset incompatible</li> </ul>	Check not done

**10.7.1 Function scope of the "Configuration management" parameter**

Options	Description
Execute backup	The current device configuration is backed up from the integrated HistoROM to the device's display module. The backup copy includes the transmitter data of the device.
Restore	The last backup copy of the device configuration is restored from the display module to the device's integrated HistoROM. The backup copy includes the transmitter data of the device.
Duplicate	The transmitter configuration from another device is duplicated to the device using the display module.

Options	Description
Compare	The device configuration saved in the display module is compared with the current device configuration of the integrated HistoROM.
Clear backup data	The backup copy of the device configuration is deleted from the display module of the device.

### *Integrated HistoROM*

A HistoROM is a "non-volatile" device memory in the form of an EEPROM.

 While this action is in progress, the configuration cannot be edited via the local display and a message on the processing status appears on the display.

## 10.8 Simulation

The **Simulation** submenu enables you to simulate, without a real flow situation, various process variables in the process and the device alarm mode and to verify downstream signal chains (switching valves or closed-control loops).

### Navigation

"Diagnostics" menu → Simulation

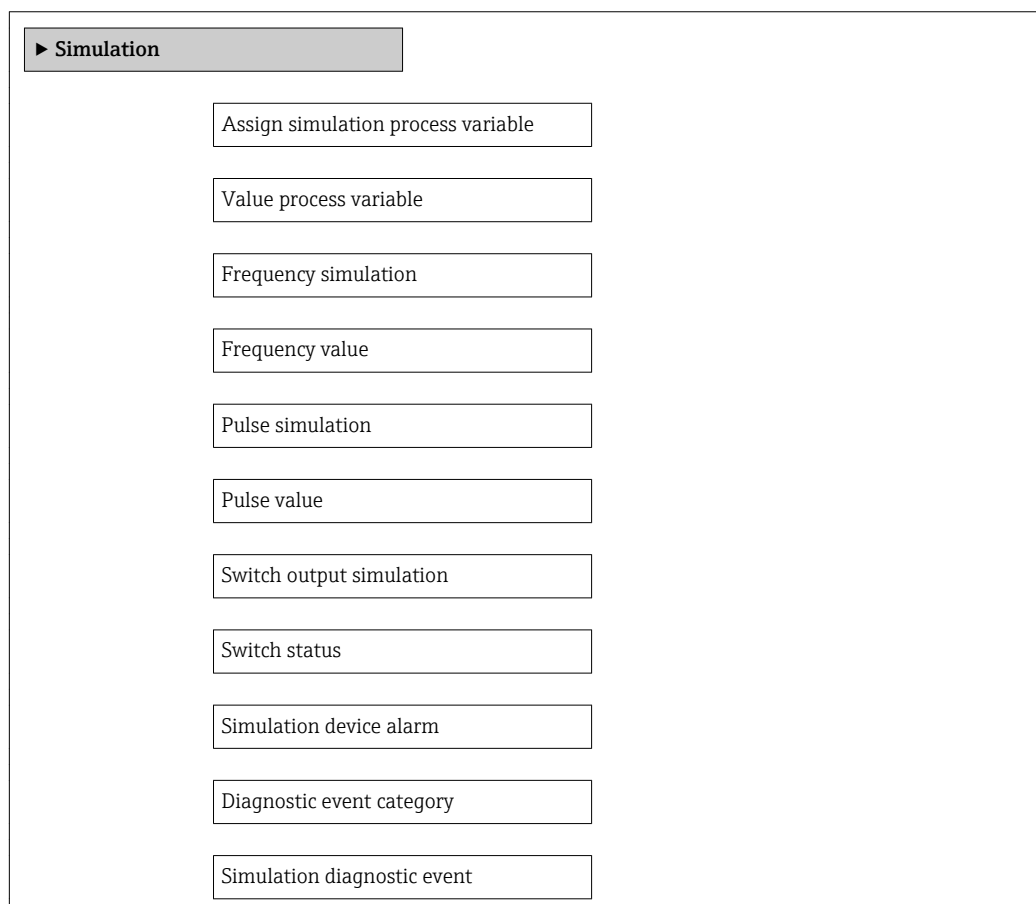

## Parameter overview with brief description

Parameter	Prerequisite	Description	Selection / User entry	Factory setting
Assign simulation process variable	–	Select a process variable for the simulation process that is activated.	<ul style="list-style-type: none"> <li>■ Off</li> <li>■ Volume flow</li> <li>■ Corrected volume flow</li> <li>■ Mass flow</li> <li>■ Flow velocity</li> <li>■ Temperature</li> <li>■ Calculated saturated steam pressure<sup>*</sup></li> <li>■ Steam quality<sup>*</sup></li> <li>■ Total mass flow<sup>*</sup></li> <li>■ Condensate mass flow<sup>*</sup></li> <li>■ Energy flow</li> <li>■ Heat flow difference<sup>*</sup></li> <li>■ Reynolds number</li> </ul>	Off
Value process variable	One of the following options is selected in the <b>Assign simulation process variable</b> parameter (→ 123): <ul style="list-style-type: none"> <li>■ Volume flow</li> <li>■ Corrected volume flow</li> <li>■ Mass flow</li> <li>■ Flow velocity<sup>*</sup></li> <li>■ Temperature<sup>*</sup></li> <li>■ Calculated saturated steam pressure<sup>*</sup></li> <li>■ Steam quality<sup>*</sup></li> <li>■ Total mass flow<sup>*</sup></li> <li>■ Condensate mass flow<sup>*</sup></li> <li>■ Energy flow<sup>*</sup></li> <li>■ Heat flow difference<sup>*</sup></li> <li>■ Reynolds number<sup>*</sup></li> </ul>	Enter the simulation value for the selected process variable.	Depends on the process variable selected	0
Frequency simulation	The <b>Frequency</b> option is selected in the <b>Operating mode</b> parameter.	Switch the simulation of the frequency output on and off.	<ul style="list-style-type: none"> <li>■ Off</li> <li>■ On</li> </ul>	Off
Frequency value	The <b>On</b> option is selected in the <b>Frequency simulation</b> parameter.	Enter the frequency value for the simulation.	0.0 to 1250.0 Hz	0.0 Hz
Pulse simulation	The <b>Pulse</b> option is selected in the <b>Operating mode</b> parameter.	Set and switch off the pulse output simulation.  For <b>Fixed value</b> option: <b>Pulse width</b> parameter (→ 106) defines the pulse width of the pulses output.	<ul style="list-style-type: none"> <li>■ Off</li> <li>■ Fixed value</li> <li>■ Down-counting value</li> </ul>	Off
Pulse value	In the <b>Pulse simulation</b> parameter (→ 123), the <b>Down-counting value</b> option is selected.	Enter the number of pulses for simulation.	0 to 65535	0
Switch output simulation	The <b>Switch</b> option is selected in the <b>Operating mode</b> parameter.	Switch the simulation of the switch output on and off.	<ul style="list-style-type: none"> <li>■ Off</li> <li>■ On</li> </ul>	Off
Switch status	The <b>On</b> option is selected in the <b>Switch output simulation</b> parameter (→ 123).	Select the status of the status output for the simulation.	<ul style="list-style-type: none"> <li>■ Open</li> <li>■ Closed</li> </ul>	Open
Simulation device alarm	–	Switch the device alarm on and off.	<ul style="list-style-type: none"> <li>■ Off</li> <li>■ On</li> </ul>	Off

Parameter	Prerequisite	Description	Selection / User entry	Factory setting
Diagnostic event category	–	Select a diagnostic event category.	<ul style="list-style-type: none"> <li>▪ Sensor</li> <li>▪ Electronics</li> <li>▪ Configuration</li> <li>▪ Process</li> </ul>	Process
Simulation diagnostic event	–	Select a diagnostic event for the simulation process that is activated.	<ul style="list-style-type: none"> <li>▪ Off</li> <li>▪ Diagnostic event picklist (depends on the category selected)</li> </ul>	Off

\* Visibility depends on order options or device settings

## 10.9 Protecting settings from unauthorized access

The following options exist for protecting the configuration of the measuring device from unintentional modification after commissioning:

- Write protection via access code
- Write protection via write protection switch
- Write protection via keypad lock →  58

### 10.9.1 Write protection via access code

With the customer-specific access code, the parameters for the measuring device configuration are write-protected and their values can no longer be changed via local operation.

#### Navigation



"Setup" menu → Advanced setup → Administration → Define access code

▶ Define access code

#### Defining the access code via local display

1. Navigate to the **Enter access code** parameter.
2. Define a max. 4-digit numeric code as an access code.
3. Enter the access code again to confirm the code.
  - ↳ The -symbol appears in front of all write-protected parameters.

The device automatically locks the write-protected parameters again if a key is not pressed for 10 minutes in the navigation and editing view. The device locks the write-protected parameters automatically after 60 s if the user skips back to the operational display mode from the navigation and editing view.

-  If write access is activated via access code, it can be also be deactivated only via the access code →  58.
- The user role with which the user is currently logged on via the local display →  58 is indicated by the **Access status display** parameter. Navigation path: "Operation" menu → Access status display

### Parameters which can always be modified via the local display

Certain parameters that do not affect the measurement are excepted from write protection via the local display. Despite the defined access code, these parameters can always be modified even if the other parameters are locked.

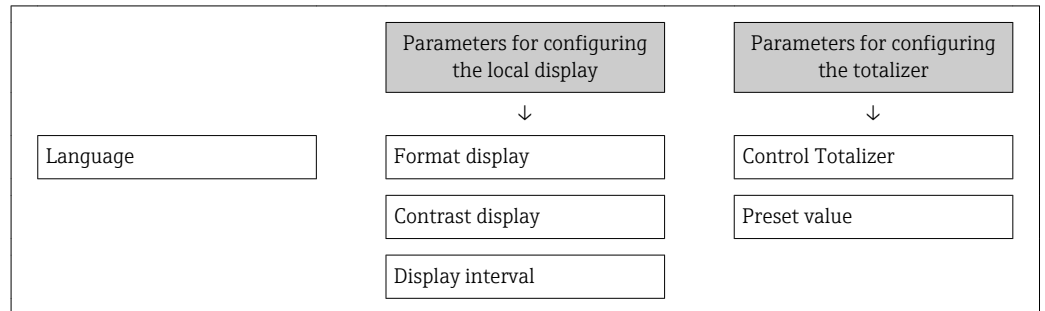

### 10.9.2 Write protection via write protection switch

Unlike write protection via a user-specific access code, this allows write access to the entire operating menu - other than the **"Contrast display" parameter** - to be locked.

The parameter values are now read only and cannot be edited any more (exception **"Contrast display" parameter**):

- Via local display
- Via PROFIBUS PA protocol

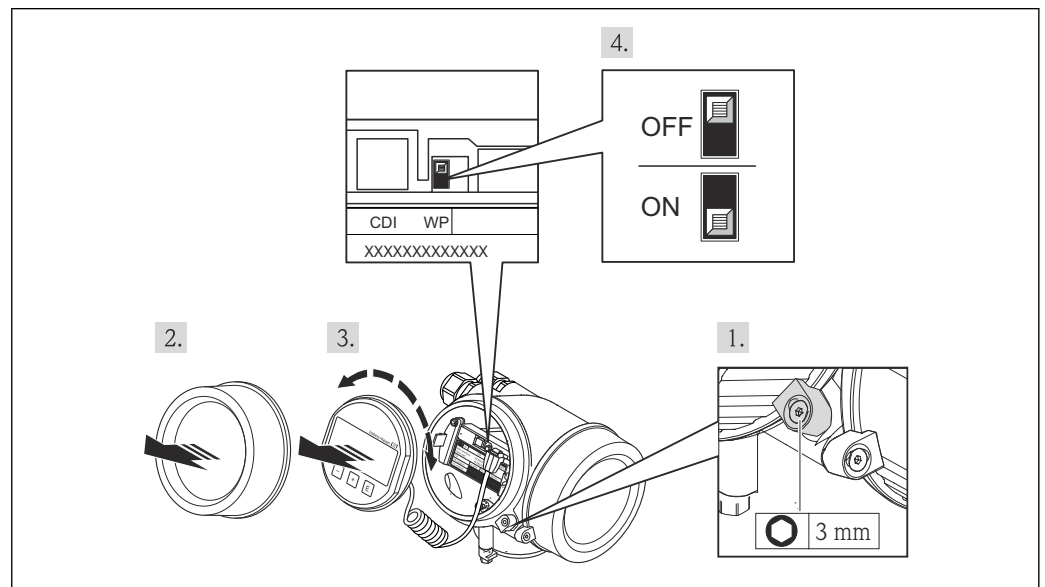

1. Loosen the securing clamp.
2. Unscrew the electronics compartment cover.

3. Pull out the display module with a gentle rotational movement. To make it easier to access the write protection switch, attach the display module to the edge of the electronics compartment.
  - ↳ Display module is attached to the edge of the electronics compartment.

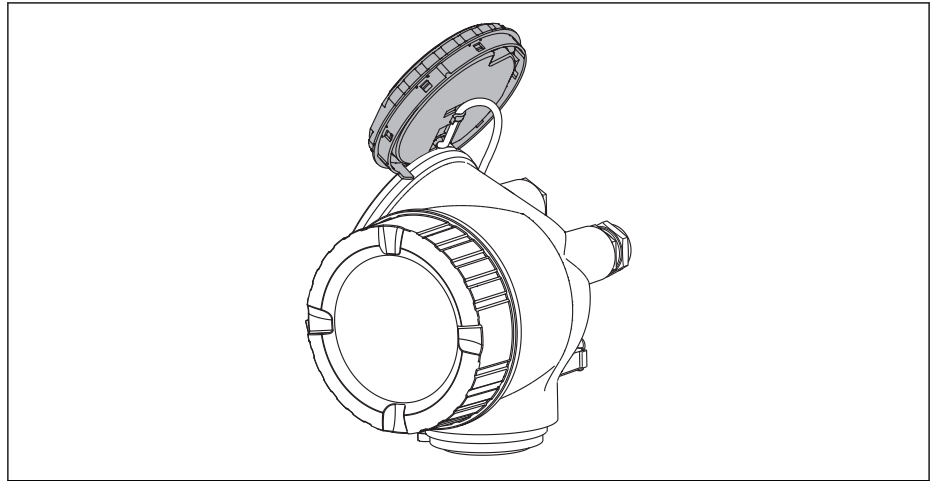

A0013909

4. Setting the write protection switch (WP) on the main electronics module to the **ON** position enables hardware write protection. Setting the write protection switch (WP) on the main electronics module to the **OFF** position (factory setting) disables hardware write protection.
  - ↳ If hardware write protection is enabled, the **Locking status** parameter displays the **Hardware locked** option . In addition, on the local display the -symbol appears in front of the parameters in the header of the operational display and in the navigation view.

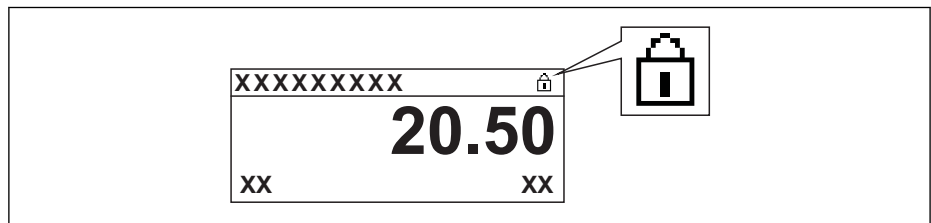

A0015870

If hardware write protection is disabled, no option is displayed in the **Locking status** parameter . On the local display, the -symbol disappears from in front of the parameters in the header of the operational display and in the navigation view.

5. Feed the cable into the gap between the housing and main electronics module and plug the display module into the electronics compartment in the desired direction until it engages.
6. Reverse the removal procedure to reassemble the transmitter.

# 11 Operation

## 11.1 Reading the device locking status

Device active write protection: **Locking status** parameter

### Navigation



"Operation" menu → Locking status

*Function scope of the "Locking status" parameter*



Options	Description
None	The access status displayed in " <b>Access status display</b> " parameter applies →  58. Only appears on local display.
Hardware locked	The DIP switch for hardware locking is activated on the main electronics module. This prevents write access to the parameters .
Temporarily locked	Write access to the parameters is temporarily lock due to device-internal processing (e.g. data upload/download, reset). Once the internal processing has been completed, the parameters can be changed once again.

## 11.2 Adjusting the operating language

Information →  72

 For information on the operating languages supported by the measuring device →  206

## 11.3 Configuring the display

- Basic settings for the local display →  82
- Advanced settings for the local display →  118

## 11.4 Reading measured values

With the **Measured values** submenu, it is possible to read all the measured values.

### 11.4.1 Process variables

The **Process variables** submenu contains all the parameters needed to display the current measured values for every process variable.

### Navigation

"Diagnostics" menu → Measured values → Process variables

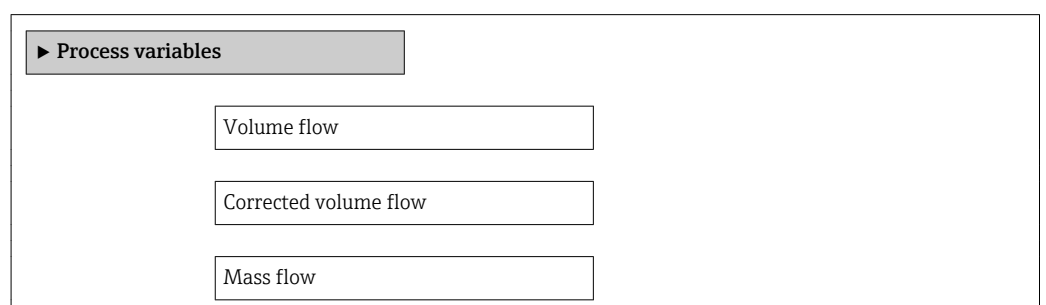

Flow velocity
Temperature
Calculated saturated steam pressure
Steam quality
Total mass flow
Condensate mass flow
Energy flow
Heat flow difference
Reynolds number
Density
Specific volume
Pressure
Compressibility factor
Degrees of superheat

**Parameter overview with brief description**

Parameter	Prerequisite	Description	User interface
Volume flow	-	Displays the volume flow currently measured. <i>Dependency</i> The unit is taken from the <b>Volume flow unit</b> parameter	Signed floating-point number
Corrected volume flow	-	Displays the corrected volume flow currently calculated. <i>Dependency</i> The unit is taken from: <b>Corrected volume flow unit</b> parameter	Signed floating-point number
Mass flow	-	Displays the mass flow currently calculated. <i>Dependency</i> The unit is taken from the <b>Mass flow unit</b> parameter	Signed floating-point number
Flow velocity	-	Displays the flow velocity currently calculated. <i>Dependency</i> The unit is taken from the <b>Velocity unit</b> parameter	Signed floating-point number



Parameter	Prerequisite	Description	User interface
Temperature	–	Displays the temperature currently measured. <i>Dependency</i> The unit is taken from the <b>Temperature unit</b> parameter	Signed floating-point number
Calculated saturated steam pressure	The following conditions are met: <ul style="list-style-type: none"> <li>Order code for "Sensor version", option "Mass flow"</li> <li>The <b>Steam</b> option is selected in the <b>Select medium</b> parameter.</li> </ul>	Displays the saturated steam pressure currently calculated. <i>Dependency</i> The unit is taken from the <b>Pressure unit</b> parameter	Signed floating-point number
Steam quality	The following conditions are met: <ul style="list-style-type: none"> <li>Order code for "Sensor version", option "Mass flow"</li> <li>The <b>Steam</b> option is selected in the <b>Select medium</b> parameter.</li> </ul>	Displays the current steam quality. Depends on the compensation mode of the steam quality (Steam quality parameter (7605)).	Signed floating-point number
Total mass flow	The following conditions are met: <ul style="list-style-type: none"> <li>Order code for "Application package", option EU "Wet steam measurement"</li> <li>The <b>Steam</b> option is selected in the <b>Select medium</b> parameter.</li> </ul>	Displays the total mass flow currently calculated (steam and condensate). <i>Dependency</i> The unit is taken from the <b>Mass flow unit</b> parameter	Signed floating-point number
Condensate mass flow	The following conditions are met: <ul style="list-style-type: none"> <li>Order code for "Application package", option EU "Wet steam measurement"</li> <li>The <b>Steam</b> option is selected in the <b>Select medium</b> parameter.</li> </ul>	Displays the condensate mass flow currently calculated. <i>Dependency</i> The unit is taken from the <b>Mass flow unit</b> parameter	Signed floating-point number
Energy flow	For the following order code: "Sensor version", option "Mass flow"	Displays the energy flow currently calculated. <i>Dependency</i> The unit is taken from the <b>Energy flow unit</b> parameter	Signed floating-point number
Heat flow difference	The following conditions are met: Order code for "Sensor version", option "Mass flow"  In the <b>Select gas type</b> parameter, one of the following options is selected: <ul style="list-style-type: none"> <li>Single gas</li> <li>Gas mixture</li> <li>Natural gas</li> <li>User-specific gas</li> </ul>	Displays the heat flow difference currently calculated. <i>Dependency</i> The unit is taken from the <b>Energy flow unit</b> parameter	Signed floating-point number
Reynolds number	For the following order code: "Sensor version", option "Mass flow"	Displays the Reynolds number currently calculated.	Signed floating-point number
Density	For the following order code: "Sensor version", option "Mass flow"	Displays the density currently measured. <i>Dependency</i> The unit is taken from the <b>Density unit</b> parameter	Positive floating-point number
Specific volume	For the following order code: "Sensor version", option "Mass flow"	Displays the current value for the specific volume. <i>Dependency</i> The unit is taken from the <b>Specific volume unit</b> parameter	Positive floating-point number
Pressure	For the following order code: <ul style="list-style-type: none"> <li>"Sensor version", option "Mass flow"</li> <li>In the <b>External value</b> parameter, the <b>Pressure</b> option is selected.</li> </ul>	Displays the current process pressure. <i>Dependency</i> The unit is taken from the <b>Pressure unit</b> parameter	0 to 250 bar

Parameter	Prerequisite	Description	User interface
Compressibility factor	The following conditions are met: Order code for "Sensor version", option "Mass flow"  In the <b>Select medium</b> parameter, the <b>Gas</b> option or <b>Steam</b> option is selected.	Displays the compressibility factor currently calculated.	0 to 2
Degrees of superheat	In the <b>Select medium</b> parameter, the <b>Steam</b> option is selected.	Displays the degree of superheating currently calculated.	0 to 500 K

### 11.4.2 Totalizer

The **Totalizer** submenu contains all the parameters needed to display the current measured values for every totalizer.

#### Navigation

"Diagnostics" menu → Measured values → Totalizer 1 to 3

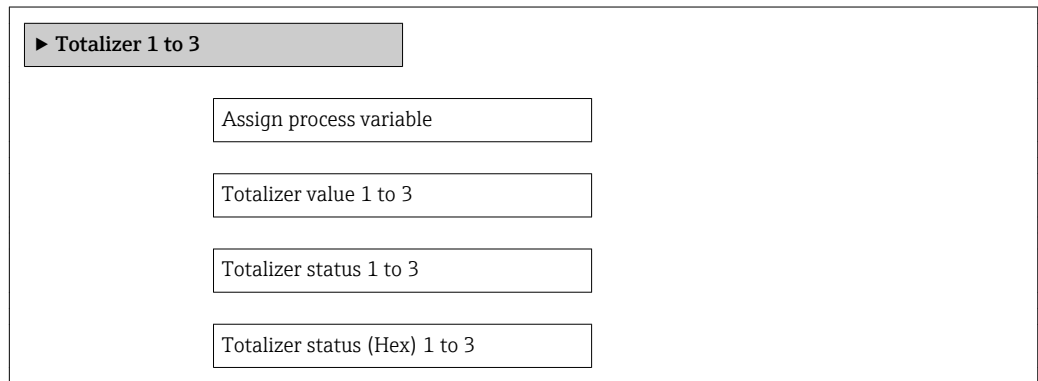

#### Parameter overview with brief description

Parameter	Prerequisite	Description	Selection / User entry / User interface	Factory setting
Assign process variable	–	Select process variable for totalizer.	<ul style="list-style-type: none"> <li>▪ Volume flow</li> <li>▪ Mass flow</li> <li>▪ Corrected volume flow</li> <li>▪ Total mass flow *</li> <li>▪ Condensate mass flow *</li> <li>▪ Energy flow *</li> <li>▪ Heat flow difference *</li> </ul>	<ul style="list-style-type: none"> <li>▪ Totalizer 1: Volume flow</li> <li>▪ Totalizer 2: Mass flow</li> <li>▪ Totalizer 3: Corrected volume flow</li> </ul>
Totalizer value 1 to 3	In the <b>Assign process variable</b> parameter one of the following options is selected: <ul style="list-style-type: none"> <li>▪ Volume flow</li> <li>▪ Mass flow</li> <li>▪ Corrected volume flow</li> <li>▪ Total mass flow</li> <li>▪ Condensate mass flow</li> <li>▪ Energy flow</li> <li>▪ Heat flow difference</li> </ul>	Displays the current totalizer counter value.	Signed floating-point number	0 m <sup>3</sup>

Parameter	Prerequisite	Description	Selection / User entry / User interface	Factory setting
Totalizer status 1 to 3	–	Displays the current totalizer status.	<ul style="list-style-type: none"> <li>■ Good</li> <li>■ Uncertain</li> <li>■ Bad</li> </ul>	–
Totalizer status (Hex) 1 to 3	In <b>Target mode</b> parameter, the <b>Auto</b> option is selected.	Displays the current status value (hex) of the totalizer.	0 to 0xFF	–

\* Visibility depends on order options or device settings

### 11.4.3 Output values

The **Output values** submenu contains all the parameters needed to display the current measured values for every output.

#### Navigation

"Diagnostics" menu → Measured values → Output values

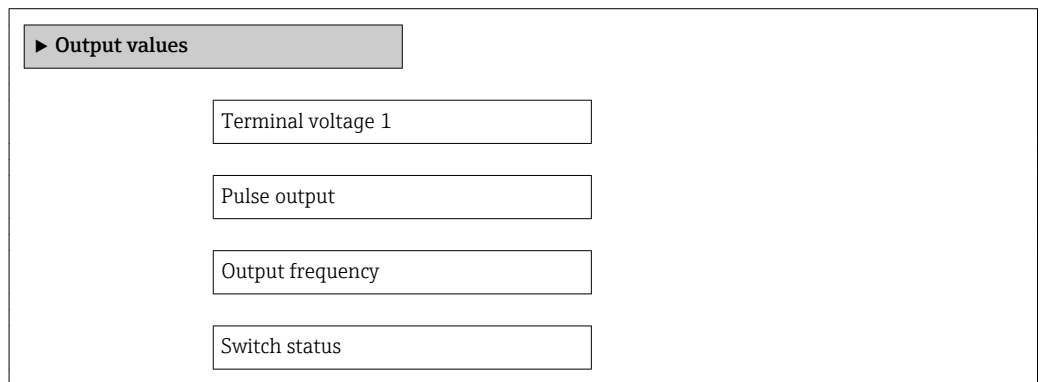

#### Parameter overview with brief description

Parameter	Prerequisite	Description	User interface
Terminal voltage 1	–	Displays the current terminal voltage that is applied at the current output.	0.0 to 50.0 V
Pulse output	The <b>Pulse</b> option is selected in the <b>Operating mode</b> parameter.	Displays the pulse frequency currently output.	Positive floating-point number
Output frequency	In the <b>Operating mode</b> parameter, the <b>Frequency</b> option is selected.	Displays the value currently measured for the frequency output.	0 to 1250 Hz
Switch status	In the <b>Operating mode</b> parameter, the <b>Switch</b> option is selected.	Displays the current switch output status.	<ul style="list-style-type: none"> <li>■ Open</li> <li>■ Closed</li> </ul>

## 11.5 Adapting the measuring device to the process conditions

The following are available for this purpose:

- Basic settings using the **Setup** menu → 74
- Advanced settings using the **Advanced setup** submenu → 86

## 11.6 Performing a totalizer reset

In the **Operation** submenu the totalizers are reset:  
Control Totalizer

Function scope of the "Control Totalizer " parameter

Options	Description
Totalize	The totalizer is started.
Reset + hold	The totaling process is stopped and the totalizer is reset to 0.
Preset + hold	The totaling process is stopped and the totalizer is set to its defined start value from the <b>Preset value 1 to 3</b> parameter.
Stop totalizing option	Totalizing is stopped.

**Navigation**

"Operation" menu → Operation

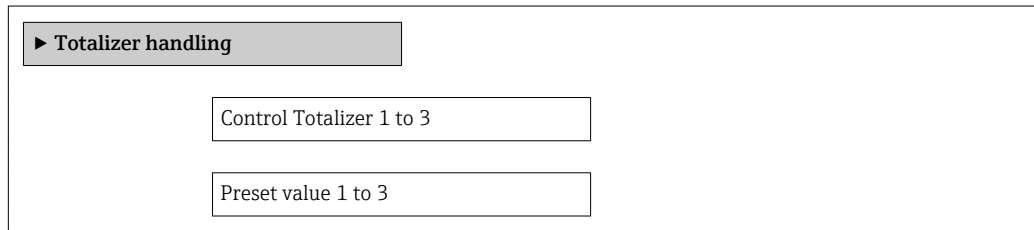



**Parameter overview with brief description**

Parameter	Prerequisite	Description	Selection / User entry	Factory setting
Control Totalizer	In the <b>Assign process variable</b> parameter, one of the following options is selected: <ul style="list-style-type: none"> <li>■ Volume flow</li> <li>■ Mass flow</li> <li>■ Corrected volume flow</li> <li>■ Total mass flow *</li> <li>■ Condensate mass flow *</li> <li>■ Energy flow *</li> <li>■ Heat flow difference *</li> </ul>	Control totalizer value.	<ul style="list-style-type: none"> <li>■ Totalize</li> <li>■ Reset + hold</li> <li>■ Preset + hold</li> </ul>	Totalize
Preset value	In the <b>Assign process variable</b> parameter one of the following options is selected: <ul style="list-style-type: none"> <li>■ Volume flow</li> <li>■ Mass flow</li> <li>■ Corrected volume flow</li> <li>■ Total mass flow</li> <li>■ Condensate mass flow</li> <li>■ Energy flow</li> <li>■ Heat flow difference</li> </ul>	Specify start value for totalizer.	Signed floating-point number	0 m <sup>3</sup>
Reset all totalizers	-	Reset all totalizers to 0 and start.	<ul style="list-style-type: none"> <li>■ Cancel</li> <li>■ Reset + totalize</li> </ul>	Cancel

\* Visibility depends on order options or device settings

## 11.7 Showing data logging

The **Extended HistoROM** application package must be enabled in the device (order option) for the **Data logging** submenu to appear. This contains all the parameters for the measured value history.

 The measured value history is also available via the FieldCare plant asset management tool →  61.

**Function scope**

- A total of 1000 measured values can be stored
- 4 logging channels
- Adjustable logging interval for data logging
- Display of the measured value trend for each logging channel in the form of a chart

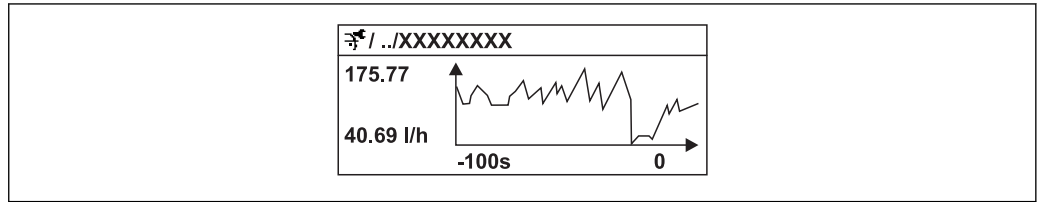

A0016222

30 Chart of a measured value trend

- x-axis: depending on the number of channels selected displays 250 to 1000 measured values of a process variable.
- y-axis: displays the approximate measured value span and constantly adapts this to the ongoing measurement.

**i** If the length of the logging interval or the assignment of the process variables to the channels is changed, the content of the data logging is deleted.

**Navigation**

"Diagnostics" menu → Data logging

**"Data logging" submenu**

▶ Data logging

Assign channel 1

Assign channel 2

Assign channel 3

Assign channel 4

Logging interval

Clear logging data



▶ Display channel 1

▶ Display channel 2

▶ Display channel 3

▶ Display channel 4

## Parameter overview with brief description

Parameter	Prerequisite	Description	Selection / User entry	Factory setting
Assign channel 1 to 4	<p>The <b>Extended HistoROM</b> application package is available.</p> <p> The software options currently enabled are displayed in the <b>Software option overview</b> parameter.</p>	Assign process variable to logging channel.	<ul style="list-style-type: none"> <li>▪ Off</li> <li>▪ Volume flow</li> <li>▪ Corrected volume flow</li> <li>▪ Mass flow</li> <li>▪ Flow velocity</li> <li>▪ Temperature</li> <li>▪ Calculated saturated steam pressure</li> <li>▪ Steam quality</li> <li>▪ Total mass flow</li> <li>▪ Condensate mass flow</li> <li>▪ Energy flow</li> <li>▪ Heat flow difference</li> <li>▪ Reynolds number</li> <li>▪ Density</li> <li>▪ Pressure</li> <li>▪ Specific volume</li> <li>▪ Degrees of superheat</li> <li>▪ Vortex frequency</li> <li>▪ Electronic temperature</li> </ul>	Off
Logging interval	<p>The <b>Extended HistoROM</b> application package is available.</p> <p> The software options currently enabled are displayed in the <b>Software option overview</b> parameter.</p>	Define the logging interval for data logging. This value defines the time interval between the individual data points in the memory.	1.0 to 3 600.0 s	10.0 s
Clear logging data	<p>The <b>Extended HistoROM</b> application package is available.</p> <p> The software options currently enabled are displayed in the <b>Software option overview</b> parameter.</p>	Clear the entire logging data.	<ul style="list-style-type: none"> <li>▪ Cancel</li> <li>▪ Clear data</li> </ul>	Cancel

## 12 Diagnostics and troubleshooting

### 12.1 General troubleshooting



*For local display*

Problem	Possible causes	Remedy
Local display dark and no output signals	Supply voltage does not match the value indicated on the nameplate.	Apply the correct supply voltage .
Local display dark and no output signals	The polarity of the supply voltage is wrong.	Correct the polarity.
Local display dark and no output signals	No contact between connecting cables and terminals.	Check the connection of the cables and correct if necessary.
Local display dark and no output signals	Terminals are not plugged into the I/O electronics module correctly.	Check terminals.
Local display dark and no output signals	I/O electronics module is defective.	Order spare part → 179.
Local display is dark, but signal output is within the valid range	Display is set too bright or too dark.	<ul style="list-style-type: none"> <li>▪ Set the display brighter by simultaneously pressing  + .</li> <li>▪ Set the display darker by simultaneously pressing  + .</li> </ul>
Local display is dark, but signal output is within the valid range	The cable of the display module is not plugged in correctly.	Insert the plug correctly into the main electronics module and display module.
Local display is dark, but signal output is within the valid range	Display module is defective.	Order spare part → 179.
Backlighting of local display is red	Diagnostic event with "Alarm" diagnostic behavior has occurred.	Take remedial measures → 145
Text on local display appears in a foreign language and cannot be understood.	Incorrect operating language is configured.	<ol style="list-style-type: none"> <li>1. Press  +  for 2 s ("home position").</li> <li>2. Press .</li> <li>3. Set the desired language in the <b>Language</b> parameter.</li> </ol>
Message on local display: "Communication Error" "Check Electronics"	Communication between the display module and the electronics is interrupted.	<ul style="list-style-type: none"> <li>▪ Check the cable and the connector between the main electronics module and display module.</li> <li>▪ Order spare part → 179.</li> </ul>

*For output signals*

Problem	Possible causes	Remedy
Signal output outside the valid range	Main electronics module is defective.	Order spare part → 179.
Device shows correct value on local display, but signal output is incorrect, though in the valid range.	Configuration error	Check and correct the parameter configuration.
Device measures incorrectly.	Configuration error or device is operated outside the application.	<ol style="list-style-type: none"> <li>1. Check and correct parameter configuration.</li> <li>2. Observe limit values specified in the "Technical Data".</li> </ol>

*For access*

Problem	Possible causes	Remedy
No write access to parameters	Hardware write protection enabled	Set the write protection switch on the main electronics module to the OFF position .
No write access to parameters	Current user role has limited access authorization	1. Check user role →  58. 2. Enter correct customer-specific access code →  58.
No connection via service interface	Incorrect configuration of USB interface on PC or driver not installed correctly.	Observe the documentation for the Commubox.  FXA291: Document "Technical Information" TI00405C



## 12.2 Diagnostic information on local display

### 12.2.1 Diagnostic message

Faults detected by the self-monitoring system of the measuring device are displayed as a diagnostic message in alternation with the operational display.

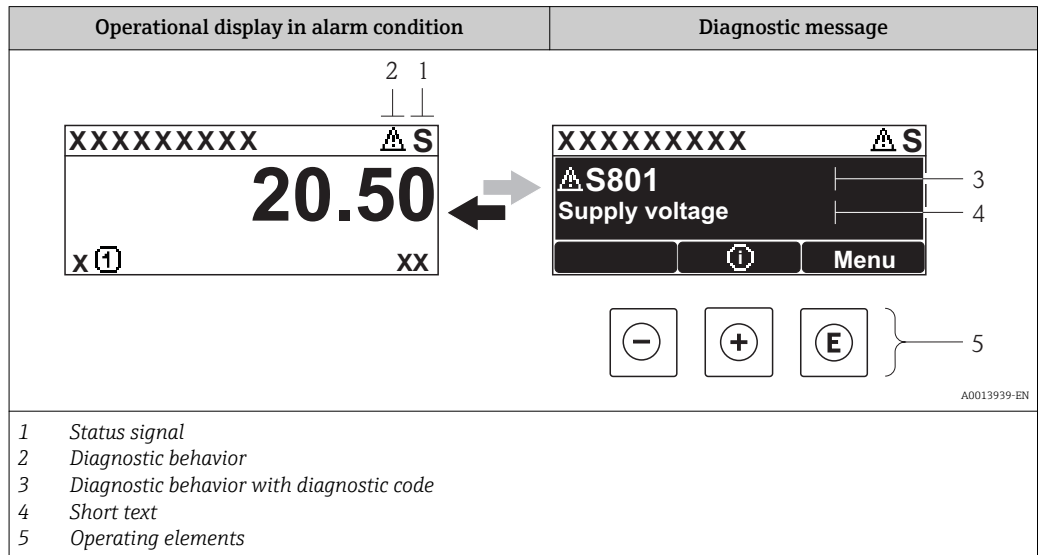

If two or more diagnostic events are pending simultaneously, only the message of the diagnostic event with the highest priority is shown.

- i** Other diagnostic events that have occurred can be called up in the **Diagnostics** menu:
  - Via parameters → 170
  - Via submenus → 171



#### Status signals

The status signals provide information on the state and reliability of the device by categorizing the cause of the diagnostic information (diagnostic event).

- i** The status signals are categorized according to VDI/VDE 2650 and NAMUR Recommendation NE 107: F = Failure, C = Function Check, S = Out of Specification, M = Maintenance Required

Symbol	Meaning
<b>F</b> <small>A0013956</small>	<b>Failure</b> A device error has occurred. The measured value is no longer valid.
<b>C</b> <small>A0013959</small>	<b>Function check</b> The device is in service mode (e.g. during a simulation).
<b>S</b> <small>A0013958</small>	<b>Out of specification</b> The device is operated: Outside its technical specification limits (e.g. outside the process temperature range)
<b>M</b> <small>A0013957</small>	<b>Maintenance required</b> Maintenance is required. The measured value remains valid.

### Diagnostic behavior



Symbol	Meaning
 <small>A0013961</small>	<b>Alarm</b> <ul style="list-style-type: none"> <li>▪ Measurement is interrupted.</li> <li>▪ Signal outputs and totalizers assume the defined alarm condition.</li> <li>▪ A diagnostic message is generated.</li> <li>▪ For local display with touch control: the background lighting changes to red.</li> </ul>
 <small>A0013962</small>	<b>Warning</b> Measurement is resumed. The signal outputs and totalizers are not affected. A diagnostic message is generated.

### Diagnostic information

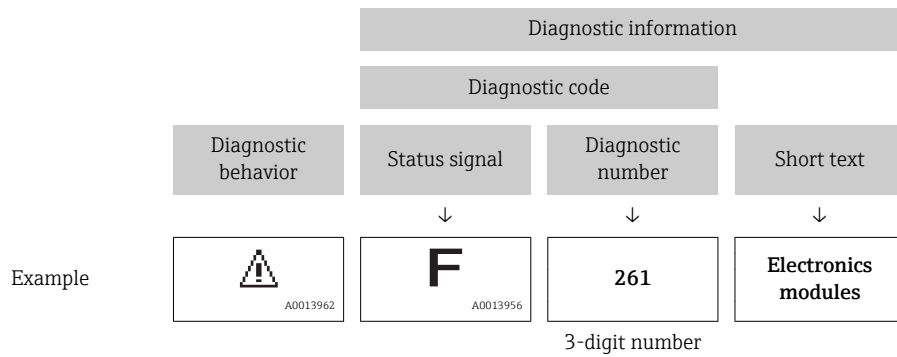
The fault can be identified using the diagnostic information. The short text helps you by providing information about the fault. In addition, the corresponding symbol for the diagnostic behavior is displayed in front of the diagnostic information on the local display.



### Operating elements

Key	Meaning
 <small>A0013970</small>	<b>Plus key</b> <i>In a menu, submenu</i> Opens the message about remedy information.
 <small>A0013952</small>	<b>Enter key</b> <i>In a menu, submenu</i> Opens the operating menu.

## 12.2.2 Calling up remedial measures

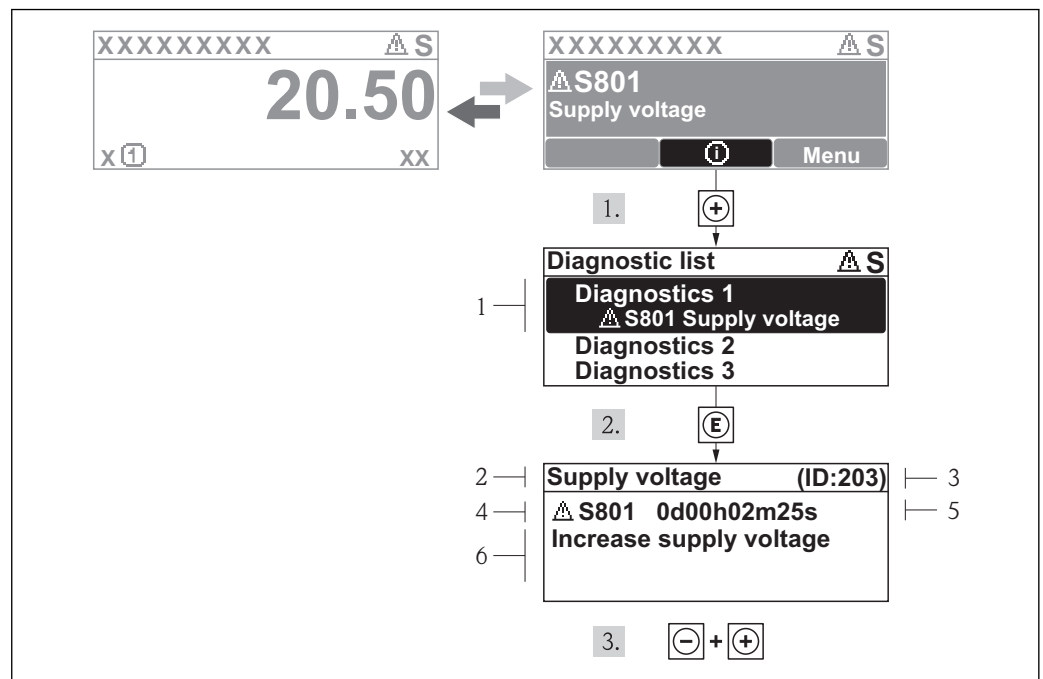

31 Message for remedial measures

- 1 Diagnostic information
- 2 Short text
- 3 Service ID
- 4 Diagnostic behavior with diagnostic code
- 5 Operation time of occurrence
- 6 Remedial measures

The user is in the diagnostic message.

1. Press  $\oplus$  ( $\text{ⓘ}$  symbol).  
↳ The **Diagnostic list** submenu opens.
2. Select the desired diagnostic event with  $\oplus$  or  $\ominus$  and press  $\text{⏎}$ .  
↳ The message for the remedial measures for the selected diagnostic event opens.
3. Press  $\ominus + \oplus$  simultaneously.  
↳ The message for the remedial measures closes.

The user is in the **Diagnostics** menu at an entry for a diagnostics event, e.g. in the **Diagnostic list** submenu or the **Previous diagnostics** parameter.

1. Press  $\text{⏎}$ .  
↳ The message for the remedial measures for the selected diagnostic event opens.
2. Press  $\ominus + \oplus$  simultaneously.  
↳ The message for the remedial measures closes.

## 12.3 Diagnostic information in FieldCare

### 12.3.1 Diagnostic options

Any faults detected by the measuring device are displayed on the home page of the operating tool once the connection has been established.

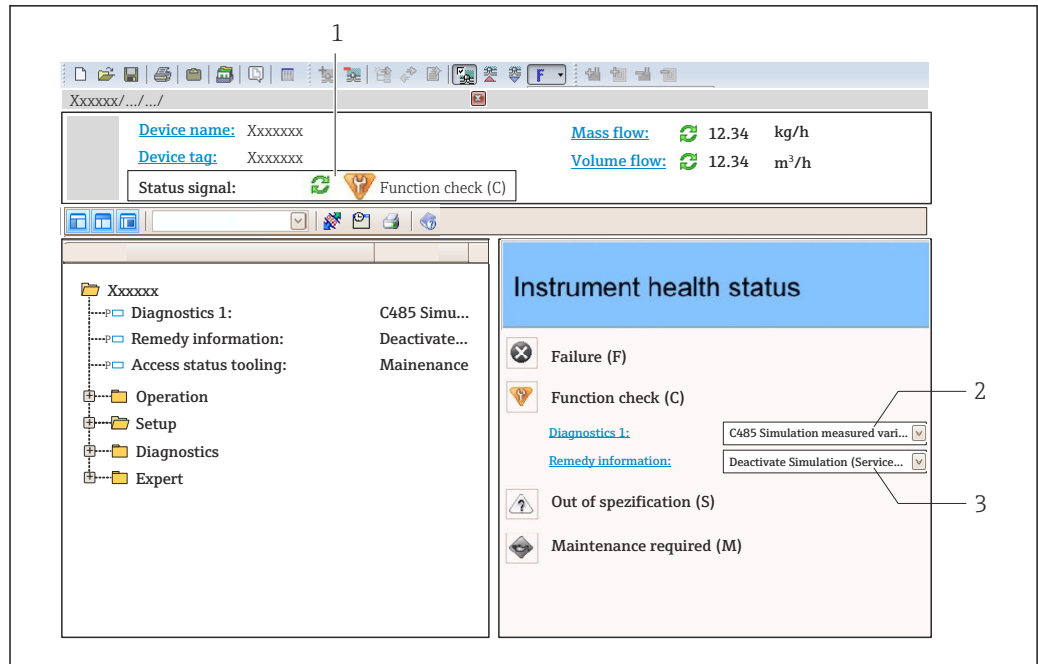

- 1 Status area with status signal → 137
- 2 Diagnostic information → 138
- 3 Remedy information with Service ID

**i** Furthermore, diagnostic events that have occurred can be viewed in the **Diagnostics** menu:

- Via parameter → 170
- Via submenu → 171

### Diagnostic information

The fault can be identified using the diagnostic information. The short text helps you by providing information about the fault. In addition, the corresponding symbol for the diagnostic behavior is displayed in front of the diagnostic information on the local display.

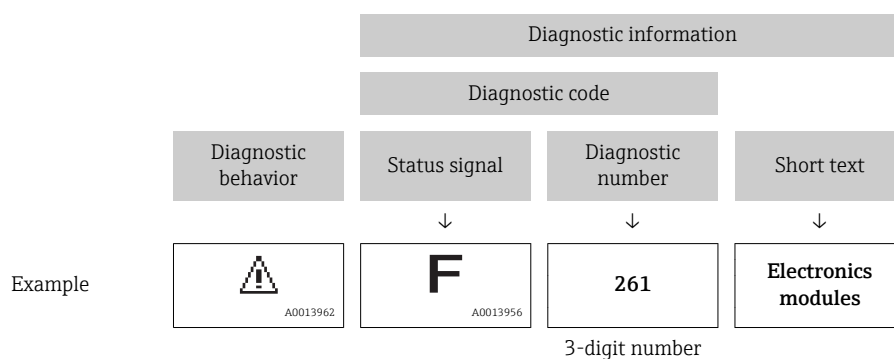

### 12.3.2 Calling up remedy information

Remedy information is provided for every diagnostic event to ensure that problems can be rectified quickly:

- On the home page  
Remedy information is displayed in a separate field below the diagnostics information.
- In the **Diagnostics** menu  
Remedy information can be called up in the working area of the user interface.

The user is in the **Diagnostics** menu.

1. Call up the desired parameter.
2. On the right in the working area, mouse over the parameter.
  - ↳ A tool tip with remedy information for the diagnostic event appears.

## 12.4 Adapting the diagnostic information

### 12.4.1 Adapting the measured value and device status

#### Measured value status

Each diagnostic number is assigned a specific measured value status at the factory. The user can change this assignment for specific diagnostic numbers via the **Var. status xx** parameter.

#### Navigation path

"Expert" menu → System → Diagnostic handling → Condensed status → Assign behavior of measured value status xx

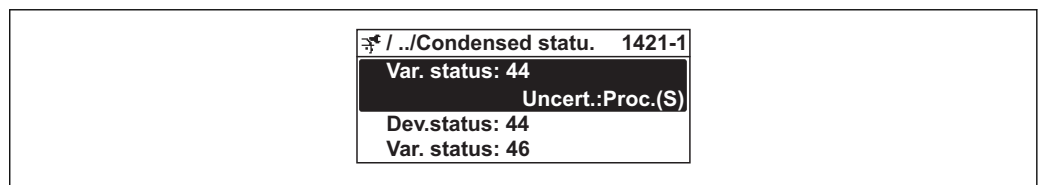

A0019175-EN

Quality	Substatus	Status (hex)	Event category	Event class
GOOD	None	0x80	-	-
GOOD	Maintenance required	0xA4	M	Warning
GOOD	Maintenance demanded	0xA8	M	Warning
GOOD	Function check	0xBC	-	-
BAD	Maintenance alarm	0x24	F	Alarm
BAD	Process related, no maintenance	0x28	F	Alarm
BAD	Function check	0x3C	C	Warning
UNCERTAIN	Maintenance demanded	0x68	M	Warning
UNCERTAIN	Process related, no maintenance	0x78	S	Warning

#### Device status

Each diagnostic number is assigned a specific device status at the factory. The user can change this assignment for specific diagnostic numbers via the **Dev. status xx** parameter.

#### Navigation path

"Expert" menu → System → Diagnostic handling → Condensed status → Assign behavior of device status xx

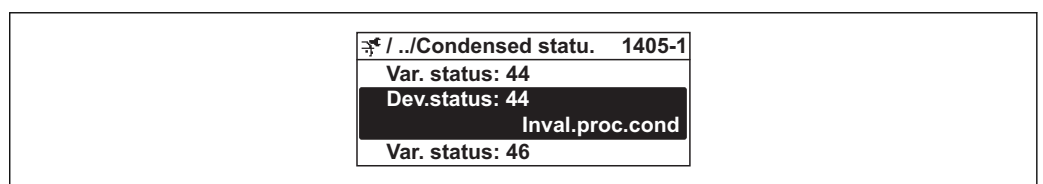

A0019186-EN

Mnemonic	Octet	Bit
Maintenance required	2	5
Maintenance alarm	3	0
Maintenance demanded	3	1
Function check	3	2
Invalid process conditions	3	3

## 12.4.2 Adapting the diagnostic behavior

Each item of diagnostic information is assigned a specific diagnostic behavior at the factory. The user can change this assignment for certain diagnostic information in the **Diagnostic behavior** submenu.

 Diagnostic behavior in accordance with the PROFIBUS PA Profile 3.02 Specification, Condensed Status.

"Expert" menu → System → Diagnostic handling → Diagnostic behavior

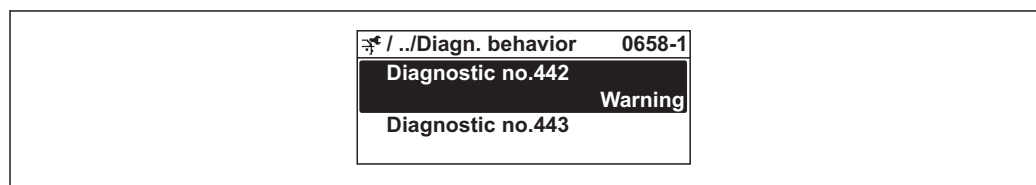

A0019179-EN

### Available diagnostic behaviors

The following diagnostic behaviors can be assigned:

Diagnostic behavior	Description
Alarm	Measurement is interrupted. The totalizers assume the defined alarm condition. A diagnostic message is generated. For local display with touch control: the background lighting changes to red.
Warning	Measurement is resumed. Measured value output via PROFIBUS and totalizers are not affected. A diagnostic message is generated.
Logbook entry only	The device continues to measure. The diagnostic message is entered in the Event logbook (events list) submenu only and is not displayed in alternation with the measured value display.
Off	The diagnostic event is ignored, and no diagnostic message is generated or entered.

### Displaying the measured value status

If the Analog Input, Digital Input and Totalizer function blocks are configured for cyclic data transmission, the device status is coded as per the PROFIBUS PA Profile 3.02 Specification and transmitted along with the measured value to the PROFIBUS Master (Class 1) via the coding byte (byte 5). The coding byte is split into three segments: Quality, Quality Substatus and Limits.

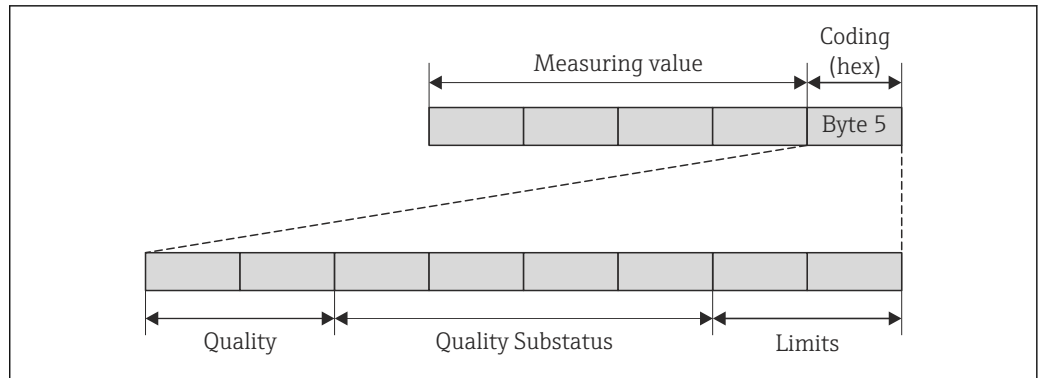

A0021271-EN

32 Structure of the coding byte

The content of the coding byte depends on the configured failsafe mode in the particular function block. Depending on which failsafe mode has been configured, status information in accordance with PROFIBUS Profile Specification 3.02 is transmitted to the PROFIBUS Master (Class 1) via the coding byte.

**Determining the measured value status and device status via the diagnostic behavior**

When the diagnostic behavior is assigned, this also changes the measured value status and device status for the diagnostic information. The measured value status and device status depend on the choice of diagnostic behavior and the group in which the diagnostic information is located. The measured value status and device status are firmly assigned to the particular diagnostic behavior and cannot be changed individually.

The diagnostic information is grouped as follows:

- Diagnostic information pertaining to the sensor: diagnostic number 000 to 199  
→ 143
- Diagnostic information pertaining to the electronics: diagnostic number 200 to 399  
→ 144
- Diagnostic information pertaining to the configuration: diagnostic number 400 to 599  
→ 144
- Diagnostic information pertaining to the process: diagnostic number 800 to 999  
→ 144

Depending on the group in which diagnostic information is located, the following measured value status and device status are firmly assigned to the particular diagnostic behavior:

*Diagnostic information pertaining to the sensor (diagnostic no.: 000 to 199)*

Diagnostic behavior (configurable)	Measured value status (fixed assignment)				Device diagnostics (fixed assignment)
	Quality	Quality Substatus	Coding (hex)	Category (NE107)	
Alarm	BAD	Maintenance alarm	0x24 to 0x27	F (Failure)	Maintenance alarm
Warning	GOOD	Maintenance demanded	0xA8 to 0xAB	M (Maintenance)	Maintenance demanded
Logbook entry only	GOOD	ok	0x80 to 0x8E	-	-
Off					

*Diagnostic information pertaining to the electronics (diagnostic no.: 200 to 399)*

Diagnostic behavior (configurable)	Measured value status (fixed assignment)				Device diagnostics (fixed assignment)
	Quality	Quality Substatus	Coding (hex)	Category (NE107)	
Alarm	BAD	Maintenance alarm	0x24 to 0x27	F (Failure)	Maintenance alarm
Warning					
Logbook entry only	GOOD	ok	0x80 to 0x8E	-	-
Off					

*Diagnostic information pertaining to the configuration (diagnostic no.: 400 to 599)*





Diagnostic behavior (configurable)	Measured value status (fixed assignment)				Device diagnostics (fixed assignment)
	Quality	Quality Substatus	Coding (hex)	Category (NE107)	
Alarm	BAD	Process related	0x28 to 0x2B	F (Failure)	Invalid process condition
Warning	UNCERTAIN	Process related	0x78 to 0x7B	S (Out of specification)	Invalid process condition
Logbook entry only	GOOD	ok	0x80 to 0x8E	-	-
Off					

*Diagnostic information pertaining to the process (diagnostic no.: 800 to 999)*

Diagnostic behavior (configurable)	Measured value status (fixed assignment)				Device diagnostics (fixed assignment)
	Quality	Quality Substatus	Coding (hex)	Category (NE107)	
Alarm	BAD	Process related	0x28 to 0x2B	F (Failure)	Invalid process condition
Warning	UNCERTAIN	Process related	0x78 to 0x7B	S (Out of specification)	Invalid process condition
Logbook entry only	GOOD	ok	0x80 to 0x8E	-	-
Off					



## 12.5 Overview of diagnostic information

-  The amount of diagnostic information and the number of measured variables affected increase if the measuring device has one or more application packages.
-  In the case of some items of diagnostic information, the diagnostic behavior can be changed. Change the diagnostic information →  141
-  Operating conditions for displaying the following diagnostics information:
  - Diagnostics information 871: The process temperature is less than 2K from the saturated steam line.
  - Diagnostics information 872: The measured steam quality has dropped below the configured limit value for the steam quality (limit value: "Expert" menu → System → Diagnostic handling → Diagnostic limits → Steam quality limit).
  - Diagnostics information 873: The process temperature is ≤ 0 °C.
  - Diagnostics information 874: Wet steam detection/measurement is outside the specified limits for the following process parameters: pressure, temperature, velocity.
  - Diagnostics information 972: The degree of superheat has exceeded the configured limit value (limit value: "Expert" menu → System → Diagnostic handling → Diagnostic limits → Degrees of superheat limit).

### 12.5.1 Diagnostic of sensor

Diagnostic information		Remedy instructions	Influenced measured variables	
No.	Short text			
004	Sensor defective	1. Check plug connections 2. Change pre-amplifier 3. Change DSC sensor	<ul style="list-style-type: none"> <li>▪ Calculated saturated steam pressure</li> <li>▪ Density</li> <li>▪ Energy flow</li> <li>▪ Flow velocity</li> <li>▪ Heat flow difference</li> <li>▪ Low flow cut off</li> <li>▪ Mass flow</li> <li>▪ Total mass flow</li> <li>▪ Switch output status</li> <li>▪ Pressure</li> <li>▪ Reynolds number</li> <li>▪ Specific volume</li> <li>▪ Corrected volume flow</li> <li>▪ Steam quality</li> <li>▪ Degrees of superheat</li> <li>▪ Volume flow</li> </ul>	
	<b>Measured variable status</b>			
	Quality			Bad
	Quality substatus			Maintenance alarm
	Coding (hex)			0x24 to 0x27
	Status signal			F
	Diagnostic behavior			Alarm

Diagnostic information		Remedy instructions	Influenced measured variables	
No.	Short text			
022	Temperature sensor defective	1. Check plug connections 2. Change pre-amplifier 3. Change DSC sensor	<ul style="list-style-type: none"> <li>▪ Calculated saturated steam pressure</li> <li>▪ Density</li> <li>▪ Energy flow</li> <li>▪ Heat flow difference</li> <li>▪ Mass flow</li> <li>▪ Total mass flow</li> <li>▪ Pressure</li> <li>▪ Reynolds number</li> <li>▪ Specific volume</li> <li>▪ Corrected volume flow</li> <li>▪ Steam quality</li> <li>▪ Degrees of superheat</li> <li>▪ Temperature</li> </ul>	
	<b>Measured variable status [from the factory] <sup>1)</sup></b>			
	Quality			Bad
	Quality substatus			Maintenance alarm
	Coding (hex)			0x24 to 0x27
	Status signal			F
	Diagnostic behavior			Alarm

1) Diagnostic behavior can be changed. This causes the overall status of the measured variable to change.

Diagnostic information		Remedy instructions	Influenced measured variables	
No.	Short text			
046	Sensor limit exceeded	<ol style="list-style-type: none"> <li>1. Check plug connections</li> <li>2. Change pre-amplifier</li> <li>3. Change DSC sensor</li> </ol>	<ul style="list-style-type: none"> <li>▪ Calculated saturated steam pressure</li> <li>▪ Density</li> <li>▪ Energy flow</li> <li>▪ Flow velocity</li> <li>▪ Heat flow difference</li> <li>▪ Low flow cut off</li> <li>▪ Mass flow</li> <li>▪ Total mass flow</li> <li>▪ Switch output status</li> <li>▪ Pressure</li> <li>▪ Reynolds number</li> <li>▪ Specific volume</li> <li>▪ Corrected volume flow</li> <li>▪ Steam quality</li> <li>▪ Degrees of superheat</li> <li>▪ Volume flow</li> </ul>	
	<b>Measured variable status</b>			
	Quality			Good
	Quality substatus			Maintenance demanded
	Coding (hex)			0xA8 to 0xAB
	Status signal			S
	Diagnostic behavior			Warning

Diagnostic information		Remedy instructions	Influenced measured variables	
No.	Short text			
062	Sensor connection defective	<ol style="list-style-type: none"> <li>1. Check plug connections</li> <li>2. Change pre-amplifier</li> <li>3. Change DSC sensor</li> </ol>	<ul style="list-style-type: none"> <li>▪ Calculated saturated steam pressure</li> <li>▪ Density</li> <li>▪ Energy flow</li> <li>▪ Flow velocity</li> <li>▪ Heat flow difference</li> <li>▪ Low flow cut off</li> <li>▪ Mass flow</li> <li>▪ Total mass flow</li> <li>▪ Switch output status</li> <li>▪ Pressure</li> <li>▪ Reynolds number</li> <li>▪ Specific volume</li> <li>▪ Corrected volume flow</li> <li>▪ Steam quality</li> <li>▪ Degrees of superheat</li> <li>▪ Temperature</li> <li>▪ Volume flow</li> </ul>	
	<b>Measured variable status</b>			
	Quality			Bad
	Quality substatus			Maintenance alarm
	Coding (hex)			0x24 to 0x27
	Status signal			F
	Diagnostic behavior			Alarm

Diagnostic information		Remedy instructions	Influenced measured variables	
No.	Short text			
082	Data storage	<ol style="list-style-type: none"> <li>1. Change main electronic module</li> <li>2. Change sensor</li> </ol>	<ul style="list-style-type: none"> <li>▪ Calculated saturated steam pressure</li> <li>▪ Density</li> <li>▪ Energy flow</li> <li>▪ Flow velocity</li> <li>▪ Heat flow difference</li> <li>▪ Low flow cut off</li> <li>▪ Mass flow</li> <li>▪ Total mass flow</li> <li>▪ Switch output status</li> <li>▪ Pressure</li> <li>▪ Reynolds number</li> <li>▪ Specific volume</li> <li>▪ Corrected volume flow</li> <li>▪ Steam quality</li> <li>▪ Degrees of superheat</li> <li>▪ Temperature</li> <li>▪ Volume flow</li> </ul>	
	<b>Measured variable status</b>			
	Quality			Bad
	Quality substatus			Maintenance alarm
	Coding (hex)			0x24 to 0x27
	Status signal			F
	Diagnostic behavior			Alarm

Diagnostic information		Remedy instructions	Influenced measured variables	
No.	Short text			
083	Memory content	1. Restart device 2. Restore S-Dat data 3. Change sensor	<ul style="list-style-type: none"> <li>■ Calculated saturated steam pressure</li> <li>■ Density</li> <li>■ Energy flow</li> <li>■ Flow velocity</li> <li>■ Heat flow difference</li> <li>■ Low flow cut off</li> <li>■ Mass flow</li> <li>■ Total mass flow</li> <li>■ Switch output status</li> <li>■ Pressure</li> <li>■ Reynolds number</li> <li>■ Specific volume</li> <li>■ Corrected volume flow</li> <li>■ Steam quality</li> <li>■ Degrees of superheat</li> <li>■ Temperature</li> <li>■ Volume flow</li> </ul>	
	<b>Measured variable status</b>			
	Quality			Bad
	Quality substatus			Maintenance alarm
	Coding (hex)			0x24 to 0x27
	Status signal			F
	Diagnostic behavior			Alarm

Diagnostic information		Remedy instructions	Influenced measured variables	
No.	Short text			
114	Sensor leaky	Change DSC sensor	<ul style="list-style-type: none"> <li>■ Calculated saturated steam pressure</li> <li>■ Density</li> <li>■ Energy flow</li> <li>■ Flow velocity</li> <li>■ Heat flow difference</li> <li>■ Low flow cut off</li> <li>■ Mass flow</li> <li>■ Total mass flow</li> <li>■ Switch output status</li> <li>■ Pressure</li> <li>■ Reynolds number</li> <li>■ Specific volume</li> <li>■ Corrected volume flow</li> <li>■ Steam quality</li> <li>■ Degrees of superheat</li> <li>■ Volume flow</li> </ul>	
	<b>Measured variable status</b>			
	Quality			Bad
	Quality substatus			Maintenance alarm
	Coding (hex)			0x24 to 0x27
	Status signal			F
	Diagnostic behavior			Alarm

Diagnostic information		Remedy instructions	Influenced measured variables	
No.	Short text			
122	Temperature sensor defective	1. Check plug connections 2. Change pre-amplifier 3. Change DSC sensor	<ul style="list-style-type: none"> <li>■ Calculated saturated steam pressure</li> <li>■ Energy flow</li> <li>■ Heat flow difference</li> <li>■ Mass flow</li> <li>■ Total mass flow</li> <li>■ Corrected volume flow</li> <li>■ Steam quality</li> <li>■ Temperature</li> </ul>	
	<b>Measured variable status [from the factory] <sup>1)</sup></b>			
	Quality			Good
	Quality substatus			Maintenance demanded
	Coding (hex)			0xA8 to 0xAB
	Status signal			M
	Diagnostic behavior			Warning

1) Diagnostic behavior can be changed. This causes the overall status of the measured variable to change.

## 12.5.2 Diagnostic of electronic

Diagnostic information		Remedy instructions	Influenced measured variables	
No.	Short text			
242	Software incompatible	1. Check software 2. Flash or change main electronics module	<ul style="list-style-type: none"> <li>▪ Calculated saturated steam pressure</li> <li>▪ Density</li> <li>▪ Energy flow</li> <li>▪ Flow velocity</li> <li>▪ Heat flow difference</li> <li>▪ Low flow cut off</li> <li>▪ Mass flow</li> <li>▪ Total mass flow</li> <li>▪ Switch output status</li> <li>▪ Pressure</li> <li>▪ Reynolds number</li> <li>▪ Specific volume</li> <li>▪ Corrected volume flow</li> <li>▪ Steam quality</li> <li>▪ Degrees of superheat</li> <li>▪ Temperature</li> <li>▪ Volume flow</li> </ul>	
	<b>Measured variable status</b>			
	Quality			Bad
	Quality substatus			Maintenance alarm
	Coding (hex)			0x24 to 0x27
	Status signal			F
	Diagnostic behavior			Alarm

Diagnostic information		Remedy instructions	Influenced measured variables	
No.	Short text			
252	Modules incompatible	1. Check electronic modules 2. Change I/O or main electronic module	<ul style="list-style-type: none"> <li>▪ Calculated saturated steam pressure</li> <li>▪ Density</li> <li>▪ Energy flow</li> <li>▪ Flow velocity</li> <li>▪ Heat flow difference</li> <li>▪ Low flow cut off</li> <li>▪ Mass flow</li> <li>▪ Total mass flow</li> <li>▪ Switch output status</li> <li>▪ Pressure</li> <li>▪ Reynolds number</li> <li>▪ Specific volume</li> <li>▪ Corrected volume flow</li> <li>▪ Steam quality</li> <li>▪ Degrees of superheat</li> <li>▪ Temperature</li> <li>▪ Volume flow</li> </ul>	
	<b>Measured variable status</b>			
	Quality			Bad
	Quality substatus			Maintenance alarm
	Coding (hex)			0x24 to 0x27
	Status signal			F
	Diagnostic behavior			Alarm

Diagnostic information		Remedy instructions	Influenced measured variables	
No.	Short text			
261	Electronic modules	1. Restart device 2. Check electronic modules 3. Change I/O Modul or main electronics	<ul style="list-style-type: none"> <li>■ Calculated saturated steam pressure</li> <li>■ Density</li> <li>■ Energy flow</li> <li>■ Flow velocity</li> <li>■ Heat flow difference</li> <li>■ Low flow cut off</li> <li>■ Mass flow</li> <li>■ Total mass flow</li> <li>■ Switch output status</li> <li>■ Pressure</li> <li>■ Reynolds number</li> <li>■ Specific volume</li> <li>■ Corrected volume flow</li> <li>■ Steam quality</li> <li>■ Degrees of superheat</li> <li>■ Temperature</li> <li>■ Volume flow</li> </ul>	
	<b>Measured variable status</b>			
	Quality			Bad
	Quality substatus			Maintenance alarm
	Coding (hex)			0x24 to 0x27
	Status signal			F
Diagnostic behavior	Alarm			

Diagnostic information		Remedy instructions	Influenced measured variables	
No.	Short text			
262	Module connection	1. Check module connections 2. Change electronic modules	<ul style="list-style-type: none"> <li>■ Calculated saturated steam pressure</li> <li>■ Density</li> <li>■ Energy flow</li> <li>■ Flow velocity</li> <li>■ Heat flow difference</li> <li>■ Low flow cut off</li> <li>■ Mass flow</li> <li>■ Total mass flow</li> <li>■ Switch output status</li> <li>■ Pressure</li> <li>■ Reynolds number</li> <li>■ Specific volume</li> <li>■ Corrected volume flow</li> <li>■ Steam quality</li> <li>■ Degrees of superheat</li> <li>■ Temperature</li> <li>■ Volume flow</li> </ul>	
	<b>Measured variable status</b>			
	Quality			Bad
	Quality substatus			Maintenance alarm
	Coding (hex)			0x24 to 0x27
	Status signal			F
Diagnostic behavior	Alarm			

Diagnostic information		Remedy instructions	Influenced measured variables	
No.	Short text			
270	Main electronic failure	Change main electronic module	<ul style="list-style-type: none"> <li>■ Calculated saturated steam pressure</li> <li>■ Density</li> <li>■ Energy flow</li> <li>■ Flow velocity</li> <li>■ Heat flow difference</li> <li>■ Low flow cut off</li> <li>■ Mass flow</li> <li>■ Total mass flow</li> <li>■ Switch output status</li> <li>■ Pressure</li> <li>■ Reynolds number</li> <li>■ Specific volume</li> <li>■ Corrected volume flow</li> <li>■ Steam quality</li> <li>■ Degrees of superheat</li> <li>■ Temperature</li> <li>■ Volume flow</li> </ul>	
	<b>Measured variable status</b>			
	Quality			Bad
	Quality substatus			Maintenance alarm
	Coding (hex)			0x24 to 0x27
	Status signal			F
Diagnostic behavior	Alarm			

Diagnostic information		Remedy instructions	Influenced measured variables	
No.	Short text			
271	Main electronic failure	1. Restart device 2. Change main electronic module	<ul style="list-style-type: none"> <li>▪ Calculated saturated steam pressure</li> <li>▪ Density</li> <li>▪ Energy flow</li> <li>▪ Flow velocity</li> <li>▪ Heat flow difference</li> <li>▪ Low flow cut off</li> <li>▪ Mass flow</li> <li>▪ Total mass flow</li> <li>▪ Switch output status</li> <li>▪ Pressure</li> <li>▪ Reynolds number</li> <li>▪ Specific volume</li> <li>▪ Corrected volume flow</li> <li>▪ Steam quality</li> <li>▪ Degrees of superheat</li> <li>▪ Temperature</li> <li>▪ Volume flow</li> </ul>	
	<b>Measured variable status</b>			
	Quality			Bad
	Quality substatus			Maintenance alarm
	Coding (hex)			0x24 to 0x27
	Status signal			F
	Diagnostic behavior			Alarm

Diagnostic information		Remedy instructions	Influenced measured variables	
No.	Short text			
272	Main electronic failure	1. Restart device 2. Contact service	<ul style="list-style-type: none"> <li>▪ Calculated saturated steam pressure</li> <li>▪ Density</li> <li>▪ Energy flow</li> <li>▪ Flow velocity</li> <li>▪ Heat flow difference</li> <li>▪ Low flow cut off</li> <li>▪ Mass flow</li> <li>▪ Total mass flow</li> <li>▪ Switch output status</li> <li>▪ Pressure</li> <li>▪ Reynolds number</li> <li>▪ Specific volume</li> <li>▪ Corrected volume flow</li> <li>▪ Steam quality</li> <li>▪ Degrees of superheat</li> <li>▪ Temperature</li> <li>▪ Volume flow</li> </ul>	
	<b>Measured variable status</b>			
	Quality			Bad
	Quality substatus			Maintenance alarm
	Coding (hex)			0x24 to 0x27
	Status signal			F
	Diagnostic behavior			Alarm

Diagnostic information		Remedy instructions	Influenced measured variables	
No.	Short text			
273	Main electronic failure	1. Emergency operation via display 2. Change main electronics	<ul style="list-style-type: none"> <li>▪ Calculated saturated steam pressure</li> <li>▪ Density</li> <li>▪ Energy flow</li> <li>▪ Flow velocity</li> <li>▪ Heat flow difference</li> <li>▪ Low flow cut off</li> <li>▪ Mass flow</li> <li>▪ Total mass flow</li> <li>▪ Switch output status</li> <li>▪ Pressure</li> <li>▪ Reynolds number</li> <li>▪ Specific volume</li> <li>▪ Corrected volume flow</li> <li>▪ Steam quality</li> <li>▪ Degrees of superheat</li> <li>▪ Temperature</li> <li>▪ Volume flow</li> </ul>	
	<b>Measured variable status</b>			
	Quality			Bad
	Quality substatus			Maintenance alarm
	Coding (hex)			0x24 to 0x27
	Status signal			F
	Diagnostic behavior			Alarm

Diagnostic information		Remedy instructions	Influenced measured variables	
No.	Short text			
275	I/O module failure	Change I/O module	<ul style="list-style-type: none"> <li>■ Calculated saturated steam pressure</li> <li>■ Density</li> <li>■ Energy flow</li> <li>■ Flow velocity</li> <li>■ Heat flow difference</li> <li>■ Low flow cut off</li> <li>■ Mass flow</li> <li>■ Total mass flow</li> <li>■ Switch output status</li> <li>■ Pressure</li> <li>■ Reynolds number</li> <li>■ Specific volume</li> <li>■ Corrected volume flow</li> <li>■ Steam quality</li> <li>■ Degrees of superheat</li> <li>■ Temperature</li> <li>■ Volume flow</li> </ul>	
	<b>Measured variable status</b>			
	Quality			Bad
	Quality substatus			Maintenance alarm
	Coding (hex)			0x24 to 0x27
	Status signal			F
	Diagnostic behavior			Alarm

Diagnostic information		Remedy instructions	Influenced measured variables	
No.	Short text			
276	I/O module failure	<ol style="list-style-type: none"> <li>1. Restart device</li> <li>2. Change I/O module</li> </ol>	<ul style="list-style-type: none"> <li>■ Calculated saturated steam pressure</li> <li>■ Density</li> <li>■ Energy flow</li> <li>■ Flow velocity</li> <li>■ Heat flow difference</li> <li>■ Low flow cut off</li> <li>■ Mass flow</li> <li>■ Total mass flow</li> <li>■ Switch output status</li> <li>■ Pressure</li> <li>■ Reynolds number</li> <li>■ Specific volume</li> <li>■ Corrected volume flow</li> <li>■ Steam quality</li> <li>■ Degrees of superheat</li> <li>■ Temperature</li> <li>■ Volume flow</li> </ul>	
	<b>Measured variable status</b>			
	Quality			Bad
	Quality substatus			Maintenance alarm
	Coding (hex)			0x24 to 0x27
	Status signal			F
	Diagnostic behavior			Alarm

Diagnostic information		Remedy instructions	Influenced measured variables	
No.	Short text			
277	Electronics defective	<ol style="list-style-type: none"> <li>1. Change pre-amplifier</li> <li>2. Change main electronic module</li> </ol>	<ul style="list-style-type: none"> <li>■ Calculated saturated steam pressure</li> <li>■ Density</li> <li>■ Energy flow</li> <li>■ Flow velocity</li> <li>■ Heat flow difference</li> <li>■ Low flow cut off</li> <li>■ Mass flow</li> <li>■ Total mass flow</li> <li>■ Switch output status</li> <li>■ Pressure</li> <li>■ Reynolds number</li> <li>■ Specific volume</li> <li>■ Corrected volume flow</li> <li>■ Steam quality</li> <li>■ Degrees of superheat</li> <li>■ Temperature</li> <li>■ Volume flow</li> </ul>	
	<b>Measured variable status</b>			
	Quality			Bad
	Quality substatus			Maintenance alarm
	Coding (hex)			0x24 to 0x27
	Status signal			F
	Diagnostic behavior			Alarm

Diagnostic information		Remedy instructions	Influenced measured variables	
No.	Short text			
282	Data storage	1. Restart device 2. Contact service	<ul style="list-style-type: none"> <li>■ Calculated saturated steam pressure</li> <li>■ Density</li> <li>■ Energy flow</li> <li>■ Flow velocity</li> <li>■ Heat flow difference</li> <li>■ Low flow cut off</li> <li>■ Mass flow</li> <li>■ Total mass flow</li> <li>■ Switch output status</li> <li>■ Pressure</li> <li>■ Reynolds number</li> <li>■ Specific volume</li> <li>■ Corrected volume flow</li> <li>■ Steam quality</li> <li>■ Degrees of superheat</li> <li>■ Temperature</li> <li>■ Volume flow</li> </ul>	
	<b>Measured variable status</b>			
	Quality			Bad
	Quality substatus			Maintenance alarm
	Coding (hex)			0x24 to 0x27
	Status signal			F
	Diagnostic behavior			Alarm

Diagnostic information		Remedy instructions	Influenced measured variables	
No.	Short text			
283	Memory content	1. Transfer data or reset device 2. Contact service	<ul style="list-style-type: none"> <li>■ Calculated saturated steam pressure</li> <li>■ Density</li> <li>■ Energy flow</li> <li>■ Flow velocity</li> <li>■ Heat flow difference</li> <li>■ Low flow cut off</li> <li>■ Mass flow</li> <li>■ Total mass flow</li> <li>■ Switch output status</li> <li>■ Pressure</li> <li>■ Reynolds number</li> <li>■ Specific volume</li> <li>■ Corrected volume flow</li> <li>■ Steam quality</li> <li>■ Degrees of superheat</li> <li>■ Temperature</li> <li>■ Volume flow</li> </ul>	
	<b>Measured variable status</b>			
	Quality			Bad
	Quality substatus			Maintenance alarm
	Coding (hex)			0x24 to 0x27
	Status signal			F
	Diagnostic behavior			Alarm

Diagnostic information		Remedy instructions	Influenced measured variables	
No.	Short text			
302	Device verification active	Device verification active, please wait.	<ul style="list-style-type: none"> <li>■ Calculated saturated steam pressure</li> <li>■ Density</li> <li>■ Energy flow</li> <li>■ Flow velocity</li> <li>■ Heat flow difference</li> <li>■ Low flow cut off</li> <li>■ Mass flow</li> <li>■ Total mass flow</li> <li>■ Switch output status</li> <li>■ Pressure</li> <li>■ Reynolds number</li> <li>■ Specific volume</li> <li>■ Corrected volume flow</li> <li>■ Steam quality</li> <li>■ Degrees of superheat</li> <li>■ Temperature</li> <li>■ Volume flow</li> </ul>	
	<b>Measured variable status</b>			
	Quality			Good
	Quality substatus			Function check
	Coding (hex)			0xBC to 0xBF
	Status signal			C
	Diagnostic behavior			Warning



Diagnostic information		Remedy instructions	Influenced measured variables	
No.	Short text			
311	Electronic failure	1. Transfer data or reset device 2. Contact service	<ul style="list-style-type: none"> <li>■ Calculated saturated steam pressure</li> <li>■ Density</li> <li>■ Energy flow</li> <li>■ Flow velocity</li> <li>■ Heat flow difference</li> <li>■ Low flow cut off</li> <li>■ Mass flow</li> <li>■ Total mass flow</li> <li>■ Switch output status</li> <li>■ Pressure</li> <li>■ Reynolds number</li> <li>■ Specific volume</li> <li>■ Corrected volume flow</li> <li>■ Steam quality</li> <li>■ Degrees of superheat</li> <li>■ Temperature</li> <li>■ Volume flow</li> </ul>	
	<b>Measured variable status</b>			
	Quality			Bad
	Quality substatus			Maintenance alarm
	Coding (hex)			0x24 to 0x27
	Status signal			F
Diagnostic behavior	Alarm			

Diagnostic information		Remedy instructions	Influenced measured variables	
No.	Short text			
311	Electronic failure	Maintenance required! 1. Do not perform reset 2. Contact service	<ul style="list-style-type: none"> <li>■ Calculated saturated steam pressure</li> <li>■ Density</li> <li>■ Energy flow</li> <li>■ Flow velocity</li> <li>■ Heat flow difference</li> <li>■ Low flow cut off</li> <li>■ Mass flow</li> <li>■ Total mass flow</li> <li>■ Switch output status</li> <li>■ Pressure</li> <li>■ Reynolds number</li> <li>■ Specific volume</li> <li>■ Corrected volume flow</li> <li>■ Steam quality</li> <li>■ Degrees of superheat</li> <li>■ Temperature</li> <li>■ Volume flow</li> </ul>	
	<b>Measured variable status</b>			
	Quality			Bad
	Quality substatus			Maintenance alarm
	Coding (hex)			0x24 to 0x27
	Status signal			M
Diagnostic behavior	Warning			

Diagnostic information		Remedy instructions	Influenced measured variables	
No.	Short text			
350	Pre-amplifier defective	Change pre-amplifier	<ul style="list-style-type: none"> <li>▪ Calculated saturated steam pressure</li> <li>▪ Density</li> <li>▪ Energy flow</li> <li>▪ Flow velocity</li> <li>▪ Heat flow difference</li> <li>▪ Low flow cut off</li> <li>▪ Mass flow</li> <li>▪ Total mass flow</li> <li>▪ Switch output status</li> <li>▪ Pressure</li> <li>▪ Reynolds number</li> <li>▪ Specific volume</li> <li>▪ Corrected volume flow</li> <li>▪ Steam quality</li> <li>▪ Degrees of superheat</li> <li>▪ Temperature</li> <li>▪ Volume flow</li> </ul>	
	<b>Measured variable status [from the factory] <sup>1)</sup></b>			
	Quality			Bad
	Quality substatus			Maintenance alarm
	Coding (hex)			0x24 to 0x27
	Status signal			F
	Diagnostic behavior			Alarm

1) Diagnostic behavior can be changed. This causes the overall status of the measured variable to change.

Diagnostic information		Remedy instructions	Influenced measured variables	
No.	Short text			
351	Pre-amplifier defective	Change pre-amplifier	<ul style="list-style-type: none"> <li>▪ Calculated saturated steam pressure</li> <li>▪ Density</li> <li>▪ Energy flow</li> <li>▪ Flow velocity</li> <li>▪ Heat flow difference</li> <li>▪ Low flow cut off</li> <li>▪ Mass flow</li> <li>▪ Total mass flow</li> <li>▪ Switch output status</li> <li>▪ Pressure</li> <li>▪ Reynolds number</li> <li>▪ Specific volume</li> <li>▪ Corrected volume flow</li> <li>▪ Steam quality</li> <li>▪ Degrees of superheat</li> <li>▪ Volume flow</li> </ul>	
	<b>Measured variable status</b>			
	Quality			Bad
	Quality substatus			Maintenance alarm
	Coding (hex)			0x24 to 0x27
	Status signal			F
	Diagnostic behavior			Alarm

Diagnostic information		Remedy instructions	Influenced measured variables	
No.	Short text			
370	Pre-amplifier defective	<ol style="list-style-type: none"> <li>1. Check plug connections</li> <li>2. Check cabel connection of remote version</li> <li>3. Change pre-amplifier or main electronic module</li> </ol>	<ul style="list-style-type: none"> <li>▪ Calculated saturated steam pressure</li> <li>▪ Density</li> <li>▪ Energy flow</li> <li>▪ Flow velocity</li> <li>▪ Heat flow difference</li> <li>▪ Low flow cut off</li> <li>▪ Mass flow</li> <li>▪ Total mass flow</li> <li>▪ Switch output status</li> <li>▪ Pressure</li> <li>▪ Reynolds number</li> <li>▪ Specific volume</li> <li>▪ Corrected volume flow</li> <li>▪ Steam quality</li> <li>▪ Degrees of superheat</li> <li>▪ Temperature</li> <li>▪ Volume flow</li> </ul>	
	<b>Measured variable status</b>			
	Quality			Bad
	Quality substatus			Maintenance alarm
	Coding (hex)			0x24 to 0x27
	Status signal			F
	Diagnostic behavior			Alarm

Diagnostic information		Remedy instructions	Influenced measured variables	
No.	Short text			
371	Temperature sensor defective	1. Check plug connections 2. Change pre-amplifier 3. Change DSC sensor	<ul style="list-style-type: none"> <li>■ Calculated saturated steam pressure</li> <li>■ Density</li> <li>■ Energy flow</li> <li>■ Flow velocity</li> <li>■ Heat flow difference</li> <li>■ Low flow cut off</li> <li>■ Mass flow</li> <li>■ Total mass flow</li> <li>■ Switch output status</li> <li>■ Pressure</li> <li>■ Reynolds number</li> <li>■ Specific volume</li> <li>■ Corrected volume flow</li> <li>■ Steam quality</li> <li>■ Degrees of superheat</li> <li>■ Temperature</li> <li>■ Volume flow</li> </ul>	
	<b>Measured variable status [from the factory] <sup>1)</sup></b>			
	Quality			Uncertain
	Quality substatus			Process related
	Coding (hex)			0x78 to 0x7B
	Status signal			M
	Diagnostic behavior			Warning

1) Diagnostic behavior can be changed. This causes the overall status of the measured variable to change.

### 12.5.3 Diagnostic of configuration

Diagnostic information		Remedy instructions	Influenced measured variables	
No.	Short text			
410	Data transfer	1. Check connection 2. Retry data transfer	<ul style="list-style-type: none"> <li>■ Calculated saturated steam pressure</li> <li>■ Density</li> <li>■ Energy flow</li> <li>■ Flow velocity</li> <li>■ Heat flow difference</li> <li>■ Low flow cut off</li> <li>■ Mass flow</li> <li>■ Total mass flow</li> <li>■ Switch output status</li> <li>■ Pressure</li> <li>■ Reynolds number</li> <li>■ Specific volume</li> <li>■ Corrected volume flow</li> <li>■ Steam quality</li> <li>■ Degrees of superheat</li> <li>■ Temperature</li> <li>■ Volume flow</li> </ul>	
	<b>Measured variable status</b>			
	Quality			Bad
	Quality substatus			Maintenance alarm
	Coding (hex)			0x24 to 0x27
	Status signal			F
	Diagnostic behavior			Alarm

Diagnostic information		Remedy instructions	Influenced measured variables	
No.	Short text			
412	Processing Download	Download active, please wait	<ul style="list-style-type: none"> <li>▪ Calculated saturated steam pressure</li> <li>▪ Density</li> <li>▪ Energy flow</li> <li>▪ Flow velocity</li> <li>▪ Heat flow difference</li> <li>▪ Low flow cut off</li> <li>▪ Mass flow</li> <li>▪ Total mass flow</li> <li>▪ Switch output status</li> <li>▪ Pressure</li> <li>▪ Reynolds number</li> <li>▪ Specific volume</li> <li>▪ Corrected volume flow</li> <li>▪ Steam quality</li> <li>▪ Degrees of superheat</li> <li>▪ Temperature</li> <li>▪ Volume flow</li> </ul>	
	<b>Measured variable status</b>			
	Quality			Uncertain
	Quality substatus			Initial value
	Coding (hex)			0x4C to 0x4F
	Status signal			C
	Diagnostic behavior			Warning

Diagnostic information		Remedy instructions	Influenced measured variables	
No.	Short text			
437	Configuration incompatible	<ol style="list-style-type: none"> <li>1. Restart device</li> <li>2. Contact service</li> </ol>	<ul style="list-style-type: none"> <li>▪ Calculated saturated steam pressure</li> <li>▪ Density</li> <li>▪ Energy flow</li> <li>▪ Flow velocity</li> <li>▪ Heat flow difference</li> <li>▪ Low flow cut off</li> <li>▪ Mass flow</li> <li>▪ Total mass flow</li> <li>▪ Switch output status</li> <li>▪ Pressure</li> <li>▪ Reynolds number</li> <li>▪ Specific volume</li> <li>▪ Corrected volume flow</li> <li>▪ Steam quality</li> <li>▪ Degrees of superheat</li> <li>▪ Temperature</li> <li>▪ Volume flow</li> </ul>	
	<b>Measured variable status</b>			
	Quality			Bad
	Quality substatus			Maintenance alarm
	Coding (hex)			0x24 to 0x27
	Status signal			F
	Diagnostic behavior			Alarm

Diagnostic information		Remedy instructions	Influenced measured variables	
No.	Short text			
438	Dataset	<ol style="list-style-type: none"> <li>1. Check data set file</li> <li>2. Check device configuration</li> <li>3. Up- and download new configuration</li> </ol>	<ul style="list-style-type: none"> <li>▪ Calculated saturated steam pressure</li> <li>▪ Density</li> <li>▪ Energy flow</li> <li>▪ Flow velocity</li> <li>▪ Heat flow difference</li> <li>▪ Low flow cut off</li> <li>▪ Mass flow</li> <li>▪ Total mass flow</li> <li>▪ Switch output status</li> <li>▪ Pressure</li> <li>▪ Reynolds number</li> <li>▪ Specific volume</li> <li>▪ Corrected volume flow</li> <li>▪ Steam quality</li> <li>▪ Degrees of superheat</li> <li>▪ Temperature</li> <li>▪ Volume flow</li> </ul>	
	<b>Measured variable status</b>			
	Quality			Uncertain
	Quality substatus			Maintenance demanded
	Coding (hex)			0x68 to 0x6B
	Status signal			M
	Diagnostic behavior			Warning

Diagnostic information		Remedy instructions	Influenced measured variables	
No.	Short text			
442	Frequency output	1. Check process 2. Check frequency output settings	-	
	<b>Measured variable status [from the factory] <sup>1)</sup></b>			
	Quality			Good
	Quality substatus			Ok
	Coding (hex)			0x80 to 0x83
	Status signal			S
	Diagnostic behavior			Warning

1) Diagnostic behavior can be changed. This causes the overall status of the measured variable to change.

Diagnostic information		Remedy instructions	Influenced measured variables	
No.	Short text			
442	Frequency output	1. Check process 2. Check frequency output settings	-	
	<b>Measured variable status</b>			
	Quality			Good
	Quality substatus			Ok
	Coding (hex)			0x80 to 0x83
	Status signal			S
	Diagnostic behavior			Warning

Diagnostic information		Remedy instructions	Influenced measured variables	
No.	Short text			
443	Pulse output	1. Check process 2. Check pulse output settings	-	
	<b>Measured variable status [from the factory] <sup>1)</sup></b>			
	Quality			Good
	Quality substatus			Ok
	Coding (hex)			0x80 to 0x83
	Status signal			S
	Diagnostic behavior			Warning

1) Diagnostic behavior can be changed. This causes the overall status of the measured variable to change.

Diagnostic information		Remedy instructions	Influenced measured variables	
No.	Short text			
443	Pulse output	1. Check process 2. Check pulse output settings	-	
	<b>Measured variable status</b>			
	Quality			Good
	Quality substatus			Ok
	Coding (hex)			0x80 to 0x83
	Status signal			S
	Diagnostic behavior			Warning

Diagnostic information		Remedy instructions	Influenced measured variables	
No.	Short text			
453	Flow override	Deactivate flow override	<ul style="list-style-type: none"> <li>▪ Calculated saturated steam pressure</li> <li>▪ Density</li> <li>▪ Energy flow</li> <li>▪ Flow velocity</li> <li>▪ Heat flow difference</li> <li>▪ Low flow cut off</li> <li>▪ Mass flow</li> <li>▪ Total mass flow</li> <li>▪ Switch output status</li> <li>▪ Pressure</li> <li>▪ Reynolds number</li> <li>▪ Specific volume</li> <li>▪ Corrected volume flow</li> <li>▪ Steam quality</li> <li>▪ Degrees of superheat</li> <li>▪ Temperature</li> <li>▪ Volume flow</li> </ul>	
	<b>Measured variable status</b>			
	Quality			Good
	Quality substatus			Function check
	Coding (hex)			0xBC to 0xBF
	Status signal			C
	Diagnostic behavior			Warning

Diagnostic information		Remedy instructions	Influenced measured variables	
No.	Short text			
482	Block in OOS	Set Block in AUTO mode	-	
	<b>Measured variable status</b>			
	Quality			Good
	Quality substatus			Ok
	Coding (hex)			0x80 to 0x83
	Status signal			F
	Diagnostic behavior			Alarm

Diagnostic information		Remedy instructions	Influenced measured variables	
No.	Short text			
484	Simulation failure mode	Deactivate simulation	<ul style="list-style-type: none"> <li>▪ Calculated saturated steam pressure</li> <li>▪ Density</li> <li>▪ Energy flow</li> <li>▪ Flow velocity</li> <li>▪ Heat flow difference</li> <li>▪ Low flow cut off</li> <li>▪ Mass flow</li> <li>▪ Total mass flow</li> <li>▪ Switch output status</li> <li>▪ Pressure</li> <li>▪ Reynolds number</li> <li>▪ Specific volume</li> <li>▪ Corrected volume flow</li> <li>▪ Steam quality</li> <li>▪ Degrees of superheat</li> <li>▪ Temperature</li> <li>▪ Volume flow</li> </ul>	
	<b>Measured variable status</b>			
	Quality			Bad
	Quality substatus			Function check
	Coding (hex)			0x3C to 0x3F
	Status signal			C
	Diagnostic behavior			Alarm

Diagnostic information		Remedy instructions	Influenced measured variables
No.	Short text		
485	Simulation measured variable		Deactivate simulation <ul style="list-style-type: none"> <li>■ Calculated saturated steam pressure</li> <li>■ Density</li> <li>■ Energy flow</li> <li>■ Flow velocity</li> <li>■ Heat flow difference</li> <li>■ Low flow cut off</li> <li>■ Mass flow</li> <li>■ Total mass flow</li> <li>■ Switch output status</li> <li>■ Pressure</li> <li>■ Reynolds number</li> <li>■ Specific volume</li> <li>■ Corrected volume flow</li> <li>■ Steam quality</li> <li>■ Degrees of superheat</li> <li>■ Temperature</li> <li>■ Volume flow</li> </ul>
	<b>Measured variable status</b>		
	Quality	Good	
	Quality substatus	Function check	
	Coding (hex)	0xBC to 0xBF	
	Status signal	C	
	Diagnostic behavior	Warning	

Diagnostic information		Remedy instructions	Influenced measured variables
No.	Short text		
492	Simulation frequency output		Deactivate simulation frequency output <ul style="list-style-type: none"> <li>■ Calculated saturated steam pressure</li> <li>■ Energy flow</li> <li>■ Flow velocity</li> <li>■ Heat flow difference</li> <li>■ Low flow cut off</li> <li>■ Mass flow</li> <li>■ Total mass flow</li> <li>■ Switch output status</li> <li>■ Corrected volume flow</li> <li>■ Steam quality</li> <li>■ Temperature</li> <li>■ Volume flow</li> </ul>
	<b>Measured variable status</b>		
	Quality	Good	
	Quality substatus	Ok	
	Coding (hex)	0x80 to 0x83	
	Status signal	C	
	Diagnostic behavior	Warning	

Diagnostic information		Remedy instructions	Influenced measured variables
No.	Short text		
493	Simulation pulse output		Deactivate simulation pulse output <ul style="list-style-type: none"> <li>■ Calculated saturated steam pressure</li> <li>■ Energy flow</li> <li>■ Flow velocity</li> <li>■ Heat flow difference</li> <li>■ Low flow cut off</li> <li>■ Mass flow</li> <li>■ Total mass flow</li> <li>■ Switch output status</li> <li>■ Corrected volume flow</li> <li>■ Steam quality</li> <li>■ Temperature</li> <li>■ Volume flow</li> </ul>
	<b>Measured variable status</b>		
	Quality	Good	
	Quality substatus	Ok	
	Coding (hex)	0x80 to 0x83	
	Status signal	C	
	Diagnostic behavior	Warning	

Diagnostic information		Remedy instructions	Influenced measured variables	
No.	Short text			
494	Switch output simulation	Deactivate simulation switch output	<ul style="list-style-type: none"> <li>▪ Calculated saturated steam pressure</li> <li>▪ Energy flow</li> <li>▪ Flow velocity</li> <li>▪ Heat flow difference</li> <li>▪ Low flow cut off</li> <li>▪ Mass flow</li> <li>▪ Total mass flow</li> <li>▪ Switch output status</li> <li>▪ Corrected volume flow</li> <li>▪ Steam quality</li> <li>▪ Temperature</li> <li>▪ Volume flow</li> </ul>	
	<b>Measured variable status</b>			
	Quality			Good
	Quality substatus			Function check
	Coding (hex)			0xBC to 0xBF
	Status signal			C
	Diagnostic behavior			Warning

Diagnostic information		Remedy instructions	Influenced measured variables	
No.	Short text			
495	Simulation diagnostic event	Deactivate simulation	-	
	<b>Measured variable status</b>			
	Quality			Good
	Quality substatus			Ok
	Coding (hex)			0x80 to 0x83
	Status signal			C
	Diagnostic behavior			Warning

Diagnostic information		Remedy instructions	Influenced measured variables	
No.	Short text			
497	Simulation block output	Deactivate simulation	-	
	<b>Measured variable status</b>			
	Quality			Good
	Quality substatus			Ok
	Coding (hex)			0x80 to 0x83
	Status signal			C
	Diagnostic behavior			Warning

Diagnostic information		Remedy instructions	Influenced measured variables	
No.	Short text			
538	Flow computer configuration incorrect	Check input value (pressure, temperature)	<ul style="list-style-type: none"> <li>▪ Calculated saturated steam pressure</li> <li>▪ Density</li> <li>▪ Energy flow</li> <li>▪ Heat flow difference</li> <li>▪ Low flow cut off</li> <li>▪ Mass flow</li> <li>▪ Total mass flow</li> <li>▪ Switch output status</li> <li>▪ Pressure</li> <li>▪ Reynolds number</li> <li>▪ Specific volume</li> <li>▪ Corrected volume flow</li> <li>▪ Steam quality</li> <li>▪ Degrees of superheat</li> </ul>	
	<b>Measured variable status</b>			
	Quality			Good
	Quality substatus			Function check
	Coding (hex)			0xBC to 0xBF
	Status signal			S
	Diagnostic behavior			Warning



Diagnostic information		Remedy instructions	Influenced measured variables	
No.	Short text			
539	Flow computer configuration incorrect	1. Check input value (pressure, temperature) 2. Check allowed values of the medium properties	<ul style="list-style-type: none"> <li>■ Calculated saturated steam pressure</li> <li>■ Density</li> <li>■ Energy flow</li> <li>■ Flow velocity</li> <li>■ Heat flow difference</li> <li>■ Low flow cut off</li> <li>■ Mass flow</li> <li>■ Total mass flow</li> <li>■ Switch output status</li> <li>■ Pressure</li> <li>■ Reynolds number</li> <li>■ Specific volume</li> <li>■ Corrected volume flow</li> <li>■ Steam quality</li> <li>■ Degrees of superheat</li> <li>■ Volume flow</li> </ul>	
	<b>Measured variable status</b>			
	Quality			Bad
	Quality substatus			Function check
	Coding (hex)			0x3C to 0x3F
	Status signal			S
Diagnostic behavior	Alarm			

Diagnostic information		Remedy instructions	Influenced measured variables	
No.	Short text			
540	Flow computer configuration incorrect	Check entered reference value using the document Operating Instructions	<ul style="list-style-type: none"> <li>■ Calculated saturated steam pressure</li> <li>■ Density</li> <li>■ Energy flow</li> <li>■ Heat flow difference</li> <li>■ Low flow cut off</li> <li>■ Mass flow</li> <li>■ Total mass flow</li> <li>■ Switch output status</li> <li>■ Pressure</li> <li>■ Reynolds number</li> <li>■ Specific volume</li> <li>■ Corrected volume flow</li> <li>■ Steam quality</li> <li>■ Degrees of superheat</li> </ul>	
	<b>Measured variable status</b>			
	Quality			Good
	Quality substatus			Function check
	Coding (hex)			0xBC to 0xBF
	Status signal			S
Diagnostic behavior	Warning			

Diagnostic information		Remedy instructions	Influenced measured variables	
No.	Short text			
570	Inverted delta heat	Check configuration of mounting location (parameter Installation direction)	Heat flow difference	
	<b>Measured variable status</b>			
	Quality			Bad
	Quality substatus			Function check
	Coding (hex)			0x3C to 0x3F
	Status signal			F
Diagnostic behavior	Alarm			

## 12.5.4 Diagnostic of process

Diagnostic information		Remedy instructions	Influenced measured variables	
No.	Short text			
801	Supply voltage too low	Increase supply voltage	<ul style="list-style-type: none"> <li>▪ Calculated saturated steam pressure</li> <li>▪ Density</li> <li>▪ Energy flow</li> <li>▪ Flow velocity</li> <li>▪ Heat flow difference</li> <li>▪ Low flow cut off</li> <li>▪ Mass flow</li> <li>▪ Total mass flow</li> <li>▪ Switch output status</li> <li>▪ Pressure</li> <li>▪ Reynolds number</li> <li>▪ Specific volume</li> <li>▪ Corrected volume flow</li> <li>▪ Steam quality</li> <li>▪ Degrees of superheat</li> <li>▪ Temperature</li> <li>▪ Volume flow</li> </ul>	
	<b>Measured variable status</b>			
	Quality			Uncertain
	Quality substatus			Process related
	Coding (hex)			0x78 to 0x7B
	Status signal			S
	Diagnostic behavior			Warning

Diagnostic information		Remedy instructions	Influenced measured variables	
No.	Short text			
828	Ambient temperature too low	Increase ambient temperature of pre-amplifier	<ul style="list-style-type: none"> <li>▪ Calculated saturated steam pressure</li> <li>▪ Density</li> <li>▪ Energy flow</li> <li>▪ Flow velocity</li> <li>▪ Heat flow difference</li> <li>▪ Low flow cut off</li> <li>▪ Mass flow</li> <li>▪ Total mass flow</li> <li>▪ Switch output status</li> <li>▪ Pressure</li> <li>▪ Reynolds number</li> <li>▪ Specific volume</li> <li>▪ Corrected volume flow</li> <li>▪ Steam quality</li> <li>▪ Degrees of superheat</li> <li>▪ Temperature</li> <li>▪ Volume flow</li> </ul>	
	<b>Measured variable status [from the factory] <sup>1)</sup></b>			
	Quality			Uncertain
	Quality substatus			Process related
	Coding (hex)			0x78 to 0x7B
	Status signal			S
	Diagnostic behavior			Warning

1) Diagnostic behavior can be changed. This causes the overall status of the measured variable to change.

Diagnostic information		Remedy instructions	Influenced measured variables	
No.	Short text			
829	Ambient temperature too high	Reduce ambient temperature of pre-amplifier	<ul style="list-style-type: none"> <li>■ Calculated saturated steam pressure</li> <li>■ Density</li> <li>■ Energy flow</li> <li>■ Flow velocity</li> <li>■ Heat flow difference</li> <li>■ Low flow cut off</li> <li>■ Mass flow</li> <li>■ Total mass flow</li> <li>■ Switch output status</li> <li>■ Pressure</li> <li>■ Reynolds number</li> <li>■ Specific volume</li> <li>■ Corrected volume flow</li> <li>■ Steam quality</li> <li>■ Degrees of superheat</li> <li>■ Temperature</li> <li>■ Volume flow</li> </ul>	
	<b>Measured variable status [from the factory] <sup>1)</sup></b>			
	Quality			Uncertain
	Quality substatus			Process related
	Coding (hex)			0x78 to 0x7B
	Status signal			S
	Diagnostic behavior			Warning

1) Diagnostic behavior can be changed. This causes the overall status of the measured variable to change.

Diagnostic information		Remedy instructions	Influenced measured variables	
No.	Short text			
832	Electronic temperature too high	Reduce ambient temperature	<ul style="list-style-type: none"> <li>■ Calculated saturated steam pressure</li> <li>■ Density</li> <li>■ Energy flow</li> <li>■ Flow velocity</li> <li>■ Heat flow difference</li> <li>■ Low flow cut off</li> <li>■ Mass flow</li> <li>■ Total mass flow</li> <li>■ Switch output status</li> <li>■ Pressure</li> <li>■ Reynolds number</li> <li>■ Specific volume</li> <li>■ Corrected volume flow</li> <li>■ Steam quality</li> <li>■ Degrees of superheat</li> <li>■ Temperature</li> <li>■ Volume flow</li> </ul>	
	<b>Measured variable status [from the factory] <sup>1)</sup></b>			
	Quality			Uncertain
	Quality substatus			Process related
	Coding (hex)			0x78 to 0x7B
	Status signal			S
	Diagnostic behavior			Warning

1) Diagnostic behavior can be changed. This causes the overall status of the measured variable to change.

Diagnostic information		Remedy instructions	Influenced measured variables	
No.	Short text			
833	Electronic temperature too low	Increase ambient temperature	<ul style="list-style-type: none"> <li>▪ Calculated saturated steam pressure</li> <li>▪ Density</li> <li>▪ Energy flow</li> <li>▪ Flow velocity</li> <li>▪ Heat flow difference</li> <li>▪ Low flow cut off</li> <li>▪ Mass flow</li> <li>▪ Total mass flow</li> <li>▪ Switch output status</li> <li>▪ Pressure</li> <li>▪ Reynolds number</li> <li>▪ Specific volume</li> <li>▪ Corrected volume flow</li> <li>▪ Steam quality</li> <li>▪ Degrees of superheat</li> <li>▪ Temperature</li> <li>▪ Volume flow</li> </ul>	
	<b>Measured variable status [from the factory] <sup>1)</sup></b>			
	Quality			Uncertain
	Quality substatus			Process related
	Coding (hex)			0x78 to 0x7B
	Status signal			S
	Diagnostic behavior			Warning

1) Diagnostic behavior can be changed. This causes the overall status of the measured variable to change.

Diagnostic information		Remedy instructions	Influenced measured variables	
No.	Short text			
834	Process temperature too high	Reduce process temperature	<ul style="list-style-type: none"> <li>▪ Calculated saturated steam pressure</li> <li>▪ Density</li> <li>▪ Energy flow</li> <li>▪ Flow velocity</li> <li>▪ Heat flow difference</li> <li>▪ Low flow cut off</li> <li>▪ Mass flow</li> <li>▪ Total mass flow</li> <li>▪ Switch output status</li> <li>▪ Pressure</li> <li>▪ Reynolds number</li> <li>▪ Specific volume</li> <li>▪ Corrected volume flow</li> <li>▪ Steam quality</li> <li>▪ Degrees of superheat</li> <li>▪ Volume flow</li> </ul>	
	<b>Measured variable status [from the factory] <sup>1)</sup></b>			
	Quality			Uncertain
	Quality substatus			Process related
	Coding (hex)			0x78 to 0x7B
	Status signal			S
	Diagnostic behavior			Warning

1) Diagnostic behavior can be changed. This causes the overall status of the measured variable to change.

Diagnostic information		Remedy instructions	Influenced measured variables	
No.	Short text			
835	Process temperature too low	Increase process temperature	<ul style="list-style-type: none"> <li>■ Calculated saturated steam pressure</li> <li>■ Density</li> <li>■ Energy flow</li> <li>■ Flow velocity</li> <li>■ Heat flow difference</li> <li>■ Low flow cut off</li> <li>■ Mass flow</li> <li>■ Total mass flow</li> <li>■ Switch output status</li> <li>■ Pressure</li> <li>■ Reynolds number</li> <li>■ Specific volume</li> <li>■ Corrected volume flow</li> <li>■ Steam quality</li> <li>■ Degrees of superheat</li> <li>■ Volume flow</li> </ul>	
	<b>Measured variable status [from the factory] <sup>1)</sup></b>			
	Quality			Uncertain
	Quality substatus			Process related
	Coding (hex)			0x78 to 0x7B
	Status signal			S
	Diagnostic behavior			Warning

1) Diagnostic behavior can be changed. This causes the overall status of the measured variable to change.

Diagnostic information		Remedy instructions	Influenced measured variables	
No.	Short text			
841	Flow velocity too high	Reduce flow velocity	<ul style="list-style-type: none"> <li>■ Calculated saturated steam pressure</li> <li>■ Density</li> <li>■ Energy flow</li> <li>■ Flow velocity</li> <li>■ Heat flow difference</li> <li>■ Low flow cut off</li> <li>■ Mass flow</li> <li>■ Total mass flow</li> <li>■ Switch output status</li> <li>■ Pressure</li> <li>■ Reynolds number</li> <li>■ Specific volume</li> <li>■ Corrected volume flow</li> <li>■ Steam quality</li> <li>■ Degrees of superheat</li> <li>■ Volume flow</li> </ul>	
	<b>Measured variable status [from the factory] <sup>1)</sup></b>			
	Quality			Uncertain
	Quality substatus			Process related
	Coding (hex)			0x78 to 0x7B
	Status signal			S
	Diagnostic behavior			Warning

1) Diagnostic behavior can be changed. This causes the overall status of the measured variable to change.

Diagnostic information		Remedy instructions	Influenced measured variables	
No.	Short text			
842	Process limit	Low flow cut off active! 1. Check low flow cut off configuration	<ul style="list-style-type: none"> <li>▪ Calculated saturated steam pressure</li> <li>▪ Density</li> <li>▪ Energy flow</li> <li>▪ Flow velocity</li> <li>▪ Heat flow difference</li> <li>▪ Low flow cut off</li> <li>▪ Mass flow</li> <li>▪ Total mass flow</li> <li>▪ Switch output status</li> <li>▪ Pressure</li> <li>▪ Reynolds number</li> <li>▪ Specific volume</li> <li>▪ Corrected volume flow</li> <li>▪ Steam quality</li> <li>▪ Degrees of superheat</li> <li>▪ Temperature</li> <li>▪ Volume flow</li> </ul>	
	<b>Measured variable status</b>			
	Quality			Good
	Quality substatus			Ok
	Coding (hex)			0x80 to 0x83
	Status signal			S
	Diagnostic behavior			Warning

Diagnostic information		Remedy instructions	Influenced measured variables	
No.	Short text			
844	Sensor range exceeded	Reduce flow velocity	<ul style="list-style-type: none"> <li>▪ Calculated saturated steam pressure</li> <li>▪ Density</li> <li>▪ Energy flow</li> <li>▪ Flow velocity</li> <li>▪ Heat flow difference</li> <li>▪ Low flow cut off</li> <li>▪ Mass flow</li> <li>▪ Total mass flow</li> <li>▪ Switch output status</li> <li>▪ Pressure</li> <li>▪ Reynolds number</li> <li>▪ Specific volume</li> <li>▪ Corrected volume flow</li> <li>▪ Steam quality</li> <li>▪ Degrees of superheat</li> <li>▪ Volume flow</li> </ul>	
	<b>Measured variable status [from the factory] <sup>1)</sup></b>			
	Quality			Uncertain
	Quality substatus			Process related
	Coding (hex)			0x78 to 0x7B
	Status signal			S
	Diagnostic behavior			Warning

1) Diagnostic behavior can be changed. This causes the overall status of the measured variable to change.

Diagnostic information		Remedy instructions	Influenced measured variables	
No.	Short text			
870	Measuring inaccuracy increased	1. Check process 2. Increase flow volume	<ul style="list-style-type: none"> <li>■ Calculated saturated steam pressure</li> <li>■ Density</li> <li>■ Energy flow</li> <li>■ Flow velocity</li> <li>■ Heat flow difference</li> <li>■ Low flow cut off</li> <li>■ Mass flow</li> <li>■ Total mass flow</li> <li>■ Switch output status</li> <li>■ Pressure</li> <li>■ Reynolds number</li> <li>■ Specific volume</li> <li>■ Corrected volume flow</li> <li>■ Steam quality</li> <li>■ Degrees of superheat</li> <li>■ Volume flow</li> </ul>	
	<b>Measured variable status [from the factory] <sup>1)</sup></b>			
	Quality			Uncertain
	Quality substatus			Process related
	Coding (hex)			0x78 to 0x7B
	Status signal			S
	Diagnostic behavior			Warning

1) Diagnostic behavior can be changed. This causes the overall status of the measured variable to change.

Diagnostic information		Remedy instructions	Influenced measured variables	
No.	Short text			
871	Near steam saturation limit	Check process conditions	<ul style="list-style-type: none"> <li>■ Calculated saturated steam pressure</li> <li>■ Density</li> <li>■ Energy flow</li> <li>■ Heat flow difference</li> <li>■ Low flow cut off</li> <li>■ Mass flow</li> <li>■ Total mass flow</li> <li>■ Switch output status</li> <li>■ Pressure</li> <li>■ Reynolds number</li> <li>■ Specific volume</li> <li>■ Corrected volume flow</li> <li>■ Steam quality</li> <li>■ Degrees of superheat</li> </ul>	
	<b>Measured variable status [from the factory] <sup>1)</sup></b>			
	Quality			Uncertain
	Quality substatus			Process related
	Coding (hex)			0x78 to 0x7B
	Status signal			S
	Diagnostic behavior			Warning

1) Diagnostic behavior can be changed. This causes the overall status of the measured variable to change.

Diagnostic information		Remedy instructions	Influenced measured variables	
No.	Short text			
872	Wet steam detected	1. Check process 2. Check plant	<ul style="list-style-type: none"> <li>■ Energy flow</li> <li>■ Heat flow difference</li> <li>■ Low flow cut off</li> <li>■ Total mass flow</li> <li>■ Switch output status</li> <li>■ Corrected volume flow</li> <li>■ Steam quality</li> </ul>	
	<b>Measured variable status [from the factory] <sup>1)</sup></b>			
	Quality			Uncertain
	Quality substatus			Process related
	Coding (hex)			0x78 to 0x7B
	Status signal			S
	Diagnostic behavior			Warning

1) Diagnostic behavior can be changed. This causes the overall status of the measured variable to change.

Diagnostic information		Remedy instructions	Influenced measured variables	
No.	Short text			
873	Water detected	Check process (water in piping)	<ul style="list-style-type: none"> <li>▪ Calculated saturated steam pressure</li> <li>▪ Density</li> <li>▪ Energy flow</li> <li>▪ Heat flow difference</li> <li>▪ Low flow cut off</li> <li>▪ Mass flow</li> <li>▪ Total mass flow</li> <li>▪ Switch output status</li> <li>▪ Pressure</li> <li>▪ Reynolds number</li> <li>▪ Specific volume</li> <li>▪ Corrected volume flow</li> <li>▪ Steam quality</li> <li>▪ Degrees of superheat</li> </ul>	
	<b>Measured variable status [from the factory] <sup>1)</sup></b>			
	Quality			Uncertain
	Quality substatus			Process related
	Coding (hex)			0x78 to 0x7B
	Status signal			S
	Diagnostic behavior			Warning

1) Diagnostic behavior can be changed. This causes the overall status of the measured variable to change.

Diagnostic information		Remedy instructions	Influenced measured variables	
No.	Short text			
874	X% spec invalid	<ol style="list-style-type: none"> <li>1. Check pressure, temperature</li> <li>2. Check flow velocity</li> <li>3. Check for flow fluctuation</li> </ol>	<ul style="list-style-type: none"> <li>▪ Calculated saturated steam pressure</li> <li>▪ Density</li> <li>▪ Energy flow</li> <li>▪ Heat flow difference</li> <li>▪ Low flow cut off</li> <li>▪ Mass flow</li> <li>▪ Total mass flow</li> <li>▪ Switch output status</li> <li>▪ Pressure</li> <li>▪ Reynolds number</li> <li>▪ Specific volume</li> <li>▪ Corrected volume flow</li> <li>▪ Steam quality</li> <li>▪ Degrees of superheat</li> </ul>	
	<b>Measured variable status</b>			
	Quality			Uncertain
	Quality substatus			Process related
	Coding (hex)			0x78 to 0x7B
	Status signal			S
	Diagnostic behavior			Warning

Diagnostic information		Remedy instructions	Influenced measured variables	
No.	Short text			
882	Input signal	<ol style="list-style-type: none"> <li>1. Check input configuration</li> <li>2. Check external device or process conditions</li> </ol>	<ul style="list-style-type: none"> <li>▪ Calculated saturated steam pressure</li> <li>▪ Density</li> <li>▪ Energy flow</li> <li>▪ Flow velocity</li> <li>▪ Heat flow difference</li> <li>▪ Low flow cut off</li> <li>▪ Mass flow</li> <li>▪ Total mass flow</li> <li>▪ Switch output status</li> <li>▪ Pressure</li> <li>▪ Reynolds number</li> <li>▪ Specific volume</li> <li>▪ Corrected volume flow</li> <li>▪ Steam quality</li> <li>▪ Degrees of superheat</li> <li>▪ Temperature</li> <li>▪ Volume flow</li> </ul>	
	<b>Measured variable status</b>			
	Quality			Bad
	Quality substatus			Maintenance alarm
	Coding (hex)			0x24 to 0x27
	Status signal			F
	Diagnostic behavior			Alarm



Diagnostic information		Remedy instructions	Influenced measured variables	
No.	Short text			
945	Sensor range exceeded	Check immediately process conditions (pressure-temperature rating)	<ul style="list-style-type: none"> <li>■ Calculated saturated steam pressure</li> <li>■ Density</li> <li>■ Energy flow</li> <li>■ Flow velocity</li> <li>■ Heat flow difference</li> <li>■ Low flow cut off</li> <li>■ Mass flow</li> <li>■ Total mass flow</li> <li>■ Switch output status</li> <li>■ Pressure</li> <li>■ Reynolds number</li> <li>■ Specific volume</li> <li>■ Corrected volume flow</li> <li>■ Steam quality</li> <li>■ Degrees of superheat</li> <li>■ Volume flow</li> </ul>	
	<b>Measured variable status [from the factory] <sup>1)</sup></b>			
	Quality			Uncertain
	Quality substatus			Process related
	Coding (hex)			0x78 to 0x7B
	Status signal			S
	Diagnostic behavior			Warning

1) Diagnostic behavior can be changed. This causes the overall status of the measured variable to change.

Diagnostic information		Remedy instructions	Influenced measured variables	
No.	Short text			
946	Vibration detected	Check installation	<ul style="list-style-type: none"> <li>■ Calculated saturated steam pressure</li> <li>■ Density</li> <li>■ Energy flow</li> <li>■ Flow velocity</li> <li>■ Heat flow difference</li> <li>■ Low flow cut off</li> <li>■ Mass flow</li> <li>■ Total mass flow</li> <li>■ Switch output status</li> <li>■ Pressure</li> <li>■ Reynolds number</li> <li>■ Specific volume</li> <li>■ Corrected volume flow</li> <li>■ Steam quality</li> <li>■ Degrees of superheat</li> <li>■ Volume flow</li> </ul>	
	<b>Measured variable status</b>			
	Quality			Uncertain
	Quality substatus			Process related
	Coding (hex)			0x78 to 0x7B
	Status signal			S
	Diagnostic behavior			Warning

Diagnostic information		Remedy instructions	Influenced measured variables	
No.	Short text			
947	Vibration exceeded	Check installation	<ul style="list-style-type: none"> <li>■ Calculated saturated steam pressure</li> <li>■ Density</li> <li>■ Energy flow</li> <li>■ Flow velocity</li> <li>■ Heat flow difference</li> <li>■ Low flow cut off</li> <li>■ Mass flow</li> <li>■ Total mass flow</li> <li>■ Switch output status</li> <li>■ Pressure</li> <li>■ Reynolds number</li> <li>■ Specific volume</li> <li>■ Corrected volume flow</li> <li>■ Steam quality</li> <li>■ Degrees of superheat</li> <li>■ Volume flow</li> </ul>	
	<b>Measured variable status [from the factory] <sup>1)</sup></b>			
	Quality			Uncertain
	Quality substatus			Process related
	Coding (hex)			0x78 to 0x7B
	Status signal			S
	Diagnostic behavior			Alarm



1) Diagnostic behavior can be changed. This causes the overall status of the measured variable to change.



Diagnostic information		Remedy instructions	Influenced measured variables	
No.	Short text			
972	Degrees of superheat limit exceeded	1. Controll process conditions 2. Install pressure transmitter or enter correct fixed pressure value	<ul style="list-style-type: none"> <li>■ Calculated saturated steam pressure</li> <li>■ Density</li> <li>■ Energy flow</li> <li>■ Heat flow difference</li> <li>■ Low flow cut off</li> <li>■ Mass flow</li> <li>■ Total mass flow</li> <li>■ Switch output status</li> <li>■ Reynolds number</li> <li>■ Corrected volume flow</li> <li>■ Steam quality</li> </ul>	
	<b>Measured variable status [from the factory] <sup>1)</sup></b>			
	Quality			Uncertain
	Quality substatus			Process related
	Coding (hex)			0x78 to 0x7B
	Status signal			S
	Diagnostic behavior			Warning

1) Diagnostic behavior can be changed. This causes the overall status of the measured variable to change.

## 12.6 Pending diagnostic events

The **Diagnostics** menu allows the user to view the current diagnostic event and the previous diagnostic event separately.

-  To call up the measures to rectify a diagnostic event:
  - Via local display →  139
  - Via "FieldCare" operating tool →  140

-  Other pending diagnostic events can be displayed in the **Diagnostic list** submenu →  171

**Navigation**  
 "Diagnostics" menu

### Structure of the submenu

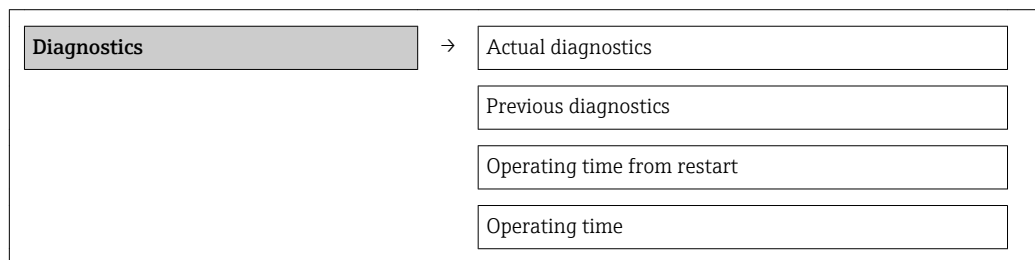

### Parameter overview with brief description

Parameter	Prerequisite	Description	User interface
Actual diagnostics	A diagnostic event has occurred.	Shows the current occurred diagnostic event along with its diagnostic information.   If two or more messages occur simultaneously, the message with the highest priority is shown on the display.	Symbol for diagnostic behavior, diagnostic code and short message.
Previous diagnostics	Two diagnostic events have already occurred.	Shows the diagnostic event that occurred prior to the current diagnostic event along with its diagnostic information.	Symbol for diagnostic behavior, diagnostic code and short message.

Parameter	Prerequisite	Description	User interface
Operating time from restart	–	Shows the time the device has been in operation since the last device restart.	Days (d), hours (h), minutes (m) and seconds (s)
Operating time	–	Indicates how long the device has been in operation.	Days (d), hours (h), minutes (m) and seconds (s)

## 12.7 Diagnostic list

In the **Diagnostic list** submenu, up to 5 currently pending diagnostic events can be displayed along with the related diagnostic information. If more than 5 diagnostic events are pending, the events with the highest priority are shown on the display.

### Navigation path

**Diagnostics** menu → **Diagnostic list** submenu

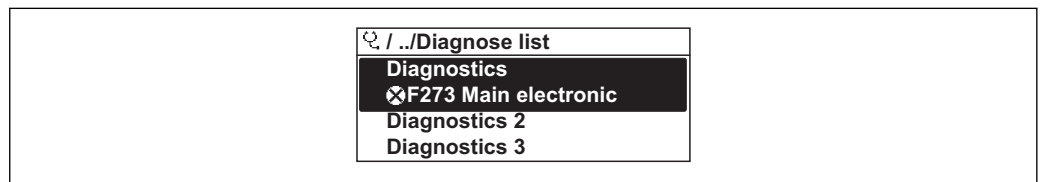

33 Taking the example of the local display

**i** To call up the measures to rectify a diagnostic event:

- Via local display → 139
- Via "FieldCare" operating tool → 140

## 12.8 Event logbook

### 12.8.1 Event history

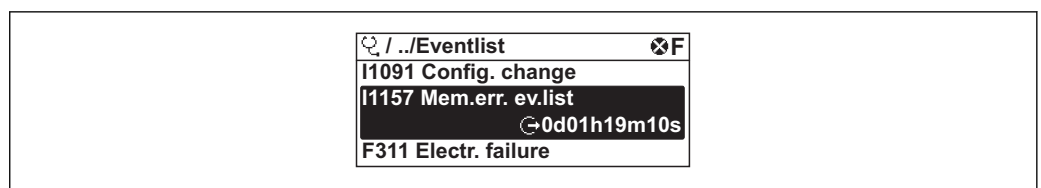

34 Taking the example of the local display

**i** To call up the measures to rectify a diagnostic event:

- Via local display → 139
- Via "FieldCare" operating tool → 140

**i** For filtering the displayed event messages → 171

### 12.8.2 Filtering the event logbook

Using the **Filter options** parameter, you can define which category of event messages is displayed in the **Events list** submenu.

### Navigation path

"Diagnostics" menu → Event logbook → Filter options

**Filter categories**

- All
- Failure (F)
- Function check (C)
- Out of specification (S)
- Maintenance required (M)
- Information (I)

**12.8.3 Overview of information events**

Unlike a diagnostic event, an information event is displayed in the event logbook only and not in the diagnostic list.

Info number	Info name
I1000	----- (Device ok)
I1079	Sensor changed
I1089	Power on
I1090	Configuration reset
I1091	Configuration changed
I1092	Trend data deleted
I1110	Write protection switch changed
I1137	Electronic changed
I1151	History reset
I1154	Reset terminal voltage min/max
I1155	Reset electronic temperature
I1156	Memory error trend
I1157	Memory error event list
I1185	Display backup done
I1186	Restore via display done
I1187	Settings downloaded with display
I1188	Display data cleared
I1189	Backup compared
I1227	Sensor emergency mode activated
I1228	Sensor emergency mode failed
I1256	Display: access status changed
I1264	Safety sequence aborted
I1335	Firmware changed
I1397	Fieldbus: access status changed
I1398	CDI: access status changed
I1444	Device verification passed
I1445	Device verification failed
I1459	Failed: I/O module verification
I1461	Failed: Sensor verification
I1512	Download started
I1513	Download finished
I1514	Upload started
I1515	Upload finished

Info number	Info name
I1552	Failed: Main electronic verification
I1553	Failed: Pre-amplifier verification

## 12.9 Resetting the measuring device

Using the **Device reset** parameter it is possible to reset the entire device configuration or some of the configuration to a defined state.

### Navigation

"Setup" menu → Advanced setup → Administration → Device reset

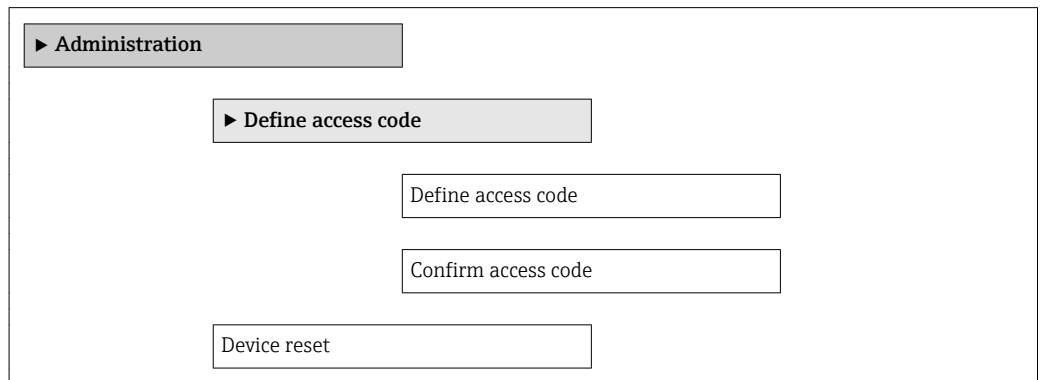

### Parameter overview with brief description

Parameter	Description	Selection	Factory setting
Device reset	Reset the device configuration - either entirely or in part - to a defined state.	<ul style="list-style-type: none"> <li>■ Cancel</li> <li>■ To fieldbus defaults *</li> <li>■ To factory defaults</li> <li>■ To delivery settings</li> <li>■ Restart device</li> </ul>	Cancel

\* Visibility depends on communication

### 12.9.1 Function scope of the "Device reset" parameter

Options	Description
Cancel	No action is executed and the user exits the parameter.
To delivery settings	Every parameter for which a customer-specific default setting was ordered is reset to this customer-specific value. All other parameters are reset to the factory setting.
Restart device	The restart resets every parameter whose data are in the volatile memory (RAM) to the factory setting (e.g. measured value data). The device configuration remains unchanged.
History reset	Every parameter is reset to the factory setting.

## 12.10 Device information

The **Device information** submenu contains all the parameters that display different information for identifying the device.

**Navigation**

"Diagnostics" menu → Device information

▶ **Device information**

Device tag

Serial number

Firmware version

Device name

Order code



Extended order code 1



Extended order code 2

Extended order code 3

ENP version

**Parameter overview with brief description**

Parameter	Description	User interface	Factory setting
Device tag	Display the name for the measuring point.	Max. 32 characters such as letters, numbers or special characters (e.g. @, %, /)	Prowirl 200 PA
Serial number	Shows the serial number of the measuring device.	A maximum of 11-digit character string comprising letters and numbers.	–
Firmware version	Shows the device firmware version installed.	Character string in the format xx.yy	01.01
Device name	Shows the name of the transmitter.  The name can be found on the nameplate of the transmitter.	Prowirl	–
Order code	Shows the device order code.  The order code can be found on the nameplate of the sensor and transmitter in the "Order code" field.	Character string composed of letters, numbers and certain punctuation marks (e.g. /).	–
Extended order code 1	Shows the 1st part of the extended order code.  The extended order code can also be found on the nameplate of the sensor and transmitter in the "Ext. ord. cd." field.	Character string	–

Parameter	Description	User interface	Factory setting
Extended order code 2	Shows the 2nd part of the extended order code.  The extended order code can also be found on the nameplate of the sensor and transmitter in the "Ext. ord. cd." field.	Character string	–
Extended order code 3	Shows the 3rd part of the extended order code.  The extended order code can also be found on the nameplate of the sensor and transmitter in the "Ext. ord. cd." field.	Character string	–
ENP version	Shows the version of the electronic nameplate (ENP).	Character string	2.02.00
PROFIBUS ident number	Displays the PROFIBUS identification number.	0 to FFFF	0x1564
Status PROFIBUS Master Config	Displays the status of the PROFIBUS Master configuration.	<ul style="list-style-type: none"> <li>■ Active</li> <li>■ Not active</li> </ul>	Not active

## 12.11 Firmware history

Release date	Firmware version	Order code for "Firmware version"	Firmware changes	Documentation type	Documentation
10.2014	01.01.00	Option 73	<ul style="list-style-type: none"> <li>▪ No need to restart device after parameter download</li> <li>▪ Additional process variables:               <ul style="list-style-type: none"> <li>- Pressure</li> <li>- Degree of overheating</li> <li>- Specific volume</li> </ul> </li> <li>▪ Process variables interconnectable with local display and data logger (trend)</li> <li>▪ Additional AI channels:               <ul style="list-style-type: none"> <li>- Pressure</li> <li>- Degree of overheating</li> <li>- Specific volume</li> <li>- Density</li> <li>- Reynolds number</li> </ul> </li> <li>▪ Verification progress is displayed (0-100%)</li> <li>▪ New Wet Steam Measurement application package</li> <li>▪ Operation in steam simplified</li> <li>▪ More robust signal processing in event of low flow rates in wet steam</li> </ul>	Operating Instructions	BA01220D/06/EN/01.14
10.2013	01.00.00	Option 77	Original firmware	Operating Instructions	BA01220D/06/EN/01.13

 Flashing the firmware to the current version or to the previous version is possible via the service interface (CDI) .

 For the compatibility of the firmware version with the previous version, the installed device description files and operating tools, observe the information about the device in the "Manufacturer's information" document.

 The manufacturer's information is available:

- In the Downloads area of the Endress+Hauser web site: [www.endress.com](http://www.endress.com) → Downloads
- Specify the following details:
  - Text search: Manufacturer's information
  - Media type: Documentation – Technical Documentation



## 13 Maintenance

### 13.1 Maintenance tasks

No special maintenance work is required.

#### 13.1.1 Exterior cleaning

When cleaning the exterior of measuring devices, always use cleaning agents that do not attack the surface of the housing or the seals.

#### 13.1.2 Interior cleaning

##### NOTICE

**The use of unsuitable equipment or cleaning liquids can damage the transducer.**

- ▶ Do not use pigs to clean the pipe.

#### 13.1.3 Replacing seals

##### Replacing sensor seals

##### NOTICE

**Under normal circumstances, wetted seals must not be replaced.**

Replacement is necessary only in special circumstances, for example if aggressive or corrosive fluids are incompatible with the seal material.

- ▶ The time span between the individual replacement procedures depends on the fluid properties.
- ▶ Only Endress+Hauser sensor seals may be used: replacement seals

##### Replacing housing seals

The housing seals must be clean and undamaged when inserted into their grooves. Dry, clean or replace the seals if necessary.

##### NOTICE

**When the measuring device is used in a dusty atmosphere:**

- ▶ only use the associated Endress+Hauser housing seals.

### 13.2 Inspection ports

According to the requirements of the ERCB (Canada), in certain applications the owner-operator of a plant is required to maintain a servicing interval of 12 months.

With its unique inspection concept for Prowirl C 200 and the associated inspection kit, Endress+Hauser is offering a solution that enables maintenance and visual inspection to be performed on the installed device.



For detailed information on the inspection ports and the inspection kit:

- Special Documentation for the device →  208
- Installation Instructions EA01058D

### 13.3 Measuring and test equipment

Endress+Hauser offers a wide variety of measuring and test equipment, such as W@M or device tests.



Your Endress+Hauser Sales Center can provide detailed information on the services.



For a list of some of the measuring and test equipment, refer to the "Accessories" chapter of the "Technical Information" document for the device.

### 13.4 Endress+Hauser services

Endress+Hauser offers a wide variety of services for maintenance such as recalibration, maintenance service or device tests.



Your Endress+Hauser Sales Center can provide detailed information on the services.

## 14 Repair

### 14.1 General notes

#### Repair and conversion concept

The Endress+Hauser repair and conversion concept provides for the following:

- The measuring devices have a modular design.
- Spare parts are grouped into logical kits with the associated Installation Instructions.
- Repairs are carried out by Endress+Hauser Service or by correspondingly trained customers.
- Certified devices can be converted into other certified devices by Endress+Hauser Service or at the factory only.

#### Notes for repair and conversion

For repair and modification of a measuring device, observe the following notes:

- Use only original Endress+Hauser spare parts.
- Carry out the repair according to the Installation Instructions.
- Observe the applicable standards, federal/national regulations, Ex documentation (XA) and certificates.
- Document every repair and each conversion and enter them into the *W@M* life cycle management database.

### 14.2 Spare parts

Some interchangeable measuring device components are listed on an overview sign in the connection compartment cover.

The spare part overview sign contains the following information:

- A list of the most important spare parts for the measuring device, including their ordering information.
- The URL for the *W@M Device Viewer* ([www.endress.com/deviceviewer](http://www.endress.com/deviceviewer)):  
All the spare parts for the measuring device, along with the order code, are listed here and can be ordered. If available, users can also download the associated Installation Instructions.

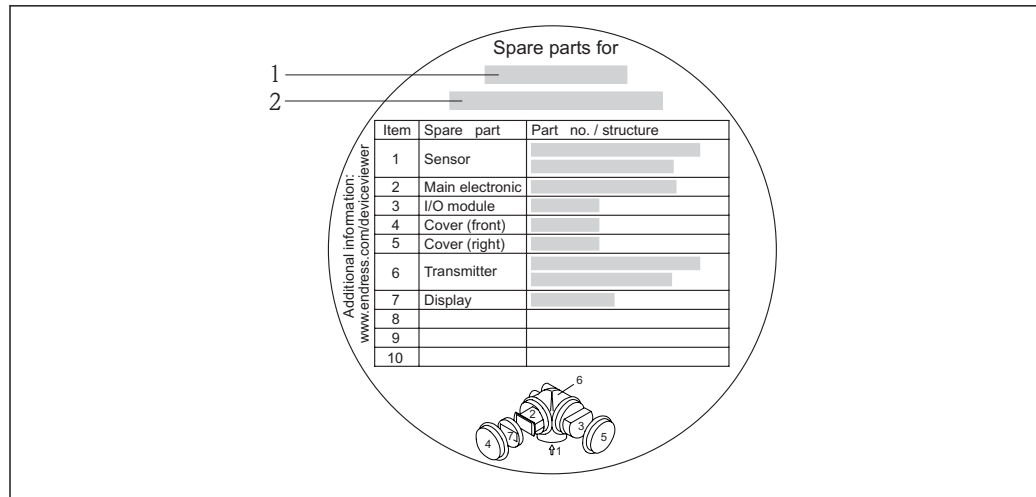

35 Example for "Spare part overview sign" in connection compartment cover

- 1 Measuring device name
- 2 Measuring device serial number

- Measuring device serial number:
- Is located on the device nameplate and the spare part overview sign.
  - Can be read out via the **Serial number** parameter in the **Device information** submenu .

## 14.3 Endress+Hauser services

Endress+Hauser offers a wide range of services.

- Your Endress+Hauser Sales Center can provide detailed information on the services.

## 14.4 Return

The measuring device must be returned if it is need of repair or a factory calibration, or if the wrong measuring device has been delivered or ordered. Legal specifications require Endress+Hauser, as an ISO-certified company, to follow certain procedures when handling products that are in contact with the medium.

To ensure safe, swift and professional device returns, please refer to the procedure and conditions for returning devices provided on the Endress+Hauser website at <http://www.endress.com/support/return-material>

## 14.5 Disposal

### 14.5.1 Removing the measuring device

1. Switch off the device.
2. **WARNING**  
**Danger to persons from process conditions.**
  - ▶ Beware of hazardous process conditions such as pressure in the measuring device, high temperatures or aggressive fluids.

Carry out the mounting and connection steps from the chapters "Mounting the measuring device" and "Connecting the measuring device" in the logically reverse sequence. Observe the safety instructions.

## 14.5.2 Disposing of the measuring device

### WARNING

**Danger to personnel and environment from fluids that are hazardous to health.**

- ▶ Ensure that the measuring device and all cavities are free of fluid residues that are hazardous to health or the environment, e.g. substances that have permeated into crevices or diffused through plastic.

Observe the following notes during disposal:





- Observe valid federal/national regulations.
- Ensure proper separation and reuse of the device components.



## 15 Accessories

Various accessories, which can be ordered with the device or subsequently from Endress+Hauser, are available for the device. Detailed information on the order code in question is available from your local Endress+Hauser sales center or on the product page of the Endress+Hauser website: [www.endress.com](http://www.endress.com).

### 15.1 Device-specific accessories

#### 15.1.1 For the transmitter

Accessories	Description
Prowirl 200 transmitter	<p>Transmitter for replacement or storage. Use the order code to define the following specifications:</p> <ul style="list-style-type: none"> <li>▪ Approvals</li> <li>▪ Output</li> <li>▪ Display / operation</li> <li>▪ Housing</li> <li>▪ Software</li> </ul> <p> For details, see Installation Instructions EA01056D</p>
Remote display FHX50	<p>FHX50 housing for accommodating a display module →  205.</p> <ul style="list-style-type: none"> <li>▪ FHX50 housing suitable for: <ul style="list-style-type: none"> <li>– SD02 display module (push buttons)</li> <li>– SD03 display module (touch control)</li> </ul> </li> <li>▪ Housing material: <ul style="list-style-type: none"> <li>– Plastic PBT</li> <li>– Stainless steel CF-3M (316L, 1.4404)</li> </ul> </li> <li>▪ Length of connecting cable: up to max. 60 m (196 ft) (cable lengths available for order: 5 m (16 ft), 10 m (32 ft), 20 m (65 ft), 30 m (98 ft))</li> </ul> <p>The measuring device can be ordered with the FHX50 housing and a display module. The following options must be selected in the separate order codes:</p> <ul style="list-style-type: none"> <li>▪ Order code for measuring device, feature 030: Option L or M "Prepared for FHX50 display"</li> <li>▪ Order code for FHX50 housing, feature 050 (device version): Option A "Prepared for FHX50 display"</li> <li>▪ Order code for FHX50 housing, depends on the desired display module in feature 020 (display, operation): <ul style="list-style-type: none"> <li>– Option C: for an SD02 display module (push buttons)</li> <li>– Option E: for an SD03 display module (touch control)</li> </ul> </li> </ul> <p>The FHX50 housing can also be ordered as a retrofit kit. The measuring device display module is used in the FHX50 housing. The following options must be selected in the order code for the FHX50 housing:</p> <ul style="list-style-type: none"> <li>▪ Feature 050 (measuring device version): option B "Not prepared for FHX50 display"</li> <li>▪ Feature 020 (display, operation): option A "None, existing displayed used"</li> </ul> <p> For details, see Special Documentation SD01007F</p> <p>(Order number: FHX50)</p>
Overvoltage protection for 2-wire devices	<p>Ideally, the overvoltage protection module should be ordered directly with the device. See product structure, characteristic 610 "Accessory mounted", option NA "Overvoltage protection". Separate order necessary only if retrofitting.</p> <ul style="list-style-type: none"> <li>▪ OVP10: For 1-channel devices (characteristic 020, option A):</li> <li>▪ OVP20: For 2-channel devices (characteristic 020, options B, C, E or G)</li> </ul> <p> For details, see Special Documentation SD01090F.</p>



Weather protection cover	<p>Is used to protect the measuring device from the effects of the weather: e.g. rainwater, excess heating from direct sunlight or extreme cold in winter.</p> <p> For details, see Special Documentation SD00333F</p>
Connecting cable for remote version	<ul style="list-style-type: none"> <li>■ Connecting cable available in various lengths: <ul style="list-style-type: none"> <li>- 5 m (16 ft)</li> <li>- 10 m (32 ft)</li> <li>- 20 m (65 ft)</li> <li>- 30 m (98 ft)</li> </ul> </li> <li>■ Reinforced cables available on request.</li> </ul> <p> Standard length: 5 m (16 ft) Is always supplied if no other cable length has been ordered.</p>
Post mounting kit	<p>Post mounting kit for transmitter.</p> <p> The post mounting kit can only be ordered together with a transmitter.</p> <p>(Order number: DK8WM-B)</p>

### 15.1.2 For the sensor



Accessories	Description
Inspection kit	<p>The inspection kit comprises:</p> <ul style="list-style-type: none"> <li>■ 2 inspection centering sleeves</li> <li>■ 8 screws</li> <li>■ 2 inspection seals</li> <li>■ 2 inspection covers</li> </ul> <p> For details, see Installation Instructions EA01058D</p> <p>(Order number: 71223000)</p>

## 15.2 Service-specific accessories

Accessories	Description
Applicator	<p>Software for selecting and sizing Endress+Hauser measuring devices:</p> <ul style="list-style-type: none"> <li>■ Calculation of all the necessary data for identifying the optimum flowmeter: e.g. nominal diameter, pressure loss, accuracy or process connections.</li> <li>■ Graphic illustration of the calculation results</li> </ul> <p>Administration, documentation and access to all project-related data and parameters throughout the entire life cycle of a project.</p> <p>Applicator is available:</p> <ul style="list-style-type: none"> <li>■ Via the Internet: <a href="https://wapps.endress.com/applicator">https://wapps.endress.com/applicator</a></li> <li>■ On CD-ROM for local PC installation.</li> </ul>
W@M	<p>Life cycle management for your plant</p> <p>W@M supports you with a wide range of software applications over the entire process: from planning and procurement, to the installation, commissioning and operation of the measuring devices. All the relevant device information, such as the device status, spare parts and device-specific documentation, is available for every device over the entire life cycle.</p> <p>The application already contains the data of your Endress+Hauser device. Endress+Hauser also takes care of maintaining and updating the data records.</p> <p>W@M is available:</p> <ul style="list-style-type: none"> <li>■ Via the Internet: <a href="http://www.endress.com/lifecyclemanagement">www.endress.com/lifecyclemanagement</a></li> <li>■ On CD-ROM for local PC installation.</li> </ul>

FieldCare	<p>FDT-based plant asset management tool from Endress+Hauser. It can configure all smart field units in your system and helps you manage them. By using the status information, it is also a simple but effective way of checking their status and condition.</p> <p> For details, see Operating Instructions BA00027S and BA00059S</p>
DeviceCare	<p>Tool for connecting and configuring Endress+Hauser field devices.</p> <p> For details, see Innovation brochure IN01047S</p>

### 15.3 System components

Accessories	Description
Memograph M graphic display recorder	<p>The Memograph M graphic display recorder provides information on all relevant measured variables. Measured values are recorded correctly, limit values are monitored and measuring points analyzed. The data are stored in the 256 MB internal memory and also on a SD card or USB stick.</p> <p> For details, see "Technical Information" TI00133R and Operating Instructions BA00247R</p>
Cerabar M	<p>The pressure transmitter for measuring the absolute and gauge pressure of gases, steam and liquids. It can be used to read in the operating pressure value.</p> <p> For details, see "Technical Information" TI00426P, TI00436P and Operating Instructions BA00200P, BA00382P</p>
Cerabar S	<p>The pressure transmitter for measuring the absolute and gauge pressure of gases, steam and liquids. It can be used to read in the operating pressure value.</p> <p> For details, see "Technical Information" TI00383P and Operating Instructions BA00271P</p>



## 16 Technical data

### 16.1 Application

Depending on the version ordered, the measuring device can also measure potentially explosive, flammable, poisonous and oxidizing media.

To ensure that the device remains in proper operating condition for its service life, use the measuring device only for media against which the process-wetted materials are adequately resistant.

### 16.2 Function and system design

---

Measuring principle	Vortex meters work on the principle of the <i>Karman vortex street</i> .
---------------------	--

---

Measuring system	<p>The device consists of a transmitter and a sensor.</p> <p>Two device versions are available:</p> <ul style="list-style-type: none"> <li>■ Compact version – transmitter and sensor form a mechanical unit.</li> <li>■ Remote version - transmitter and sensor are mounted in separate locations.</li> </ul> <p>For information on the structure of the device →  11</p>
------------------	---

### 16.3 Input

---

Measured variable	<p><b>Direct measured variables</b></p> <p>Order code for "Sensor version": Option 4 "Volume flow, Alloy 718": Volume flow</p> <p>Order code for "Sensor version": Option 6 "Mass flow, Alloy 718": – Volume flow – Temperature</p> <p><b>Calculated measured variables</b></p> <p>Order code for "Sensor version": Option 4 "Volume flow, Alloy 718": – In the case of constant process conditions: Mass flow <sup>1)</sup> or Corrected volume flow – The totalized values for Volume flow, Mass flow, or Corrected volume flow</p> <p>Order code for "Sensor version": Option 6 "Mass flow, Alloy 718": – Corrected volume flow – Mass flow – Calculated saturated steam pressure – Energy flow – Heat flow difference – Specific volume – Degrees of superheat</p>
-------------------	--

---

1) A fixed density must be entered for calculating the mass flow (Setup menu → Advanced setup submenu → External compensation submenu → Fixed density parameter).

*Calculation of the measured variables*

The meter electronics system of the Prowirl 200 unit with the order code "Sensor version", option 3 "Mass flow, Alloy 718" has a flow computer. This computer can calculate the following secondary measured variables directly from the primary measured variables recorded using the pressure value (entered or external) and/or temperature value (measured or entered).

*Mass flow and corrected volume flow*

Medium	Fluid	Standards	Explanation	
Steam <sup>1)</sup>	-	IAPWS-IF97/ ASME	If integrated temperature measurement is provided and the process pressure is fixed, or if the pressure is read in via PROFIBUS PA	
Gas	Single gas	NEL40	If the process pressure is fixed, or if the pressure is read in via PROFIBUS PA	
	Gas mixture	NEL40		
	Air	NEL40		
	Natural gas		ISO 12213-2	Contains AGA8-DC92 If the process pressure is fixed, or if the pressure is read in via PROFIBUS PA
			AGA NX-19	If the process pressure is fixed, or if the pressure is read in via PROFIBUS PA
			ISO 12213-3	Contains SGERG-88, AGA8 Gross Method 1 If the process pressure is fixed, or if the pressure is read in via PROFIBUS PA
Other gases	Linear equation	Ideal gases If the process pressure is fixed, or if the pressure is read in via PROFIBUS PA		
Liquids	Water	IAPWS-IF97/ ASME		
	Liquefied gas	Tables	Propane and butane mixture	
	Other liquid	Linear equation	Ideal liquids	

1) The Prowirl 200 is able to calculate the volume flow, and other measured variables derived from the volume flow, across all steam types with full compensation using the pressure and temperature. For information on setting the device behavior, see the "Perform external compensation" section → 101

*Mass flow calculation*

Volume flow × operating density

- Operating density for saturated steam, water and other liquids: depends on the temperature
- Operating density for superheated steam and all other gases: depends on the temperature and process pressure

*Corrected volume flow calculation*

(Volume flow × operating density)/reference density

- Operating density for water and other liquids: depends on the temperature
- Operating density for all other gases: depends on the temperature and process pressure

*Energy flow*

Medium	Fluid	Standards	Explanation	Heat/energy option
Steam <sup>1)</sup>	–	IAPWS-IF97/ASME	If the process pressure is fixed, or if the pressure is read in via PROFIBUS PA	Heat Gross calorific value <sup>2)</sup> in relation to mass Net calorific value <sup>3)</sup> in relation to mass Gross calorific value <sup>2)</sup> in relation to corrected volume Net calorific value <sup>3)</sup> in relation to corrected volume
Gas	Single gas	ISO 6976	Contains GPA 2172 If the process pressure is fixed, or if the pressure is read in via PROFIBUS PA	
	Gas mixture	ISO 6976	Contains GPA 2172 If the process pressure is fixed, or if the pressure is read in via PROFIBUS PA	
	Air	NEL40	If the process pressure is fixed, or if the pressure is read in via PROFIBUS PA	
	Natural gas	ISO 6976	Contains GPA 2172 If the process pressure is fixed, or if the pressure is read in via PROFIBUS PA	
AGA 5				
Liquids	Water	IAPWS-IF97/ASME		
	Liquefied gas	ISO 6976	Contains GPA 2172	
	Other liquid	Linear equation		



- 1) The Prowirl 200 is able to calculate the volume flow, and other measured variables derived from the volume flow, across all steam types with full compensation using the pressure and temperature. For information on setting the device behavior, see the "Perform external compensation" section →  101
- 2) Gross calorific value: combustion energy + condensation energy of the flue gas (gross calorific value > net calorific value)
- 3) Net calorific value: only combustion energy

*Mass flow and energy flow calculation***NOTICE**

**The process pressure (p) in the process pipe is required to calculate the process variables and the limit values of the measuring range.**

- ▶ In the case of the PROFIBUS PA device, the process pressure can be transmitted from the Profibus master to the measuring device via the AO Block or entered as a fixed value in the **External compensation** submenu (→  101).

Steam is calculated based on the following factors:

- The measuring device calculates the density with full compensation using the pressure and temperature measured variables.
- Assuming superheated steam conditions the measuring device calculates until the saturation point is reached. The diagnostic behavior of the diagnostic message **△S871 Near steam saturation limit** is set to **Off** by default (ex works) →  145. This diagnostic behavior can optionally be redefined as an alarm or a warning →  142. Then the diagnostic message **△S871 Near steam saturation limit** is triggered at 2 K above saturation.
- The smaller of the following two pressure values is always used to calculate the density:
  - The measured pressure which is either entered as the Fixed process pressure (→  77) ≠ 0 bar abs. or read in via PROFIBUS PA
  - The saturated steam pressure which is determined from the saturated steam line (IAPWS-IF97/ASME)
- If the fixed process pressure = 0 bar abs. the measuring device only calculates on the saturated steam curve using temperature compensation.

 For detailed information on performing external compensation: →  101

*Calculated value*

The unit calculates the mass flow, heat flow, energy flow, density and specific enthalpy from the measured volume flow and the measured temperature and/or the pressure based on international standard IAPWS-IF97/ASME.

Formulae for calculation:

- Mass flow:  $m = q \cdot \rho (T, p)$
- Heat quantity:  $E = q \cdot \rho (T, p) \cdot h_D (T, p)$

m = Mass flow

E = Heat quantity

q = Volume flow (measured)

$h_D$  = Specific enthalpy

T = Process temperature (measured)

p = Process pressure

$\rho$  = Density <sup>2)</sup>

*Pre-programmed gases*

*The following gases are pre-programmed in the flow computer:*

Hydrogen <sup>1)</sup>	Helium 4	Neon	Argon
Krypton	Xenon	Nitrogen	Oxygen
Chlorine	Ammonia	Carbon monoxide <sup>1)</sup>	Carbon dioxide
Sulfur dioxide	Hydrogen sulfide <sup>1)</sup>	Hydrogen chloride	Methane <sup>1)</sup>
Ethane <sup>1)</sup>	Propane <sup>1)</sup>	Butane <sup>1)</sup>	Ethylene (ethene) <sup>1)</sup>
Vinyl chloride	Mixtures of up to 8 components of these gases <sup>1)</sup>		

1) The energy flow is calculated as per ISO 6976 (contains GPA 2172) or AGA5 - in relation to the net calorific value or gross calorific value .

2) From steam data as per IAPWS-IF97 (ASME), for the measured temperature and the specified pressure

*Energy flow calculation*

Volume flow  $\times$  operating density  $\times$  specific enthalpy

- Operating density for saturated steam and water: depends on the temperature
- Operating density for superheated steam, natural gas ISO 6976 (contains GPA 2172), natural gas AGA5: depends on the temperature and pressure

*Heat flow difference*

- Between saturated steam upstream from a heat exchanger and condensate downstream from the heat exchanger (second temperature read in via PROFIBUS PA) in accordance with IAPWS-IF97/ASME  $\rightarrow$  23.
- Between warm and cold water (second temperature read in via PROFIBUS PA) in accordance with IAPWS-IF97/ASME.

*Vapor pressure and steam temperature*

The measuring device can perform the following in saturated steam measurements between the feed line and return line of any heating liquid (second temperature read in via PROFIBUS PA and  $C_p$  value entered):

- Calculate the saturation pressure of the steam from the measured temperature and output the value in accordance with IAPWS-IF97/ASME.
- Calculate the saturation temperature of the steam from the specified pressure and output the value in accordance with IAPWS-IF97/ASME.

Measuring range

The measuring range depends on the fluid and nominal diameter.

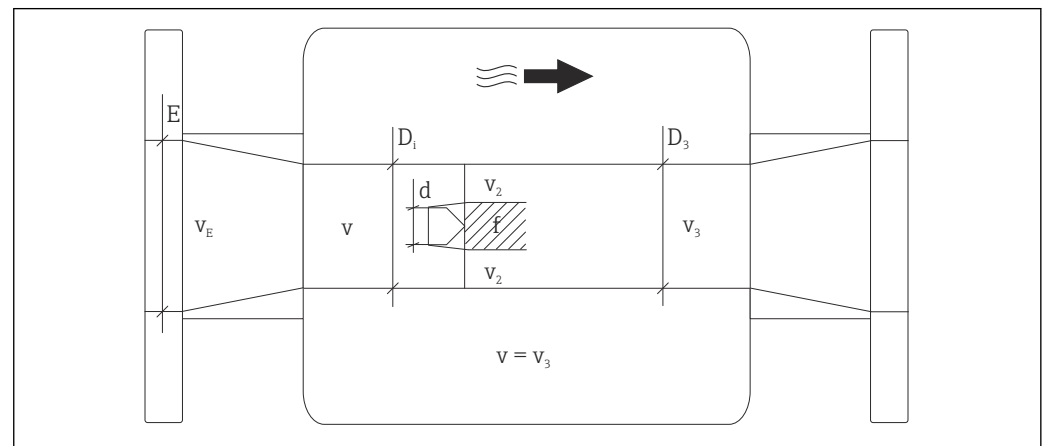
**Flow velocity**

A0027507

- $E$  DN diameter  
 $v_E$  Velocity in process pipe  
 $v$  Bluff body approaching flow velocity ( $Re$  is based on this)  
 $v_2$  Maximum velocity (applies only to oxygen)  $v_2 = v_{max}$   
 $v_3$  Velocity when leaving the measuring device  
 $D_i$  Internal diameter  $D_i = D_3$   
 $D_3$  Internal diameter  $D_3 = D_i$   
 $d$  Width of bluff body  
 $f$  Vortex shedding frequency

 The Applicator can be used for calculation purposes.  $\rightarrow$  183

Maximum volume flow	Strouhal number	Reynolds number
$Q_{\max(G)} = v_{\max} \cdot \frac{\pi}{4} D_i^2$ <p style="text-align: right; font-size: small;">A0027504</p>	$Sr = \frac{f \cdot d}{v}$ <p style="text-align: right; font-size: small;">A0027505</p>	$Re = \frac{\rho \cdot v \cdot D_i}{\mu}$ <p style="text-align: right; font-size: small;">A0027506</p>

**Lower range value**

Depends on the density of the medium and the Reynolds number ( $Re_{\min} = 5\,000$ ,  $Re_{\text{linear}} = 20\,000$ ). The Reynolds number is dimensionless and indicates the ratio of the inertia force of a fluid to its viscous force. It is used to characterize the flow. The Reynolds number is calculated as follows:

$Re = \frac{4 \cdot Q \text{ [m}^3\text{/s]} \cdot \rho \text{ [kg/m}^3\text{]}}{\pi \cdot di \text{ [m]} \cdot \mu \text{ [Pa}\cdot\text{s]}}$	$Re = \frac{4 \cdot Q \text{ [ft}^3\text{/s]} \cdot \rho \text{ [lb/ft}^3\text{]}}{\pi \cdot di \text{ [ft]} \cdot \mu \text{ [0.001 cP]}}$
---	---

A0003794

*Re = Reynolds number; Q = flow; di = internal diameter; μ = dynamic viscosity, ρ = density*

$DN\ 50\dots150 \rightarrow v_{\min.} = \frac{6}{\sqrt{\rho \text{ [kg/m}^3\text{]}}} \text{ [m/s]}$
$DN\ 2\dots6'' \rightarrow v_{\min.} = \frac{4.92}{\sqrt{\rho \text{ [lb/ft}^3\text{]}}} \text{ [ft/s]}$

A0020558

**Upper range value**

**Liquids:**

The upper range value must be calculated as follows:  
 $v_{\max} = 9 \text{ m/s (30 ft/s)}$  and  $v_{\max} = 350/\sqrt{\rho} \text{ m/s (130/\sqrt{\rho} ft/s)}$

- ▶ Use the lower value.

*Gas/steam:*

Nominal diameter	$v_{\max}$
Standard device: DN 50 to 150 (2 to 6")	120 m/s (394 ft/s) and $350/\sqrt{\rho} \text{ m/s (130/\sqrt{\rho} ft/s)}$ (Use the lower value.) Calibrated range: up to 75 m/s (246 ft/s)

For information on the Applicator → 183

Operable flow range

Up to 45: 1 (ratio between lower and upper range value)

## Input signal

**External measured values**

To increase the accuracy of certain measured variables or to calculate the corrected volume flow, the automation system can continuously write different measured values to the measuring device:

- Operating pressure to increase accuracy (Endress+Hauser recommends the use of a pressure measuring device for absolute pressure, e.g. Cerabar M or Cerabar S)
- Medium temperature to increase accuracy (e.g. iTEMP)
- Reference density for calculating the corrected volume flow



▪ Various pressure transmitters can be ordered from Endress+Hauser: see "Accessories" section → 184

- Please comply with the special mounting instructions when using pressure transmitters → 23

It is recommended to read in external measured values to calculate the following measured variables:

- Energy flow
- Mass flow
- Corrected volume flow

*Fieldbuses*

The measured values are written from the automation system to the measuring device via PROFIBUS PA.

## 16.4 Output

## Output signal

**Pulse/frequency/switch output**

<b>Function</b>	Can be set to pulse, frequency or switch output
<b>Version</b>	Passive, open collector
<b>Maximum input values</b>	<ul style="list-style-type: none"> <li>▪ DC 35 V</li> <li>▪ 50 mA</li> </ul>
<b>Voltage drop</b>	<ul style="list-style-type: none"> <li>▪ For ≤ 2 mA: 2 V</li> <li>▪ For 10 mA: 8 V</li> </ul>
<b>Residual current</b>	≤ 0.05 mA
<b>Pulse output</b>	
<b>Pulse width</b>	Adjustable: 5 to 2 000 ms
<b>Maximum pulse rate</b>	100 Impulse/s
<b>Pulse value</b>	Adjustable
<b>Assignable measured variables</b>	<ul style="list-style-type: none"> <li>▪ Total volume flow</li> <li>▪ Total corrected volume flow</li> <li>▪ Total mass flow</li> <li>▪ Total energy flow</li> <li>▪ Total heat flow difference</li> </ul>
<b>Frequency output</b>	
<b>Output frequency</b>	Adjustable: 0 to 1 000 Hz
<b>Damping</b>	Adjustable: 0 to 999 s
<b>Pulse/pause ratio</b>	1:1

<b>Assignable measured variables</b>	<ul style="list-style-type: none"> <li>■ Volume flow</li> <li>■ Corrected volume flow</li> <li>■ Mass flow</li> <li>■ Flow velocity</li> <li>■ Temperature</li> <li>■ Calculated saturated steam pressure</li> <li>■ Steam quality</li> <li>■ Total mass flow</li> <li>■ Energy flow</li> <li>■ Heat flow difference</li> </ul>
<b>Switch output</b>	
<b>Switching behavior</b>	Binary, conductive or non-conductive
<b>Switching delay</b>	Adjustable: 0 to 100 s
<b>Number of switching cycles</b>	Unlimited
<b>Assignable functions</b>	<ul style="list-style-type: none"> <li>■ Off</li> <li>■ On</li> <li>■ Diagnostic behavior</li> <li>■ Limit value                             <ul style="list-style-type: none"> <li>- Volume flow</li> <li>- Corrected volume flow</li> <li>- Mass flow</li> <li>- Flow velocity</li> <li>- Temperature</li> <li>- Calculated saturated steam pressure</li> <li>- Steam quality</li> <li>- Total mass flow</li> <li>- Energy flow</li> <li>- Heat flow difference</li> <li>- Reynolds number</li> <li>- Totalizer 1-3</li> </ul> </li> <li>■ Status</li> <li>■ Status of low flow cut off</li> </ul>

**PROFIBUS PA**

<b>Signal encoding</b>	Manchester Bus Powered (MBP)
<b>Data transfer</b>	31.25 KBit/s, Voltage mode

Signal on alarm

Depending on the interface, failure information is displayed as follows:

**Pulse/frequency/switch output**

<b>Pulse output</b>	
<b>Failure mode</b>	No pulses
<b>Frequency output</b>	
<b>Failure mode</b>	Choose from: <ul style="list-style-type: none"> <li>■ Actual value</li> <li>■ 0 Hz</li> <li>■ Defined value: 0 to 1250 Hz</li> </ul>
<b>Switch output</b>	
<b>Failure mode</b>	Choose from: <ul style="list-style-type: none"> <li>■ Current status</li> <li>■ Open</li> <li>■ Closed</li> </ul>



**PROFIBUS PA**

<b>Status and alarm messages</b>	Diagnostics in accordance with PROFIBUS PA Profile 3.02
<b>Error current FDE (Fault Disconnection Electronic)</b>	0 mA

**Local display**

<b>Plain text display</b>	With information on cause and remedial measures
<b>Backlight</b>	Additionally for device version with SD03 local display: red lighting indicates a device error.

 Status signal as per NAMUR recommendation NE 107

**Operating tool**

- Via digital communication:  
PROFIBUS PA
- Via service interface

<b>Plain text display</b>	With information on cause and remedial measures
---------------------------	---

---

Low flow cut off                      The switch points for low flow cut off are user-selectable.

---

Galvanic isolation                    All outputs are galvanically isolated from one another.

---

Protocol-specific data                **PROFIBUS PA**

<b>Manufacturer ID</b>	0x11
<b>Ident number</b>	0x1564
<b>Profile version</b>	3.02
<b>Device description files (GSD, DTM, DD)</b>	Information and files under: <ul style="list-style-type: none"> <li>▪ <a href="http://www.endress.com">www.endress.com</a></li> <li>▪ <a href="http://www.profibus.org">www.profibus.org</a></li> </ul>

<p><b>Output values</b> (from measuring device to automation system)</p>	<p><b>Analog input 1 to 4</b></p> <ul style="list-style-type: none"> <li>▪ Volume flow</li> <li>▪ Mass flow</li> <li>▪ Corrected volume flow</li> <li>▪ Flow velocity</li> <li>▪ Temperature</li> <li>▪ Calculated saturated steam pressure</li> <li>▪ Steam quality</li> <li>▪ Total mass flow</li> <li>▪ Energy flow</li> <li>▪ Heat flow difference</li> <li>▪ Reynolds number</li> <li>▪ Density</li> <li>▪ Pressure</li> <li>▪ Specific volume</li> <li>▪ Degree of overheating</li> </ul> <p><b>Digital input 1 to 2</b></p> <ul style="list-style-type: none"> <li>▪ Empty pipe detection</li> <li>▪ Low flow cut off</li> <li>▪ Status switch output</li> <li>▪ Status verification</li> </ul> <p><b>Totalizer 1 to 3</b></p> <ul style="list-style-type: none"> <li>▪ Mass flow</li> <li>▪ Volume flow</li> <li>▪ Corrected volume flow</li> <li>▪ Total mass flow</li> <li>▪ Condensate mass flow</li> <li>▪ Energy flow</li> <li>▪ Heat flow difference</li> </ul>
<p><b>Input values</b> (from automation system to measuring device)</p>	<p><b>Analog output</b></p> <ul style="list-style-type: none"> <li>▪ External density</li> <li>▪ External temperature</li> </ul> <p><b>Digital output 1 to 2 (fixed assignment)</b></p> <ul style="list-style-type: none"> <li>▪ Digital output 1: switch positive zero return on/off</li> <li>▪ Digital output 2: start verification</li> </ul> <p><b>Totalizer 1 to 3</b></p> <ul style="list-style-type: none"> <li>▪ Totalize</li> <li>▪ Reset and hold</li> <li>▪ Preset and hold</li> <li>▪ Operating mode configuration:             <ul style="list-style-type: none"> <li>– Net flow total</li> <li>– Forward flow total</li> <li>– Reverse flow total</li> </ul> </li> </ul>
<p><b>Supported functions</b></p>	<ul style="list-style-type: none"> <li>▪ Identification &amp; Maintenance Simplest device identification on the part of the control system and nameplate</li> <li>▪ PROFIBUS upload/download Reading and writing parameters is up to ten times faster with PROFIBUS upload/download</li> <li>▪ Condensed status Simplest and self-explanatory diagnostic information by categorizing diagnostic messages that occur</li> </ul>
<p><b>Configuration of the device address</b></p>	<ul style="list-style-type: none"> <li>▪ DIP switches on the I/O electronics module</li> <li>▪ Local display</li> <li>▪ via operating tools (e.g. FieldCare)</li> </ul>

## 16.5 Power supply

Terminal assignment →  32

Pin assignment, device plug →  33

## Supply voltage

**Transmitter**

An external power supply is required for each output.

The following supply voltage values apply for the outputs available:

*Supply voltage for a compact version without a local display<sup>1)</sup>*

Order code for "Output"	Minimum terminal voltage <sup>2)</sup>	Maximum terminal voltage
Option <b>G</b> : PROFIBUS PA, pulse/frequency/switch output	≥ DC 9 V	DC 32 V

1) In event of external supply voltage of the PROFIBUS DP/PA coupler

2) The minimum terminal voltage increases if local operation is used: see the following table

*Increase in minimum terminal voltage*

Local operation	Increase in minimum terminal voltage
Order code for "Display; Operation", option <b>C</b> : Local operation SDO2	+ DC 1 V
Order code for "Display; Operation", option <b>E</b> : Local operation SDO3 with lighting (backlighting <b>not used</b> )	+ DC 1 V
Order code for "Display; Operation", option <b>E</b> : Local operation SDO3 with lighting (backlighting <b>used</b> )	+ DC 3 V

## Power consumption

**Transmitter**

Order code for "Output"	Maximum power consumption
Option <b>G</b> : PROFIBUS PA, pulse/frequency/switch output	<ul style="list-style-type: none"> <li>■ Operation with output 1: 512 mW</li> <li>■ Operation with output 1 and 2: 2 512 mW</li> </ul>

## Current consumption

**PROFIBUS PA**

15 mA

## Power supply failure

- Totalizers stop at the last value measured.
- Configuration is retained in the device memory (HistoROM).
- Error messages (incl. total operated hours) are stored.

## Electrical connection

→  35

## Terminals

- For device version without integrated overvoltage protection: plug-in spring terminals for wire cross-sections 0.5 to 2.5 mm<sup>2</sup> (20 to 14 AWG)
- For device version with integrated overvoltage protection: screw terminals for wire cross-sections 0.2 to 2.5 mm<sup>2</sup> (24 to 14 AWG)

## Cable entries

- Cable gland: M20 × 1.5 with cable  $\phi$ 6 to 12 mm (0.24 to 0.47 in)
- Thread for cable entry:
  - NPT 1/2"
  - G 1/2"

Cable specification →  29

Overvoltage protection The device can be ordered with integrated overvoltage protection for diverse approvals:  
*Order code for "Accessory mounted", option NA "Overvoltage protection"*

<b>Input voltage range</b>	Values correspond to supply voltage specifications <sup>1)</sup>
<b>Resistance per channel</b>	2 · 0.5 Ω max
<b>DC sparkover voltage</b>	400 to 700 V
<b>Trip surge voltage</b>	< 800 V
<b>Capacitance at 1 MHz</b>	< 1.5 pF
<b>Nominal discharge current (8/20 μs)</b>	10 kA
<b>Temperature range</b>	-40 to +85 °C (-40 to +185 °F)

1) The voltage is reduced by the amount of the internal resistance  $I_{min} \cdot R_i$

 Depending on the temperature class, restrictions apply to the ambient temperature for device versions with overvoltage protection .

 For detailed information on the temperature tables, see the separate document entitled "Safety Instructions" (XA) for the device.

## 16.6 Performance characteristics

Reference operating conditions

- Error limits following ISO/DIN 11631
- +20 to +30 °C (+68 to +86 °F)
- 2 to 4 bar (29 to 58 psi)
- Calibration system traceable to national standards
- Calibration with the process connection corresponding to the particular standard

 To obtain measured errors, use the *Applicator* sizing tool →  183 →  207

Maximum measured error

### Base accuracy

o.r. = of reading, Re = Reynolds number

### Volume flow

The measured error for the volume flow is as follows depending on the Reynolds number and the compressibility of the medium under measurement:

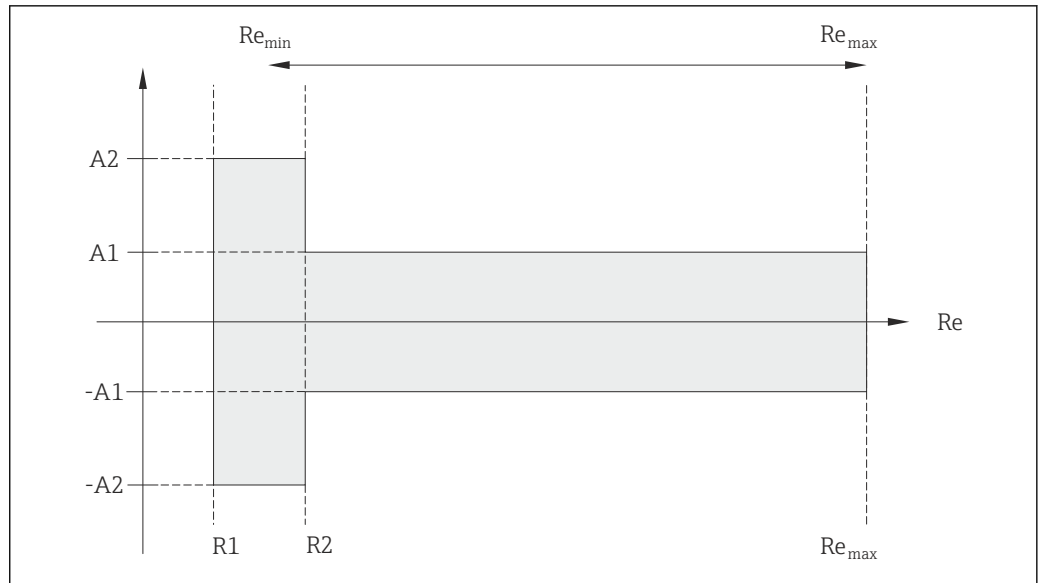

A0019703

Deviation of volume flow value (absolute) from the reading			
Medium type		Incompressible	Compressible <sup>1)</sup>
Re range	Measured value deviation	Standard	Standard
R1 to R2	A2	< 10 %	< 10 %
R2 to Re <sub>max</sub>	A1	< 0.75 %	< 1.0 %

1) Accuracy specifications valid up to 75 m/s (246 ft/s)

Reynolds numbers	Incompressible	Compressible
	Standard	Standard
R1	5 000	
R2	20 000	

**Temperature**

- Saturated steam and liquids at room temperature if T > 100 °C (212 °F) applies: < 1 °C (1.8 °F)
- Gas: < 1 % o.r. [K]
- Volume flow: > 70 m/s (230 ft/s): 2% o.r.

Rise time 50 % (stirred under water, following IEC 60751): 8 s

**Mass flow (saturated steam)**

- Flow velocities 20 to 50 m/s (66 to 164 ft/s), T > 150 °C (302 °F) or (423 K)
  - Re > 20 000: < 1.7 % o.r.
  - Re between 5 000 to 20 000: < 10 % o.r.
- Flow velocities 10 to 70 m/s (33 to 210 ft/s), T > 140 °C (284 °F) or (413 K)
  - Re > 20 000: < 2 % o.r.
  - Re between 5 000 to 20 000: < 10 % o.r.
- Flow velocities < 10 m/s (33 ft/s): Re > 5000: 5%

**i** The use of a Cerabar S is required for the measured errors listed in the following section. The measured error used to calculate the error in the measured pressure is 0.15%.

**Mass flow of superheated steam and gas (single gas, gas mixture, air: NEL40; natural gas: ISO 12213-2 contains AGA8-DC92, AGA NX-19, ISO 12213-3 contains SGERG-88 and AGA8 Gross Method 1)**

- Re > 20 000 and process pressure < 40 bar abs. (580 psi abs.): 1.7 % o.r.
- Re between 5 000 to 20 000 and process pressure < 40 bar abs. (580 psi abs.): 10 % o.r.
- Re > 20 000 and process pressure < 120 bar abs. (1 740 psi abs.): 2.6 % o.r.
- Re between 5 000 to 20 000 and process pressure < 120 bar abs. (1 740 psi abs.): 10 % o.r.

abs. = absolute

**Mass flow (water)**

- Re 20 000: < 0.85 % o.r.
- Re between 5 000 to 20 000: < 10 % o.r.

**Mass flow (user-defined liquids)**

To specify the system accuracy, Endress+Hauser requires information about the type of liquid and its operating temperature or information in table form about the dependency between the liquid density and the temperature.

*Example*

- Acetone is to be measured at fluid temperatures from +70 to +90 °C (+158 to +194 °F).
- For this purpose, the **Reference temperature** parameter (7703) (here 80 °C (176 °F)), **Reference density** parameter (7700) (here 720.00 kg/m<sup>3</sup>) and **Linear expansion coefficient** parameter (7621) (here 18.0298 × 10<sup>-4</sup> 1/°C) must be entered in the transmitter.
- The overall system uncertainty, which is less than 0.9 % for the example above, is comprised of the following measurement uncertainties: uncertainty of volume flow measurement, uncertainty of temperature measurement, uncertainty of the density-temperature correlation used (incl. the resulting uncertainty of density).

**Mass flow (other media)**

Depends on the selected fluid and the pressure value, which is specified in the parameters. Individual error analysis must be performed.

**Accuracy of outputs**

The outputs have the following base accuracy specifications.

*Pulse/frequency output*

o.r. = of reading

<b>Accuracy</b>	Max. ±100 ppm o.r.
-----------------	--------------------

Repeatability o.r. = of reading  
±0.2 % o.r.

Response time If all the configurable functions for filter times (flow damping, display damping, current output time constant, frequency output time constant, status output time constant) are set to 0, in the event of vortex frequencies of 10 Hz and higher a response time of max(T<sub>v</sub>, 100 ms) can be expected.  
  
In the event of measuring frequencies < 10 Hz, the response time is > 100 ms and can be up to 10 s. T<sub>v</sub> is the average vortex period duration of the flowing fluid.

Influence of ambient temperature **Pulse/frequency output**  
o.r. = of reading

<b>Temperature coefficient</b>	Max. $\pm 100$ ppm o.r.
--------------------------------	-------------------------



## 16.7 Installation

"Mounting requirements" →  19

## 16.8 Environment

Ambient temperature range

### Temperature tables

-  Observe the interdependencies between the permitted ambient and fluid temperatures when operating the device in hazardous areas.
-  For detailed information on the temperature tables, see the separate document entitled "Safety Instructions" (XA) for the device.

Storage temperature

All components apart from the display modules:  
-50 to +80 °C (-58 to +176 °F)

### Remote display and operating module DKX001

-50 to +80 °C (-58 to +176 °F)

Climate class

DIN EN 60068-2-38 (test Z/AD)

Degree of protection

### Transmitter

- As standard: IP66/67, type 4X enclosure
- When housing is open: IP20, type 1 enclosure
- Display module: IP20, type 1 enclosure

### Sensor

IP66/67, type 4X enclosure

### Device plugs

IP67, only in screwed situation

Vibration resistance

- For compact/remote version made of coated aluminum and remote version made of stainless steel:  
Acceleration up to 2 g (if gain set to factory setting), 10 to 500 Hz, following IEC 60068-2-6
- For the compact version made of stainless steel:  
Acceleration up to 1 g (if gain set to factory setting), 10 to 500 Hz, following IEC 60068-2-6

Electromagnetic compatibility (EMC)

As per IEC/EN 61326 and NAMUR Recommendation 21 (NE 21)

-  For details, refer to the Declaration of Conformity.

## 16.9 Process

Medium temperature range **DSC sensor**<sup>3)</sup>

Order code for "Sensor version":

- Option 1 "Volume flow, basis":  
-40 to +260 °C (-40 to +500 °F), stainless steel
- Option 2 "Volume flow, high-temperature/low-temperature":  
-200 to +400 °C (-328 to +752 °F), stainless steel
- Option 3 "Mass flow (integrated temperature measurement)":  
-200 to +400 °C (-328 to +752 °F), stainless steel

Order code for "Sensor option":

Option CD "Harsh environment"<sup>4)</sup>, DSC sensor components Alloy C22":  
-200 to +400 °C (-328 to +752 °F), DSC sensor Alloy C22

### Seals

- -200 to +400 °C (-328 to +752 °F) for graphite (standard)
- -15 to +175 °C (+5 to +347 °F) for Viton
- -20 to +275 °C (-4 to +527 °F) for Kalrez
- -200 to +260 °C (-328 to +500 °F) for Gylon

Pressure-temperature ratings



An overview of the pressure-temperature ratings for the process connections is provided in the "Technical Information" document

Secondary containment pressure rating

The following overpressure resistance values apply to the sensor shaft in the event of a membrane rupture:

Sensor version	Overpressure, sensor shaft in [bar a]
Volume flow, basis	200
Volume flow, high-temperature/low-temperature	200
Mass flow (integrated temperature measurement)	200

Pressure loss

For a precise calculation, use the Applicator → 183.

## 16.10 Mechanical construction

Design, dimensions



For the dimensions and installation lengths of the device, see the "Technical Information" document, "Mechanical construction" section

Weight

### Compact version

Weight data:

- Including the transmitter:  
Order code for "Housing", option C: 1.8 kg (4.0 lb)
- Excluding packaging material

3) Capacitance sensor

4) Aggressive atmosphere (salts or chloride in the air)



*Weight in SI units*

All values (weight) refer to devices with ASME B16.5/Class 900 flanges. Weight information in [kg].

DN [mm]	Weight [kg]
	Order code for "Housing", option C Aluminum, AlSi10Mg, coated
50	26.8
80	34.1
100	53.9
150	112.7

*Weight in US units*

All values (weight) refer to devices with ASME B16.5/Class 900 flanges. Weight information in [lbs].

DN [in]	Weight [lbs]
	Order code for "Housing", option C Aluminum, AlSi10Mg, coated
2	59.1
3	75.2
4	118.8
6	248.5

**Transmitter remote version***Wall-mount housing*

Depends on the material of the wall-mount housing:

- Aluminum, AlSi10Mg, coated: 2.4 kg (5.2 lb)
- Stainless steel, 1.4404 (316L): 6.0 kg (13.2 lb)

**Sensor remote version**

Weight data:

- Including the connection housing:  
Aluminum, AlSi10Mg, coated: 0.8 kg (1.8 lb)
- Excluding the connecting cable
- Excluding packaging material

*Weight in SI units*

All values (weight) refer to devices with ASME B16.5/Class 900 flanges. Weight information in [kg].

DN [mm]	Weight [kg]
	Connection housing Aluminum, AlSi10Mg, coated
50	25.7
80	33.1
100	52.8
150	111.6

*Weight in US units*

All values (weight) refer to devices with ASME B16.5/Class 900 flanges. Weight information in [lbs].

DN [in]	Weight [lbs]
	Connection housing Aluminum, AlSi10Mg, coated
2	56.7
3	73.0
4	116.4
6	246.0

Materials

**Transmitter housing**

*Compact version*

- Order code for "Housing", option C "Compact, aluminum coated":  
Aluminum, AlSi10Mg, coated
- Window material: glass

*Remote version*

- Order code for "Housing", option J "Remote, aluminum coated":  
Aluminum, AlSi10Mg, coated
- Window material: glass

**Cable entries/cable glands**

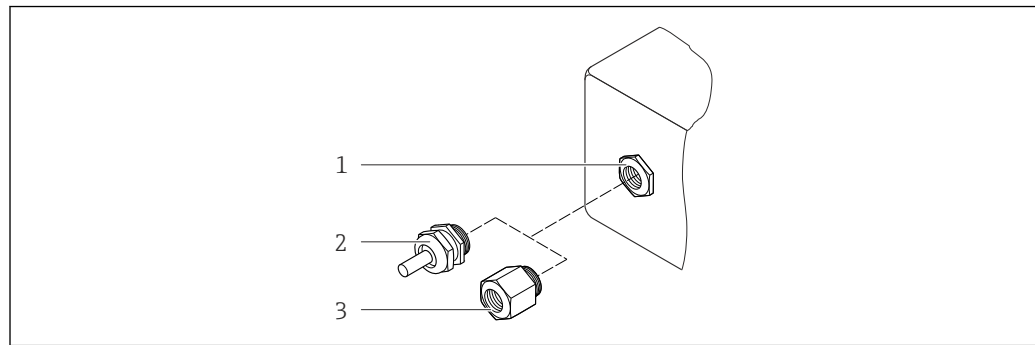

A0020640

36 Possible cable entries/cable glands

- 1 Cable entry in transmitter housing, wall-mount housing or connection housing with internal thread M20 x 1.5
- 2 Cable gland M20 x 1.5
- 3 Adapter for cable entry with internal thread G 1/2" or NPT 1/2"

Order code for "Housing": option C "Compact, aluminum coated", option J "Remote, aluminum coated"

Cable entry/cable gland	Type of protection	Material
Cable gland M20 x 1.5	<ul style="list-style-type: none"> <li>■ Non-Ex</li> <li>■ Ex ia</li> <li>■ Ex ic</li> </ul>	Plastic
	Adapter for cable entry with internal thread G 1/2"	Nickel-plated brass

Cable entry/cable gland	Type of protection	Material
Adapter for cable entry with internal thread NPT ½"	For non-Ex and Ex (except for CSA Ex d/XP)	Nickel-plated brass
Thread NPT ½" via adapter	For non-Ex and Ex	

### Connecting cable for remote version

- Standard cable: PVC cable with copper shield
- Reinforced cable: PVC cable with copper shield and additional steel wire braided jacket

### Sensor connection housing

Coated aluminum AlSi10Mg

### Measuring tubes

#### Pressure ratings Class 600 to 900

Carbon steel, multiple certifications, SA-106 Grade B, SA-333 Grade 6

#### Bluff body

Carbon steel, multiple certifications, SA-105, SA-350 LF2 (1)

#### Inspection ports

Carbon steel, multiple certifications, SA-105, SA-350 LF2 (1)

### DSC sensor

- Parts in contact with medium (marked as "wet" on the DSC sensor flange):  
UNS N07718 similar to Alloy 718/2.4668
- Parts not in contact with medium:  
Stainless steel 1.4301 (304)

### Process connections

ASME B16.5

Carbon steel, multiple certifications, SA-105, SA-350 LF2 (1)

 List of all available process connections →  204

### Seals

- Graphite (standard)  
Sigraflex Hochdruck™ with smooth sheet metal insert made of stainless steel, 316/316L (BAM-certified for oxygen applications, "high quality in terms of TA Luft" (German Clean Air Act))
- FPM (Viton)<sup>5)</sup>
- Kalrez 6375
- Gylon 3504 (BAM-certified for oxygen applications, "high quality in terms of TA Luft" (German Clean Air Act))

### Housing support

Stainless steel ,304

5) Only available for the DSC sensor, not for inspection ports.



**Accessories**

*Weather protection cover*

Stainless steel 1.4404 (316L)

Process connections

ASME B16.5

 For information on the different materials used in the process connections →  203

**16.11 Operability**

Local operation



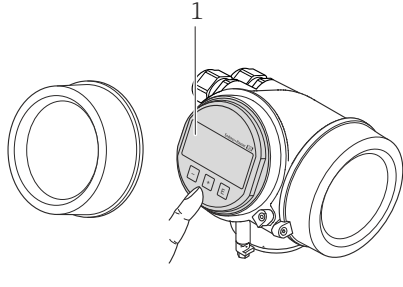
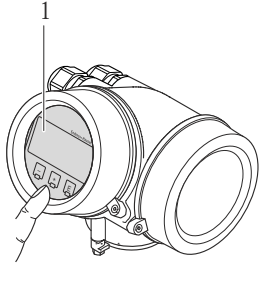



**Via display module**

Order code for "Display; Operation", option <b>C</b> "SD02"	Order code for "Display; Operation", option <b>E</b> "SD03"
 <p style="text-align: right; font-size: small;">A0015544</p>	 <p style="text-align: right; font-size: small;">A0015546</p>
<p>1 <i>Operation with pushbuttons</i></p>	<p>1 <i>Operation with touch control</i></p>

**Display elements**

- 4-line display
- With order code for "Display; operation", option **E**:  
White background lighting; switches to red in event of device errors
- Format for displaying measured variables and status variables can be individually configured
- Permitted ambient temperature for the display: -20 to +60 °C (-4 to +140 °F)  
The readability of the display may be impaired at temperatures outside the temperature range.

**Operating elements**

- With order code for "Display; operation", option **C**:  
Local operation with 3 push buttons: , , 
- With order code for "Display; operation", option **E**:  
External operation via touch control; 3 optical keys: , , 
- Operating elements also accessible in various hazardous areas

**Additional functionality**

- Data backup function  
The device configuration can be saved in the display module.
- Data comparison function  
The device configuration saved in the display module can be compared to the current device configuration.
- Data transfer function  
The transmitter configuration can be transmitted to another device using the display module.

**Via remote display and operating module FHX50**

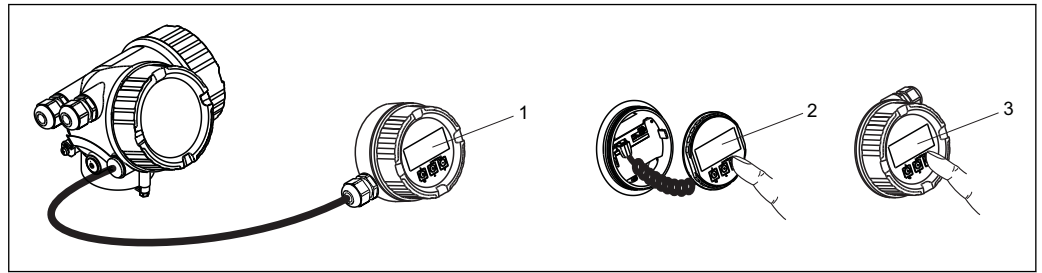

A0013137

37 Operating options via FHX50

- 1 Housing of remote display and operating module FHX50
- 2 SD02 display and operating module, push buttons: cover must be opened for operation
- 3 SD03 display and operating module, optical buttons: operation possible through cover glass

Remote operation

**Via PROFIBUS PA network**

This communication interface is available in device versions with PROFIBUS PA.

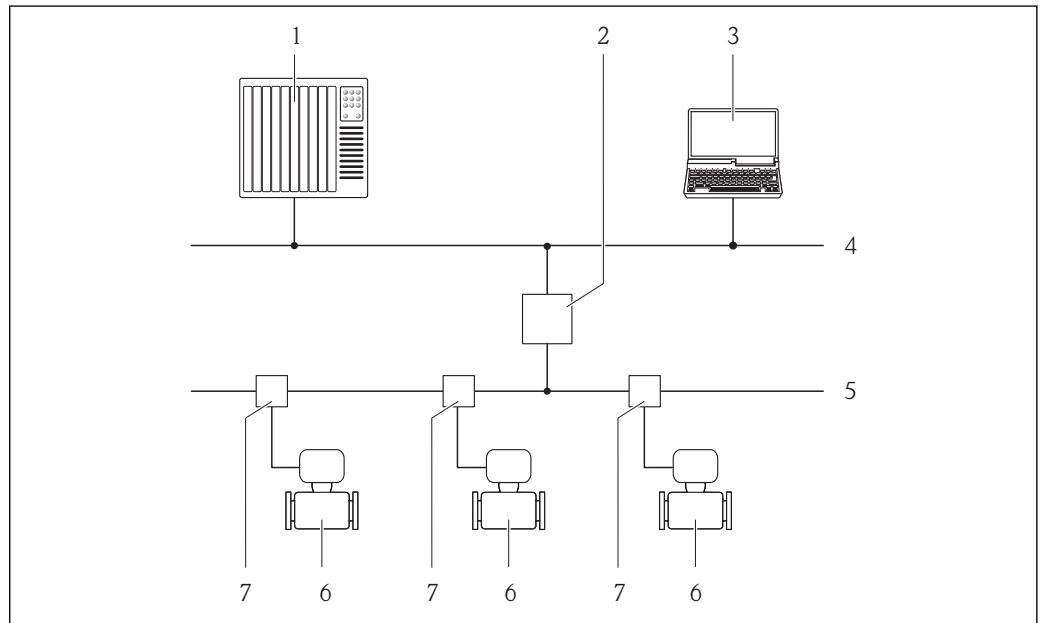

A0019013

38 Options for remote operation via PROFIBUS PA network

- 1 Automation system
- 2 Segment coupler PROFIBUS DP/PA
- 3 Computer with PROFIBUS network card
- 4 PROFIBUS DP network
- 5 PROFIBUS PA network
- 6 Measuring device
- 7 T-box

Service interface

**Via service interface (CDI)**

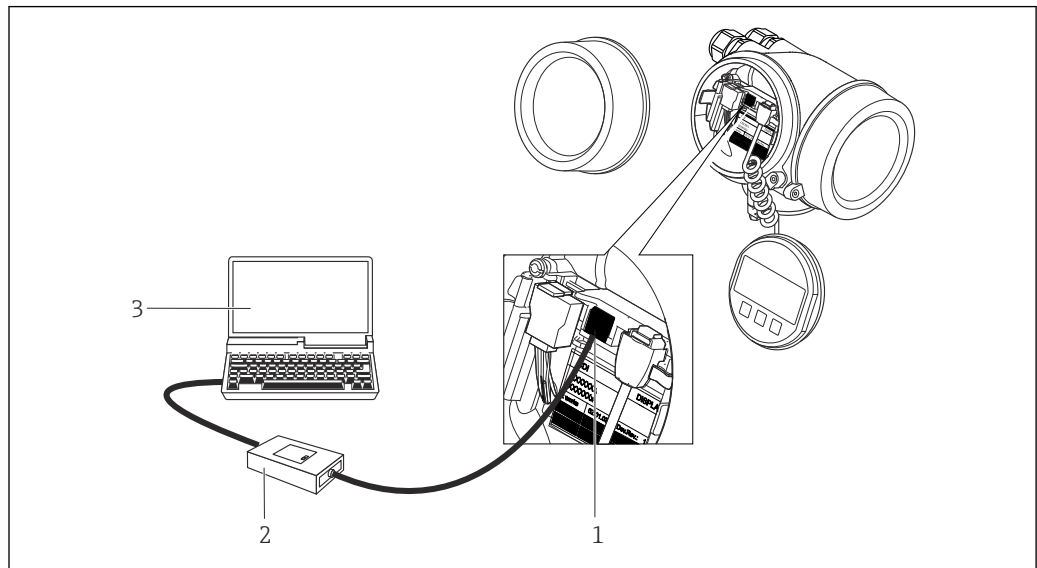

- 1 Service interface (CDI = Endress+Hauser Common Data Interface) of the measuring device  
 2 Commubox FXA291  
 3 Computer with "FieldCare" operating tool with COM DTM "CDI Communication FXA291"

Languages

Can be operated in the following languages:

- Via local display:  
 English, German, French, Spanish, Italian, Dutch, Portuguese, Polish, Russian, Swedish, Turkish, Chinese, Japanese, Korean, Bahasa (Indonesian), Vietnamese, Czech
- Via "FieldCare" operating tool:  
 English, German, French, Spanish, Italian, Chinese, Japanese

## 16.12 Certificates and approvals

C-Tick symbol

The measuring system meets the EMC requirements of the "Australian Communications and Media Authority (ACMA)".

Ex approval

The devices are certified for use in hazardous areas and the relevant safety instructions are provided in the separate "Safety Instructions" (XA) document. Reference is made to this document on the nameplate.

Certification PROFIBUS

**PROFIBUS interface**

The measuring device is certified and registered by the PROFIBUS User Organization (PNO). The measuring system meets all the requirements of the following specifications:

- Certified in accordance with PROFIBUS PA Profile 3.02
- The device can also be operated with certified devices of other manufacturers (interoperability)

Experience

The Prowirl 200 measuring system is the official successor to Prowirl 72 and Prowirl 73.



#### Other standards and guidelines

- EN 60529  
Degrees of protection provided by enclosures (IP code)
- DIN ISO 13359  
Measurement of conductive liquid flow in closed conduits - Flanged-type electromagnetic flowmeters - Overall length
- EN 61010-1  
Safety requirements for electrical equipment for measurement, control and laboratory use - general requirements
- IEC/EN 61326  
Emission in accordance with Class A requirements. Electromagnetic compatibility (EMC requirements).
- NAMUR NE 21  
Electromagnetic compatibility (EMC) of industrial process and laboratory control equipment
- NAMUR NE 32  
Data retention in the event of a power failure in field and control instruments with microprocessors
- NAMUR NE 43  
Standardization of the signal level for the breakdown information of digital transmitters with analog output signal.
- NAMUR NE 53  
Software of field devices and signal-processing devices with digital electronics
- NAMUR NE 105  
Specifications for integrating fieldbus devices in engineering tools for field devices
- NAMUR NE 107  
Self-monitoring and diagnosis of field devices
- NAMUR NE 131  
Requirements for field devices for standard applications
- ASME BPVC Section VIII, Division 1  
Rules for Construction of Pressure Vessels

### 16.13 Application packages

Many different application packages are available to enhance the functionality of the device. Such packages might be needed to address safety aspects or specific application requirements.

The application packages can be ordered with the device or subsequently from Endress+Hauser. Detailed information on the order code in question is available from your local Endress+Hauser sales center or on the product page of the Endress+Hauser website: [www.endress.com](http://www.endress.com).

-  Detailed information on the application packages:
- Special Documentation for the device →  208
  - Special Documentation for the device

### 16.14 Accessories

-  Overview of accessories available for order →  182

## 16.15 Supplementary documentation

 For an overview of the scope of the associated Technical Documentation, refer to the following:

- The *W@M Device Viewer* : Enter the serial number from the nameplate ([www.endress.com/deviceviewer](http://www.endress.com/deviceviewer))
- The *Endress+Hauser Operations App*: Enter the serial number from the nameplate or scan the 2-D matrix code (QR code) on the nameplate.

### Standard documentation

#### Brief Operating Instructions

Measuring device	Documentation code
Prowirl C 200	KA01134D

#### Technical Information

Measuring device	Documentation code
Prowirl C 200	TI01082D

#### Description of device parameters

Measuring device	Documentation code
Prowirl 200	GP01023D

### Supplementary device-dependent documentation



#### Safety Instructions

Contents	Documentation code
cCSA <sub>US</sub> XP	XA01153D
cCSA <sub>US</sub> IS	XA01154D

#### Special Documentation

Contents	Documentation code
Heartbeat Technology	SD01204D
Natural gas	SD01194D
Air + Industrial Gases (Single Gas + Gas Mixtures)	SD01195D
ERCB Dir. 017	SD01213D

#### Installation Instructions

Contents	Documentation code
Installation Instructions for spare part sets	 Overview of accessories available for order →  182



# Index

## A

- Access authorization to parameters
  - Read access . . . . . 58
  - Write access . . . . . 58
- Access code . . . . . 58
  - Incorrect input . . . . . 58
- Adapting the device status . . . . . 141
- Adapting the diagnostic behavior . . . . . 142
- Adapting the measured value status . . . . . 141
- Ambient temperature
  - Influence . . . . . 198
- Ambient temperature range . . . . . 22
- Application . . . . . 9, 185
- Applicator . . . . . 189
- Approvals . . . . . 206

## C

- C-Tick symbol . . . . . 206
- Cable entries
  - Technical data . . . . . 195
- Cable entry
  - Degree of protection . . . . . 43
- CE mark . . . . . 10
- Certificates . . . . . 206
- Certification PROFIBUS . . . . . 206
- Check
  - Installation . . . . . 27
- Checklist
  - Post-connection check . . . . . 44
  - Post-installation check . . . . . 27
- Cleaning
  - Exterior cleaning . . . . . 177
  - Interior cleaning . . . . . 177
  - Replacing housing seals . . . . . 177
  - Replacing seals . . . . . 177
  - Replacing sensor seals . . . . . 177
- Climate class . . . . . 199
- Commissioning . . . . . 72
  - Advanced settings . . . . . 86
  - Configuring the measuring device . . . . . 74
- Compatibility with earlier model . . . . . 63
- Connecting cable . . . . . 29
- Connecting the measuring device . . . . . 35
- Connection
  - see Electrical connection
- Connection preparations . . . . . 35
- Connection tools . . . . . 29
- Context menu
  - Closing . . . . . 53
  - Explanation . . . . . 53
  - Opening . . . . . 53
- Current consumption . . . . . 195
- Cyclic data transmission . . . . . 65

## D

- Declaration of Conformity . . . . . 10

- Define access code . . . . . 124
- Degree of protection . . . . . 43, 199
- Designated use . . . . . 9
- Device components . . . . . 11
- Device description files . . . . . 63
- Device documentation
  - Supplementary documentation . . . . . 8
- Device locking, status . . . . . 127
- Device master file
  - GSD . . . . . 63
- Device name
  - Sensor . . . . . 14
  - Transmitter . . . . . 13
- Device repair . . . . . 179
- Device type code . . . . . 63
- Diagnostic behavior
  - Explanation . . . . . 138
  - Symbols . . . . . 138
- Diagnostic information
  - Design, description . . . . . 138, 140
  - FieldCare . . . . . 139
  - Local display . . . . . 137
  - Overview . . . . . 145
  - Remedy information . . . . . 145
- Diagnostic list . . . . . 171
- Diagnostic message . . . . . 137
- Diagnostics
  - Symbols . . . . . 137
- DIP switches
  - see Write protection switch
- Direct access . . . . . 55
- Direct access code . . . . . 50
- Disabling write protection . . . . . 124
- Display
  - see Local display
- Display area
  - For operational display . . . . . 48
  - In the navigation view . . . . . 50
- Display values
  - For locking status . . . . . 127
- Disposal . . . . . 180
- Document
  - Function . . . . . 6
  - Symbols used . . . . . 6
- Document function . . . . . 6

## E

- Electrical connection
  - Commubox FXA291 . . . . . 60, 206
  - Degree of protection . . . . . 43
  - Measuring device . . . . . 29
  - Operating tools
    - Via PROFIBUS PA network . . . . . 59, 205
    - Via service interface (CDI) . . . . . 60, 206
- Electromagnetic compatibility . . . . . 199
- Enabling write protection . . . . . 124

- Endress+Hauser services
  - Maintenance . . . . . 178
  - Repair . . . . . 180
- Environment
  - Ambient temperature range . . . . . 22
  - Storage temperature . . . . . 199
  - Vibration resistance . . . . . 199
- Error messages
  - see Diagnostic messages
- Event history . . . . . 171
- Events list . . . . . 171
- Ex approval . . . . . 206
- Experience . . . . . 206
- Extended order code
  - Sensor . . . . . 14
  - Transmitter . . . . . 13
- Exterior cleaning . . . . . 177
- F**
  - Field of application
    - Residual risks . . . . . 10
  - FieldCare . . . . . 61
    - Device description file . . . . . 63
    - Establishing a connection . . . . . 61
    - Function . . . . . 61
    - User interface . . . . . 62
  - Filtering the event logbook . . . . . 171
  - Firmware
    - Release date . . . . . 63
    - Version . . . . . 63
  - Firmware history . . . . . 176
  - Flow direction . . . . . 19
  - Function check . . . . . 72
  - Function scope
    - SIMATIC PDM . . . . . 62
  - Functions
    - see Parameter
- G**
  - Galvanic isolation . . . . . 193
- H**
  - Hardware write protection . . . . . 125
  - Help text
    - Calling up . . . . . 56
    - Close . . . . . 56
    - Explanation . . . . . 56
  - HistoROM . . . . . 120
- I**
  - I/O electronics module . . . . . 11, 39
  - Identifying the measuring device . . . . . 12
  - Incoming acceptance . . . . . 12
  - Influence
    - Ambient temperature . . . . . 198
  - Information on the document . . . . . 6
  - Inlet runs . . . . . 20
  - Input . . . . . 185
  - Input mask . . . . . 51
- Inspection
  - Received goods . . . . . 12
- Inspection check
  - Connection . . . . . 44
- Installation . . . . . 19
- Installation conditions
  - Inlet and outlet runs . . . . . 20
  - Mounting location . . . . . 19
  - Orientation . . . . . 19
  - Thermal insulation . . . . . 22
  - Vibrations . . . . . 23
- Installation dimensions . . . . . 22
- Interior cleaning . . . . . 177
- K**
  - Keypad lock
    - Disabling . . . . . 58
    - Enabling . . . . . 58
- L**
  - Languages, operation options . . . . . 206
  - Line recorder . . . . . 132
  - Local display . . . . . 204
    - Editing view . . . . . 51
    - Navigation view . . . . . 49
    - see Diagnostic message
    - see In alarm condition
    - see Operational display
  - Low flow cut off . . . . . 193
- M**
  - Main electronics module . . . . . 11
  - Maintenance tasks . . . . . 177
  - Managing the device configuration . . . . . 120
  - Manufacturer ID . . . . . 63
  - Manufacturing date . . . . . 13, 14
  - Materials . . . . . 202
  - Maximum measured error . . . . . 196
  - Measured variables
    - Calculated . . . . . 185
    - Measured . . . . . 185
    - see Process variables
  - Measuring and test equipment . . . . . 177, 178
  - Measuring device
    - Configuration . . . . . 74
    - Conversion . . . . . 179
    - Disposal . . . . . 181
    - Mounting the sensor . . . . . 25
    - Preparing for electrical connection . . . . . 35
    - Preparing for mounting . . . . . 24
    - Removing . . . . . 180
    - Repair . . . . . 179
    - Structure . . . . . 11
    - Switch-on . . . . . 72
  - Measuring principle . . . . . 185
  - Measuring range . . . . . 189
  - Measuring system . . . . . 185
  - Media . . . . . 9
  - Medium temperature range . . . . . 200

- Menu
  - Diagnostics . . . . . 170
  - Operation . . . . . 127
  - Setup . . . . . 74
- Menus
  - For measuring device configuration . . . . . 74
  - For specific settings . . . . . 86
- Mounting dimensions
  - see Installation dimensions
- Mounting location . . . . . 19
- Mounting preparations . . . . . 24
- Mounting requirements
  - Installation dimensions . . . . . 22
- Mounting tools . . . . . 24
- N**
- Nameplate
  - Sensor . . . . . 14
  - Transmitter . . . . . 13
- Navigation path (navigation view) . . . . . 49
- Navigation view
  - In the submenu . . . . . 49
  - In the wizard . . . . . 49
- Nominal pressure
  - Secondary containment . . . . . 200
- Numeric editor . . . . . 51
- O**
- Operable flow range . . . . . 190
- Operating elements . . . . . 52, 138
- Operating keys
  - see Operating elements
- Operating menu
  - Menus, submenus . . . . . 46
  - Structure . . . . . 46
  - Submenus and user roles . . . . . 47
- Operating options . . . . . 45
- Operating philosophy . . . . . 47
- Operation . . . . . 127
- Operation options . . . . . 45
- Operational display . . . . . 48
- Operational safety . . . . . 10
- Order code . . . . . 12, 13, 14
- Orientation (vertical, horizontal) . . . . . 19
- Outlet runs . . . . . 20
- Output . . . . . 191
- Output signal . . . . . 191
- P**
- Packaging disposal . . . . . 18
- Parameter
  - Changing . . . . . 57
  - Enter a value . . . . . 57
- Parameter settings
  - Administration (Submenu) . . . . . 173
  - Analog inputs (Submenu) . . . . . 81
  - Communication (Submenu) . . . . . 83
  - Configuration backup display (Submenu) . . . . . 120
  - Data logging (Submenu) . . . . . 132
  - Device information (Submenu) . . . . . 173
  - Diagnostics (Menu) . . . . . 170
  - Display (Submenu) . . . . . 118
  - Display (Wizard) . . . . . 82
  - External compensation (Submenu) . . . . . 101
  - Gas composition (Submenu) . . . . . 90
  - Low flow cut off (Wizard) . . . . . 84
  - Medium properties (Submenu) . . . . . 87
  - Medium selection (Wizard) . . . . . 76
  - Operation (Submenu) . . . . . 131
  - Output values (Submenu) . . . . . 131
  - Process variables (Submenu) . . . . . 127
  - Pulse/frequency/switch output (Wizard) 105, 108, 112
  - Sensor adjustment (Submenu) . . . . . 103
  - Setup (Menu) . . . . . 74
  - Simulation (Submenu) . . . . . 122
  - System units (Submenu) . . . . . 78
  - Totalizer 1 to 3 (Submenu) . . . . . 116, 130
- Performance characteristics . . . . . 196
- Post-connection check (checklist) . . . . . 44
- Post-installation check . . . . . 72
- Post-installation check (checklist) . . . . . 27
- Potential equalization . . . . . 41
- Power consumption . . . . . 195
- Power supply failure . . . . . 195
- Pressure loss . . . . . 200
- Pressure-temperature ratings . . . . . 200
- Process
  - Pressure loss . . . . . 200
- Process conditions
  - Medium temperature . . . . . 200
- Process connections . . . . . 204
- Product safety . . . . . 10
- Profile version . . . . . 63
- Protecting parameter settings . . . . . 124
- R**
- Read access . . . . . 58
- Reading measured values . . . . . 127
- Recalibration . . . . . 178
- Reference operating conditions . . . . . 196
- Registered trademarks . . . . . 8
- Remedial measures
  - Calling up . . . . . 139
  - Closing . . . . . 139
- Remote operation . . . . . 205
- Remote version
  - Connecting the connecting cable . . . . . 35
- Repair . . . . . 179
  - Notes . . . . . 179
- Repair of a device . . . . . 179
- Repeatability . . . . . 198
- Replacement
  - Device components . . . . . 179
- Replacing seals . . . . . 177
- Requirements for personnel . . . . . 9
- Response time . . . . . 198
- Return . . . . . 180

**S**

Safety	9
Sensor	
Mounting	25
Serial number	13, 14
Setting the operating language	72
Settings	
Adapting the measuring device to the process conditions	131
Advanced display configurations	118
Analog input	81
Communication interface	83
Device reset	173
Device tag	74
External compensation	101
Gas composition	90
Local display	82
Low flow cut off	84
Managing the device configuration	120
Medium	76
Medium properties	87
Operating language	72
Pulse output	105
Pulse/frequency/switch output	104, 108
Resetting the totalizer	131
Sensor adjustment	103
Simulation	122
Switch output	112
System units	78
Totalizer	116
Totalizer reset	131
Showing data logging	132
Signal on alarm	192
SIMATIC PDM	62
Function	62
Spare part	179
Spare parts	179
Special connection instructions	41
Standards and guidelines	207
Status area	
For operational display	48
In the navigation view	50
Status signals	137
Storage conditions	17
Storage temperature	17
Storage temperature range	199
Structure	
Measuring device	11
Operating menu	46
Submenu	
Administration	173
Advanced setup	86
Analog inputs	81
Communication	72, 83
Configuration backup display	120
Data logging	132
Device information	173
Display	118
Events list	171

External compensation	101
Gas composition	90
Medium properties	87
Operation	131
Output values	131
Overview	47
Process variables	127
Sensor adjustment	103
Simulation	122
System units	78
Totalizer 1 to 3	116, 130
Supplementary documentation	208
Supply unit	
Requirements	34
Supply voltage	34, 195
Symbols	
For communication	48
For correction	51
For diagnostic behavior	48
For locking	48
For measured variable	48
For measurement channel number	48
For menus	50
For parameters	50
For status signal	48
For submenu	50
For wizard	50
In the status area of the local display	48
In the text and numeric editor	51
System design	
Measuring system	185
see Measuring device design	
System integration	63
<b>T</b>	
Technical data, overview	185
Temperature range	
Ambient temperature range for display	204
Storage temperature	17
Terminal assignment	32, 39
Terminals	195
Text editor	51
Thermal insulation	22
Tool tip	
see Help text	
Tools	
Electrical connection	29
Installation	24
Transport	17
Transmitter	
Connecting the signal cables	39
Turning the display module	27
Turning the housing	26
Transporting the measuring device	17
Troubleshooting	
General	135
Turning the display module	27
Turning the electronics housing	
see Turning the transmitter housing	

Turning the transmitter housing . . . . . 26

## U

Use of the measuring device

Borderline cases . . . . . 9

Incorrect use . . . . . 9

see Designated use

User interface

Current diagnostic event . . . . . 170

Previous diagnostic event . . . . . 170

User roles . . . . . 47

## V

Version data for the device . . . . . 63

Vibration resistance . . . . . 199

Vibrations . . . . . 23

## W

W@M . . . . . 177, 178, 179

W@M Device Viewer . . . . . 12, 179

Weight

Compact version . . . . . 200

SI units . . . . . 201

US units . . . . . 201, 202

Sensor remote version . . . . . 201

Transport (notes) . . . . . 17

Wizard

Define access code . . . . . 124

Display . . . . . 82

Low flow cut off . . . . . 84

Medium selection . . . . . 76

Pulse/frequency/switch output . . . . . 105, 108, 112

Workplace safety . . . . . 10

Write access . . . . . 58

Write protection

Via access code . . . . . 124

Via write protection switch . . . . . 125

Write protection switch . . . . . 125

[www.addresses.endress.com](http://www.addresses.endress.com)

---