

Operating Instructions

iTEMP TMT182B

Temperature transmitter



1 About this document

1.1 Document function

These Operating Instructions contain all the information required in the various life cycle phases of the device: from product identification, incoming acceptance and storage, to installation, connection, operation and commissioning, through to troubleshooting, maintenance and disposal.

1.2 Safety instructions (XA)

When using in hazardous areas, compliance with national regulations is mandatory. Separate Ex-specific documentation is provided for measuring systems that are used in hazardous areas. This documentation is an integral part of these Operating Instructions. The installation specifications, connection data and safety instructions it contains must be strictly observed! Make sure that you use the right Ex-specific documentation for the right device with approval for use in hazardous areas! The number of the specific Ex documentation (XA...) is provided on the nameplate. If the two numbers (on the Ex documentation and the nameplate) are identical, then you may use this Ex-specific documentation.

1.3 Symbols used

1.3.1 Safety symbols

DANGER

This symbol alerts you to a dangerous situation. Failure to avoid this situation will result in serious or fatal injury.

WARNING

This symbol alerts you to a dangerous situation. Failure to avoid this situation can result in serious or fatal injury.



CAUTION



This symbol alerts you to a dangerous situation. Failure to avoid this situation can result in minor or medium injury.

NOTICE













This symbol contains information on procedures and other facts which do not result in personal injury.

1.3.2 Electrical symbols



Symbol	Meaning
	Direct current
	Alternating current
	Direct current and alternating current

Symbol	Meaning
	Ground connection A grounded terminal which, as far as the operator is concerned, is grounded via a grounding system.
	Potential equalization connection (PE: protective earth) Ground terminals that must be connected to ground prior to establishing any other connections. The ground terminals are located on the interior and exterior of the device: <ul style="list-style-type: none"> ▪ Interior ground terminal: potential equalization is connected to the supply network. ▪ Exterior ground terminal: device is connected to the plant grounding system.

1.3.3 Symbols for certain types of information

Symbol	Meaning
	Permitted Procedures, processes or actions that are permitted.
	Preferred Procedures, processes or actions that are preferred.
	Forbidden Procedures, processes or actions that are forbidden.
	Tip Indicates additional information.
	Reference to documentation
	Reference to page
	Reference to graphic
	Notice or individual step to be observed
	Series of steps
	Result of a step
	Help in the event of a problem
	Visual inspection

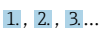
1.3.4 Symbols in graphics

Symbol	Meaning	Symbol	Meaning
1, 2, 3,...	Item numbers		Series of steps
A, B, C, ...	Views	A-A, B-B, C-C, ...	Sections
	Hazardous area		Safe area (non-hazardous area)

1.4 Tool symbols

Symbol	Meaning
 A0011219	Phillips head screwdriver

1.5 Documentation

Document	Purpose and content of the document
Technical Information TI01692T	Planning aid for your device The document contains all the technical data on the device and provides an overview of the accessories and other products that can be ordered for the device.
Brief Operating Instructions KA01605T	Guide that takes you quickly to the 1st measured value The Brief Operating Instructions contain all the essential information from incoming acceptance to initial commissioning.
Description of Device Parameters GP01197T	The document serves as a reference for parameters: it provides a detailed explanation for each individual parameter in the operating menu.



The document types listed are available:
In the Download Area of the Endress+Hauser Internet site: www.endress.com →
Download

1.6 Registered trademarks

HART®

Registered trademark of the FieldComm Group, Austin, Texas, USA

2 Basic safety instructions

2.1 Requirements for the personnel

The personnel for installation, commissioning, diagnostics and maintenance must fulfill the following requirements:

- ▶ Trained, qualified specialists must have a relevant qualification for this specific function and task.
- ▶ Are authorized by the plant owner/operator.
- ▶ Are familiar with federal/national regulations.
- ▶ Before starting work, read and understand the instructions in the manual and supplementary documentation as well as the certificates (depending on the application).
- ▶ Follow instructions and comply with basic conditions.

The operating personnel must fulfill the following requirements:

- ▶ Are instructed and authorized according to the requirements of the task by the facility's owner-operator.
- ▶ Follow the instructions in this manual.

2.2 Intended use

The device is a universal and user-configurable temperature transmitter with one sensor input for a resistance thermometer (RTD), thermocouples (TC), resistance and voltage transmitters. The head transmitter version of the device is intended for mounting in a terminal head (flat face) as per DIN EN 50446. It is also possible to mount the device on a DIN rail using the optional DIN rail clip.

If the device is used in a manner not specified by the manufacturer, the protection provided by the device may be impaired.

The manufacturer is not liable for damage caused by improper or non-intended use.

2.3 Operational safety

- ▶ Operate the device only if it is in proper technical condition, free from errors and faults.
- ▶ The operator is responsible for the interference-free operation of the device.

Hazardous area

To eliminate a danger for persons or for the facility when the device is used in the hazardous area (e.g. explosion protection or safety equipment):

- ▶ Based on the technical data on the nameplate, check whether the ordered device is permitted for the intended use in the hazardous area. The nameplate can be found on the side of the transmitter housing.
- ▶ Observe the specifications in the separate supplementary documentation that is an integral part of these instructions.

Device safety and electromagnetic compatibility

The measuring system complies with the general safety requirements as per EN 61010-1, the EMC requirements as per the IEC/EN 61326 series and the NAMUR recommendations NE 21.

NOTICE

- ▶ The device must only be powered by a power unit that operates using an energy-limited electric circuit according to UL/EN/IEC 61010-1, Section 9.4 and the requirements in Table 18.

2.4 Product safety

This product is designed in accordance with good engineering practice to meet state-of-the-art safety requirements and has been tested and left the factory in a condition in which it is safe to operate.

2.5 IT security

Our warranty is valid only if the product is installed and used as described in the Operating Instructions. The product is equipped with security mechanisms to protect it against any inadvertent changes to the settings.

IT security measures, which provide additional protection for the product and associated data transfer, must be implemented by the operators themselves in line with their security standards.

2.6 Device-specific IT security

The device offers specific functions to support protective measures by the operator. These functions can be configured by the user and guarantee greater in-operation safety if used correctly. The device provides a password for changing the user role (applies to operation via FieldCare, DeviceCare, PDM).

Function/interface	Factory setting	Recommendation
Password	Not enabled (0000)	Assign a customized access code during commissioning.
Service interface (CDI)	Enabled	On an individual basis following risk assessment.

2.6.1 User-specific password

Write access to the device parameters via the operating tool (e.g. FieldCare, DeviceCare) can be protected by a modifiable, user-specific password.

2.6.2 General information

- During commissioning, any passwords that were used at delivery should be changed.
- Follow the general rules for generating a secure password when defining and managing the password.
- The user is responsible for the management and careful handling of passwords.

3 Incoming acceptance and product identification

1. Unpack the temperature transmitter carefully. Is the packaging or content free from damage?
 - ↳ Damaged components must not be installed as the manufacturer can otherwise not guarantee compliance with the original safety requirements or the material resistance, and can therefore not be held responsible for any resulting damage.
2. Is the delivery complete or is anything missing? Check the scope of delivery against your order.
3. Does the nameplate match the ordering information on the delivery note?
4. Are the technical documentation and all other necessary documents provided? If applicable: are the Safety Instructions (e.g. XA) for hazardous areas provided?

 If one of these conditions is not satisfied, contact your Endress+Hauser Sales Center.

3.1 Product identification

The following options are available for the identification of the device:

- Nameplate specifications
- Extended order code with breakdown of the device features on the delivery note
- Enter the serial number from the nameplate in the *W@M Device Viewer* (www.endress.com/deviceviewer): All data relating to the device and an overview of the Technical Documentation supplied with the device are displayed.
- Enter the serial number on the nameplate into the *Endress+Hauser Operations App* or scan the 2-D matrix code (QR code) on the nameplate with the *Endress+Hauser Operations App*: all the information about the device and the technical documentation pertaining to the device is displayed.

3.1.1 Nameplate

The right device?

Compare and check the information on the nameplate of the device against the requirements of the measuring point.

Information on the nameplate:

- Serial number, device revision, firmware version and hardware version
- Data Matrix 2D code
- 2 lines for the TAG name and extended order code
- Approval in hazardous area with number of the relevant Ex documentation (XA...)
- Approvals with symbols

3.1.2 Name and address of manufacturer

Name of manufacturer:	Endress+Hauser Wetzer GmbH + Co. KG
Address of manufacturer:	Obere Wank 1, D-87484 Nesselwang or www.endress.com

3.2 Scope of delivery

The scope of delivery of the device comprises:

- Temperature transmitter
- Mounting material (head transmitter), optional
- Printed copy of the Brief Operating Instructions in English
- Additional documentation for devices that are suitable for use in hazardous areas, e.g. Safety instructions (XA)

3.3 Storage and transport

Dimensions: →  46

Storage temperature

- -50 to +100 °C (-58 to +212 °F)
- Humidity: max. rel. humidity: 95 % as per IEC 60068-2-30

 Pack the device for storage and transportation in such a way that it is reliably protected against impact and external influences. The original packaging offers the best protection.

Avoid the following environmental influences during storage:

- Direct sunlight
- Vibration
- Aggressive media

4 Mounting

4.1 Mounting requirements

4.1.1 Dimensions

For the device dimensions, see the 'Technical data' → 46.

4.1.2 Mounting location

In the terminal head, flat face, as per DIN EN 50446, direct mounting on insert with cable entry (middle hole 7 mm).

i Make sure there is enough space in the terminal head!

It is also possible to mount the head transmitter on a DIN rail as per IEC 60715 using the DIN rail clip → 33 accessory.

For information about the conditions (such as the ambient temperature, degree of protection, climate class etc.) that must be present at the installation point so that the device can be mounted correctly, see the 'Technical data' section → 46.

When using in hazardous areas, the limit values of the certificates and approvals must be observed (see Ex Safety Instructions).

4.2 Mounting the device

A Phillips head screwdriver is required to mount the head transmitter:

- Maximum torque for securing screws = 1 Nm ($\frac{3}{4}$ foot-pound), screwdriver: Pozidriv Z2
- Maximum torque for screw terminals = 0.35 Nm ($\frac{1}{4}$ foot-pound), screwdriver: Pozidriv Z1

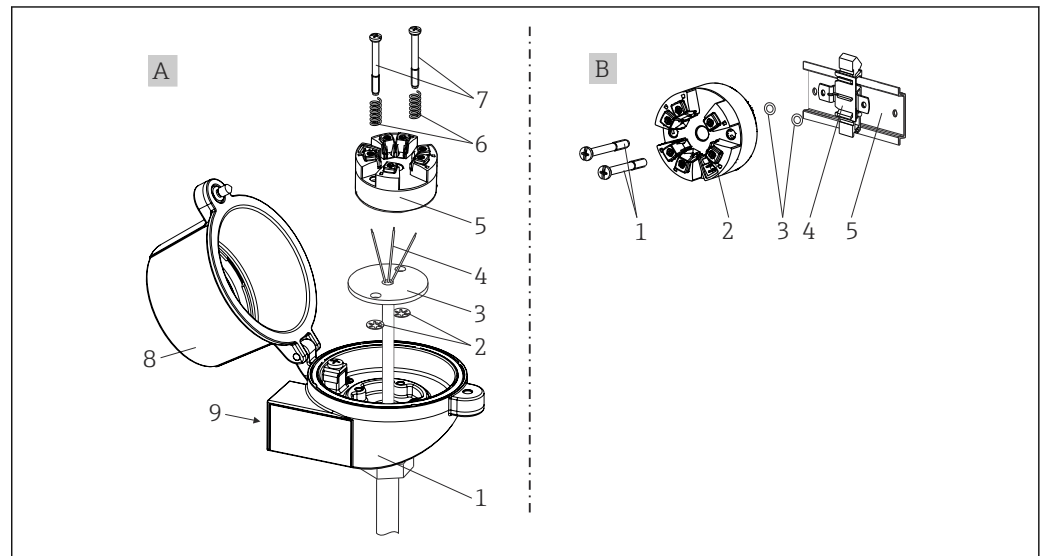

1 Head transmitter mounting

A0046845

A	Mounting in a terminal head (terminal head flat face as per DIN 43729)
1	Terminal head
2	Snap rings
3	Insert

A	Mounting in a terminal head (terminal head flat face as per DIN 43729)
4	Connection wires
5	Head transmitter
6	Mounting springs
7	Mounting screws
8	Terminal head cover
9	Cable entry

Procedure for mounting in a terminal head, item A:

1. Open the terminal head cover (8) on the terminal head.
2. Guide the connection wires (4) of the insert (3) through the center hole in the head transmitter (5).
3. Fit the mounting springs (6) on the mounting screws (7).
4. Guide the mounting screws (7) through the side boreholes of the head transmitter and the insert (3). Fix both mounting screws with the snap rings (2).
5. Tighten the head transmitter (5) along with the insert (3) in the terminal head.
6. After wiring, close the terminal head cover (8) tightly again.

B	Mounting on DIN rail (DIN rail as per IEC 60715)
1	Mounting screws
2	Head transmitter
3	Snap rings
4	DIN rail clip
5	DIN rail

Procedure for mounting on a DIN rail, item B:

1. Press the DIN rail clip (4) onto the DIN rail (5) until it engages with a click.
2. Guide the mounting screws (1) through the side boreholes of the head transmitter (2). Then fix both mounting screws with the snap rings (3).
3. Screw the head transmitter (2) onto the DIN rail clip (4).

4.2.1 Mounting typical of North America

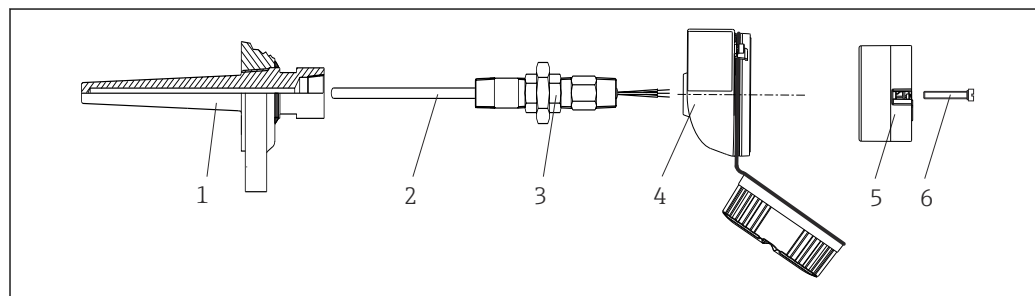

A0008520

2 Head transmitter mounting

- 1 Thermowell
- 2 Insert
- 3 Adapter, coupling
- 4 Terminal head
- 5 Head transmitter
- 6 Mounting screws

Structure of thermometer with RTD sensors and head transmitter:

1. Fit the thermowell (1) on the process pipe or the container wall. Secure the thermowell according to the instructions before the process pressure is applied.
2. Fit the necessary neck tube nipples and adapter (3) on the thermowell.
3. Make sure sealing rings are installed if such rings are needed for harsh environmental conditions or special regulations.
4. Guide the mounting screws (6) through the side boreholes of the head transmitter (5).
5. Position the head transmitter (5) in the terminal head (4) in such a way that the power supply lines (terminals 1 and 2) point to the cable entry.
6. Using a screwdriver, screw down the head transmitter (5) in the terminal head (4).
7. Guide the connection wires of the insert (3) through the lower cable entry of the terminal head (4) and through the middle hole in the head transmitter (5). Wire the connection wires up to the transmitter .
8. Screw the terminal head (4), with the integrated and wired head transmitter, onto the ready-mounted nipple and adapter (3).

NOTICE

The terminal head cover must be secured properly to meet the requirements for explosion protection.

- ▶ After wiring, securely screw the terminal head cover back on.

4.3 Post-mounting check

After installing the device, carry out the following checks:

Device condition and specifications	Notes
Are the device, the connections and connecting cables free of damage (visual inspection)?	-
Do the ambient conditions match the device specification (e.g. ambient temperature, measuring range, etc.)?	See the 'Technical data' section
Have connections been established correctly and with the specified torque?	-

5 Electrical connection

⚠ CAUTION

- ▶ Switch off the power supply before installing or connecting the device. Failure to observe this may result in the destruction of parts of the electronics.
- ▶ Do not occupy the CDI interface. An incorrect connection can destroy the electronics.

NOTICE

Do not overtighten the screw terminals, as this could damage the transmitter.

- ▶ Maximum tightening torque = 1 Nm ($\frac{3}{4}$ lbf ft).

5.1 Connecting requirements

A Phillips head screwdriver is required to wire the head transmitter with screw terminals.

Proceed as follows to wire a mounted head transmitter:

1. Open the cable gland and the housing cover on the terminal head or the field housing.
2. Feed the cables through the opening in the cable gland.
3. Connect the cables as shown in →  12.
4. Tighten the cable gland again and close the housing cover.

In order to avoid connection errors always follow the instructions in the post-connection check section before commissioning!

5.2 Connecting the sensor cables

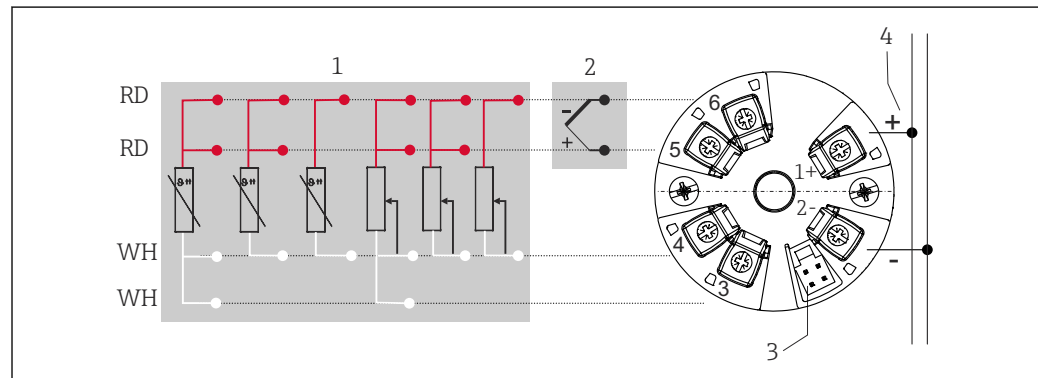

 3 Assignment of terminal connections for head transmitter

- 1 Sensor input, RTD and Ω , 4-, 3- and 2-wire
- 2 Sensor input, TC and mV
- 3 CDI interface
- 4 Bus terminator and power supply

A minimum load of 250 Ω is required in the signal circuit in order to operate the HART[®] transmitter via the HART[®] protocol (terminals 1 and 2).

NOTICE

- ▶  ESD – Electrostatic discharge. Protect the terminals from electrostatic discharge. Failure to observe this may result in the destruction or malfunction of parts of the electronics.

5.3 Connecting the transmitter

i Cable specification

- A normal device cable suffices if only the analog signal is used.
- A shielded cable is recommended for HART® communication. Observe grounding concept of the plant.

Also observe the general procedure on → 12.

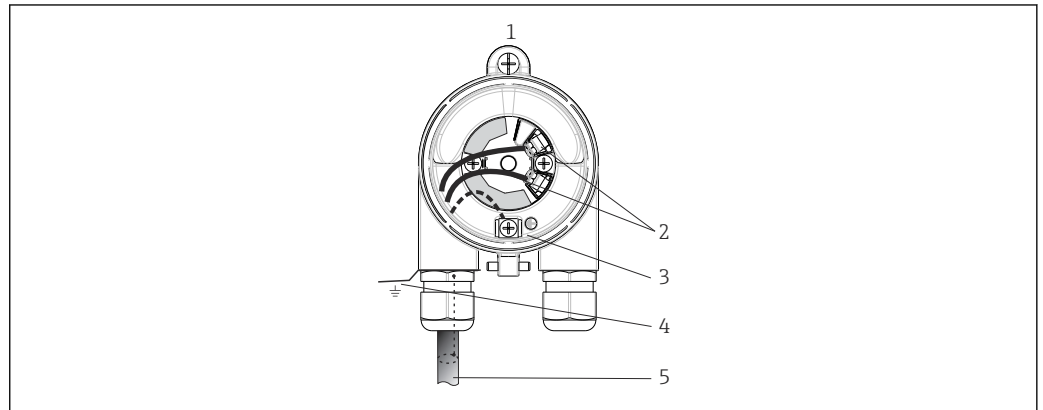

A0050721

i 4 Connecting the signal cables and power supply

- 1 Head transmitter installed in the terminal head or field housing
- 2 Terminals for HART® protocol and power supply
- 3 Internal ground connection
- 4 External ground connection
- 5 Shielded signal cable (recommended for HART® protocol)

- The terminals for connecting the signal cable (1+ and 2-) are protected against reverse polarity.
- Cable cross-section max. 1.5 mm²

5.4 Special connection instructions

Shielding and grounding

The specifications of the FieldComm Group™ must be observed when installing a HART® transmitter.

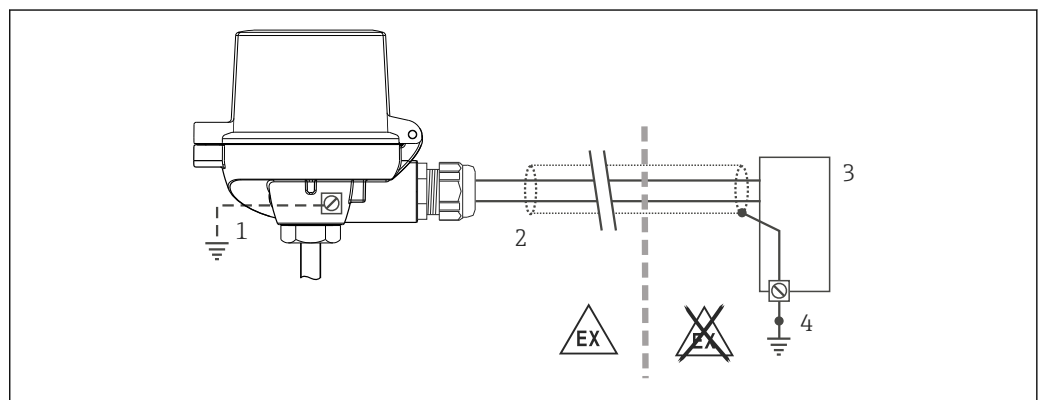





A0014463

i 5 Shielding and grounding the signal cable at one end with HART® communication

- 1 Optional grounding of the field device, isolated from cable shielding
- 2 Grounding of the cable shield at one end
- 3 Supply unit
- 4 Grounding point for HART® communication cable shield

5.5 Ensuring the degree of protection

Compliance with the following points is mandatory following installation in the field or servicing in order to ensure that IP67 protection is maintained:

- The transmitter must be mounted in a terminal head with the appropriate degree of protection.
- The housing seals must be clean and undamaged when inserted into their grooves. The seals must be dried, cleaned or replaced if necessary.
- The connecting cables used must have the specified external diameter (e.g. M20x1.5, cable diameter 8 to 12 mm).
- Firmly tighten the cable gland. →  6,  14
- The cables must loop down before they enter the cable glands ("water trap"). This means that any moisture that may form cannot enter the gland. Install the device in such a way that the cable glands are not facing upwards. →  6,  14
- Replace unused cable glands with dummy plugs.
- Do not remove the grommet from the cable gland.

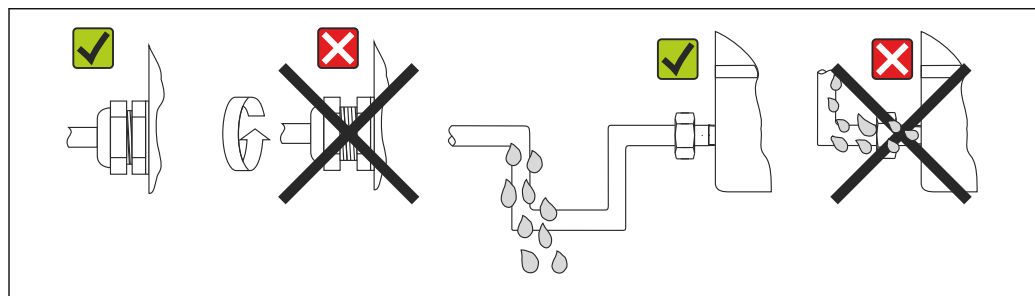

A0024523

 6 Connection tips to retain IP67 protection

5.6 Post-connection check

Device condition and specifications	Notes
Is the device or cable undamaged (visual check)?	--
Electrical connection	Notes
Does the supply voltage match the specifications on the nameplate?	<ul style="list-style-type: none"> ■ Head transmitter: $U = 10$ to $36 V_{DC}$ ■ Other values apply in the hazardous area, see the corresponding Ex Safety Instructions (XA).
Are the mounted cables relieved of tension?	--
Are the power supply and signal cables connected correctly?	→  12
Are all of the screw terminals well-tightened?	--
Are all the cable entries mounted, tightened and leak-tight?	--
Are all housing covers installed and firmly tightened?	--

6 Operation options

6.1 Overview of operation options

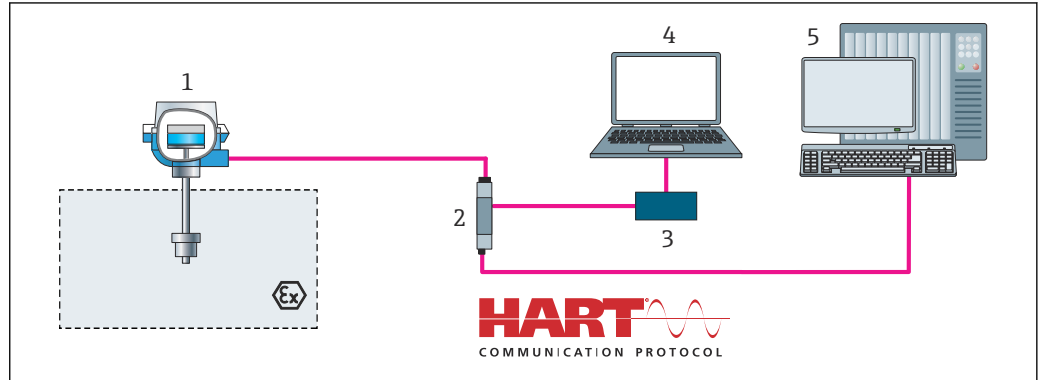

7 Operation options for the transmitter via HART® communication

- 1 Temperature transmitter
- 2 Transmitter active barrier with bidirectional HART® signal transmission
- 3 HART® modem
- 4 PC, laptop or tablet with FieldCare/DeviceCare operating tools
- 5 PLC

6.2 Structure and function of the operating menu

6.2.1 Structure of the operating menu

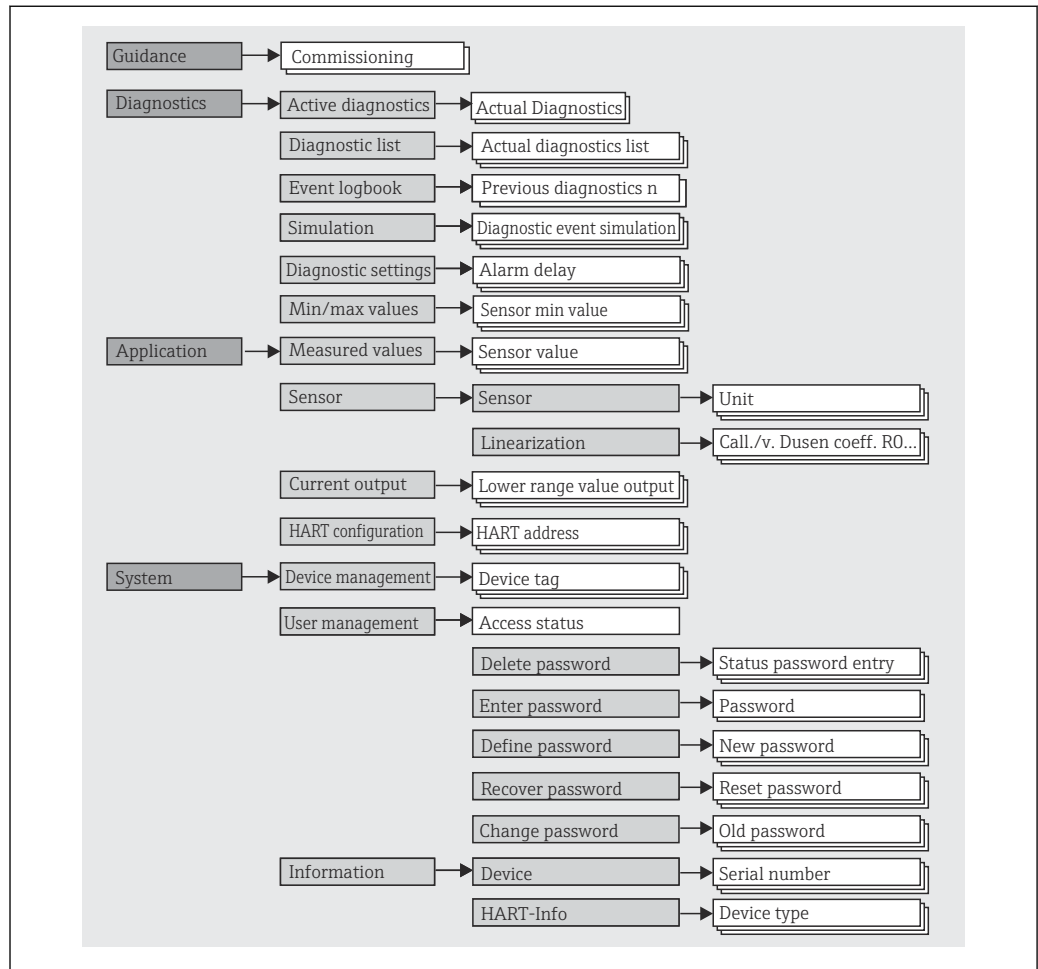

A0051066

User roles

Endress+Hauser's role-based access concept consists of two hierarchical levels for the user and presents the various user roles with defined read/write authorizations derived from the NAMUR shell model.

- **Operator**

The plant operator can only change settings that do not affect the application - and particularly the measuring path - and simple, application-specific functions that are used during operation. The operator is able to read all the parameters, however.

- **Maintenance**

The **Maintenance** user role refers to configuration situations: commissioning and process adaptations as well as troubleshooting. It allows the user to configure and modify all available parameters. In contrast to the **Operator** user role, in the Maintenance role the user has read and write access to all the parameters.

- **Changing the user role**

A user role - and therefore existing read and write authorization - is changed by selecting the desired user role (already pre-selected depending on the operating tool) and entering the correct password when subsequently prompted. When a user logs out, system access always returns to the lowest level in the hierarchy. A user is logged out either by actively selecting the logout function when operating the device or is logged out automatically if the device is not operated for a period of over 600 seconds. Irrespective of this, actions that are already in progress (e.g. active upload/download, data logging, etc.) continue to be executed in the background.

- **As-delivered state**

The **Operator** user role is not enabled when the device is delivered from the factory, i.e. the **Maintenance** role is the lowest level in the hierarchy ex-works. This state makes it possible to commission the device and make other process adaptations without having to enter a password. Afterwards, a password can be assigned for the **Maintenance** user role to protect this configuration. The **Operator** user role is not visible when the device is delivered from the factory.

- **Password**

The **Maintenance** user role can assign a password in order to restrict access to device functions. This activates the **Operator** user role, which is now the lowest hierarchy level where the user is not asked to enter a password. The password can only be changed or disabled in the **Maintenance** user role. A password can be defined at different points in the operation of the device:

In the menu: Guidance → Commissioning wizard: as part of guided device operation

In the menu: System → User management

Submenus

Menu	Typical tasks	Content/meaning
"Diagnostics"	<p>Troubleshooting:</p> <ul style="list-style-type: none"> ▪ Diagnosing and eliminating process errors. ▪ Error diagnostics in difficult cases. ▪ Interpretation of device error messages and correcting associated errors. 	<p>Contains all parameters for detecting and analyzing errors:</p> <ul style="list-style-type: none"> ▪ Diagnostic list Contains up to 3 error messages currently pending ▪ Event logbook Contains the last 10 error messages ▪ "Simulation" submenu Used to simulate measured values, output values or diagnostic messages ▪ "Diagnostic settings" submenu Contains all the parameters for configuring error events ▪ "Min/max values" submenu Contains the minimum/maximum indicator and the reset option
"Application"	<p>Commissioning:</p> <ul style="list-style-type: none"> ▪ Configuration of the measurement. ▪ Configuration of data processing (scaling, linearization, etc.). ▪ Configuration of the analog measured value output. <p>Tasks during operation: Reading measured values.</p>	<p>Contains all parameters for commissioning:</p> <ul style="list-style-type: none"> ▪ "Measured values" submenu Contains all the current measured values ▪ "Sensor" submenu Contains all the parameters for configuring the measurement ▪ "Output" submenu Contains all the parameters for configuring the analog current output ▪ "HART configuration" submenu Contains the settings and the most important parameters for HART communication
"System"	<p>Tasks that require detailed knowledge of the system administration of the device:</p> <ul style="list-style-type: none"> ▪ Optimum adaptation of the measurement for system integration. ▪ Detailed configuration of the communication interface. ▪ User and access administration, password control ▪ Information for device identification and HART information. 	<p>Contains all the higher-level device parameters that are assigned for system, device and user management, including Bluetooth configuration.</p> <ul style="list-style-type: none"> ▪ "Device management" submenu Contains parameters for general device management ▪ "Device and user management" submenus Parameters for access authorization, password assignment, etc. ▪ "Information" submenu Contains all the parameters for the unique identification of the device ▪ "Display" submenu Configuration of the display

6.3 Access to the operating menu via the operating tool

The Endress+Hauser FieldCare and DeviceCare operating tools are available to download (<https://www.software-products.endress.com>) or can be found on the data storage medium, which you can obtain from your local Endress+Hauser Sales Center.

6.3.1 DeviceCare

Function scope

DeviceCare is a free configuration tool for Endress+Hauser devices. It supports devices with the following protocols, provided a suitable device driver (DTM) is installed: HART, PROFIBUS, FOUNDATION Fieldbus, Ethernet/IP, Modbus, CDI, ISS, IPC and PCP. The target group comprises customers without a digital network in plants and service centers as well as Endress+Hauser service technicians. The devices can be connected directly via a modem (point-to-point) or a bus system. DeviceCare is fast, easy and intuitive to use. It can run on a PC, laptop or tablet with a Windows operating system.

Source for device description files

See information in the "System integration" section →  22

Establishing a connection

Example: CDI communication kit FXA291 (USB)

1. Make sure that the DTM library is updated for all the connected devices.
 2. Start DeviceCare and connect the device via the **Automatic** button.
 - ↳ The device is detected automatically.
- i** When transmitting the device parameters following offline parameter configuration, the password for **Maintenance** must first be entered in the **System -> User administration** menu, if specified.

User interface

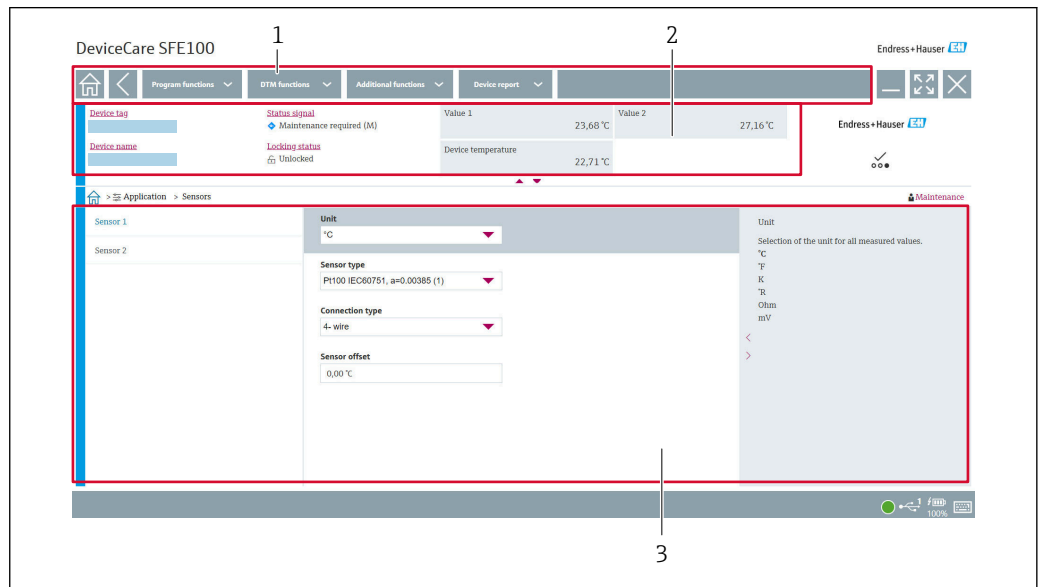

8 DeviceCare user interface with device information

- 1 Navigation area
- 2 Displays device name, current status, current measured values
- 3 Device parameter configuration section

6.3.2 FieldCare

Function scope

FDT/DTM-based plant asset management tool from Endress+Hauser. It can configure all smart field units in a system and helps you manage them. By using the status information, it is also a simple but effective way of checking their status and condition. Access is via the HART® protocol, CDI (= Endress+Hauser Common Data Interface). It supports devices with the following protocols, provided a suitable device driver (DTM) is installed: HART, PROFIBUS, FOUNDATION Fieldbus, Ethernet/IP, Modbus, CDI, ISS, IPC and PCP.

Typical functions:

- Parameterization of transmitters
- Loading and saving of device data (upload/download)
- Documentation of the measuring point
- Visualization of the measured value memory (line recorder) and event logbook



For details, see Operating Instructions BA027S/04/xx and BA059AS/04/xx

Source for device description files

See information → 22

Establishing a connection

Example: CDI communication kit FXA291 (USB)

1. Make sure that the DTM library is updated for all the connected devices.
 2. Start FieldCare and create a project.
 3. Right-click **Host PC** Add device...
 - ↳ The **Add new device** window opens.
 4. Select the **CDI Communication FXA291** option from the list and press **OK** to confirm.
 5. Double-click **CDI Communication FXA291** DTM.
 - ↳ Check whether the correct modem is connected to the serial interface connection.
 6. Right-click **CDI Communication FXA291** and in the context menu select the **Create network** option.
 - ↳ The connection to the device is established.
- i** When transmitting the device parameters following offline parameter configuration, the password for **Maintenance** must first be entered in the **System -> User administration** menu, if specified.

User interface

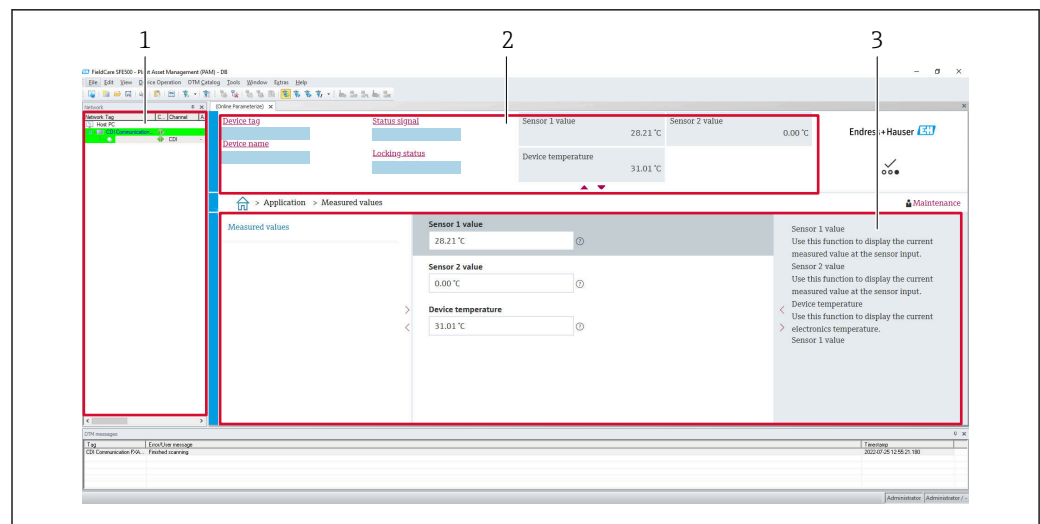

A0050411

9 FieldCare user interface with device information

- 1 Network view
- 2 Displays device name, current status, current measured values
- 3 Menu navigation, device parameterization, help section

6.3.3 AMS Device Manager

Function scope

Program from Emerson Process Management for operating and configuring measuring devices via the HART® protocol.

Source for device description files

See information → **22**.

6.3.4 SIMATIC PDM

Function scope

SIMATIC PDM is a standardized, vendor-independent program from Siemens for the operation, configuration, maintenance and diagnosis of intelligent field devices via the HART® protocol.

Source for device description files

See information →  22.

7 System integration

7.1 Overview of device description files

Version data for the device

Firmware version	01.01.zz	<ul style="list-style-type: none"> ▪ On the title page of the manual ▪ On the nameplate ▪ Firmware version parameter System → Information → Device → Firmware version
Manufacturer ID	0x11	Manufacturer ID parameter System → Information → HART info → Manufacturer ID
Device type ID	0x11D2	Device type parameter System → Information → HART info → Device type
HART protocol revision	7	---
Device revision	1	<ul style="list-style-type: none"> ▪ On the transmitter nameplate ▪ Device revision parameter System → Information → HART info → Device revision

The suitable device driver software (DD/DTM) for the individual operating tools can be obtained from different sources:

- www.endress.com --> Downloads --> Search field: Software --> Software type: Device drivers
- www.endress.com --> Products: Individual product page, e.g. TMTxy --> Documents/Manuals/Software: Electronic Data Description (EDD) or Device Type Manager (DTM).

Endress+Hauser supports all common operating tools from a variety of manufacturers (e.g. Emerson Process Management, ABB, Siemens, Yokogawa, Honeywell and many others). Endress+Hauser's FieldCare and DeviceCare operating tools are also available for download (www.endress.com --> Downloads --> Search field: Software --> Application software) or on the data storage medium which you can obtain from your local Endress+Hauser sales organization.

7.2 Measured variables via HART protocol

The following measured values are assigned to the device variables at the factory:

Device variable	Measured value
Primary device variable (PV)	Sensor 1
Secondary device variable (SV)	Device temperature
Tertiary device variable (TV)	Sensor 1
Quaternary device variable (QV)	Sensor 1

7.3 Supported HART® commands

 The HART® protocol enables the transfer of measuring data and device data between the HART® master and the field device for configuration and diagnostics purposes. HART® masters such as the handheld terminal or PC-based operating programs (e.g. FieldCare) need device description files (DD, DTM) which are used to access all the information in a HART® device. This information is transmitted exclusively via "commands".

There are three different types of command

- Universal commands:

All HART® devices support and use universal commands. These are associated with the following functionalities for example:

- Recognition of HART® devices
- Reading digital measured values

- Common practice commands:

Common practice commands offer functions which are supported and can be executed by many but not all field devices.

- Device-specific commands:

These commands allow access to device-specific functions which are not HART® standard. Such commands access individual field device information, among other things.



Command No.	Description
Universal commands	
0, Cmd0	Read unique identifier
1, Cmd001	Read primary variable
2, Cmd002	Read loop current and percent of range
3, Cmd003	Read dynamic variables and loop current
6, Cmd006	Write polling address
7, Cmd007	Read loop configuration
8, Cmd008	Read dynamic variable classifications
9, Cmd009	Read device variables with status
11, Cmd011	Read unique identifier associated with TAG
12, Cmd012	Read message
13, Cmd013	Read TAG, descriptor, date
14, Cmd014	Read primary variable transducer information
15, Cmd015	Read device information
16, Cmd016	Read final assembly number
17, Cmd017	Write message
18, Cmd018	Write TAG, descriptor, date
19, Cmd019	Write final assembly number
20, Cmd020	Read long TAG (32-byte TAG)
21, Cmd021	Read unique identifier associated with long TAG
22, Cmd022	Write long TAG (32-byte TAG)
38, Cmd038	Reset configuration changed flag
48, Cmd048	Read additional device status
Common practice commands	
33, Cmd033	Read device variables
34, Cmd034	Write primary variable damping value
35, Cmd035	Write primary variable range values
40, Cmd040	Enter/Exit fixed current mode
42, Cmd042	Perform device reset
44, Cmd044	Write primary variable units
45, Cmd045	Trim loop current zero
46, Cmd046	Trim loop current gain

Command No.	Description
50, Cmd050	Read dynamic variable assignments
54, Cmd054	Read device variable information
59, Cmd059	Write number of response preambles
72, Cmd072	Squawk
95, Cmd095	Read Device Communication Statistics
100, Cmd100	Write Primary Variable Alarm Code
516, Cmd516	Read Device Location
517, Cmd517	Write Device Location
518, Cmd518	Read Location Description
519, Cmd519	Write Location Description
520, Cmd520	Read Process Unit Tag
521, Cmd521	Write Process Unit Tag
523, Cmd523	Read Condensed Status Mapping Array
524, Cmd524	Write Condensed Status Mapping Array
525, Cmd525	Reset Condensed Status Mapping Array
526, Cmd526	Write Simulation Mode
527, Cmd527	Simulate Status Bit

8 Commissioning

8.1 Post-installation check

Before commissioning the measuring point make sure that all final checks have been carried out:

- "Post-installation check" checklist →  11
- "Post-connection check" checklist →  14

8.2 Switching on the transmitter

Once you have completed the post-connection checks, switch on the supply voltage. The transmitter performs a number of internal test functions after power-up.

The device works after approx. 7 seconds. Normal measuring mode commences as soon as the switch-on procedure is completed.

8.3 Configuring the measuring device

Wizards

The starting point for device wizards is in the **Guidance** menu. Wizards not only query individual parameters but also guide the user through the configuration and/or verification of entire sets of parameters with step-by-step instructions, including questions, that are comprehensible for the user. The "Start" button can be disabled for wizards that require specific access authorization (lock symbol appears on the screen).

The following five operating elements are supported for navigation in the wizards:

- **Start**
Only on the initial page: start the wizard and go to the first section
- **Next**
Go to the next page of the wizard. Is not enabled until parameters are entered or confirmed.
- **Back**
Return to the previous page
- **Cancel**
If Cancel is selected, the status before the wizard was started is restored
- **Finish**
Closes the wizard and possibility of making additional parameter settings on the device. Only enabled on the final page.

8.3.1 Commissioning wizard

Commissioning is the first step towards using the device for the designated application. The Commissioning wizard contains an introductory page (with the "Start" operating element) and a short description of the content. The wizard consists of several sections in which the user is guided step-by-step through the commissioning of the device.

"Device management" is the first section that appears when the user runs the wizard, and contains the following parameters. Its main purpose is to provide information about the device:

Navigation  **Guidance → Commissioning → Start**



A0037378-EN

Device TAG
 Device name
 Serial number
 Extended order code (n)¹⁾

1) n = placeholder for 1, 2, 3

The second section, "Sensor", takes the user through all the relevant settings for the sensor. The number of parameters displayed depends on the corresponding settings. The following parameters can be configured:

Navigation  **Guidance → Commissioning → Sensor**

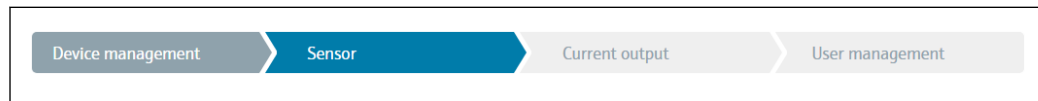

A0037389-EN

Unit
 Sensor type
 Connection type
 2-wire compensation
 Reference junction
 RJ preset value

In the third section, the settings are made for the analog output and the output's alarm response. The following parameters can be configured:

Navigation  **Guidance → Commissioning → Current output**

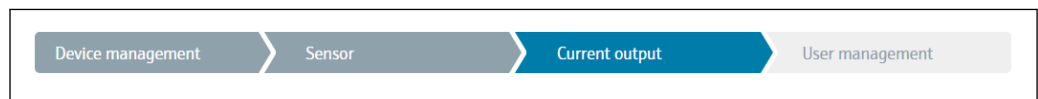

A0037390-EN

4 mA value
 20 mA value
 Failure mode

In the final section, a password can be defined for the "Maintenance" user role. This is strongly recommended to protect the device against unauthorized access. The following steps describe how to configure a password for the "Maintenance" role for the first time.

Navigation  **Guidance → Commissioning → User management**



A0037391-EN

Access status
 New password
 Confirm new password

1. The **Maintenance** role appears in the "Access status" picklist.
 - ↳ Afterwards, the **New password** and **Confirm new password** input boxes appear.

2. Enter a user-defined password that meets the password rules indicated in the online help.
3. Enter the password again in the **Confirm new password** input box.

Once the password has been entered successfully, parameter changes, particularly those that are needed for commissioning, process adaptation/optimization and troubleshooting, can only be implemented in the **Maintenance** user role and if the password is entered successfully.

8.4 Protecting settings from unauthorized access

By assigning a password for the **Maintenance** user role, on the software side it is possible to restrict access authorization and protect the device against unauthorized access.

 See the Commissioning wizard →  25

The parameters are also protected against modification by logging out of the **Maintenance** user role and switching to the **Operator** role.



To disable the write protection, the user must log on with the **Maintenance** user role via the relevant operating tool.

 User role concept →  16

9 Diagnostics and troubleshooting

9.1 General troubleshooting

Always start troubleshooting with the checklists below if faults occur after startup or during operation. The checklists take you directly (via various queries) to the cause of the problem and the appropriate remedial measures.

 Due to its design, the device cannot be repaired. However, it is possible to send the device in for examination. See the information in the "Return" section. →  32

General errors

Problem	Possible cause	Remedy
Device is not responding.	Supply voltage does not match the voltage specified on the nameplate.	Check the voltage at the transmitter directly using a voltmeter and correct.
	Connecting cables are not in contact with the terminals.	Ensure electrical contact between the cable and the terminal.
	Electronics unit is defective.	Replace the device.
Output current < 3.6 mA	Signal line is not wired correctly.	Check wiring.
	Electronics unit is defective.	Replace the device.
HART® communication is not working.	Missing or incorrectly installed communication resistor.	Install the communication resistor (250 Ω) correctly.
	Commubox is connected incorrectly.	Connect Commubox correctly.
	Commubox is not set to "HART®".	Set Commubox selector switch to "HART®".



Error messages in the configuration software
→  29



Application errors without status messages for RTD sensor connection

Problem	Possible cause	Remedy
Measured value is incorrect/inaccurate	Incorrect sensor orientation.	Install the sensor correctly.
	Heat conducted by sensor.	Observe the installed length of the sensor.
	Device programming is incorrect (number of wires).	Change the Connection type device function.
	Device programming is incorrect (scaling).	Change scaling.
	Incorrect RTD configured.	Change the Sensor type device function.
	Sensor connection.	Check that the sensor is connected correctly.
	The cable resistance of the sensor (2-wire) was not compensated.	Compensate the cable resistance.
Failure current (≤ 3.6 mA or ≥ 21 mA)	Offset incorrectly set.	Check offset.
	Faulty sensor.	Check the sensor.

Problem	Possible cause	Remedy
	RTD connected incorrectly.	Connect the connecting cables correctly (terminal diagram).
	Device programming is incorrect (e.g. number of wires).	Change the Connection type device function.
	Incorrect programming.	Incorrect sensor type set in the Sensor type device function. Set the correct sensor type.



Application errors without status messages for TC sensor connection

Problem	Possible cause	Remedy
Measured value is incorrect/ inaccurate	Incorrect sensor orientation.	Install the sensor correctly.
	Heat conducted by sensor.	Observe the installed length of the sensor.
	Device programming is incorrect (scaling).	Change scaling.
	Incorrect thermocouple type (TC) configured.	Change the Sensor type device function.
	Incorrect reference junction set.	Set the correct reference junction.
	Interference via the thermocouple wire welded in the thermowell (interference voltage coupling).	Use a sensor where the thermocouple wire is not welded.
	Offset incorrectly set.	Check offset.
Failure current (≤ 3.6 mA or ≥ 21 mA)	Faulty sensor.	Check the sensor.
	Sensor is connected incorrectly.	Connect the connecting cables correctly (terminal diagram).
	Incorrect programming.	Incorrect sensor type set in the Sensor type device function. Set the correct sensor type.

9.2 Diagnostic information via communication interface

Status signals

Letter/ symbol ¹⁾	Event category	Meaning
F	Operating error	An operating error has occurred.
C	Service mode	The device is in the service mode (e.g. during a simulation).
S	Out of specification	The device is being operated outside its technical specifications (e.g. during startup or cleaning processes).
M	Maintenance required	Maintenance is required.
N -	Not categorized	

1) As per NAMUR NE107

Diagnostic behavior

Alarm	Measurement is interrupted. The signal outputs adopt the defined alarm state. A diagnostic message is generated.
Warning	The device continues to measure. A diagnostic message is generated.
Disabled	The diagnosis is completely disabled even if the device is not recording a measured value.

9.3 Pending diagnostic messages

If two or more diagnostic events occur simultaneously, only the diagnostic message with the highest priority is shown. Additional pending diagnostic messages are shown in the **Diagnostic list** submenu. The status signal dictates the priority in which the diagnostic messages are displayed. The following order of priority applies: F, C, S, M. If two or more diagnostic events with the same status signal are active simultaneously, the numerical order of the event number dictates the order of priority in which the events are displayed, e.g.: F042 appears before F044 and before S044.

9.4 Diagnostic list

All the diagnostic messages that are currently queued can be displayed in the **Diagnostic list** submenu.

Navigation path

Diagnostics → Diagnostic list

Diagnostic number	Short text	Remedy instructions	Status signal [from the factory]	Diagnostic behavior [from the factory]
Diagnostic of sensor				
041	Sensor interrupted	1. Check electrical connection 2. Replace sensor 1 3. Check connection type	F	Alarm
043	Short circuit	1. Check electrical connection 2. Check sensor 3. Replace sensor or cable	F	Alarm
047	Sensor limit reached	1. Check sensor 2. Check process conditions	S	Warning
Diagnostic of electronic				
145	Compensation reference point	1. Check terminal temperature 2. Check external reference point	F	Alarm
201	Electronics faulty	1. Restart device 2. Replace electronics	F	Alarm
221	Reference sensor defective	Replace device	M	Alarm
Diagnostic of configuration				
401	Factory reset active	Factory reset in progress, please wait	C	Warning
402	Initialization active	Initialization in progress, please wait	C	Warning
402	Initialization active		C	Warning
410	Data transfer failed	1. Check connection 2. Repeat data transfer	F	Alarm

Diagnostic number	Short text	Remedy instructions	Status signal [from the factory]	Diagnostic behavior [from the factory]
411	Up-/download active	Up-/download in progress, please wait	C	Warning
435	Linearization faulty	Check linearization	F	Alarm
485	Process variable simulation active	Deactivate simulation	C	Warning
491	Output simulation	Deactivate simulation	C	Warning
495	Diagnostic event simulation active	Deactivate simulation	C	Warning
531	Factory adjustment missing	1. Contact service organization 2. Replace device	F	Alarm
537	Configuration	1. Check device configuration 2. Up- and download new configuration	F	Alarm
537	Configuration	Check current output configuration	F	Alarm
582	Sensor diagnostics TC deactivated	Switch on diagnostics for thermocouple measurement	C	Warning
Diagnostic of process				
801	Supply voltage too low	Increase supply voltage	S	Alarm
825	Operating temperature	1. Check ambient temperature 2. Check process temperature	S	Warning
844	Process value out of specification	1. Check process value 2. Check application 3. Check sensor	S	Warning

9.5 Event logbook

 Previous diagnostic messages are displayed in the **Event logbook** submenu.

9.6 Firmware history

Revision history

The firmware version (FW) on the nameplate and in the Operating Instructions indicates the device release: XX.YY.ZZ (example 01.02.01).

- XX Change to main version. No longer compatible. The device and Operating Instructions change.
- YY Change to functions and operation. Compatible. The Operating Instructions change.
- ZZ Fixes and internal changes. No changes to the Operating Instructions.

Date	Firmware version	Changes	Documentation
12/2022	01.01.zz	Original firmware	BA02260T, Version 01.22

10 Maintenance

No special maintenance work is required for the device.

Cleaning

A clean, dry cloth can be used to clean the device.

11 Repair

11.1 General notes

Due to the device's design and construction, it cannot be repaired.

11.2 Spare parts

Device spare parts that are currently available can be found online at: http://www.products.endress.com/spareparts_consumables. Always quote the serial number of the device when ordering spare parts!

Type	Order number
Standard - DIN mounting set (2 screws and springs, 4 lock washers, 1 CDI connector cover)	71044061
US - M4 mounting set (2 screws and 1 CDI connector cover)	71044062

11.3 Return

The requirements for safe device return can vary depending on the device type and national legislation.

1. Refer to the website for more information: <http://www.endress.com/support/return-material>
2. Return the device if repairs or a factory calibration are required, or if the wrong device was ordered or delivered.

11.4 Disposal



If required by the Directive 2012/19/EU on waste electrical and electronic equipment (WEEE), our products are marked with the depicted symbol in order to minimize the disposal of WEEE as unsorted municipal waste. Such products may not be disposed of as unsorted municipal waste and can be returned to Endress+Hauser for disposal at conditions stipulated in our General Terms and Conditions or as individually agreed.

12 Accessories

Various accessories, which can be ordered with the device or subsequently from Endress+Hauser, are available for the device. Detailed information on the order code in question is available from your local Endress+Hauser sales center or on the product page of the Endress+Hauser website: www.endress.com.





Accessories included in the scope of delivery:

- Printed version of Brief Operating Instructions in English
- ATEX supplementary documentation: ATEX Safety instructions (XA), Control Drawings (CD)
- Mounting material for head transmitter

12.1 Device-specific accessories



Accessories for the head transmitter
Field housing TA30x for Endress+Hauser head transmitter
Adapter for DIN rail mounting, clip as per IEC 60715 (TH35) without securing screws
Standard - DIN mounting kit (2 screws + springs, 4 securing disks and 1 display connector cover)
US - M4 securing screws (2 M4 screws and 1 display connector cover)

12.2 Communication-specific accessories

Accessories	Description
Commubox FXA195 HART	For intrinsically safe HART® communication with FieldCare via the USB interface.  For details, see Technical Information TI404F/00
Commubox FXA291	Connects Endress+Hauser field devices with a CDI interface (= Endress+Hauser Common Data Interface) and the USB port of a computer or laptop.  For details, see Technical Information TI405C/07
WirelessHART adapter	Is used for the wireless connection of field devices. The WirelessHART® adapter can be easily integrated into field devices and existing infrastructures, offers data protection and transmission safety and can be operated in parallel with other wireless networks.  For details, see Operating Instructions BA061S/04
Field Xpert SMT70, SMT77	Universal, high-performance tablet PC for device configuration The tablet PC enables mobile plant asset management in hazardous (Ex-Zone-1) and non-hazardous areas. It is suitable for commissioning and maintenance staff to manage field instruments with a digital communication interface and to record progress. This tablet PC is designed as a comprehensive, all-in-one solution. With a pre-installed driver library, it is an easy-to-use, touch-sensitive tool which can be used to manage field instruments throughout their entire life cycle.  For details: <ul style="list-style-type: none"> ▪ SMT70 - Technical Information TI01342S ▪ SMT77 - Technical Information TI01418S

12.3 Service-specific accessories

Accessories	Description
Applicator	Software for selecting and sizing Endress+Hauser measuring devices: <ul style="list-style-type: none"> ▪ Calculation of all the necessary data for identifying the optimum measuring device: e.g. pressure loss, accuracy or process connections. ▪ Graphic illustration of the calculation results Administration, documentation and access to all project-related data and parameters over the entire life cycle of a project. Applicator is available: Via the Internet: https://portal.endress.com/webapp/applicator

Accessories	Description
Configurator	<p>Product Configurator - the tool for individual product configuration</p> <ul style="list-style-type: none"> ■ Up-to-the-minute configuration data ■ Depending on the device: Direct input of measuring point-specific information such as measuring range or operating language ■ Automatic verification of exclusion criteria ■ Automatic creation of the order code and its breakdown in PDF or Excel output format ■ Ability to order directly in the Endress+Hauser Online Shop <p>The Configurator is available on the Endress+Hauser website at: www.endress.com -> Click "Corporate" -> Select your country -> Click "Products" -> Select the product using the filters and search field -> Open product page -> The "Configure" button to the right of the product image opens the Product Configurator.</p>
DeviceCare SFE100	<p>Configuration tool for devices via fieldbus protocols and Endress+Hauser service protocols.</p> <p>DeviceCare is the tool developed by Endress+Hauser for the configuration of Endress+Hauser devices. All smart devices in a plant can be configured via a point-to-point or point-to-bus connection. The user-friendly menus enable transparent and intuitive access to the field devices.</p> <p> For details, see Operating Instructions BA00027S</p>
FieldCare SFE500	<p>FDT-based plant asset management tool from Endress+Hauser.</p> <p>It can configure all smart field units in your system and helps you manage them. By using the status information, it is also a simple but effective way of checking their status and condition.</p> <p> For details, see Operating Instructions BA00027S and BA00065S</p>



12.3.1 Service-specific accessories



Device Viewer

The Device Viewer is an online tool for the device-specific selection of device information, technical documentation including device-specific documents. Using the serial number of a device, the Device Viewer displays information about the product life cycle, documents, spare parts, etc.

The Device Viewer is available: <https://portal.endress.com/webapp/DeviceViewer/>

12.4 System components

Accessories	Description
RN22	<p>Single- or two-channel active barrier for safe separation of 0/4 to 20 mA standard signal circuits with bidirectional HART[®] transmission. In the signal duplicator option, the input signal is transmitted to two galvanically isolated outputs. The device has one active and one passive current input; the outputs can be operated actively or passively. The RN22 requires a supply voltage of 24 V_{DC}.</p> <p> For details, see Technical Information TI01515K</p>
RN42	<p>Single-channel active barrier for safe separation of 0/4 to 20 mA standard signal circuits with bidirectional HART[®] transmission. The device has one active and one passive current input; the outputs can be operated actively or passively. The RN42 can be powered with a wide range voltage of 24 to 230 V_{AC/DC}.</p> <p> For details, see Technical Information TI01584K</p>

Accessories	Description
RIA15	Process display, digital, loop-powered display unit for 4 to 20 mA circuits, panel mounting, with optional HART® communication. Displays 4 to 20 mA or up to 4 HART® process variables  For details, see Technical Information TI01043K
RNB22	System power supply unit with wide-range input 100 to 240 V _{AC} / 110 to 250 V _{DC} Primary switch mode power supply unit, single-phase, output 24 V _{DC} / 2.5 A  For details, see Technical Information TI01585K

13 Technical data

13.1 Input

Measured variable Temperature (temperature-linear transmission behavior), resistance and voltage.

Resistance thermometer (RTD) as per standard	Designation	α	Measuring range limits	Min. span
IEC 60751:2022	Pt100 (1) Pt200 (2) Pt500 (3) Pt1000 (4)	0.003851	-200 to +850 °C (-328 to +1562 °F) -200 to +850 °C (-328 to +1562 °F) -200 to +500 °C (-328 to +932 °F) -200 to +250 °C (-328 to +482 °F)	10 K (18 °F)
JIS C1604:1984	Pt100 (5)	0.003916	-200 to +510 °C (-328 to +950 °F)	10 K (18 °F)
DIN 43760 IPTS-68	Ni100 (6) Ni120 (7)	0.006180	-60 to +250 °C (-76 to +482 °F) -60 to +250 °C (-76 to +482 °F)	10 K (18 °F)
GOST 6651-94	Pt50 (8) Pt100 (9)	0.003910	-185 to +1100 °C (-301 to +2012 °F) -200 to +850 °C (-328 to +1562 °F)	10 K (18 °F)
OIML R84: 2003, GOST 6651-2009	Cu50 (10) Cu100 (11)	0.004280	-180 to +200 °C (-292 to +392 °F) -180 to +200 °C (-292 to +392 °F)	10 K (18 °F)
	Ni100 (12) Ni120 (13)	0.006170	-60 to +180 °C (-76 to +356 °F) -60 to +180 °C (-76 to +356 °F)	10 K (18 °F)
OIML R84: 2003, GOST 6651-94	Cu50 (14)	0.004260	-50 to +200 °C (-58 to +392 °F)	10 K (18 °F)
-	Pt100 (Callendar van Dusen) Nickel polynomial Copper polynomial	-	The measuring range limits are specified by entering the limit values that depend on the coefficients A to C and R0.	10 K (18 °F)
<ul style="list-style-type: none"> ■ Connection type: 2-wire, 3-wire or 4-wire connection, sensor current: ≤ 0.3 mA ■ With 2-wire circuit, compensation of wire resistance possible (0 to 30 Ω) ■ With 3-wire and 4-wire connection, sensor wire resistance up to max. 50 Ω per wire 				
Resistance transmitter	Resistance Ω		10 to 400 Ω 10 to 2000 Ω	10 Ω 10 Ω

Thermocouples as per standard	Designation	Measuring range limits		Min. span
IEC 60584, Part 1 ASTM E230-3	Type A (W5Re-W20Re) (30)	0 to +2500 °C (+32 to +4532 °F)	Recommended temperature range: 0 to +2500 °C (+32 to +4532 °F)	50 K (90 °F)
	Type B (PtRh30-PtRh6) (31)	+40 to +1820 °C (+104 to +3308 °F)	+500 to +1820 °C (+932 to +3308 °F)	50 K (90 °F)
	Type E (NiCr-CuNi) (34)	-250 to +1000 °C (-482 to +1832 °F)	-150 to +1000 °C (-238 to +1832 °F)	50 K (90 °F)
	Type J (Fe-CuNi) (35)	-210 to +1200 °C (-346 to +2192 °F)	-150 to +1200 °C (-238 to +2192 °F)	50 K (90 °F)
	Type K (NiCr-Ni) (36)	-270 to +1372 °C (-454 to +2501 °F)	-150 to +1200 °C (-238 to +2192 °F)	50 K (90 °F)
	Type N (NiCrSi-NiSi) (37)	-270 to +1300 °C (-454 to +2372 °F)	-150 to +1300 °C (-238 to +2372 °F)	50 K (90 °F)
	Type R (PtRh13-Pt) (38)	-50 to +1768 °C (-58 to +3214 °F)	+200 to +1768 °C (+392 to +3214 °F)	50 K (90 °F)
	Type S (PtRh10-Pt) (39)	-50 to +1768 °C (-58 to +3214 °F)	+200 to +1768 °C (+392 to +3214 °F)	50 K (90 °F)
Type T (Cu-CuNi) (40)	-200 to +400 °C (-328 to +752 °F)	-150 to +400 °C (-238 to +752 °F)	50 K (90 °F)	
IEC 60584, Part 1 ASTM E230-3 ASTM E988-96	Type C (W5Re-W26Re) (32)	0 to +2315 °C (+32 to +4199 °F)	0 to +2000 °C (+32 to +3632 °F)	50 K (90 °F)
ASTM E988-96	Type D (W3Re-W25Re) (33)	0 to +2315 °C (+32 to +4199 °F)	0 to +2000 °C (+32 to +3632 °F)	50 K (90 °F)
DIN 43710	Type L (Fe-CuNi) (41) Type U (Cu-CuNi) (42)	-200 to +900 °C (-328 to +1652 °F) -200 to +600 °C (-328 to +1112 °F)	-150 to +900 °C (-238 to +1652 °F) -150 to +600 °C (-238 to +1112 °F)	50 K (90 °F)
GOST R8.585-2001	Type L (NiCr-CuNi) (43)	-200 to +800 °C (-328 to +1472 °F)	-200 to +800 °C (+328 to +1472 °F)	50 K (90 °F)

Thermocouples as per standard	Designation	Measuring range limits	Min. span
	<ul style="list-style-type: none"> Internal reference junction (Pt100) External preset value: configurable value -40 to +85 °C (-40 to +185 °F) Maximum sensor wire resistance 10 kΩ 		
Voltage transmitter (mV)	Millivolt transmitter (mV)	-20 to 100 mV	5 mV

13.2 Output

Output signal	Analog output	4 to 20 mA, 20 to 4 mA (can be inverted)
	Signal encoding	FSK ±0.5 mA via current signal
	Data transmission rate	1200 baud
	Galvanic isolation	U = 2 kV AC for 1 minute (input/output)

Failure information

Failure information as per NAMUR NE43:

Failure information is created if the measuring information is missing or not valid. A complete list of all the errors occurring in the measuring system is created.

Underranging	Linear decrease from 4.0 to 3.8 mA
Overranging	Linear increase from 20.0 to 20.5 mA
Failure e.g. sensor failure; sensor short-circuit	≤ 3.6 mA ("low") or ≥ 21 mA ("high"), can be selected

Load

$R_{b \max} = (U_{b \max} - 10 \text{ V}) / 0.023 \text{ A}$ (current output). Valid for head transmitter

Load in Ohm
 U_b = supply voltage in V DC

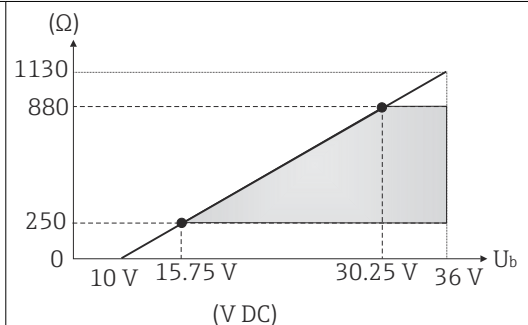

Linearization/transmission behavior

Temperature-linear, resistance-linear, voltage-linear

Filter

1st order digital filter: 0 to 120 s

Protocol-specific data

Manufacturer ID	17 (0x11)
Device type ID	0x11D2
HART® specification	7
Device address in multi-drop mode	Software setting addresses 0 to 63
Device description files (DTM, DD)	Information and files available at: www.endress.com www.fieldcommgroup.org
HART load	Min. 250 Ω

HART device variables	<p>Measured value for primary value (PV) Sensor (measured value)</p> <p>Measured values for SV, TV, QV (secondary, tertiary and quaternary variable)</p> <ul style="list-style-type: none"> ▪ SV: device temperature ▪ TV: sensor (measured value) ▪ QV: sensor (measured value)
Supported functions	Condensed status

Wireless HART data

Minimum starting voltage	10 V _{DC}
Start-up current	3.58 mA
Start-up time	7 s
Minimum operating voltage	10 V _{DC}
Multidrop current	4.0 mA
Time for connection setup	9 s

Write protection for device parameters Software: user role-based concept (password assignment)

Switch-on delay ≤ 7 s until the first valid measured value signal is present at the current output and until the start of HART® communication. While switch-on delay = I_a ≤ 3.8 mA

13.3 Power supply

Supply voltage Values for non-hazardous areas, protected against polarity reversal:
U = 10 to 36 V_{DC}
Values for hazardous area, see Ex documentation.

Current consumption

- 3.6 to 23 mA
- Minimum current consumption 3.5 mA
- Current limit ≤ 23 mA

Terminals	Terminal design	Cable design	Cable cross-section
	Screw terminals	Rigid or flexible	≤ 1.5 mm ² (16 AWG)

13.4 Performance characteristics

Response time	Resistance thermometer (RTD) and resistance transmitter (Ω measurement)	≤ 1 s
	Thermocouples (TC) and voltage transmitters (mV)	≤ 1 s
	Reference temperature	≤ 1 s

 When recording step responses, it must be taken into account that the times of the internal reference measuring point are added to the specified times where applicable.

Refresh time Approx. 100 ms

Reference operating conditions ■ Calibration temperature: +25 °C ±3 K (77 °F ±5.4 °F)
 ■ Supply voltage: 24 V DC
 ■ 4-wire circuit for resistance adjustment

Maximum measured error In accordance with DIN EN 60770 and the reference conditions specified above. The measured error data correspond to $\pm 2 \sigma$ (Gaussian distribution). The data include non-linearities and repeatability.

MV = Measured value

LRV = Lower range value of relevant sensor

Typical

Standard	Designation	Measuring range	Typical measured error (\pm)	
Resistance thermometer (RTD) as per standard			Digital value ¹⁾	Value at current output
IEC 60751:2008	Pt100 (1)	0 to +200 °C (32 to +392 °F)	0.12 °C (0.22 °F)	0.14 °C (0.25 °F)
IEC 60751:2008	Pt1000 (4)		0.09 °C (0.16 °F)	0.11 °C (0.20 °F)
GOST 6651-94	Pt100 (9)		0.10 °C (0.18 °F)	0.12 °C (0.22 °F)
Thermocouples (TC) as per standard			Digital value ¹⁾	Value at current output
IEC 60584, Part 1	Type K (NiCr-Ni) (36)	0 to +800 °C (32 to +1472 °F)	0.65 °C (1.17 °F)	0.69 °C (1.24 °F)
IEC 60584, Part 1	Type S (PtRh10-Pt) (39)		1.50 °C (2.70 °F)	1.52 °C (2.74 °F)
GOST R8.585-2001	Type L (NiCr-CuNi) (43)		2.60 °C (4.68 °F)	2.61 °C (4.70 °F)

1) Measured value transmitted via HART®.

Measured error for resistance thermometers (RTD) and resistance transmitters

Standard	Designation	Measuring range	Measured error (\pm)	
			Digital ¹⁾	D/A ²⁾
			Based on measured value ³⁾	
IEC 60751:2008	Pt100 (1)	-200 to +850 °C (-328 to +1562 °F)	ME = \pm (0.1 °C (0.18 °F) + 0.006% * (MV - LRV))	
	Pt200 (2)		ME = \pm (0.2 °C (0.36 °F) + 0.011% * (MV - LRV))	
	Pt500 (3)	-200 to +510 °C (-328 to +950 °F)	ME = \pm (0.1 °C (0.18 °F) + 0.008% * (MV - LRV))	
	Pt1000 (4)	-200 to +250 °C (-328 to +482 °F)	ME = \pm (0.06 °C (0.11 °F) + 0.007% * (MV - LRV))	
JIS C1604:1984	Pt100 (5)	-200 to +510 °C (-328 to +950 °F)	ME = \pm (0.08 °C (0.14 °F) + 0.006% * (MV - LRV))	
GOST 6651-94	Pt50 (8)	-185 to +1100 °C (-301 to +2012 °F)	ME = \pm (0.13 °C (0.23 °F) + 0.008% * (MV - LRV))	
	Pt100 (9)	-200 to +850 °C (-328 to +1562 °F)	ME = \pm (0.08 °C (0.14 °F) + 0.0055% * (MV - LRV))	
DIN 43760 IPTS-68	Ni100 (6)	-60 to +250 °C (-76 to +482 °F)	ME = \pm (0.08 °C (0.14 °F) - 0.004% * (MV - LRV))	
	Ni120 (7)			
OIML R84: 2003 / GOST 6651-2009	Cu50 (10)	-180 to +200 °C (-292 to +392 °F)	ME = \pm (0.12 °C (0.22 °F) + 0.006% * (MV - LRV))	
	Cu100 (11)	-180 to +200 °C (-292 to +392 °F)	ME = \pm (0.08 °C (0.14 °F) + 0.003% * (MV - LRV))	
	Ni100 (12)	-60 to +180 °C (-76 to +356 °F)	ME = \pm (0.08 °C (0.14 °F) - 0.004% * (MV - LRV))	
	Ni120 (13)			

Standard	Designation	Measuring range	Measured error (±)	
			Digital ¹⁾	D/A ²⁾
OIML R84: 2003, GOST 6651-94	Cu50 (14)	-50 to +200 °C (-58 to +392 °F)	ME = ± (0.12 °C (0.22 °F) + 0.004% * (MV - LRV))	
Resistance transmitter	Resistance Ω	10 to 400 Ω	ME = ± 25 mΩ + 0.0032% * MV	
		10 to 2 850 Ω	ME = ± 120 mΩ + 0.006% * MV	
			0.03% (≅ 4.8 μA)	

- 1) Measured value transmitted via HART®.
- 2) Percentages based on the configured span of the analog output signal.
- 3) Deviations from maximum measured error possible due to rounding.

Measured error for thermocouples (TC) and voltage transmitters

Standard	Designation	Measuring range	Measured error (±)	
			Digital ¹⁾	D/A ²⁾
			Based on measured value ³⁾	
IEC 60584-1 ASTM E230-3	Type A (30)	0 to +2 500 °C (+32 to +4 532 °F)	ME = ± (1.25 °C (2.25 °F) + 0.026% * (MV - LRV))	
	Type B (31)	+500 to +1 820 °C (+932 to +3 308 °F)	ME = ± (2.25 °C (4.05 °F) - 0.09% * (MV - LRV))	
IEC 60584-1 ASTM E230-3 ASTM E988-96	Type C (32)	0 to +2 000 °C (+32 to +3 632 °F)	ME = ± (1.15 °C (2.07 °F) + 0.0055% * (MV - LRV))	
	Type D (33)		ME = ± (1.25 °C (2.25 °F) - 0.016% * (MV - LRV))	
IEC 60584-1 ASTM E230-3	Type E (34)	-150 to +1 000 °C (-238 to +1 832 °F)	ME = ± (0.4 °C (0.72 °F) - 0.008% * (MV - LRV))	
	Type J (35)	-150 to +1 200 °C (-238 to +2 192 °F)	ME = ± (0.45 °C (0.81 °F) - 0.007% * (MV - LRV))	
	Type K (36)		ME = ± (0.6 °C (1.08 °F) - 0.01% * (MV - LRV))	
	Type N (37)	-150 to +1 300 °C (-238 to +2 372 °F)	ME = ± (0.8 °C (1.44 °F) - 0.025% * (MV - LRV))	
	Type R (38)	+200 to +1 768 °C (+392 to +3 214 °F)	ME = ± (1.6 °C (2.88 °F) - 0.025% * (MV - LRV))	
	Type S (39)		ME = ± (1.6 °C (2.88 °F) - 0.025% * (MV - LRV))	
Type T (40)	-150 to +400 °C (-238 to +752 °F)	ME = ± (0.5 °C (0.9 °F) - 0.05% * (MV - LRV))		
DIN 43710	Type L (41)	-150 to +900 °C (-238 to +1 652 °F)	ME = ± (0.5 °C (0.9 °F) - 0.016% * (MV - LRV))	
	Type U (42)	-150 to +600 °C (-238 to +1 112 °F)	ME = ± (0.55 °C (0.99 °F) - 0.04% * (MV - LRV))	
GOST R8.585-2001	Type L (43)	-200 to +800 °C (-328 to +1 472 °F)	ME = ± (2.45 °C (4.41 °F) - 0.015% * (MV - LRV))	
Voltage transmitter (mV)		-20 to +100 mV	ME = ± 10.0 μV	
			4.8 μA	

- 1) Measured value transmitted via HART®.
- 2) Percentages based on the configured span of the analog output signal.
- 3) Deviations from maximum measured error possible due to rounding.

$$\text{Total measured error of transmitter at current output} = \sqrt{(\text{Measured error digital}^2 + \text{Measured error D/A}^2)}$$

Sample calculation with Pt100, measuring range 0 to +200 °C (+32 to +392 °F), ambient temperature +25 °C (+77 °F), supply voltage 24 V:

Measured error digital = $0.1\text{ °C} + 0.006\% \times (200\text{ °C} - (-200\text{ °C}))$:	0.12 °C (0.22 °F)
Measured error D/A = $0.003\% \times 200\text{ °C}$ (360 °F)	0.06 °C (0.11 °F)
Measured error digital value (HART):	0.12 °C (0.22 °F)
Measured error analog value (current output): $\sqrt{(\text{Measured error digital}^2 + \text{Measured error D/A}^2)}$	0.14 °C (0.25 °F)

Sample calculation with Pt100, measuring range 0 to +200 °C (+32 to +392 °F), ambient temperature +35 °C (+95 °F), supply voltage 30 V:

Measured error digital = $0.1\text{ °C} + 0.006\% \times (200\text{ °C} - (-200\text{ °C}))$:	0.12 °C (0.22 °F)
Measured error D/A = $0.03\% \times 200\text{ °C}$ (360 °F)	0.06 °C (0.108 °F)
Influence of ambient temperature (digital) = $(35 - 25) \times (0.0017\% \times 200\text{ °C} - (-200\text{ °C}))$, min. 0.003 °C	0.07 °C (0.13 °F)
Influence of ambient temperature (D/A) = $(35 - 25) \times (0.003\% \times 200\text{ °C})$	0.06 °C (0.108 °F)
Influence of supply voltage (digital) = $(30 - 24) \times (0.01\% \times 200\text{ °C} - (-200\text{ °C}))$, min. 0.005 °C	0.02 °C (0.036 °F)
Influence of supply voltage (D/A) = $(30 - 24) \times (0.003\% \times 200\text{ °C})$	0.04 °C (0.72 °F)
Measured error digital value (HART): $\sqrt{(\text{Measured error digital}^2 + \text{Influence of ambient temperature (digital)}^2 + \text{Influence of supply voltage (digital)}^2)}$	0.14 °C (0.25 °F)
Measured error analog value (current output): $\sqrt{(\text{Measured error digital}^2 + \text{Measured error D/A}^2 + \text{Influence of ambient temperature (digital)}^2 + \text{Influence of ambient temperature (D/A)}^2 + \text{Influence of supply voltage (digital)}^2 + \text{Influence of supply voltage (D/A)}^2)}$	0.17 °C (0.31 °F)

Sensor adjustment

Sensor-transmitter matching

RTD sensors are one of the most linear temperature measuring elements. Nevertheless, the output must be linearized. To significantly improve temperature measurement accuracy, the device allows the use of two methods:

- Callendar van Dusen coefficients (Pt100 resistance thermometer)

The Callendar van Dusen equation is described as:

$$R_T = R_0 [1 + AT + BT^2 + C(T - 100)T^3]$$

The coefficients A, B and C are used to match the sensor (platinum) and transmitter in order to improve the accuracy of the measuring system. The coefficients for a standard sensor are specified in IEC 751. If no standard sensor is available or if greater accuracy is required, the coefficients for each sensor can be determined specifically with the aid of sensor calibration.

- Linearization for copper/nickel resistance thermometers (RTD)

The polynomial equation for copper/nickel is as follows:

$$R_T = R_0 (1 + AT + BT^2)$$

The coefficients A and B are used for the linearization of nickel or copper resistance thermometers (RTD). The exact values of the coefficients derive from the calibration data and are specific to each sensor. The sensor-specific coefficients are then sent to the transmitter.

Sensor-transmitter matching using one of the methods mentioned above significantly improves the temperature measurement accuracy of the entire system. This is because the

transmitter uses the specific data pertaining to the connected sensor to calculate the measured temperature, instead of using the standardized sensor curve data.

1-point adjustment (offset)

Shifts the sensor value

Current output adjustment Correction of the 4 or 20 mA current output value.

Operating influences The measured error data correspond to 2 σ (Gaussian distribution).

Influence of ambient temperature and supply voltage on operation for resistance thermometers (RTD) and resistance transmitters

Designation	Standard	Ambient temperature: Influence (\pm) per 1 °C (1.8 °F) change		Supply voltage: Influence (\pm) per V change	
		Digital ¹⁾	D/A ²⁾	Digital ¹⁾	D/A ²⁾
		Based on measured value		Based on measured value	
Pt100 (1)	IEC 60751:2008	0.0015% * (MV - LRV), at least 0.003 °C (0.005 °F)	0.003 %	0.001% * (MV - LRV), at least 0.002 °C (0.004 °F)	0.003 %
Pt200 (2)		at least 0.014 °C (0.025 °F)		at least 0.008 °C (0.014 °F)	
Pt500 (3)		0.0015% * (MV - LRV), at least 0.006 °C (0.011 °F)		0.0009% * (MV - LRV), at least 0.003 °C (0.005 °F)	
Pt1000 (4)		at least 0.003 °C (0.005 °F)		at least 0.002 °C (0.004 °F)	
Pt100 (5)	JIS C1604:1984	0.0017% * (MV - LRV), at least 0.003 °C (0.005 °F)		0.0009% * (MV - LRV), at least 0.002 °C (0.004 °F)	
Pt50 (8)	GOST 6651-94	0.0017% * (MV - LRV), at least 0.006 °C (0.011 °F)		0.0011% * (MV - LRV), at least 0.003 °C (0.005 °F)	
Pt100 (9)		0.0015% * (MV - LRV), at least 0.003 °C (0.005 °F)		0.0009% * (MV - LRV), at least 0.002 °C (0.004 °F)	
Ni100 (6)	DIN 43760 IPTS-68	at least 0.002 °C (0.004 °F)		0.003 %	
Ni120 (7)					
Cu50 (10)	OIML R84: 2003 / GOST 6651-2009	at least 0.005 °C (0.009 °F)	at least 0.003 °C (0.005 °F)		
Cu100 (11)		at least 0.003 °C (0.005 °F)	at least 0.002 °C (0.004 °F)		
Ni100 (12)		at least 0.002 °C (0.004 °F)	at least 0.001 °C (0.002 °F)		
Ni120 (13)		at least 0.002 °C (0.004 °F)	at least 0.003 °C (0.005 °F)		
Cu50 (14)	OIML R84: 2003 / GOST 6651-94	at least 0.006 °C (0.011 °F)	at least 0.003 °C (0.005 °F)		
Resistance transmitter (Ω)					
10 to 400 Ω		0.0012% * MV, at least 1 m Ω	0.003 %	0.0007% * MV, at least 1 m Ω	0.003 %
10 to 2000 Ω		0.0013% * MV, at least 12 m Ω		0.0008% * MV, at least 7 m Ω	

- 1) Measured value transmitted via HART®.
- 2) Percentages based on the configured span of the analog output signal

Influence of ambient temperature and supply voltage on operation for thermocouples (TC) and voltage transmitters

Designation	Standard	Ambient temperature: Influence (±) per 1 °C (1.8 °F) change		Supply voltage: Influence (±) per V change	
		Digital ¹⁾	D/A ²⁾	Digital	D/A ²⁾
		Based on measured value		Based on measured value	
Type A (30)	IEC 60584-1 ASTM E230-3	0.0032% * (MV - LRV), at least 0.010 °C (0.018 °F)		0.0017% * (MV - LRV), at least 0.010 °C (0.018 °F)	
Type B (31)		at least 0.020 °C (0.036 °F)		at least 0.010 °C (0.018 °F)	
Type C (32)	IEC 60584-1 ASTM E230-3 ASTM E988-96	0.0025% * (MV - LRV), at least 0.010 °C (0.018 °F)		0.0015% * (MV - LRV), at least 0.010 °C (0.018 °F)	
Type D (33)	ASTM E988-96	0.0023% * (MV - LRV), at least 0.010 °C (0.018 °F)		0.0013% * (MV - LRV)	
Type E (34)	IEC 60584-1 ASTM E230-3	0.0016% * (MV - LRV)		0.001% * (MV - LRV)	
Type J (35)		0.0018% * (MV - LRV)			
Type K (36)		0.0018% * (MV - LRV), at least 0.010 °C (0.018 °F)			
Type N (37)		at least 0.020 °C (0.036 °F)		0.003%	
Type R (38)		at least 0.010 °C (0.018 °F)			
Type S (39)		at least 0.010 °C (0.018 °F)			
Type T (40)		at least 0.010 °C (0.018 °F)			
Type L (41)	DIN 43710	≤ 0.01 °C (0.018 °F)		0.003%	
Type U (42)					
Type L (43)	GOST R8.585-2001				
Voltage transmitter (mV)					
-20 to 100 mV	-	0.002% * MV		0.003%	0.0008% * MV

1) Measured value transmitted via HART®.

2) Percentages based on the configured span of the analog output signal

MV = Measured value

LRV = Lower range value of relevant sensor

Total measured error of transmitter at current output = $\sqrt{(\text{Measured error digital}^2 + \text{Measured error D/A}^2)}$

Long-term drift, resistance thermometers (RTD) and resistance transmitters

Designation	Standard	Long-term drift (±) ¹⁾		
		after 1 year	after 3 years	after 5 years
		Based on measured value		
Pt100 (1)	IEC 60751:2008	≤ 0.009% * (MV - LRV) or 0.03 °C (0.05 °F)	≤ 0.0103% * (MV - LRV) or 0.03 °C (0.05 °F)	≤ 0.0122% * (MV - LRV) or 0.04 °C (0.06 °F)
Pt200 (2)		0.10 °C (0.19 °F)	0.13 °C (0.24 °F)	0.15 °C (0.26 °F)
Pt500 (3)		≤ 0.0095% * (MV - LRV) or 0.04 °C (0.06 °F)	≤ 0.0121% * (MV - LRV) or 0.04 °C (0.06 °F)	≤ 0.0136% * (MV - LRV) or 0.04 °C (0.06 °F)
Pt1000 (4)		≤ 0.0096% * (MV - LRV) or 0.02 °C (0.04 °F)	≤ 0.0125% * (MV - LRV) or 0.03 °C (0.05 °F)	≤ 0.0143% * (MV - LRV) or 0.03 °C (0.05 °F)
Pt100 (5)	JIS C1604:1984	≤ 0.0077% * (MV - LRV) or 0.02 °C (0.04 °F)	≤ 0.0102% * (MV - LRV) or 0.03 °C (0.05 °F)	≤ 0.0112% * (MV - LRV) or 0.03 °C (0.05 °F)

Designation	Standard	Long-term drift (\pm) ¹⁾		
Pt50 (8)	GOST 6651-94	$\leq 0.0076\%$ * (MV - LRV) or 0.05 °C (0.09 °F)	$\leq 0.01\%$ * (MV - LRV) or 0.06 °C (0.11 °F)	$\leq 0.011\%$ * (MV - LRV) or 0.07 °C (0.12 °F)
Pt100 (9)		$\leq 0.008\%$ * (MV - LRV) or 0.02 °C (0.04 °F)	$\leq 0.0105\%$ * (MV - LRV) or 0.03 °C (0.05 °F)	$\leq 0.0114\%$ * (MV - LRV) or 0.03 °C (0.05 °F)
Ni100 (6)	DIN 43760 IPTS-68	0.02 °C (0.04 °F)	0.02 °C (0.04 °F)	0.03 °C (0.05 °F)
Ni120 (7)				
Cu50 (10)	OIML R84: 2003 / GOST 6651-2009	0.04 °C (0.06 °F)	0.05 °C (0.09 °F)	0.06 °C (0.11 °F)
Cu100 (11)		0.03 °C (0.05 °F)	0.04 °C (0.06 °F)	0.04 °C (0.06 °F)
Ni100 (12)		0.02 °C (0.04 °F)	0.02 °C (0.04 °F)	0.03 °C (0.05 °F)
Ni120 (13)				
Cu50 (14)	OIML R84: 2003 / GOST 6651-94	0.04 °C (0.06 °F)	0.05 °C (0.09 °F)	0.06 °C (0.11 °F)
Resistance transmitter				
10 to 400 Ω		$\leq 0.0055\%$ * MV or 7 m Ω	$\leq 0.0073\%$ * MV or 10 m Ω	$\leq 0.008\%$ * (MV - LRV) or 11 m Ω
10 to 2000 Ω		$\leq 0.007\%$ * (MV - LRV) or 47 m Ω	$\leq 0.009\%$ * (MV - LRV) or 60 m Ω	$\leq 0.0067\%$ * (MV - LRV) or 67 m Ω

1) Whichever is greater

Long-term drift, thermocouples (TC) and voltage transmitters

Designation	Standard	Long-term drift (\pm) ¹⁾		
		after 1 year	after 3 years	after 5 years
Based on measured value				
Type A (30)	IEC 60584-1 ASTM E230-3	$\leq 0.049\%$ * (MV - LRV) or 0.75 °C (1.35 °F)	$\leq 0.063\%$ * (MV - LRV) or 0.98 °C (1.76 °F)	$\leq 0.068\%$ * (MV - LRV) or 1.06 °C (1.91 °F)
Type B (31)		1.75 °C (3.15 °F)	2.30 °C (4.14 °F)	2.50 °C (4.50 °F)
Type C (32)	IEC 60584-1 ASTM E230-3 ASTM E988-96	0.80 °C (1.44 °F)	1.02 °C (1.84 °F)	1.10 °C (1.98 °F)
Type D (33)	ASTM E988-96	0.97 °C (1.75 °F)	1.25 °C (2.25 °F)	1.36 °C (2.45 °F)
Type E (34)	IEC 60584-1 ASTM E230-3	0.28 °C (0.50 °F)	0.36 °C (0.65 °F)	0.39 °C (0.70 °F)
Type J (35)		0.34 °C (0.61 °F)	0.44 °C (0.79 °F)	0.48 °C (0.86 °F)
Type K (36)		0.40 °C (0.72 °F)	0.51 °C (0.92 °F)	0.56 °C (1.01 °F)
Type N (37)		0.57 °C (1.03 °F)	0.676 °C (1.37 °F)	0.82 °C (1.48 °F)
Type R (38)		1.28 °C (2.30 °F)	1.69 °C (3.04 °F)	1.85 °C (3.33 °F)
Type S (39)		1.29 °C (2.32 °F)	1.70 °C (3.06 °F)	
Type T (40)		0.42 °C (0.76 °F)	0.55 °C (0.99 °F)	0.60 °C (1.08 °F)
Type L (41)	DIN 43710	0.28 °C (0.50 °F)	0.36 °C (0.65 °F)	0.40 °C (0.72 °F)
Type U (42)		0.41 °C (0.74 °F)	0.54 °C (0.97 °F)	0.58 °C (1.04 °F)
Type L (43)	GOST R8.585-2001	0.34 °C (0.61 °F)	0.45 °C (0.81 °F)	0.48 °C (0.86 °F)
Voltage transmitter (mV)				
-20 to 100 mV		$\leq 0.027\%$ * MV or 9 μ V	$\leq 0.035\%$ * MV or 12 μ V	$\leq 0.038\%$ * MV or 13 μ V

1) Whichever is greater

Analog output long-term drift

Long-term drift D/A ¹⁾ (±)		
after 1 year	after 3 years	after 5 years
0.030%	0.036%	0.038%

1) Percentages based on the configured span of the analog output signal.

Influence of the reference junction Pt100 DIN IEC 60751 Cl. B (internal reference junction with thermocouples TC)

13.5 Environment

Ambient temperature -40 to +85 °C (-40 to +185 °F), for hazardous areas see Ex documentation.

Storage temperature -50 to +100 °C (-58 to +212 °F)

Operating altitude Up to 4 000 m (4 374.5 yard) above sea level.

Humidity Condensation:
 ■ Permitted
 ■ Max. rel. humidity: 95 % as per IEC 60068-2-30

Climate class Climate class C1 as per IEC 60654-1

Degree of protection With screw terminals: IP 20. In the installed state, it depends on the terminal head or field housing used.

Shock and vibration resistance Vibration resistance according to DNVGL-CG-0339 : 2015 and DIN EN 60068-2-27
 2 to 100 Hz at 4g (increased vibration stress)
 Shock resistance as per KTA 3505 (section 5.8.4 Shock test)

Electromagnetic compatibility (EMC) **CE conformity**
 Electromagnetic compatibility in accordance with all the relevant requirements of the IEC/EN 61326 series and NAMUR Recommendation EMC (NE21). For details, refer to the Declaration of Conformity. All tests were passed both with and without ongoing digital HART® communication. To ensure interference-free HART® communication with EMC influence, a shielded cable must be used, with the shield connected to ground on both sides.
 Maximum measured error <1% of measuring range.
 Interference immunity as per IEC/EN 61326 series, industrial requirements
 Interference emission as per IEC/EN 61326 series, Class B equipment

Insulation class Class III

Overvoltage category Overvoltage category II

Pollution degree Pollution degree 2

13.6 Mechanical construction

Design, dimensions Dimensions in mm (in)

Head transmitter

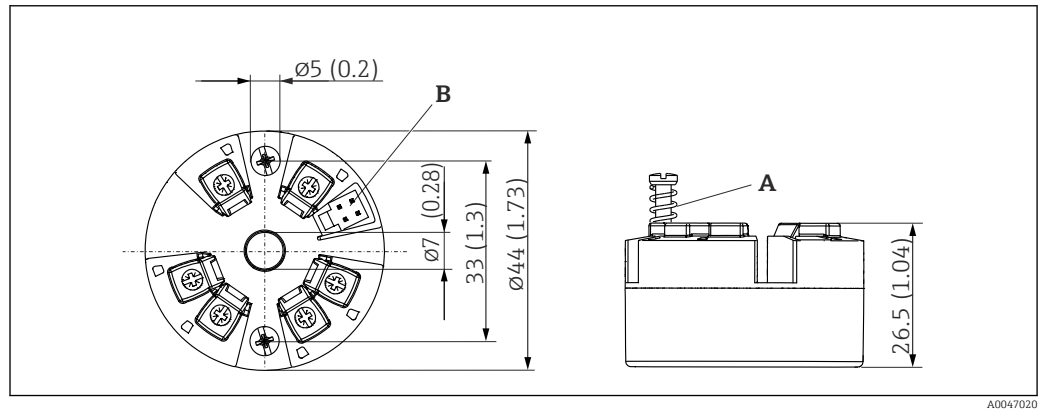

10 Version with screw terminals

- A Spring travel $L \geq 5$ mm (not for US - M4 securing screws)
- B CDI interface for connecting a configuration tool

Weight 40 to 50 g (1.4 to 1.8 oz)

Materials All the materials used are RoHS-compliant.

- Housing: polycarbonate (PC)
- Terminals: screw terminals, nickel-plated brass and gold-plated or tin-plated contacts
- Potting: QSIL 553

13.7 Certificates and approvals

Current certificates and approvals that are available for the product can be selected via the Product Configurator at www.endress.com:

1. Select the product using the filters and search field.
2. Open the product page.
3. Select **Configuration**.

HART® certification The temperature transmitter is registered by the FieldComm Group™. The device meets the requirements of the HART® Communication Protocol Specifications, Revision 7.

MTTF 168 years

The mean time to failure (MTTF) denotes the theoretically expected time until the device fails during normal operation. The term MTTF is used for systems that cannot be repaired, e.g. temperature transmitters.



71590122

www.addresses.endress.com
