

# Operating Instructions

## **Gammapilot FMG50**

Radiometric measuring technology





A0023555

## **Contents of these Operating Instructions**

These Operating Instructions describe how to install and commission the radiometric compact transmitter Gammapilot FMG50. All of the functions that are necessary for standard measuring tasks are included. In addition, the Gammapilot FMG50 provides many additional functions for optimizing the measuring point and for converting the measured value. These functions are not described in these Operating Instructions.



## Table of contents

<b>1</b>	<b>About this document</b> . . . . .	<b>8</b>		
1.1	Purpose of this document . . . . .	8		
1.2	Symbols used . . . . .	8		
1.2.1	Safety symbols . . . . .	8		
1.2.2	Symbols for certain types of information and graphics	8		
1.3	Documentation . . . . .	9		
1.3.1	Technical Information (TI) . . . . .	9		
1.3.2	Brief Operating Instructions (KA) . . . . .	9		
1.3.3	Safety Instructions (XA) . . . . .	9		
1.3.4	Functional Safety Manual (FY) . . . . .	10		
1.4	Terms and abbreviations . . . . .	10		
1.5	Registered trademarks . . . . .	10		
<b>2</b>	<b>Basic safety instructions</b> . . . . .	<b>11</b>		
2.1	Requirements for personnel . . . . .	11		
2.2	Intended use . . . . .	11		
2.3	Installation, commissioning and operation . . . . .	11		
2.4	Hazardous area . . . . .	12		
2.5	Radiation protection . . . . .	12		
2.5.1	Basic radiation protection guidelines . . . . .	12		
2.6	Workplace safety . . . . .	13		
2.7	Operational safety . . . . .	13		
2.8	Product safety . . . . .	13		
2.8.1	CE mark . . . . .	14		
2.8.2	EAC conformity . . . . .	14		
<b>3</b>	<b>Product description</b> . . . . .	<b>15</b>		
3.1	Product design . . . . .	15		
3.1.1	Components of the FMG50 . . . . .	15		
3.2	Nameplates . . . . .	16		
3.2.1	Device nameplate . . . . .	16		
3.3	Scope of delivery . . . . .	16		
3.4	Accompanying documentation . . . . .	16		
3.4.1	Brief Operating Instructions . . . . .	16		
3.4.2	Description of Device Functions . . . . .	17		
3.4.3	Safety instructions . . . . .	17		
<b>4</b>	<b>Mounting</b> . . . . .	<b>18</b>		
4.1	Incoming acceptance, product identification, transport, storage . . . . .	18		
4.1.1	Incoming acceptance . . . . .	18		
4.1.2	Product identification . . . . .	18		
4.1.3	Manufacturer address . . . . .	18		
4.1.4	Transporting to the measuring point . . . . .	18		
4.1.5	Storage . . . . .	18		
4.2	Installation conditions . . . . .	19		
4.2.1	General information . . . . .	19		
4.2.2	Dimensions, weights . . . . .	20		
4.2.3	Installation conditions for level measurement . . . . .	22		
4.2.4	Installation conditions for point level detection . . . . .	23		
4.2.5	Installation conditions for density measurement . . . . .	24		
4.2.6	Installation conditions for interface measurement . . . . .	25		
4.2.7	Installation conditions for density profile measurement (DPS) . . . . .	25		
4.2.8	Installation conditions for concentration measurement . . . . .	26		
4.2.9	Installation conditions for concentration measurement with radiating media . . . . .	27		
4.2.10	Installation conditions for flow measurement . . . . .	27		
4.3	Post-installation check . . . . .	28		
<b>5</b>	<b>Electrical connection</b> . . . . .	<b>29</b>		
5.1	Connection compartment . . . . .	29		
5.2	4 to 20 mA HART connection . . . . .	29		
5.3	Terminal assignment . . . . .	30		
5.4	Cable entries . . . . .	30		
5.5	Potential equalization . . . . .	30		
5.6	Overvoltage protection (optional) . . . . .	31		
5.7	Rated cross-section . . . . .	31		
5.8	Fieldbus connectors . . . . .	31		
5.8.1	Pin assignment for connector M12- A . . . . .	31		
5.8.2	Connection of devices with Harting plug Han7D . . . . .	32		
5.9	FMG50 with RIA15 . . . . .	33		
5.9.1	Connection of the HART device and RIA15 without backlighting . . . . .	33		
5.9.2	Connection of the HART device and RIA15 with backlighting . . . . .	34		
5.9.3	FMG50, RIA15 with installed HART communication resistor module . . . . .	34		
5.10	Wiring . . . . .	35		
5.11	Wiring examples . . . . .	36		
5.11.1	Point level measurement . . . . .	36		
5.11.2	Cascade mode with 2 FMG50 units . . . . .	36		
5.11.3	Cascade mode with more than 2 FMG50 units . . . . .	38		
5.11.4	Ex applications in conjunction with RMA42 . . . . .	39		
5.11.5	SIL applications for Gammapilot in connection with RMA42 . . . . .	40		
5.12	Post-connection check . . . . .	40		
<b>6</b>	<b>Operation</b> . . . . .	<b>41</b>		
6.1	Overview of the HART operating options . . . . .	41		
6.1.1	Via HART protocol . . . . .	41		
6.1.2	Operation via FieldCare/DeviceCare . . . . .	41		
6.1.3	Operation via RIA 15 (remote display) . . . . .	41		
6.1.4	Operation via WirelessHART . . . . .	41		

6.2	Alternative operation options . . . . .	42	8.5.2	Reaction to detected gammagraphy radiation . . . . .	87
6.2.1	Local operation . . . . .	42	8.5.3	Gammagraphy detection limits and behavior in event of excess radiation . . . . .	88
6.2.2	Operation via the service interface . . . . .	42	8.5.4	Gammagraphy settings . . . . .	88
6.2.3	Operation via RIA15 . . . . .	43	8.5.5	Gammagraphy detection parameter . . . . .	88
6.2.4	Operation via Bluetooth® wireless technology . . . . .	43	8.5.6	Gammagraphy hold time parameter . . . . .	89
6.2.5	Heartbeat Verification/Monitoring . . . . .	44	8.5.7	Gammagraphy limit parameter . . . . .	89
6.3	Locking/unlocking configuration . . . . .	45	8.5.8	Gammagraphy sensitivity parameter . . . . .	89
6.3.1	Software locking . . . . .	45	8.6	Density recalibration for multi-point calibration . . . . .	90
6.3.2	Hardware locking . . . . .	45	8.6.1	General principles . . . . .	90
6.4	Resetting to the default configuration . . . . .	45	8.6.2	Performing density recalibration for multi-point calibration . . . . .	90
<b>7</b>	<b>Commissioning . . . . .</b>	<b>47</b>	8.7	Real-time clock and decay compensation . . . . .	90
7.1	Post-installation and post-connection check . . . . .	47	8.7.1	General principles . . . . .	90
7.2	Commissioning using the Commissioning Wizard . . . . .	47	8.7.2	Setting the real-time clock . . . . .	91
7.2.1	General information . . . . .	47	8.8	Behavior in the event of low terminal voltage . . . . .	91
7.2.2	Device identification . . . . .	48	8.8.1	General principles . . . . .	91
7.2.3	Measurement settings . . . . .	48	8.9	History . . . . .	92
7.2.4	Calibration . . . . .	51	8.9.1	Firmware history . . . . .	92
7.2.5	Slave mode . . . . .	74	8.9.2	Hardware history . . . . .	92
7.3	Commissioning via SmartBlue app . . . . .	75	<b>9</b>	<b>Maintenance and repair . . . . .</b>	<b>93</b>
7.3.1	Requirements . . . . .	75	9.1	Cleaning . . . . .	93
7.3.2	SmartBlue app . . . . .	75	9.2	Repair . . . . .	93
7.4	Commissioning via on-site operation . . . . .	75	9.2.1	Repair concept . . . . .	93
7.4.1	Level basic calibration . . . . .	76	9.2.2	Repairs to devices with an Ex-certificate . . . . .	93
7.4.2	Status and power LED . . . . .	76	9.3	Replacement . . . . .	93
7.5	Commissioning of density compensation with RSG45 (gamma computer) . . . . .	77	9.3.1	Level measurement and point level detection . . . . .	93
7.5.1	Scenario 1: density compensation via temperature and pressure measurement . . . . .	77	9.3.2	Density and concentration measurement . . . . .	93
7.5.2	Scenario 2: density compensation via FMG50 gas density measurement . . . . .	79	9.3.3	HistoROM . . . . .	94
7.6	Operation and settings via RIA15 . . . . .	82	9.4	Spare parts . . . . .	94
7.7	Data access - Security . . . . .	82	9.5	Return . . . . .	94
7.7.1	Locking via password in FieldCare / DeviceCare / SmartBlue . . . . .	82	9.6	Disposal . . . . .	94
7.7.2	Hardware locking . . . . .	82	9.6.1	Battery disposal . . . . .	94
7.7.3	Bluetooth® wireless technology (optional) . . . . .	82	9.7	Contact addresses at Endress+Hauser . . . . .	95
7.7.4	RIA15 locking . . . . .	82	<b>10</b>	<b>Accessories . . . . .</b>	<b>96</b>
7.8	Overview of the operating menu . . . . .	82	10.1	Commubox FXA195 HART . . . . .	96
<b>8</b>	<b>Diagnostics and troubleshooting . . . . .</b>	<b>83</b>	10.2	Field Xpert SFX350, SFX370, SMT70 . . . . .	96
8.1	System error messages . . . . .	83	10.3	Mounting device (for level and point level measurement) . . . . .	97
8.1.1	Error signal . . . . .	83	10.3.1	Mounting the retaining bracket . . . . .	97
8.1.2	Types of error . . . . .	83	10.3.2	Mounting instructions . . . . .	97
8.2	Possible calibration errors . . . . .	83	10.3.3	Use . . . . .	100
8.3	Diagnostic event . . . . .	84	10.4	Clamping device for density measurement FHG51 . . . . .	100
8.3.1	Diagnostic event in the operating tool . . . . .	84	10.4.1	FHG51-A#1 . . . . .	100
8.3.2	List of diagnostic events in the operating tool . . . . .	84	10.4.2	FHG51-A#1PA . . . . .	101
8.3.3	Displaying the diagnostic events . . . . .	86	10.4.3	FHG51-B#1 . . . . .	101
8.4	Diagnostic event in RIA15 . . . . .	87	10.4.4	FHG51-B#1PB . . . . .	101
8.5	Gammagraphy . . . . .	87	10.4.5	FHG51-E#1 . . . . .	101
8.5.1	General principles . . . . .	87	10.4.6	FHG51-F#1 . . . . .	101

10.5	Collimator (sensor side) for Gammapilot FMG50	101
10.5.1	Intended use	101
10.5.2	Additional information	101
10.6	Process indicator RIA15	102
10.6.1	HART communication resistor	102
10.7	Memograph M RSG45	102
10.7.1	Level measurement: FMG50 with Memograph M RSG45	102
10.7.2	Additional information	103
10.8	Weather protection cover for dual compartment housing, aluminum	103
10.9	Heat shield for Gammapilot FMG50	105
<b>11</b>	<b>Technical data</b>	<b>106</b>
11.1	Additional technical data	106
11.2	Supplementary documentation	106
11.2.1	Modulator FHG65	106
11.2.2	Source container FQG60	106
11.2.3	Source container FQG61, FQG62	106
11.2.4	Source container FQG63	106
11.2.5	Source container FQG66	106
11.2.6	Clamping device FHG51	106
11.2.7	Mounting device for Gammapilot FMG50	106
11.2.8	Heat shield for Gammapilot FMG50	106
11.2.9	Weather protection cover for dual-compartment housing	107
11.2.10	VU101 Bluetooth® display	107
11.2.11	Process indicator RIA15	107
11.2.12	Memograph M, RSG45	107
11.2.13	Collimator (sensor side) for Gammapilot FMG50	107
<b>12</b>	<b>Certificates and approvals</b>	<b>108</b>
12.1	Functional safety	108
12.2	Heartbeat Monitoring + Verification	108
12.3	Ex approval	108
12.3.1	Explosion-protected smartphones and tablets	108
12.4	Other standards and guidelines	108
12.5	Certificates	108
12.6	CE mark	109
12.7	EAC	109
12.8	Overfill prevention	109

# 1 About this document

## 1.1 Purpose of this document

These Operating Instructions contain all the information that is required in the various phases of the life cycle of the device: from product identification, incoming acceptance and storage, to mounting, connection, operation and commissioning through to troubleshooting, maintenance and disposal.

## 1.2 Symbols used

### 1.2.1 Safety symbols

#### CAUTION

This symbol alerts you to a dangerous situation. Failure to avoid this situation can result in minor or medium injury.

#### DANGER

This symbol alerts you to a dangerous situation. Failure to avoid this situation will result in serious or fatal injury.

#### NOTICE

This symbol contains information on procedures and other facts which do not result in personal injury.

#### WARNING

This symbol alerts you to a dangerous situation. Failure to avoid this situation can result in serious or fatal injury.

### 1.2.2 Symbols for certain types of information and graphics



Warns against radioactive substances or ionizing radiation



#### Permitted

Procedures, processes or actions that are permitted



#### Preferred

Procedures, processes or actions that are preferred



#### Forbidden

Procedures, processes or actions that are forbidden



#### Tip

Indicates additional information



Reference to documentation



Reference to page



Reference to graphic



Notice or individual step to be observed



**1, 2, 3**

Series of steps



Result of a step



Operation via local display



Operation via operating tool



Write-protected parameter

**1, 2, 3, ...**

Item numbers

**A, B, C, ...**

Views



### **Safety instructions**

Observe the safety instructions contained in the associated Operating Instructions

## **1.3 Documentation**

The following types of documentation are available in the Download Area of the Endress+Hauser website ([www.endress.com/downloads](http://www.endress.com/downloads)):



For an overview of the scope of the associated Technical Documentation, refer to the following:

- *Device Viewer* ([www.endress.com/deviceviewer](http://www.endress.com/deviceviewer)): Enter serial number from nameplate.
- *Endress+Hauser Operations app*: Enter serial number from nameplate or scan matrix code on nameplate.

### **1.3.1 Technical Information (TI)**

#### **Planning aid**

The document contains all the technical data on the device and provides an overview of the accessories and other products that can be ordered for the device.

### **1.3.2 Brief Operating Instructions (KA)**

#### **Guide that takes you quickly to the 1st measured value**

The Brief Operating Instructions contain all the essential information from incoming acceptance to initial commissioning.

### **1.3.3 Safety Instructions (XA)**

Depending on the approval, the following Safety Instructions (XA) are supplied with the device. They are an integral part of the Operating Instructions.



The nameplate indicates the Safety Instructions (XA) that are relevant to the device.

### 1.3.4 Functional Safety Manual (FY)

Depending on the SIL approval, the Functional Safety Manual (FY) is an integral part of the Operating Instructions and applies in addition to the Operating Instructions, Technical Information and ATEX Safety Instructions.

 The different requirements that apply for the protective function are described in the Functional Safety Manual (FY).

## 1.4 Terms and abbreviations

### FieldCare

Scalable software tool for device configuration and integrated plant asset management solutions

### DeviceCare

Universal configuration software for Endress+Hauser HART, PROFIBUS, FOUNDATION Fieldbus and Ethernet field devices

### DTM

Device Type Manager

### Operating tool

The term "operating tool" is used in place of the following operating software:

- FieldCare / DeviceCare, for operation via HART communication and PC
- SmartBlue App, for operation using an Android or iOS smartphone or tablet

### CDI

Common Data Interface

### PLC

Programmable logic controller (PLC)

## 1.5 Registered trademarks

### HART®

Registered trademark of the FieldComm Group, Austin, Texas, USA

### Apple®

Apple, the Apple logo, iPhone, and iPod touch are trademarks of Apple Inc., registered in the U.S. and other countries. App Store is a service mark of Apple Inc.

### Android®

Android, Google Play and the Google Play logo are trademarks of Google Inc.

### Bluetooth®

The *Bluetooth*® word mark and logos are registered trademarks owned by the Bluetooth SIG, Inc. and any use of such marks by Endress+Hauser is under license. Other trademarks and trade names are those of their respective owners.

## 2 Basic safety instructions

### 2.1 Requirements for personnel

The personnel for installation, commissioning, diagnostics and maintenance must fulfill the following requirements:

- Trained, qualified specialists must have a relevant qualification for this specific function and task
- Are authorized by the plant owner/operator
- Are familiar with federal/national regulations
- Before beginning work, the specialist staff must have read and understood the instructions in the Operating Instructions and supplementary documentation as well as in the certificates (depending on the application)
- Following instructions and basic conditions

The operating personnel must fulfill the following requirements:

- Being instructed and authorized according to the requirements of the task by the facility's owner-operator
- Following the instructions in these Operating Instructions

### 2.2 Intended use

The Gammapilot FMG50 is a compact transmitter for non-contact level, point level, density and concentration measurement. The detector is up to 3 m (9.84 ft) in length. The Gammapilot FMG50 is certified according to IEC 61508 for safety-related operation up to SIL 2/3.

### 2.3 Installation, commissioning and operation

The Gammapilot FMG50 is designed to meet state-of-the-art safety requirements and complies with applicable standards and EC regulations. However, if it is used improperly or for applications for which it is not intended, application-related hazards may arise, e.g. product overflow due to incorrect installation or configuration. Installation, electrical connection, commissioning, operation and maintenance of the measuring system must therefore be carried out exclusively by trained specialists authorized to perform such work by the system operator. Technical personnel must have read and understood these Operating Instructions and must adhere to them. Modifications and repairs to the device may only be carried out if they are expressly permitted in the Operating Instructions.

#### **⚠ WARNING**

- ▶ The four screws connecting the detector pipe to the terminal head may not be opened.

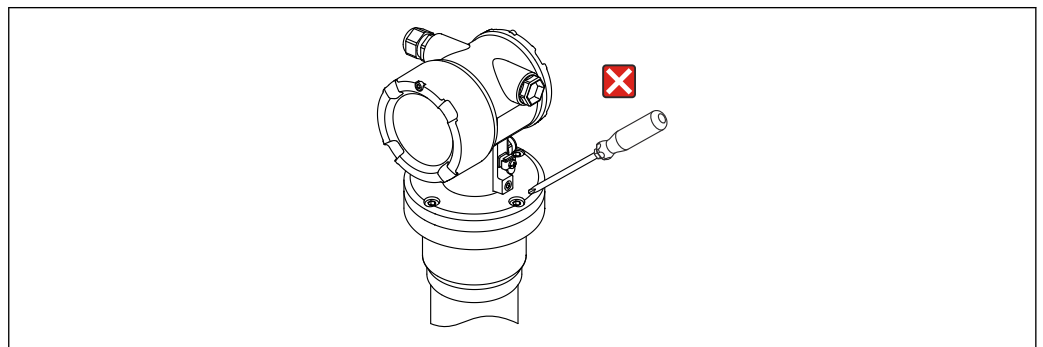

A0038007

## 2.4 Hazardous area

If the measuring system is used in hazardous areas, the corresponding national standards and regulations must be observed. The device is accompanied by separate "Ex documentation", which is an integral part of these Operating Instructions. The installation specifications, connection values and safety instructions listed in this documentation must be observed.

- Technical personnel must be qualified and trained for the hazardous area.
- Comply with the metrological and safety-related requirements for the measuring point.

### **⚠ WARNING**

- ▶ Observe the safety instructions associated with the device. These instructions depend on the certificate ordered.

## 2.5 Radiation protection

The Gammapilot FMG50 is used in conjunction with a radiation source, which is installed in a source container. The Gammapilot FMG50 does not emit any radioactive radiation. When handling radiation sources, the following instructions must be observed:

### 2.5.1 Basic radiation protection guidelines

#### **⚠ WARNING**

- ▶ When working with radiation sources, avoid any unnecessary exposure to radiation. All unavoidable radiation exposure must be kept to a minimum. Three basic concepts apply to achieve this:

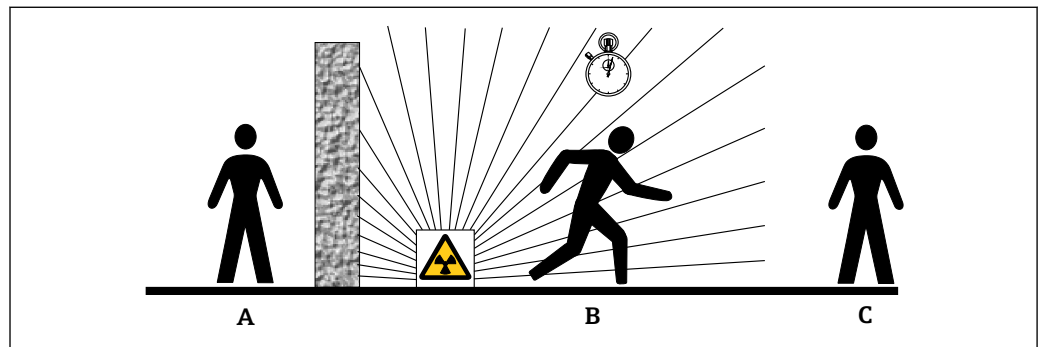

- A *Shielding*  
 B *Time*  
 C *Distance*

#### **⚠ CAUTION**

- ▶ When working with source containers, all the instructions for mounting and usage outlined in the following documents must be observed:



#### Source container documentation

- **FQG60:**  
TI00445F
- **FQG61, FQG62:**  
TI00435F
- **FQG63:**  
TI00446F
- **FQG66:**
  - TI01171F
  - BA01327F

**Shielding**

Ensure the best possible shielding between the radiation source and yourself and all other persons. Effective shielding is provided by source containers (FQG60, FQG61/FQG62, FQG63, FQG66) and all high-density materials (lead, iron, concrete etc.).

**Time**

Remain as short as possible in the area exposed to radiation.

**Distance**

Keep as far away from the radiation source as possible. The radiation intensity decreases in proportion to the square of the distance from the radiation source.

## 2.6 Workplace safety

For work on and with the device:

- ▶ Wear the required personal protective equipment according to federal/national regulations.
- ▶ Switch off the supply voltage before connecting the device.

## 2.7 Operational safety

Risk of injury!

- ▶ Operate the device only if it is in proper technical condition, free from errors and faults.
- ▶ The operator is responsible for interference-free operation of the device.

**Modifications to the device**

Unauthorized modifications to the device are not permitted and can lead to unforeseeable dangers:

- ▶ If modifications are nevertheless required, consult with the manufacturer.

**Repair**

To ensure continued operational safety and reliability:

- ▶ Carry out repairs on the device only if they are expressly permitted.
- ▶ Observe federal/national regulations pertaining to the repair of an electrical device.
- ▶ Use only original spare parts and accessories from the manufacturer.

**Hazardous area**

To eliminate danger to persons or the facility when the device is used in the hazardous area (e.g. explosion protection):

- ▶ Check the nameplate to verify if the device ordered can be put to its intended use in the hazardous area.
- ▶ Observe the specifications in the separate supplementary documentation that is an integral part of these instructions.

## 2.8 Product safety

This measuring device is designed in accordance with good engineering practice to meet state-of-the-art safety requirements, has been tested, and left the factory in a condition in which it is safe to operate. It meets general safety standards and legal requirements.

### **2.8.1 CE mark**

The measuring system meets the legal requirements of the applicable EU Directives. These are listed in the corresponding EU Declaration of Conformity along with the standards applied.

The manufacturer confirms successful testing of the device by affixing to it the CE mark.

### **2.8.2 EAC conformity**

The measuring system meets the legal requirements of the applicable EAC guidelines. These are listed in the corresponding EAC Declaration of Conformity together with the standards applied.

The manufacturer confirms successful testing of the device by affixing to it the EAC mark.

## 3 Product description

### 3.1 Product design

#### 3.1.1 Components of the FMG50

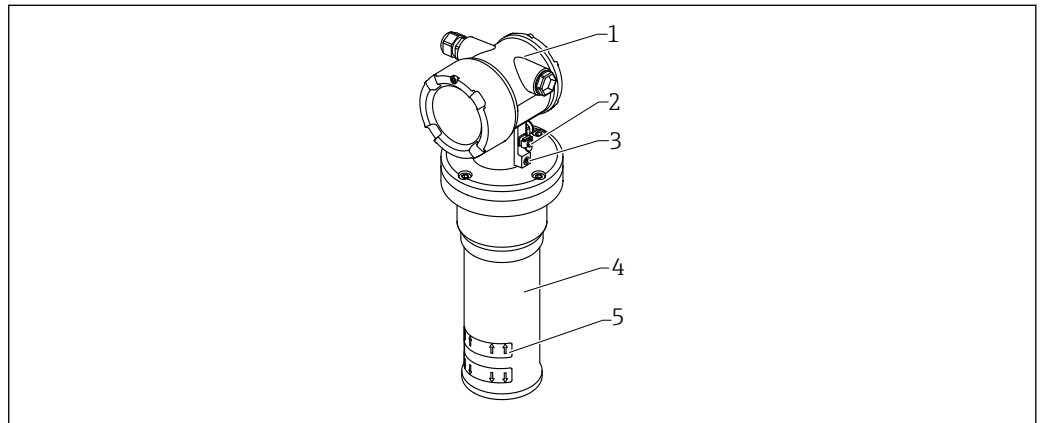

A0037983

1 A: Gammapilot FMG50

- 1 Housing
- 2 Potential equalization terminal
- 3 Locking screw
- 4 Detector pipe
- 5 Measuring range marking

## 3.2 Nameplates

### 3.2.1 Device nameplate

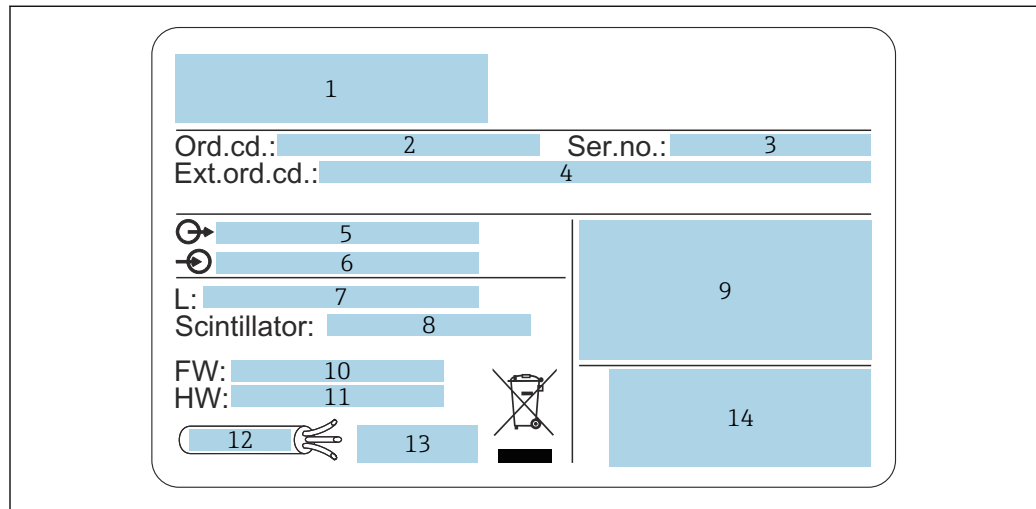

A0039777

- 1 Manufacturer's address and device name
- 2 Order code
- 3 Serial number (ser. no.)
- 4 Extended order code (ext. ord. cd.)
- 5 Signal outputs
- 6 Supply voltage
- 7 Length of measuring range
- 8 Scintillator type
- 9 Certificate and approval-related data
- 10 Firmware version (FW)
- 11 Device revision (Dev.Rev.)
- 12 Temperature specifications for connecting cable
- 13 Permitted ambient temperature ( $T_a$ ), reference to documentation
- 14 Date of manufacture: year-month and 2-D matrix code (QR code)

## 3.3 Scope of delivery

- Ordered version of the device (including Brief Operating Instructions)
- Endress+Hauser operating program on DVD (optional)
- Accessories as ordered

## 3.4 Accompanying documentation

### 3.4.1 Brief Operating Instructions

The Brief Operating Instructions describe how to install and commission the Gammapiot FMG50.



KA01427F

Any additional functions are contained in the Operating Instructions and the "Description of Device Functions" document



### 3.4.2 Description of Device Functions

The Description of Device Functions document contains a detailed description of all the functions of the Gammapilot FMG50 and applies for all communication versions. Available for download at "[www.de.endress.com](http://www.de.endress.com)".



GPO1141F

### 3.4.3 Safety instructions

Additional safety instructions (XA, ZE, ZD) are supplied with certified device versions. Please refer to the nameplate for the safety instructions that apply to your device version.

An overview of the certificates and approvals can be found in the "Certificates and approvals" section.

## 4 Mounting

### 4.1 Incoming acceptance, product identification, transport, storage

#### 4.1.1 Incoming acceptance

Check the following during incoming acceptance:

- Are the order codes on the delivery note and the product sticker identical?
- Are the goods undamaged?
- Do the nameplate data match the ordering information on the delivery note?
- If required (see nameplate): Are the safety instructions (XA) provided?

 If one of these conditions is not met, please contact the manufacturer's sales office.

#### 4.1.2 Product identification

The following options are available for identification of the device:

- Nameplate specifications
- Extended order code with breakdown of the device features on the delivery note
- ▶ Enter serial number from nameplates in *W@M Device Viewer* ([www.endress.com/deviceviewer](http://www.endress.com/deviceviewer))
  - ↳ All of the information on the measuring device and on the scope of the technical documentation pertaining to the device is displayed.
- ▶ Enter the serial number from the nameplate into the *Endress+Hauser Operations App* or scan the 2-D matrix code on the nameplate.
  - ↳ All of the information on the measuring device and on the scope of the technical documentation pertaining to the device is displayed.

#### 4.1.3 Manufacturer address

Endress+Hauser SE+Co. KG  
Hauptstraße 1  
79689 Maulburg, Germany  
Place of manufacture: See nameplate.

#### 4.1.4 Transporting to the measuring point

##### CAUTION

##### Risk of injury

- ▶ Follow the safety instructions and transport conditions for devices weighing more than 18 kg (39.69 lb).

#### 4.1.5 Storage

Pack the device so that it is protected against impact for storage and transport. The original packaging offers the best protection for this. The permitted storage temperature is:

##### NaI (TI) crystal

-40 to +80 °C (-40 to +176 °F)

**PVT scintillator (standard)**

-40 to +60 °C (-40 to +140 °F)

**PVT scintillator (high-temperature version)**

-20 to +80 °C (-4 to +176 °F)

 As the device contains a battery, it is recommended to store the device at room temperature in a location that does not receive direct sunlight

## 4.2 Installation conditions

### 4.2.1 General information

- The angle of emission of the source container must be exactly aligned to the measuring range of the Gammapilot FMG50. Observe the measuring range marks of the device.
- The source container and the Gammapilot FMG50 should be mounted as close to the vessel as possible. Any access to the beam must be blocked to ensure that it is not possible to reach into this area.
- The Gammapilot FMG50 should be protected against direct sunlight or process heat in order to increase its service life.
  - Feature 620, option PA: "Weather protection cover 316L"
  - Feature 620, option PV: "Heat shield 1200-3000 mm, PVT"
  - Feature 620, option PW: "Heat shield NaI, 200-800 mm, PVT"
- Collimators can optionally be ordered with the device for some sensor versions of the device.
  - Feature 620, option P7: "Collimator on sensor side"
- Clamps can optionally be ordered with the device.
  - Feature 620, option Q1: "Mounting clamp 1x d=80 mm, 1x d=95 mm"
  - Feature 620, option Q2: "Mounting clamp 2x d=80 mm, 1x d=95 mm"
  - Feature 620, option Q3: "Mounting clamp 3x d=80 mm, 1x d=95 mm"
  - Feature 620, option Q4: "Retaining bracket"
- The mounting device must be installed in such a way as to withstand the weight of the Gammapilot FMG50 and the mounted parts under all anticipated operating conditions (e.g. vibrations).

 More information with regard to the safety-related use of the Gammapilot FMG50 can be found in the Functional Safety Manual.

### Turning the housing

The housing can be turned to align the display or the cable glands

1. Loosen the locking screw by 0.5 to 1.5 turns (**max.**)
2. Turn the housing

3. Tighten the locking screw with 0.7 Nm

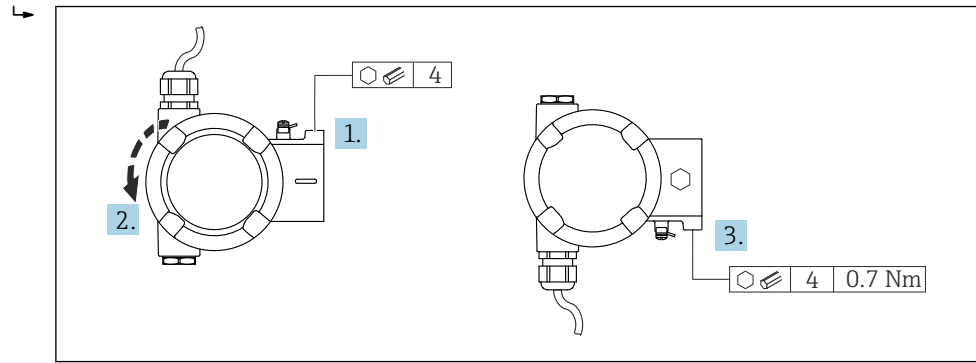

A0042093

- i** Depending on the application, the cable gland may have to point downwards. The cable gland and dummy plug can be swapped for this purpose.

Tighten the cable gland with maximum 3.75 Nm.

## 4.2.2 Dimensions, weights

### Gammapilot FMG50

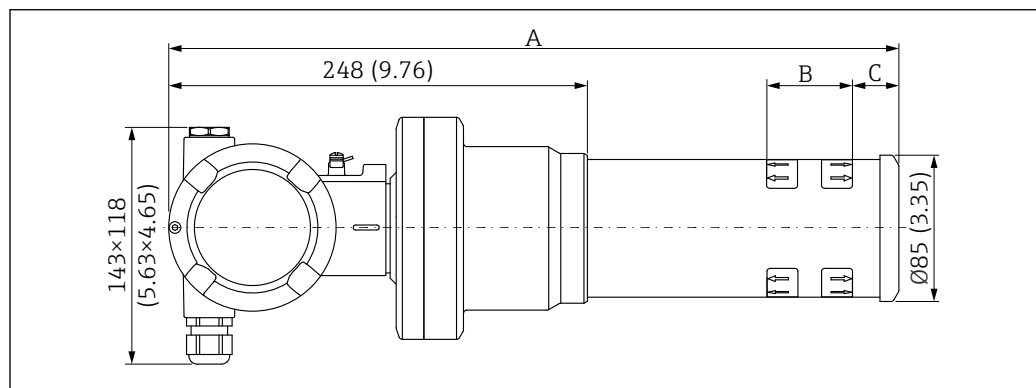

A0037984

- **Version NaI (Tl) 2" :**
  - Total length A: 430 mm (16.93 in)
  - Total weight: 11.60 kg (25.57 lb)
  - Measuring range length B: 51 mm (2 in)
  - Distance C: 24 mm (0.94 in)
- **Version NaI (Tl) 4" :**
  - Total length A: 480 mm (18.90 in)
  - Total weight: 12.19 kg (26.87 lb)
  - Measuring range length B: 102 mm (4 in)
  - Distance C: 24 mm (0.94 in)
- **Version NaI (Tl) 8" :**
  - Total length A: 590 mm (23.23 in)
  - Total weight: 13.00 kg (28.63 lb)
  - Measuring range length B: 204 mm (8 in)
  - Distance C: 30 mm (1.18 in)
- **Version PVT 200 :**
  - Total length A: 590 mm (23.23 in)
  - Total weight: 12.10 kg (26.68 lb)
  - Measuring range length B: 200 mm (8 in)
  - Distance C: 41 mm (1.61 in)

- **Version PVT 400 :**
  - Total length A: 790 mm (31.10 in)
  - Total weight: 13.26 kg (29.23 lb)
  - Measuring range length B: 400 mm (16 in)
  - Distance C: 41 mm (1.61 in)
- **Version PVT 800 :**
  - Total length A: 1 190 mm (46.85 in)
  - Total weight: 15.54 kg (34.26 lb)
  - Measuring range length B: 800 mm (32 in)
  - Distance C: 41 mm (1.61 in)
- **Version PVT 1200 :**
  - Total length A: 1 590 mm (62.60 in)
  - Total weight: 17.94 kg (39.55 lb)
  - Measuring range length B: 1 200 mm (47 in)
  - Distance C: 41 mm (1.61 in)
- **Version PVT 1600 :**
  - Total length A: 1 990 mm (78.35 in)
  - Total weight: 20.14 kg (44.40 lb)
  - Measuring range length B: 1 600 mm (63 in)
  - Distance C: 41 mm (1.61 in)
- **Version PVT 2000 :**
  - Total length A: 2 390 mm (94.09 in)
  - Total weight: 22.44 kg (49.47 lb)
  - Measuring range length B: 2 000 mm (79 in)
  - Distance C: 41 mm (1.61 in)
- **Version PVT 2400 :**
  - Total length A: 2 790 mm (109.84 in)
  - Total weight: 24.74 kg (54.54 lb)
  - Measuring range length B: 2 400 mm (94 in)
  - Distance C: 41 mm (1.61 in)
- **Version PVT 3000 :**
  - Total length A: 3 390 mm (133.46 in)
  - Total weight: 28.14 kg (62.04 lb)
  - Measuring range length B: 3 000 mm (118 in)
  - Distance C: 41 mm (1.61 in)

 The weight data refer to the stainless steel housing versions. The aluminum housing versions are 2.5 kg (5.51 lb) lighter.

 The additional weight for small parts is: 1 kg (2.20 lb)

### Gammapilot FMG50 with collimator

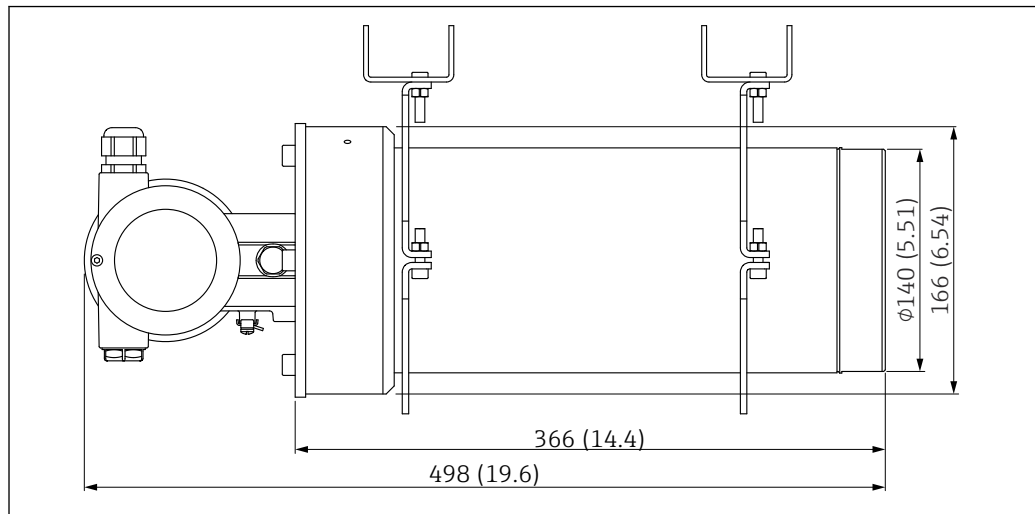

A0045933

2 Version NaI (TI) 2" with collimator on sensor side

#### Version NaI (TI) 2" with collimator on sensor side:

- Total length: 498 mm (19.6 in)
- Weight of collimator (excluding FMG50 and excluding mounted parts): 25.5 kg (56.2 lb)

**i** The additional weight for small parts is: 1 kg (2.20 lb)

### 4.2.3 Installation conditions for level measurement

#### Conditions

- The Gammapilot FMG50 is mounted vertically for level measurements.
- To facilitate installation and commissioning, the Gammapilot FMG50 can be configured and ordered with an additional support (order feature 620, option Q4: "Retaining bracket").

Examples

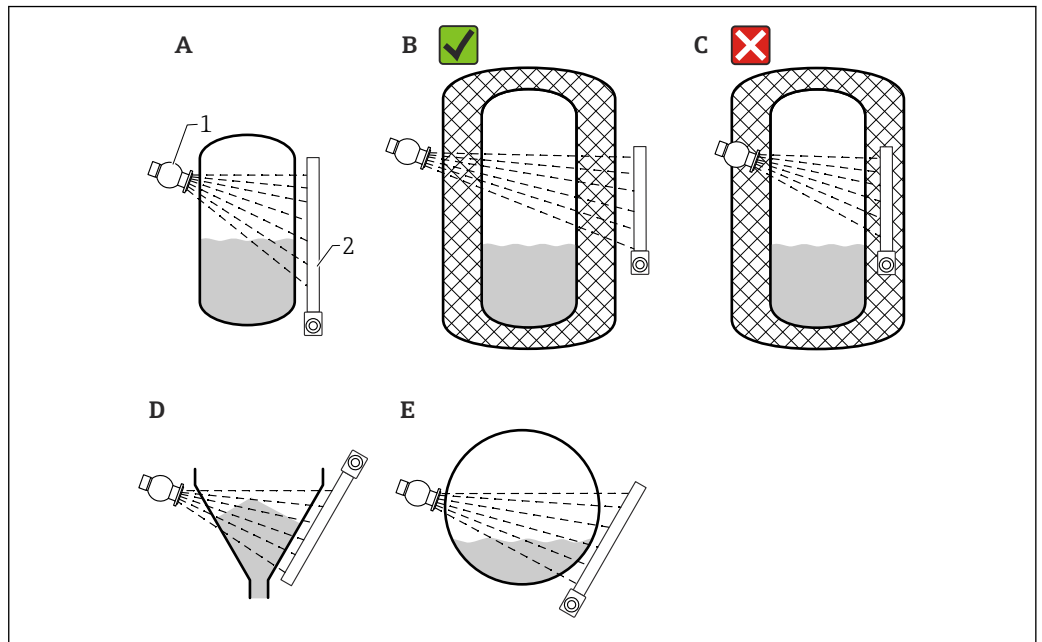

A0037715

- A Vertical cylinder; the Gammapiilot FMG50 is mounted vertically with the detector head pointing either downwards or upwards, the gamma radiation is aligned to the measuring range.
- B Correct: Gammapiilot FMG50 mounted outside the tank insulation
- C Incorrect: Gammapiilot FMG50 mounted inside the tank insulation
- D Conical tank outlet
- E Horizontal cylinder
- 1 Source container
- 2 Gammapiilot FMG50

4.2.4 Installation conditions for point level detection

Conditions

For point level detection, the Gammapiilot FMG50 is generally mounted horizontally at the height of the desired level limit.

Measuring system arrangement

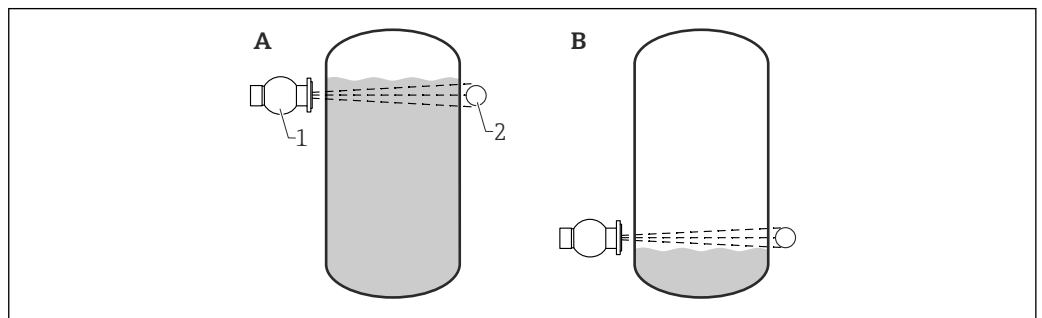

A0018075

- A Maximum point level detection
- B Minimum point level detection
- 1 Source container
- 2 Gammapiilot FMG50

## 4.2.5 Installation conditions for density measurement

### Conditions

- If possible, density should be measured on vertical pipes with forward flow from bottom to top.
- If only horizontal pipes are accessible, the path of the beam should also be arranged horizontally to minimize the influence of air bubbles and deposits.
- The Endress+Hauser clamping device or an equivalent clamping device should be used to fasten the source container and the Gammapilot FMG50 to the measuring pipe. The clamping device itself must be installed in such a way as to withstand the weight of the source container and the Gammapilot FMG50 under all anticipated operating conditions.
- The sample point may not be further than 20 m (66 ft) from the measuring point.
- The distance of the density measurement to pipe bends is  $\geq 3 \times$  pipe diameter, and  $\geq 10 \times$  pipe diameter in the case of pumps.

### Measuring system arrangement

The arrangement of the source container and the Gammapilot FMG50 depends on the pipe diameter (or the radiated length) and the density measuring range. These two parameters determine the measuring effect (relative change in the pulse rate). The longer the radiated length, the greater the measuring effect. Therefore, it is advisable to use diagonal irradiation or a measuring path for small pipe diameters.

To select the measuring system arrangement please contact the Endress+Hauser sales organization or use the Applicator™ configuration software. <sup>1)</sup>

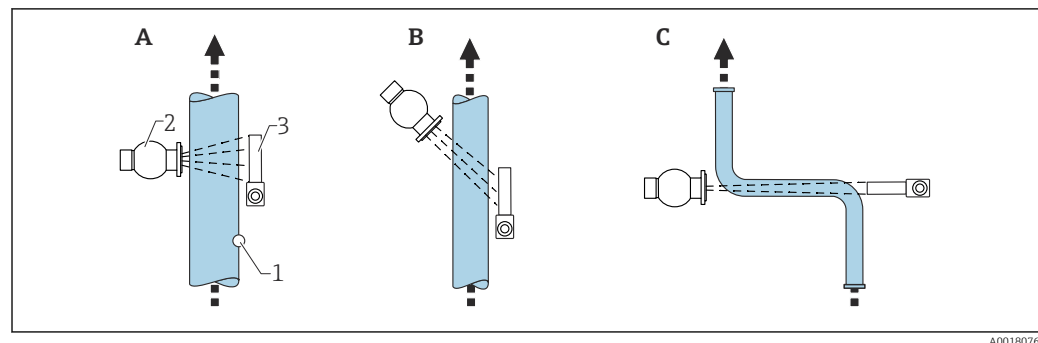

- A Vertical beam (90°)  
 B Diagonal beam (30°)  
 C Measuring path  
 1 Sample point  
 2 Source container  
 3 Gammapilot FMG50

- **i** To increase the accuracy of density measurements, the use of a collimator is recommended. The collimator screens the detector against background radiation.
- When planning, the total weight of the measuring system must be taken into consideration.
- An FHG51 clamping device is available as an accessory

1) The Applicator™ is available from your Endress+Hauser sales organization.



## 4.2.6 Installation conditions for interface measurement

### Conditions

For interface measurement, the Gammapilot FMG50 is typically mounted horizontally at the upper or lower limit of the interface range. When introducing a radiation source into an immersion tube, it is important to ensure that the measuring range is already filled with medium in order to keep the radiation in the vicinity of the source as low as possible. When a radiation source is used in an immersion tube, the radiation can be aligned with the measuring range of the Gammapilot FMG50 using a collimator on the immersion tube.

### Measuring system arrangement

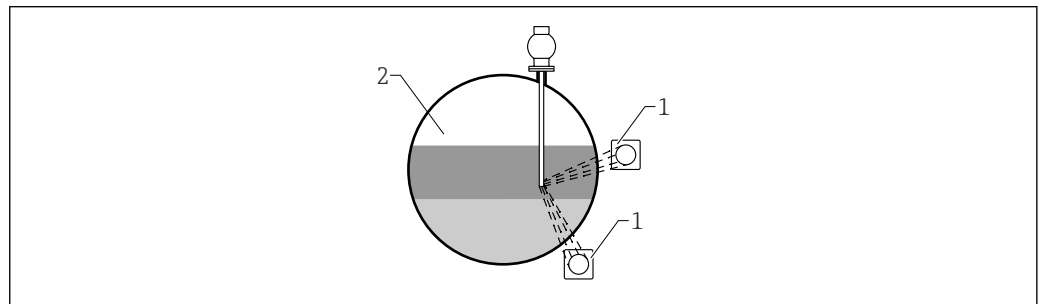

- 1 Gammapilot (2 pcs)  
2 Interface measurement

A0038167

### Description

The measuring principle is based on the fact that the radiation source emits radiation which is attenuated when it penetrates a material and the medium to be measured. In radiometric interface measurement, the radiation source is often introduced into a closed immersion tube via a cable extension. This excludes the possibility of contact between the radiation source and the medium.

Depending on the measuring range and the application, one or several detectors are mounted on the outside of the vessel. The average density of the medium between the radiation source and the detector is calculated from the radiation received. A direct correlation to the position of the interface can then be derived from this density value.

**For more information, see:**



CP01205F

## 4.2.7 Installation conditions for density profile measurement (DPS)

### Conditions

For density profile measurement, Gammapilot FMG50 devices are installed horizontally at defined distances, depending on the size of the measuring range. In the case of density profile measurement, the radiation source is normally inserted in an immersion tube, preferably one that is double-walled, and introduced into the vessel. When introducing a radiation source into an immersion tube, it is important to ensure that the measuring range is already filled with medium in order to keep the radiation in the vicinity of the source as low as possible.

### Measuring system arrangement

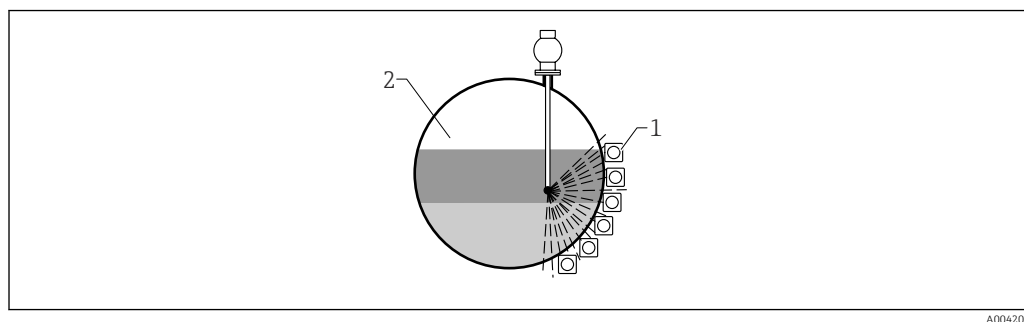

A0042063

- 1 Arrangement of multiple FMG50 units  
2 Density profile measurement

### Description

To obtain detailed information on the distribution of layers of different densities in a vessel, a density profile is measured using a multi-detector solution. Several FMG50 units are installed next to one another on the outside of the vessel wall for this purpose. The measuring range is divided into zones and each compact transmitter measures the density value in its respective zone. A density profile is derived from these values.

This results in a high-resolution measurement of the distribution of medium layers (e.g. in separators)

For more information, see:



CP01205F

## 4.2.8 Installation conditions for concentration measurement

### Conditions

- If possible, the concentration should be measured on vertical pipes with forward flow from bottom to top.
- If only horizontal pipes are accessible, the path of the beam should also be arranged horizontally to minimize the influence of air bubbles and deposits.
- The Endress+Hauser FHG51 clamping device or an equivalent clamping device should be used to fasten the source container and the Gammapilot FMG50 to the measuring pipe. The clamping device itself must be installed in such a way as to withstand the weight of the source container and the Gammapilot FMG50 under all anticipated operating conditions.
- The sample point may not be further than 20 m (66 ft) from the measuring point.
- The distance of the density measurement to pipe bends is  $\geq 3 \times$  pipe diameter, and  $\geq 10 \times$  pipe diameter in the case of pumps.

### Measuring system arrangement

The arrangement of the source container and the Gammapilot FMG50 depends on the pipe diameter (or the radiated length) and the density measuring range. These two parameters determine the measuring effect (relative change in the pulse rate). The longer the radiated length, the greater the measuring effect. Therefore, it is advisable to use diagonal irradiation or a measuring path for small pipe diameters.

To select the measuring system arrangement please contact the Endress+Hauser sales organization or use the Applicator™ configuration software. <sup>2)</sup>

2) The Applicator™ is available from your Endress+Hauser sales organization.

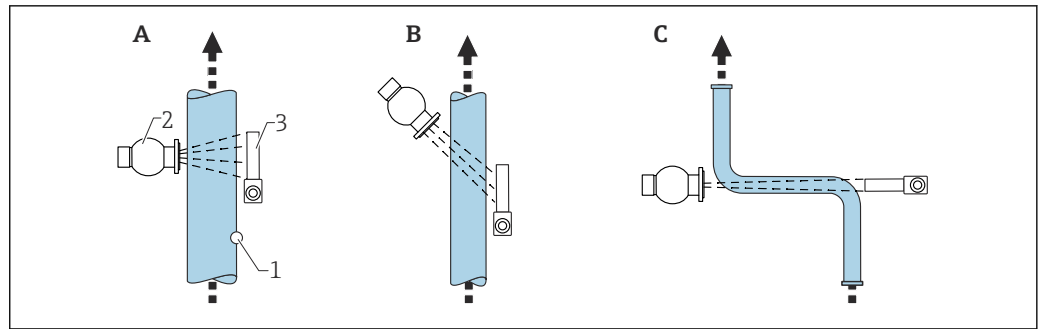

A0018076

- A Vertical beam (90°)  
 B Diagonal beam (30°)  
 C Measuring path  
 1 Sample point  
 2 Source container  
 3 Gammapilot FMG50

-  When planning, the total weight of the measuring system must be taken into consideration.
- An FHG51 clamping device is available as an accessory

#### 4.2.9 Installation conditions for concentration measurement with radiating media

##### Measurement of the concentration of radiating media in vessels

The concentration of radiating media in vessels can be determined by taking a measurement at the vessel wall or in an immersion tube in the vessel. The intensity of the radiation received is proportional to the concentration of the radiating medium in the vessel. It is important to note that the medium in the vessel also absorbs its own radiation. The detected radiation will not increase further with larger diameters and the signal is saturated. This saturation length depends on the half-value layer of the material.

The level in the vessel must be constant in the vicinity of the detector to ensure the measurement is correct.

##### Measurement of the mass flow of radiating media

In the case of belt scales and pipes, the concentration of the radiating medium can be measured in the sample. Here, the device is mounted above or below the conveyor belt so that it is parallel to the belt direction, or is mounted on the pipe. The intensity of the radiation received is proportional to the concentration of the radiating medium in the conveyed material.

#### 4.2.10 Installation conditions for flow measurement

##### Measurement of mass flow (liquids)

The density signal determined by the Gammapilot FMG50 is transmitted to the Promag 55S. The Promag 55S measures the volume flow; the Promag can determine a mass flow in connection with the calculated density value.

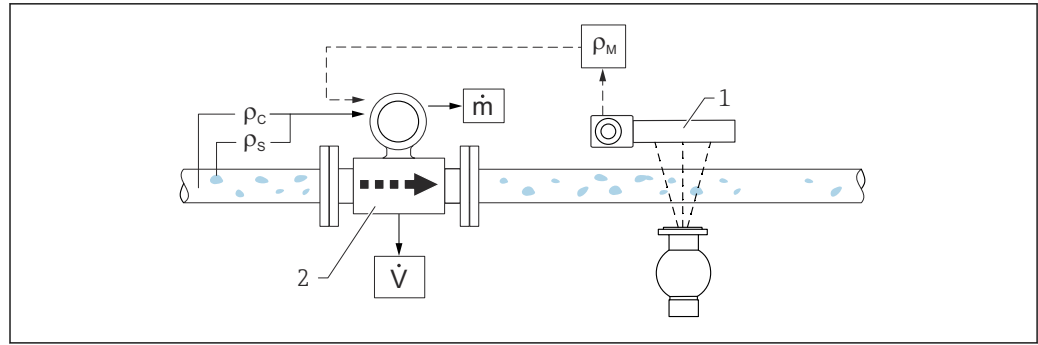

A0018093

3 Mass flow measurement ( $\dot{m}$ ) using a density meter and a flowmeter. If the density of the solids ( $\rho_s$ ) and the density of the carrier liquid ( $\rho_c$ ) are also known, the solids flow rate can be calculated.

1 Gammapilot FMG50 -> total density ( $\rho_m$ ) consisting of the carrier liquid and solids

2 Flowmeter (Promag 55S) -> volume flow ( $\dot{V}$ ). The solids density ( $\rho_s$ ) and the density of the carrier liquid ( $\rho_c$ ) also have to be entered in the transmitter

### Measurement of mass flow (solids)

Bulk solids applications on conveyor belts and conveyor screws.

The source container is positioned above the conveyor belt and the Gammapilot FMG50 below the conveyor belt. The radiation is attenuated by the medium on the conveyor belt. The intensity of the radiation received is proportional to the density of the medium. The mass flow is calculated from the belt speed and the radiation intensity.

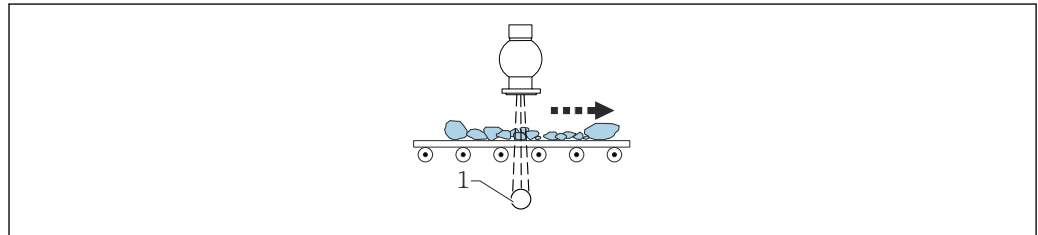

A0036637

1 Gammapilot FMG50

## 4.3 Post-installation check

After installing the measuring device, carry out the following checks:

- Is the device damaged (visual inspection)?
- Does the device match the measuring point specifications (ambient temperature, measuring range etc.)?
- If available: are the measuring point number and labeling correct (visual inspection)?
- Is the measuring device sufficiently protected against sunlight?
- Are the cable glands tightened correctly?

## 5 Electrical connection

### 5.1 Connection compartment

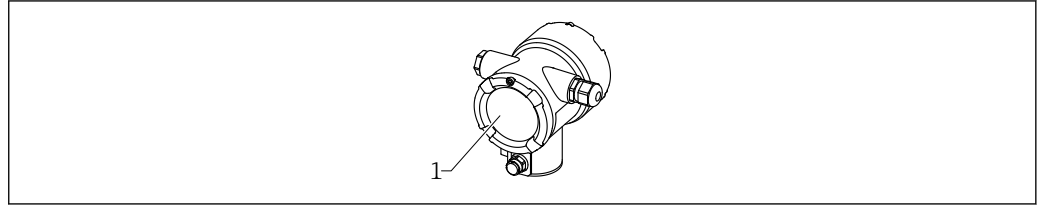

A0038877

1 Connection compartment

### 5.2 4 to 20 mA HART connection

Connection of the device with HART communication, power source and 4 to 20 mA display

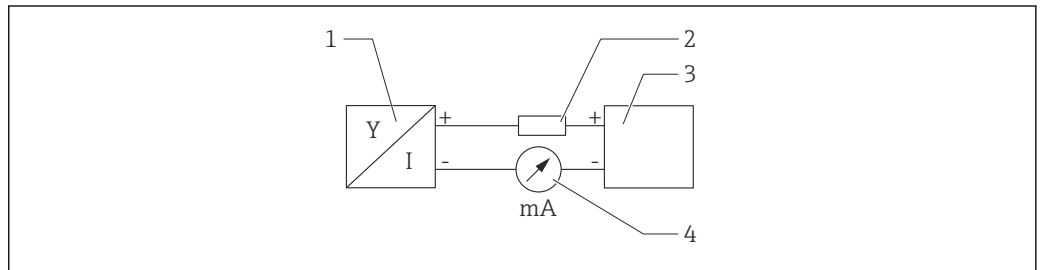

A0028908

4 Block diagram of HART connection

- 1 Device with HART communication
- 2 HART resistor
- 3 Power supply
- 4 Multimeter or ammeter

**i** The HART communication resistor of 250  $\Omega$  in the signal line is always necessary in the case of a low-impedance power supply.

**The voltage drop to be taken into account is:**  
Max. 6 V for 250  $\Omega$  communication resistor

### 5.3 Terminal assignment

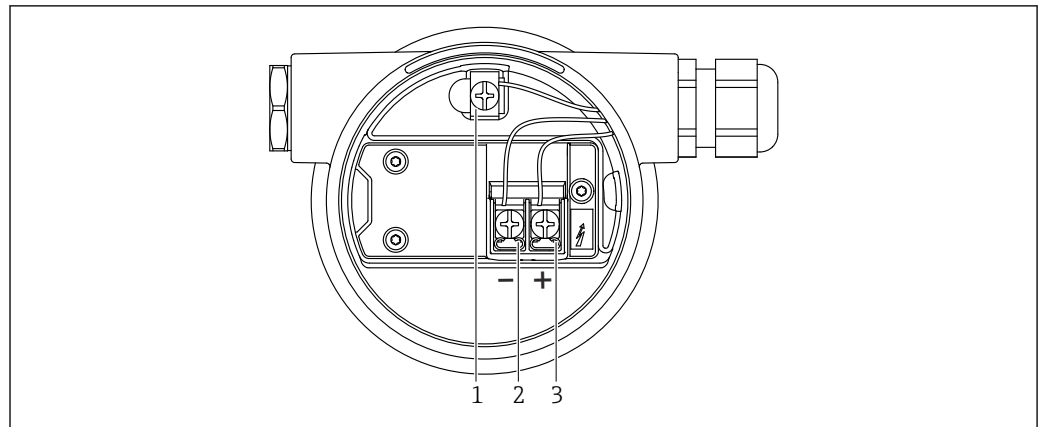

5 Connection terminals and ground terminal in the connection compartment

- 1 Internal ground terminal (to ground the cable shield)
- 2 Negative terminal
- 3 Positive terminal

- Non-Ex: supply voltage: 14 to 35 VDC
- Ex-i: supply voltage: 14 to 30 VDC

### 5.4 Cable entries

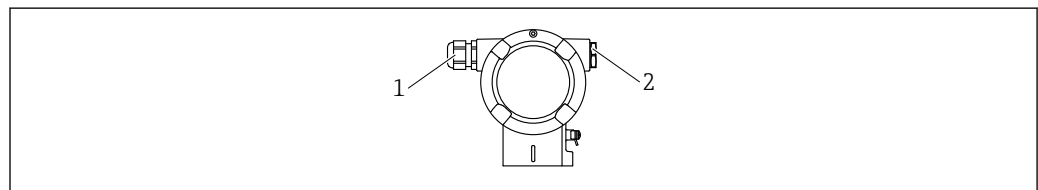

- 1 Cable entry
- 2 Dummy plug

The number and type of cable entries depend on the device version ordered. The following are possible:

- M20 threaded joint, plastic, IP66/68 NEMA Type 4X/6P
- M20 threaded joint, nickel-plated brass, IP66/68 NEMA Type 4X/6P
- M20 threaded joint, 316L, IP66/68 NEMA Type 4X/6P
- M20 thread, IP66/68 NEMA Type 4X/6P
- G1/2 thread, IP66/68 NEMA Type 4X/6P, with enclosed M20 to G1/2 adapter
- NPT1/2 thread, IP66/68 NEMA Type 4X/6P
- M12 plug, IP66/68 NEMA Type 4X/6P
- HAN7D plug, 90 deg. IP65 NEMA Type 4x

**i** Connecting cables should be routed away from the housing from below to prevent moisture from penetrating the connection compartment. Otherwise, a drip loop should be provided or a weather protection cover should be used.

**i** Please follow the enclosed installation instructions if a G1/2 entry is used.

### 5.5 Potential equalization

**Before wiring**, connect the potential matching line to the ground terminal.

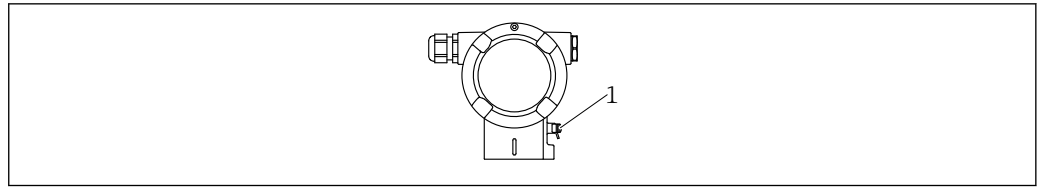

A0038024

1 Ground terminal for connecting the potential matching line

**CAUTION**

▶ Please refer to the separate documentation on applications in hazardous areas for the safety instructions

**i** For optimum electromagnetic compatibility, the potential matching line should be as short as possible and at least 2.5 mm<sup>2</sup> (14 AWG) in cross-section.

### 5.6 Overvoltage protection (optional)

**Product structure, feature 610 "Accessory mounted", option "NA"**

- Overvoltage protection:
  - Nominal functioning DC voltage: 600 V
  - Nominal discharge current: 10 kA
- Surge current check  $\hat{i} = 20$  kA satisfied as per DIN EN 60079-14: 8/20  $\mu$ s
- Arrester AC current check I = 10 A satisfied

**NOTICE**

**Device could be destroyed!**

▶ Devices with integrated overvoltage protection must be grounded.

### 5.7 Rated cross-section

Protective ground or grounding of the cable shield: rated cross-section > 1 mm<sup>2</sup> (17 AWG)

Rated cross-section of 0.5 mm<sup>2</sup> (AWG20) to 2.5 mm<sup>2</sup> (AWG13)

### 5.8 Fieldbus connectors

In the case of device versions with a fieldbus connector, the housing does not have to be opened to establish the connection.

#### 5.8.1 Pin assignment for connector M12-A

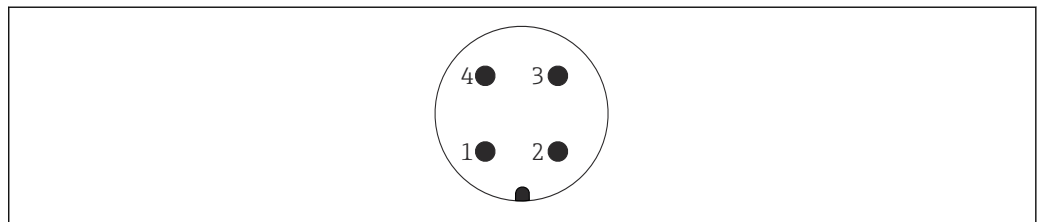

A0011175

- Pin 1: Signal +
- Pin 2: Not used
- Pin 3: Signal -
- Pin 4: Ground

Material: CuZn, contacts for plug-in jack and connector are gold-plated

### 5.8.2 Connection of devices with Harting plug Han7D

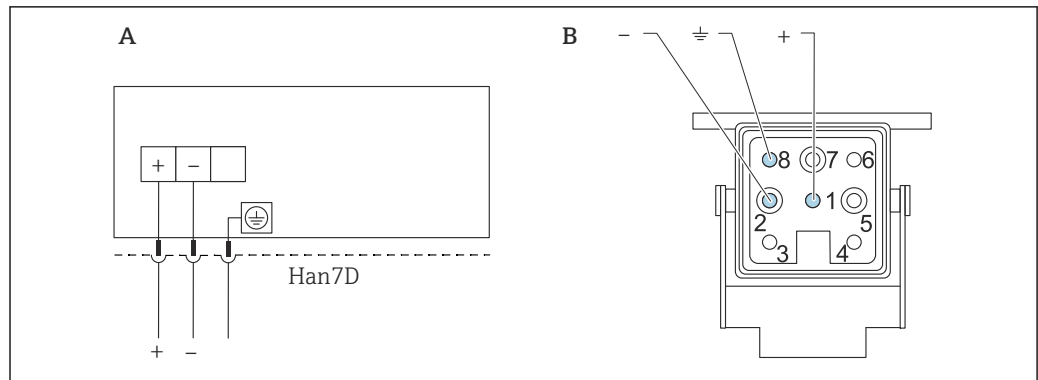

A0019990

A Electrical connection for devices with Harting plug Han7D

B View of the plug-in connection on the device

Material: CuZn, contacts for plug-in jack and connector are gold-plated



## 5.9 FMG50 with RIA15

 The RIA15 remote indicator can be ordered together with the device.

**Product structure, feature 620 "Accessory enclosed":**

- Option PE "Remote indicator RIA15, non-hazardous area, aluminum field housing"
- Option PF "Remote indicator RIA15, hazardous, aluminum field housing"

 Alternatively available as an accessory, for details see Technical Information TI01043K and Operating Instructions BA01170K

**CAUTION**

► Pay attention to the Safety Instructions (XAs) when using the Gammapilot FMG50 with the remote indicator RIA15 in hazardous environments:

- 
  - XA01028R
  - XA01464K
  - XA01056K
  - XA01368K
  - XA01097K

**Terminal assignment RIA15**

- +  
Positive connection, current measurement
- -  
Negative connection, current measurement (without backlighting)
- LED  
Negative connection, current measurement (with backlighting)
- $\perp$   
Functional grounding: terminal in housing

 The RIA15 process indicator is loop-powered and does not require any external power supply.

**The voltage drop to be taken into account is:**

- ≤1 V in the standard version with 4 to 20 mA communication
- ≤1.9 V with HART communication
- and an additional 2.9 V if display light is used

### 5.9.1 Connection of the HART device and RIA15 without backlighting

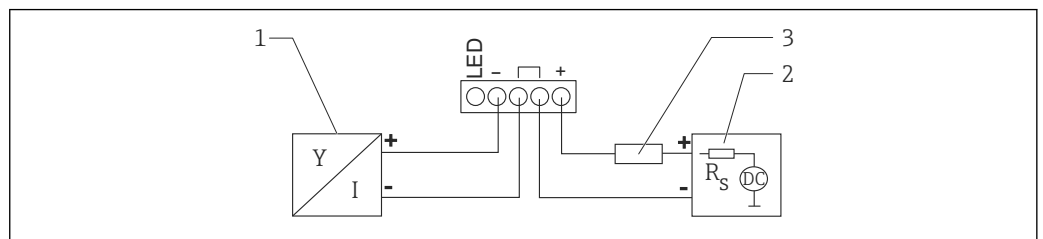

 6 Block diagram of HART device with RIA15 process indicator without light

- 1 Device with HART communication
- 2 Power supply
- 3 HART resistor

### 5.9.2 Connection of the HART device and RIA15 with backlighting

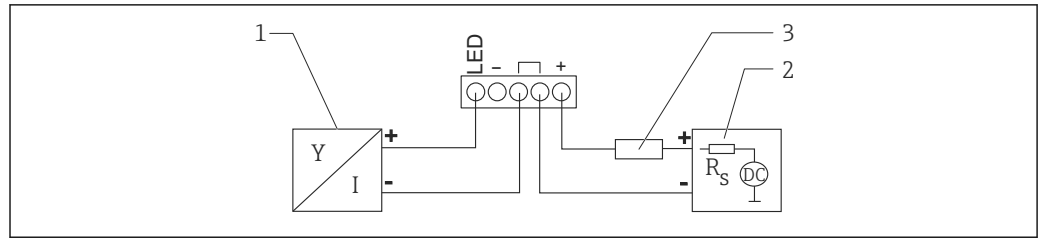

A0019568

7 Block diagram of HART device with RIA15 process indicator with light

- 1 Device with HART communication
- 2 Power supply
- 3 HART resistor

### 5.9.3 FMG50, RIA15 with installed HART communication resistor module

**i** The HART communication module for installation in the RIA15 can be ordered together with the device.

**Product structure, feature 620 "Accessory enclosed":**  
Option PI "HART communication resistor for RIA15"

**The voltage drop to be taken into account is:**  
Max. 7 V

**📖** Alternatively available as an accessory, for details see Technical Information TI01043K and Operating Instructions BA01170K

### Connection of the HART communication resistor module, RIA15 without backlighting

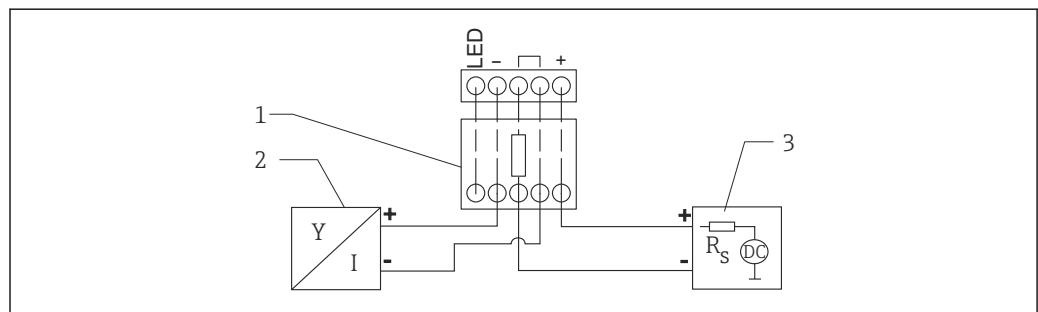

A0020839

8 Block diagram of HART device, RIA15 without light, HART communication resistor module

- 1 HART communication resistor module
- 2 Device with HART communication
- 3 Power supply

### Connection of the HART communication resistor module, RIA15 with backlighting

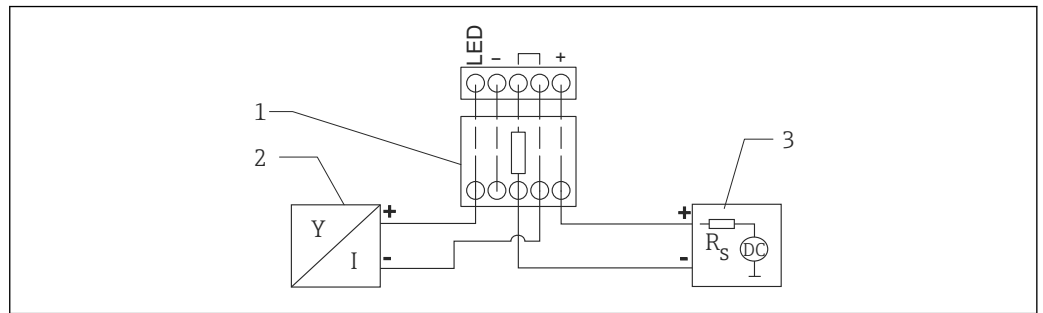

9 Block diagram of HART device, RIA15 with light, HART communication resistor module

- 1 HART communication resistor module
- 2 Device with HART communication
- 3 Power supply

## 5.10 Wiring

### ⚠ CAUTION

#### Note the following before connecting:

- ▶ If the device is used in hazardous areas, make sure to comply with national standards and the specifications in the Safety Instructions (XAs). The specified cable gland must be used.
- ▶ The supply voltage must match the specifications on the nameplate.
- ▶ Switch off the supply voltage before connecting the device.
- ▶ Connect the potential matching line to the external ground terminal of the transmitter before connecting the device.
- ▶ Connect the protective ground to the protective ground terminal.
- ▶ The cables must be adequately insulated, with due consideration given to the supply voltage and the overvoltage category.
- ▶ The connecting cables must offer adequate temperature stability, with due consideration given to the ambient temperature.

1. Release the cover lock
2. Unscrew the cover
3. Guide the cables into the cable glands or cable entries
4. Connect the cables
5. Tighten the cable glands or cable entries so that they are leak-tight
6. Screw the cover securely back onto the connection compartment
7. Tighten the cover lock

#### **i** Housing thread

The thread of the electronics and connection compartment is coated with lubricant varnish.

- ⊗ Avoid additional lubrication.

## 5.11 Wiring examples

### 5.11.1 Point level measurement

The output signal is linear between free and covered adjustment (e.g. 4 to 20 mA) and can be evaluated in the control system. If a relay output is needed, the following Endress+Hauser process transmitters can be used:

- RTA421: for non-Ex applications, without WHG (German Water Resources Act), without SIL
- RMA42: for Ex-applications, with SIL certificate, with WHG

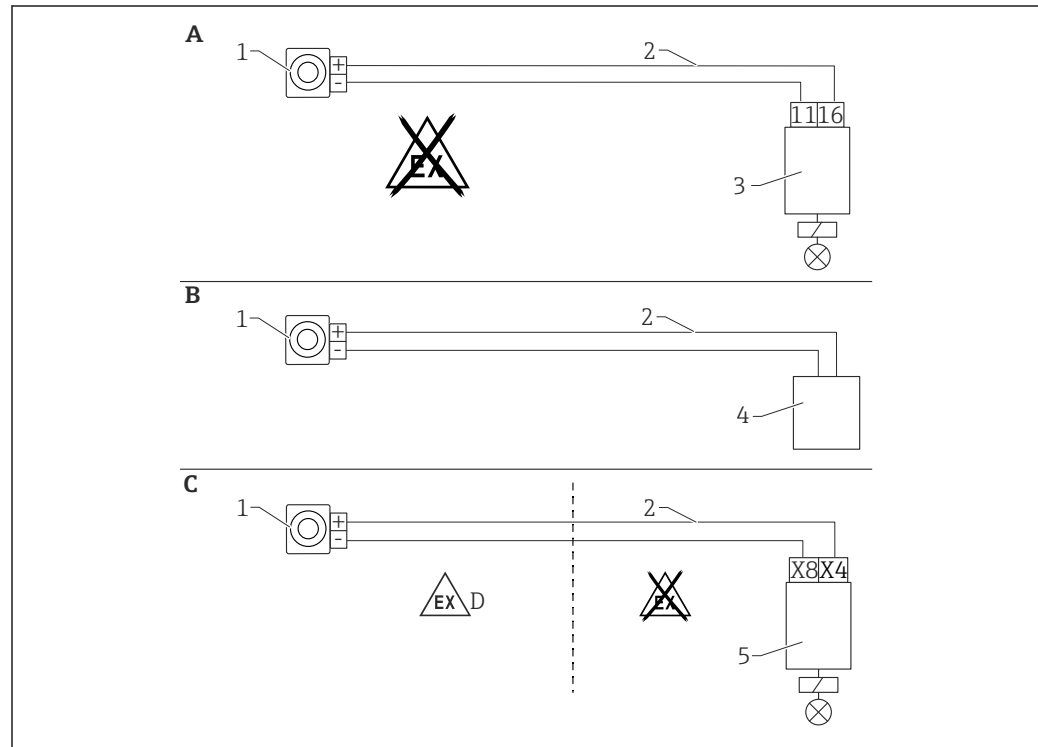

A0018092

- A Wiring with RTA421 switching unit  
 B Wiring with control system (pay attention to the explosion protection regulations)  
 C Wiring with RMA42 switching unit  
 D When installing in hazardous areas, please observe the corresponding Safety Instructions  
 1 Gammapilot FMG50  
 2 4 to 20 mA  
 3 RTA421  
 4 PLC (pay attention to the explosion protection regulations)  
 5 RMA42

### 5.11.2 Cascade mode with 2 FMG50 units

#### Level measurement: FMG50 with RMA42 process transmitter

##### Conditions requiring several FMG50 units:

- Large measuring ranges
- Special tank geometry

Two FMG50 units can be interconnected and powered via one RMA42 process transmitter. The individual output currents are added; this gives the total output current.

**i** The internal HART resistor of the RMA42 is used for HART communication. HART communication with the FMG50 is possible via the front terminals of the RMA42.

**i** Avoid overlap between the individual measuring ranges as this can result in an incorrect measured value. The devices can overlap provided this does not affect the measuring ranges.

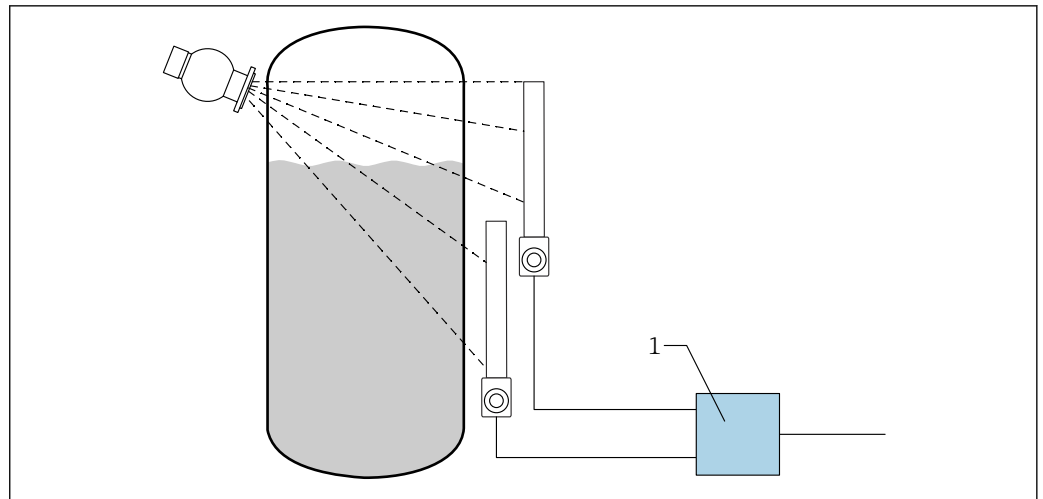

**10** Connection diagram: for two FMG50 units connected to one RMA42

1 RMA42

### Sample settings for cascade mode

► FMG50 settings:

- ↳ All FMG50 units used in cascade must be adjusted individually. For example via the "Commissioning" Wizard in the "Level" operating mode.

The following example refers to a cascade measurement with 2 detectors:

Detector 1: 800 mm measuring range

Detector 2: 400 mm measuring range

**1.** Settings for RMA42 (analog input 1):

- ↳ Signal type: current
- Range: 4 to 20 mA
- Lower range value: 0 mm
- Upper range value: 800 mm
- Offset where applicable

**2.** Settings for RMA42 (analog input 2):

- ↳ Signal type: current
- Range: 4 to 20 mA
- Lower range value: 0 mm
- Upper range value: 400 mm
- Offset where applicable

**3.** Calculated value 1:

- ↳ Calculation: sum total
- Unit: mm
- Bar graph 0: 0 m
- Bar graph 100: 1.2 m
- Offset where applicable

**4.** Analog output:

- ↳ Assignment: calculated value 1
- Signal type: 4 to 20 mA
- Lower range value: 0 m
- Upper range value: 1.2 m

**i** Only the current output of the RMA42 supplies the level measured value of the overall system. No HART values available for the entire cascade.

For more information, see:

 BA00287R

### 5.11.3 Cascade mode with more than 2 FMG50 units



#### Level measurement: FMG50 with Memograph M RSG45

##### Conditions requiring several FMG50 units:

- Large measuring ranges
- Special tank geometry

More than two FMG50 units (maximum 20) can be interconnected and powered via one Memograph M RSG45. The pulse rates (cnt/s) of the individual FMG50 units are added together and linearized; this gives the total level.

To enable the application, the settings must be made on every FMG50. In this way, the actual level in the vessel can be determined over all the anticipated cascade areas. While the calculation is the same for all FMG50 devices in the cascade, the constants for every FMG50 unit vary and must remain editable.

-  The cascade mode requires at least 2 FMG50 units that communicate with the RSG45 via the HART channel.
-  Avoid overlap between the individual measuring ranges as this can result in an incorrect measured value. The devices can overlap provided this does not affect the measuring ranges.

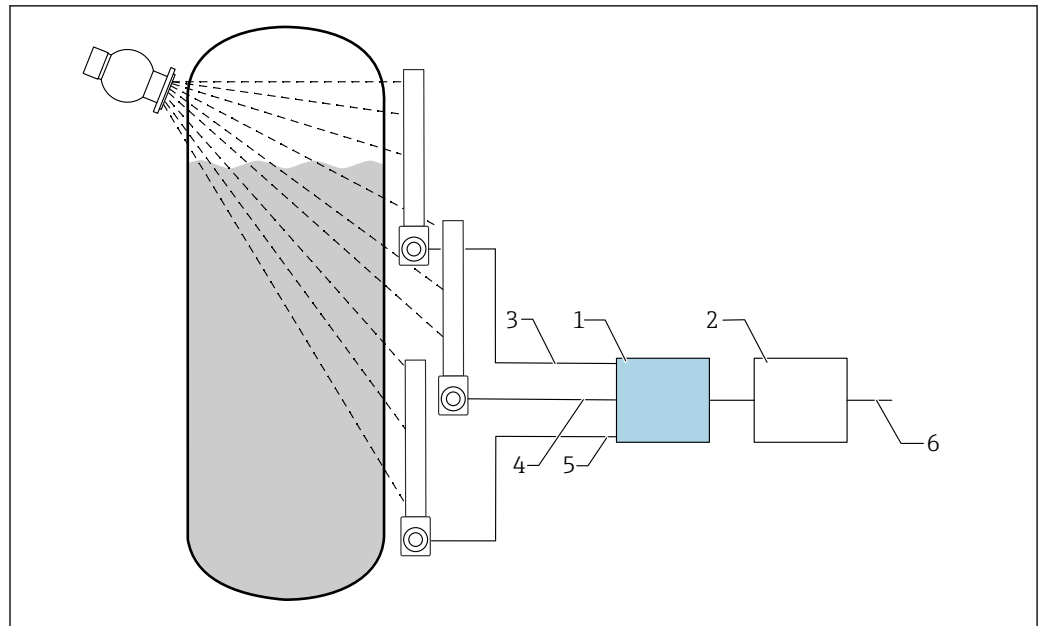

 11 Connection diagram: for three FMG50 units (up to 20 FMG50s) connected to one RSG45

- 1 RSG45
- 2 Algorithm: addition of the individual pulse rates ( $SV_1 + SV_2 + SV_3$ ) and subsequent linearization
- 3 HART signal FMG50 (1), PV\_1: level, SV\_1: pulse rate (cnt/s)
- 4 HART signal FMG50 (2), PV\_2: level, SV\_2: pulse rate (cnt/s)
- 5 HART signal FMG50 (3), PV\_3: level, SV\_3: pulse rate (cnt/s)
- 6 Overall output signal

#### Settings

All FMG50 units used in cascade must be adjusted individually. This is possible via the "Commissioning" Wizard for example

1. Select the "Level" operating mode for all the FMG50 units

2. Configure the HART variable PV (Primary Value) as "Level"
  - ↳ PV (level) is not relevant for the calculation
3. Configure the HART variable SV (Secondary Value) as "Pulse rate"
  - ↳ SV (pulse rate) is relevant for the calculation
4. Connect HART channels with the RSG45
5. Edit the linearization table in the RSG45
  - ↳ Value pairs (max. 32): pulse rate of cascade (total pulse rate) to cascaded level (total level)

 The pulse rates (cnt/s) of all the FMG50 units in the cascade are added in the RSG45 and then linearized

*Example of a linearization table*

Linearization point	Total pulse rate cnt/s	Total level %
21	0	100
20	39	95
19	82	90
18	129	85
17	178	80
16	230	75
15	283	70
14	338	65
13	394	60
12	451	55
11	507	50
10	562	45
9	614	40
8	671	35
7	728	30
6	784	25
5	839	20
4	892	15
3	941	10
2	981	5
1	1013	0

 Determine value pairs during commissioning

### 5.11.4 Ex applications in conjunction with RMA42

Observe the following Safety Instructions:  
ATEX II (1) G [Ex ia] IIC, ATEX II (1) D [Ex ia] IIIC for RMA42

 XA00095R

### 5.11.5 SIL applications for Gammapilot in connection with RMA42

The Gammapilot FMG50 meets the requirements of SIL2/3 as per IEC 61508, see:



FY01007F

The RMA42 meets SIL2 as per IEC 61508:2010 (Edition 2.0), see the Functional Safety Manual:



SD00025R

## 5.12 Post-connection check

After wiring the device, carry out the following checks:

- Is the potential matching line connected?
- Is the terminal assignment correct?
- Are the cable glands and dummy plugs screwed tight?
- Are the fieldbus connectors properly secured?
- Are the covers screwed down correctly?

### **WARNING**

- ▶ Only operate the device with the covers closed



## 6 Operation

### 6.1 Overview of the HART operating options

#### 6.1.1 Via HART protocol

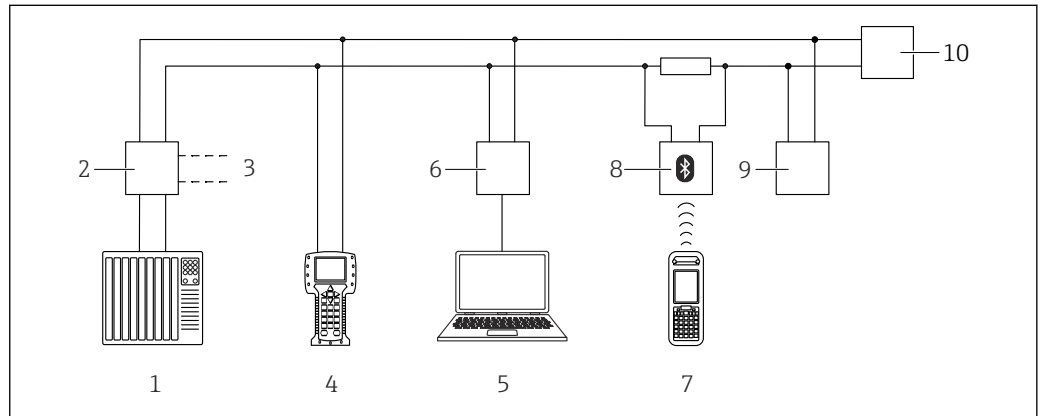

12 Options for remote operation via HART protocol

- 1 PLC (programmable logic controller)
- 2 Transmitter power supply unit, e.g. RN221N (with communication resistor)
- 3 Connection for Commubox FXA191, FXA195 and Field Communicator 375, 475
- 4 Field Communicator 475
- 5 Computer with operating tool (e.g. DeviceCare/FieldCare, AMS Device Manager, SIMATIC PDM)
- 6 Commubox FXA191 (RS232) or FXA195 (USB)
- 7 Field Xpert SFX350/SFX370
- 8 VIATOR Bluetooth modem with connecting cable
- 9 RIA15
- 10 Transmitter

#### 6.1.2 Operation via FieldCare/DeviceCare

FieldCare/DeviceCare is an Endress+Hauser asset management tool based on FDT technology. With FieldCare/DeviceCare you can configure all Endress+Hauser devices as well as devices from other manufacturers that support the FDT standard. Hardware and software requirements can be found on the Internet:

[www.de.endress.com](http://www.de.endress.com) -> Search: FieldCare -> FieldCare -> Technical data

FieldCare supports the following functions:

- Configuration of transmitters in online mode
- Loading and saving device data (upload/download)
- Documentation of the measuring point

Connection options:

- HART via Commubox FXA195 and the USB interface of a computer
- Commubox FXA291 via the service interface

#### 6.1.3 Operation via RIA 15 (remote display)

Loop-powered process indicator to display HART or 4 to 20 mA signals

#### 6.1.4 Operation via WirelessHART

SWA70 WirelessHART adapter with the Commubox FXA195 and the "FieldCare/DeviceCare" operating program

## 6.2 Alternative operation options

The measuring device can be configured and query measured values in a variety of ways.

### 6.2.1 Local operation

The device can also be operated on site using the keys.

If operation is locked using the DIP switches on site, parameter entry via communication is not possible.

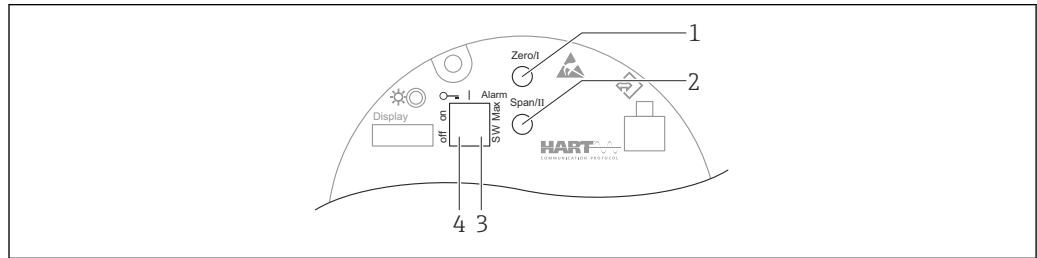

A0039285

- 1 Operating key for empty calibration (function I)
- 2 Operating key for full calibration (function II)
- 3 DIP switch for alarm current (SW-defined/Max. alarm)
- 4 DIP switch for locking and unlocking the measuring device

### 6.2.2 Operation via the service interface

#### DeviceCare/FieldCare via service interface (CDI)

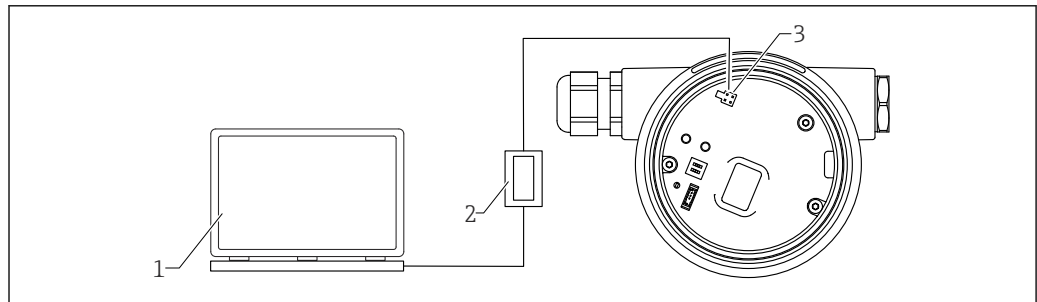

A0038834

13 DeviceCare/FieldCare via service interface (CDI)

- 1 Computer with DeviceCare/FieldCare operating tool
- 2 Commubox FXA291
- 3 Service interface (CDI) of the measuring device (= Endress+Hauser Common Data Interface)

### 6.2.3 Operation via RIA15

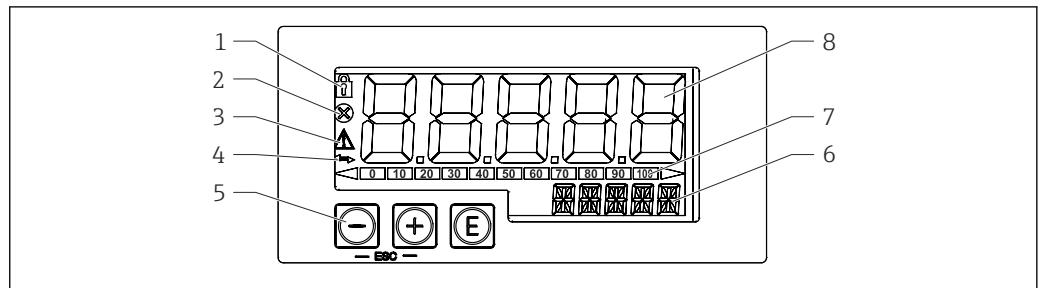

A0017719

 14 Display and operating elements of the process indicator

- 1 Symbol: operating menu disabled
- 2 Symbol: error
- 3 Symbol: warning
- 4 Symbol: HART communication active
- 5 Operating keys
- 6 14-segment display for unit/TAG
- 7 Bar graph with indicators for under range and over range
- 8 5-digit 7-segment display for measured value, digit height 17 mm (0.67 in)

The device is operated using three operating keys on the front of the housing.



Enter key; for calling up the operating menu, confirming the selection/configuration of parameters in the operating menu



Selection and configuration/changing of values in the operating menu; pressing the '+' and '-' keys simultaneously takes the user back up a menu level. The configured value is not saved.



Additional information is available in the Operating Instructions for the RIA15 BA01170K

### 6.2.4 Operation via Bluetooth® wireless technology

#### Requirements

Optional, only for devices with a display with Bluetooth capability:

**Feature 030 "Display, operation", option D "Basic display+Bluetooth"**

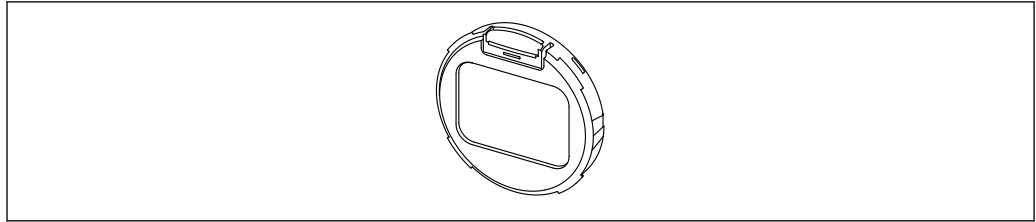

A0039243

15 Display with Bluetooth module

- i** A flashing Bluetooth symbol indicates that a Bluetooth connection is available
- i** Bluetooth communication with the device is possible with a supply voltage of 14 V or higher. The background lighting of the display is only guaranteed with a supply voltage  $\geq 16$  V. The measurement function is guaranteed as of a terminal voltage of 12 V; Bluetooth communication with the device is not possible with this voltage level, however.
- i** If the available supply voltage drops below the aforementioned thresholds during operation, the background lighting switches off first before the Bluetooth function is switched off in order to guarantee the measurement function. A corresponding warning message is not displayed. These functions are reactivated when sufficient power is supplied.

If the available supply voltage was already too low when the device was started these functions are not activated later on.

**Operation via SmartBlue App**

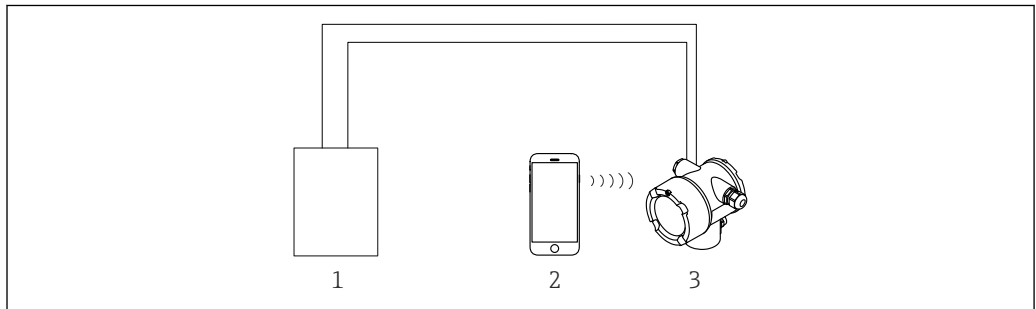

A0038833

16 Operation via SmartBlue App

- 1 Transmitter power supply unit
- 2 Smartphone / tablet with SmartBlue App
- 3 Transmitter with Bluetooth module

**6.2.5 Heartbeat Verification/Monitoring**

- i** The **Heartbeat** submenu is only available if operating via **FieldCare**, **DeviceCare** or **SmartBlue App**. It contains Wizards that are available with the **Heartbeat Verification** and **Heartbeat Monitoring** application packages.

SD02414F

## 6.3 Locking/unlocking configuration

### 6.3.1 Software locking

#### Locking via password in FieldCare / DeviceCare / SmartBlue App

Access to the configuration of the FMG50 can be locked by assigning a password. The "User role" is set to "Maintainer" in the as-delivered state. The device can be fully configured in the "Maintainer" role. Afterwards, access to the configuration can be locked by assigning a password. The "User Role" is now set to "Operator". The configuration can be accessed by entering the password.

The password is defined under:

**System -> User management -> Define password**

You can switch from the "Maintainer" to "Operator" user role under:

**System -> User management -> Logout**

#### Deactivating the lock via FieldCare / DeviceCare / SmartBlue App

After entering the password, you can enable the configuration of the FMG50 as an "Operator" with the password. The "User role" then changes to "Maintainer"

Navigate to:

**System -> User management -> Change user role**

### 6.3.2 Hardware locking

Hardware locking can only be unlocked on the electronic insert (flip the switch). It is not possible to unlock the hardware by communication.

## 6.4 Resetting to the default configuration

### ⚠ CAUTION

- ▶ A reset may negatively impact the measurement. As a rule, a basic setup must be performed again after a reset. All calibration data are deleted after a reset. A complete recalibration is needed to put the measurement back into operation.

1. Connect the device with FieldCare or DeviceCare.
2. Open the device in FieldCare or DeviceCare.
  - ↳ The dashboard (homepage) of the device is displayed:  
Click "System -> Device management"

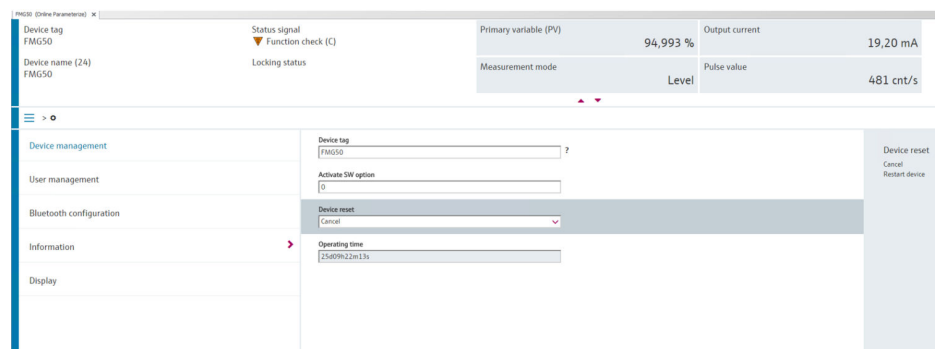

3. Reset the device in the "Device reset" parameter

**The following types of reset can be selected:****■ Restart device**

A soft reset is performed here. The device software performs all the diagnostics that would also be performed by a hard reset by switching the device on/off.

**■ Reset to factory default**

It is always advisable to reset the customer parameters if you want to use a device with an unknown history, or if the operating mode is changed. When a reset is performed, all customer parameters are reset to the factory default values

**■ Optional: reset to customer settings**

If the device was ordered with a customized configuration, a reset restores these customer settings configured at the factory.

 A reset can also be performed on site via the operating keys (see Section 7.4 "Commissioning via onsite operation").

## 7 Commissioning

### 7.1 Post-installation and post-connection check

Perform the post-installation check and the post-connection check for the FMG50 prior to commissioning the measuring point.

- i** Perform commissioning using the Commissioning Wizard!  
If commissioning is performed via the menu, incorrect settings can result in device failure.

### 7.2 Commissioning using the Commissioning Wizard

#### 7.2.1 General information

When the device is switched on for the first time or following a reset to factory settings (see Section 6.4), the device displays the error message **F440 "Device is not calibrated"**, the status signal indicates an alarm and the current output is set to failure current: MIN, -10%, 3.6 mA (factory setting).

A Wizard is available in FieldCare, DeviceCare and the SmartBlue App to guide you through the initial commissioning process.

- i** FieldCare and DeviceCare are available for download. You need to register in the Endress+Hauser software portal to download the application.

<https://www.software-products.endress.com>

- i** SmartBlue enables operation via Bluetooth.

For details, see the "Commissioning via the SmartBlue App" section

- i** The following diagrams show the display in FieldCare or DeviceCare. The displays in other operating tools may differ, but the content is the same.

1. Connect the device with FieldCare, DeviceCare or SmartBlue App (Bluetooth).
2. Open the device in FieldCare, DeviceCare or SmartBlue App.  
↳ The dashboard (homepage) of the device is displayed:

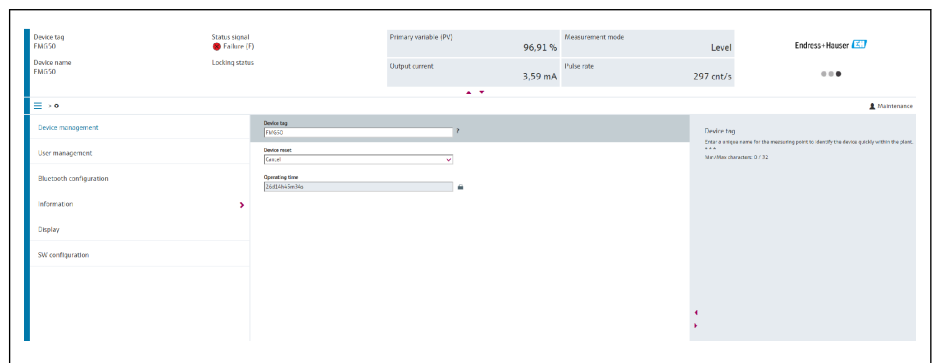

**17** Screenshot: Commissioning Wizard

3. Click "Commissioning" to launch the Wizard.
4. Enter the appropriate value in each parameter or select the appropriate option. These values are written directly to the device.
5. Click "Next" to go to the next page.

6. Once all the pages have been completed, click "Finish" to close the Wizard.

**i** If you cancel the Wizard before all the necessary parameters have been entered, the device may be in an undefined state. In such situations, it is advisable to reset the device to the factory default settings.

The following operating modes can be set via the Wizard:

- Level
- Min. or max. point level
- Density measurement
- Concentration measurement
- Concentration measurement of radiating media

**i** **Configuration of gammagraphy detection:** see Section 8.6

**Recalibration of a density measurement:** see Section 8.7

## 7.2.2 Device identification

The user guidance starts with the general configuration of the tag name and some HART parameter settings.

Device identification | Measurement adjustments | Calibration | Output settings | Finish

**Device tag**  
SIL Testdevice, 27.01.2020 ✓  
Transfer successful

**Device name**  
FMG50

**Serial number (22)**  
R100080119F

**Extended order code**

**Extended order code 1 (25)**

**Extended order code 2 (26)**

**Extended order code 3 (27)**

A0042162

Device identification | Measurement adjustments | Calibration | Output settings | Finish

**HART short tag**  
SIL Test ?

**HART date code**  
2009-07-20

**HART descriptor**  
FMG50

**HART message**  
FMG50

A0042163

## 7.2.3 Measurement settings

After this, the general "measurement settings" of the Gammapiot FMG50 can then be made:



The screenshot shows the 'Measurement adjustments' settings page. At the top, a progress bar indicates the current step is 'Measurement adjustments'. Below the progress bar, the following settings are visible:

- Measurement mode:** Level
- Calibration or Linearization type:** Standard
- Calibration time:** 300 s
- Damping output:** 6,0 s
- Temperature unit:** °C

A0042164

The first settings page of the "measurement settings" is displayed for all operating modes.

The following configuration options are available:

- General settings
- Configuration of the reference time
- Selection of the isotope used (depends on the operating mode)
- Selection of the beam type (depends on the operating mode)

### General settings

**i** In the "slave mode" operating mode, no settings are made apart from the setting for the operating mode.

**i** The pulse rate, measured value and current shown on the optional display are also filtered with the configured "Damping output".

1. Selection of the calibration or linearization type
  - ↳ Depends on the operating mode
2. Configuration of the engineering unit for the level
  - ↳ Depends on the "Level" operating mode with customer linearization
3. Configuration of the unit of length
  - ↳ Depends on the operating mode
4. Configuration of the density unit
  - ↳ Depends on the operating mode
5. Configuration of the calibration time
  - ↳ The calibration time is the time to be measured for the calibration of the individual calibration points. This time should be changed depending on the measuring task.
6. Configuration of the output damping
  - ↳ The output damping defines the time constant  $T_{63}$ . The setting depends on the process conditions. Increasing the damping value makes the measured value considerably steadier but also slower. In order to reduce the influence of stirrers or turbulent surfaces, it is advisable to increase the damping value. However, the value selected for damping should not be too large so that rapid changes in the measured value can also be detected quickly.

#### Sample settings for the time constant $T_{63}$ :

Level: 6 s

Density: 60 s

For information about the effect on the current output, see the Technical Information:

**TI01462F**



7. Configuration of the temperature unit  
 ↳ Selection of temperature unit

### Configuration of the reference time

The first time you run the user guidance function, the reference date is entered for calculating the radioactive decay of the radiation source (this is normally the current date).

A0042165

The date of the operating tool is accepted by pressing the "Reference date for decay calculation" button.

-  The real-time clock is already set at the factory and backed by a battery. For more details, see Section 8.8
-  Note: The reference date can only be set once. It is only possible to change the setting by resetting the device to the factory setting, see Section 6.4.

### Selection of the isotope used and the beam type (depends on the operating mode)

A0042166

Once the reference date is set, the isotope used is then selected. The isotope must be selected to be able to compensate for isotope decay correctly

A  $^{137}\text{Cs}$  or  $^{60}\text{Co}$  source acts as the radiation source. Alternatively, radiation sources with other decay constants can also be used. The decay time can be defined as between 1 and 65536 days. Decay times for other isotopes can be found in the "NIST Standard Reference Database 120", see:

<https://www.nist.gov/pml/radionuclide-half-life-measurements/radionuclide-half-life-measurements-data>

If no decay compensation is selected, the Gammapiot FMG50 determines the measured variable without any compensation.

If a gamma modulator FHG65 is used for interference radiation suppression, "modulated" must be selected for the beam type. If the Gammapiot FMG50 is used without the gamma modulator FHG65, the default option "not modulated" is left as is.

**⚠ WARNING**

- ▶ If the incorrect beam type or isotope is selected, the Gammapiot FMG50 will output an incorrect measured value. This would be a dangerous undetected failure. It is not permitted to change the setting in the operating menu.

**i** The type of isotope and beam can only be set once. It is only possible to change the setting by resetting the device to the factory setting, see Section 6.4.

## 7.2.4 Calibration

### Background calibration

The background calibration is necessary in order to record the natural background radiation at the mounting position of the Gammapiot FMG50. The pulse rate of this background radiation is automatically subtracted from all other measured pulse rates. Only the part of the pulse rate which originates from the radiation source used is taken into consideration.

In contrast to the radiation of the source used, the background radiation remains more or less constant for the entire duration of the measurement. For this reason, background calibration is not factored into the automatic decay compensation of the Gammapiot FMG50.

1. Select the isotope and the beam type
2. Switch off radiation (source housing set to the "off" position) or fill vessel to the maximum level.
3. Press the "Start background calibration" button

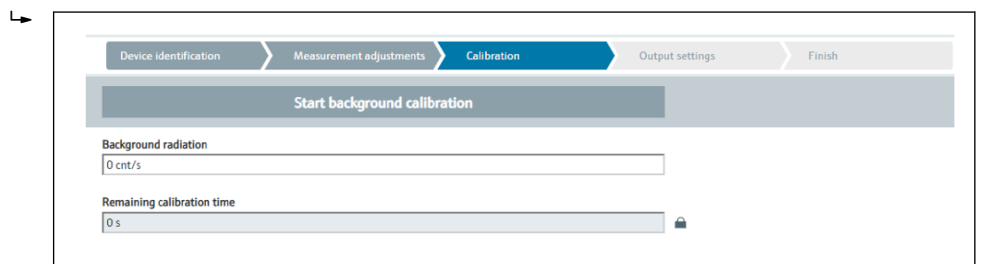

A0042167

The measurement then starts automatically and continues, at the very maximum, for as long as has been configured for the calibration time. However, the process can also be stopped manually by pressing the "Stop calibration" button. The calibration stops automatically as soon as a million pulses have been totalized.

Alternatively, the background value can also be entered directly.

For the "Next" button in the Wizard to be enabled, the value must, however, be changed from the start value, at least temporarily.

**i** In the case of radiating media, the calibration of the background radiation must be performed at the lowest possible radiation (ideally: without a medium)

### Point level calibration

Depends on the operating mode selected.

For a point level measurement, the Gammapiot FMG50 requires two other calibration points in addition to the background calibration:

- Empty calibration
- Full calibration

The correlation between the current output and the calibration values is always linear in the point level operating mode. In this sense, this operating mode is the same as the Level operating mode with the "linear" type of linearization.

1. **Selection:** start with full calibration or start with empty calibration

- ↳ Start calibration -> the calibration can be stopped once the pulse rate has stabilized.

A0042168

2. **Empty calibration point level:** the radiation is switched on and the beam path is completely free

- ↳ If these conditions are met, empty calibration can be started.

A0042169

The empty calibration can be performed by pressing the "Start empty calibration" button. The measurement then starts automatically and continues, at the very maximum, for as long as has been configured for the calibration time. However, the process can also be stopped manually by pressing the "Stop calibration" button.

The calibration stops automatically as soon as a million pulses have been totalized.

Alternatively, the empty calibration can also be entered directly.

For the "Next" button in the Wizard to be enabled, the value must, however, be changed from the start value, at least temporarily.

3. **Full calibration point level:** the radiation is switched on and the beam path is completely covered by medium.
  - ↳ If these conditions are met, the calibration can be started.

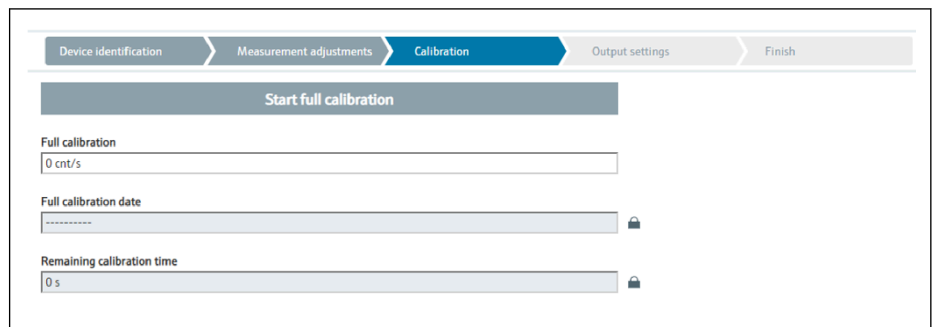

A0042170

The full calibration can be performed by pressing the "Start full calibration" button. The measurement then starts automatically and continues, at the very maximum, for as long as has been configured for the calibration time. However, the process can also be stopped manually by pressing the "Stop calibration" button.

The calibration stops automatically as soon as a million pulses have been totalized.

Alternatively, the full calibration can also be entered directly.

For the "Next" button in the Wizard to be enabled, the value must, however, be changed from the start value, at least temporarily.

**TIP:** if the vessel cannot be filled appropriately, the full calibration can also be performed with the radiation switched off. This is a way of simulating a completely covered radiation path. In this case, full calibration is identical to background calibration and 0 cnt/s is typically displayed.

4. The calibration has been performed successfully.
  - ↳

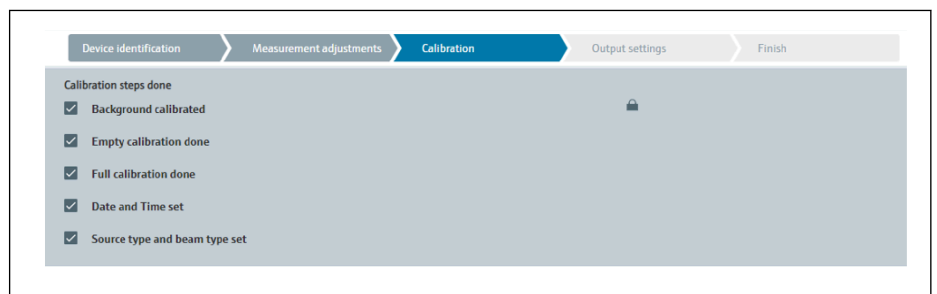

A0042171

5. The settings for the current output are then made in the "Output settings" step

### Level calibration

Depends on the operating mode selected.

For a level measurement, the Gammapilot FMG50 requires at least two other calibration points in addition to the background calibration:

- Empty calibration
- Full calibration

**Linearization level measurement:** the linearization defines the correlation between the pulse rate and the level (0 to 100%).

The Gammapilot FMG50 makes a variety of linearization modes available:

- Pre-programmed linearizations for frequent standard cases ("linear", "standard")
- Entry of any linearization table adapted to the specific application
  - The linearization table consists of up to 32 "normalized pulse rate : level" value pairs.
  - The linearization table must be monotonic decreasing, i.e. a higher pulse rate must always be paired with a lower level.

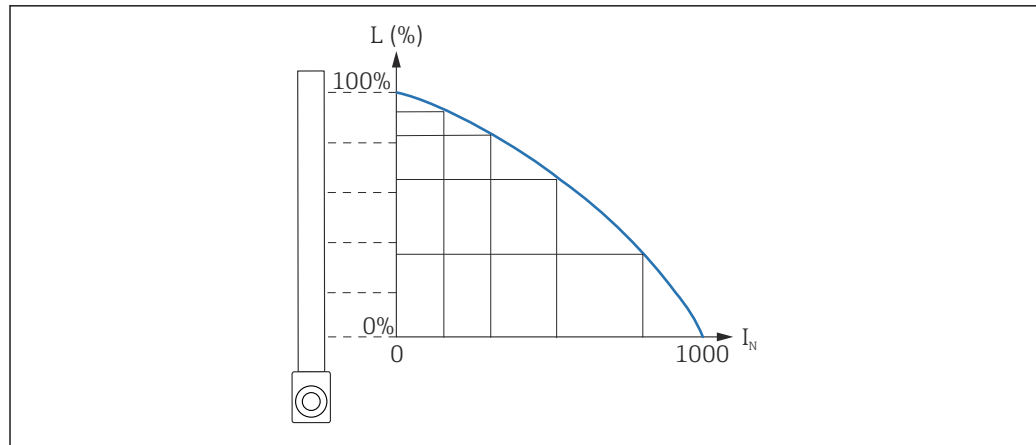

A0040241

18 Example of a linearization curve for level measurements (consisting of 6 value pairs)

$L$  Level

$I_N$  Normalized pulse rate

The type of linearization has already been selected in the "Measurement settings" section

**i** The behavior of the "linear" type of linearization is identical to the "point level calibration" operating mode.

1. **Selection:** start with full calibration or start with empty calibration

↳ Start calibration -> the calibration can be stopped once the pulse rate has stabilized.

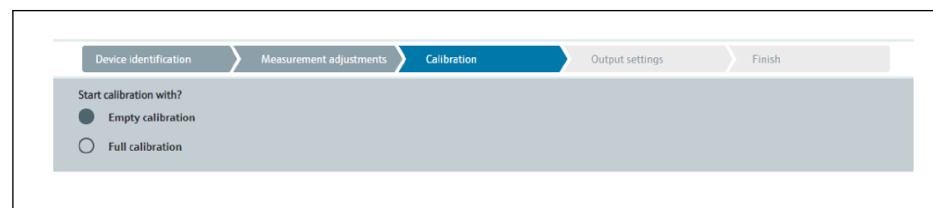

A0042168

**2. Empty calibration level:** the radiation is switched on and the beam path is completely free.

↳ If these conditions are met, empty calibration can be started.

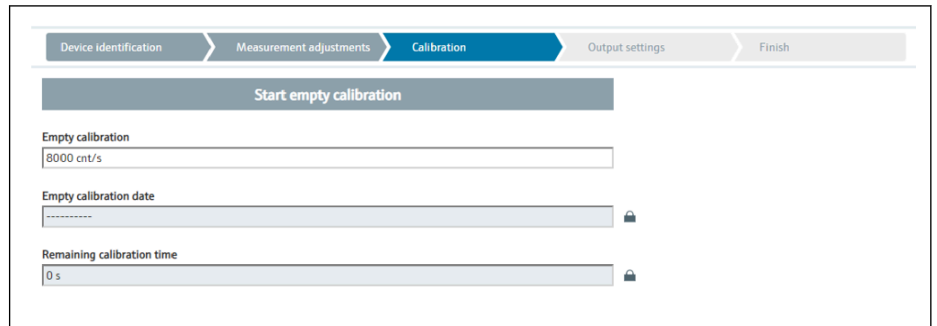

A0042169

The empty calibration can be performed by pressing the "Start empty calibration" button. The measurement then starts automatically and continues, at the very maximum, for as long as has been configured for the calibration time. However, the process can also be stopped manually by pressing the "Stop calibration" button.

The calibration stops automatically as soon as a million pulses have been totalized.

Alternatively, the empty calibration can also be entered directly.

For the "Next" button in the Wizard to be enabled, the value must, however, be changed from the start value, at least temporarily.

**3. Full calibration level:** the radiation is switched on and the beam path is completely covered by medium.

↳ If these conditions are met, the calibration can be started.

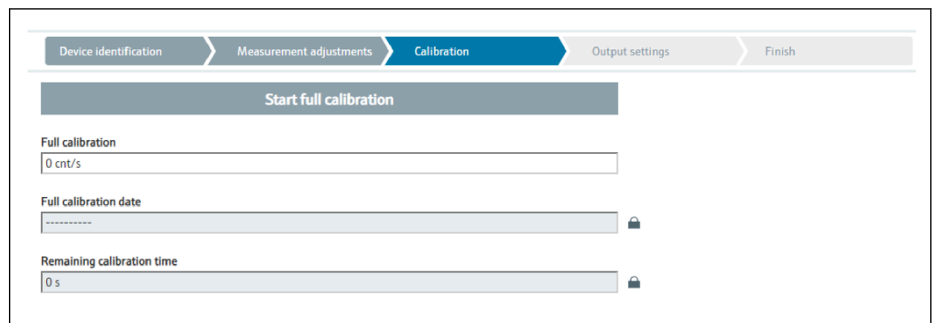

A0042170

The full calibration can be performed by pressing the "Start full calibration" button. The measurement then starts automatically and continues, at the very maximum, for as long as has been configured for the calibration time. However, the process can also be stopped manually by pressing the "Stop calibration" button.

The calibration stops automatically as soon as a million pulses have been totalized.

Alternatively, the full calibration can also be entered directly.

For the "Next" button in the Wizard to be enabled, the value must, however, be changed from the start value, at least temporarily.

**TIP:** if the vessel cannot be filled appropriately, the full calibration can also be performed with the radiation switched off. This is a way of simulating a completely covered radiation path. In this case, full calibration is identical to background calibration and 0 cnt/s is typically displayed.

4. If a customized table has been selected for the linearization, the following input screen appears:

A0042174

The procedure varies depending on the type of table that is selected.

- For the "Normalized pulse rate" table type, see the description for "Normalized pulse rate"
- For the "Semi-automatic" table type, see the description for "Semi-automatic"

**i** If the type of table is subsequently changed, please refer to the "Information on the use of the linearization module with linearization values recorded semi-automatically".

*Normalized pulse rate*

A0042183

N	L	I	I <sub>N</sub>
1	0	2431	1000
2	35	1935	792
3	65	1283	519
4	83	642	250
5	92	231	77
6	100	46	0



*Normalized pulse rate*

Note that the normalized pulse rate is entered in the linearization table. The normalized pulse rate is not identical to the pulse rate actually measured. The correlation between these two variables is defined by:

$$I_N = (I - I_0) / (I_{MAX} - I_0) \times 1000$$

Where:

- $I_0$  is the minimum pulse rate (i.e. the pulse rate for full calibration)
- $I_{MAX}$  is the maximum pulse rate (i.e. the pulse rate for empty calibration)
- $I$ : the measured pulse rate
- $I_N$ : the normalized pulse rate

The normalized pulse rate is used because it does not depend on the activity of the radiation source used:

- For  $L = 0\%$  (empty vessel),  $I_N$  always = 1000
- For  $L = 100\%$  (full vessel)  $I_N$  always = 0

The individual linearization values can be entered via the input screen or via a separate linearization module. The linearization table consists of up to 32 "normalized pulse rate : level" value pairs.

Linearization table conditions

- The table can consist of up to 32 "level - linearized value" pairs.
- The table must decrease monotonically
  - The first value in the table must correspond to the minimum level
  - The last value in the table must correspond to the maximum level

The table values can be sorted as monotonically decreasing using the "Table mode -> Sort table" function.

**Edit table:** the index of the linearization point is entered in this field (1-32 points)

**Customer input value:** enter the normalized pulse rate

**Customer value:** level in unit of length, volume unit or %.



The customer input value in normalized pulse rates and the customer value as a percentage can be determined in the "Applicator" user software. <sup>3)</sup>

**Activate table:** the "Enable" option must first be selected before the linearization table is used. The linearization table is not used as long as "Disable" is selected.

The linearization table can also be entered manually in the linearization module. This is started by selecting the "Linearization" button:

3) The Endress+Hauser Applicator is available online at [www.endress.com](http://www.endress.com)

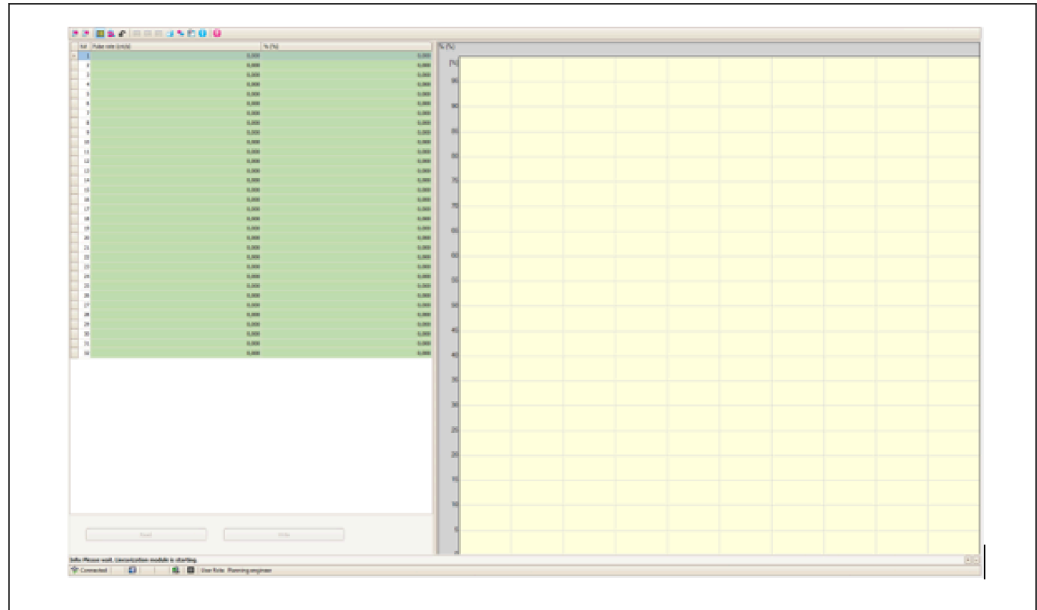

A0042194

The normalized pulse rate and the customer value can be entered directly in table form in this module.

**i** The linearization table must be activated by selecting "Activate table" -> "Enable"

*Semi-automatic*

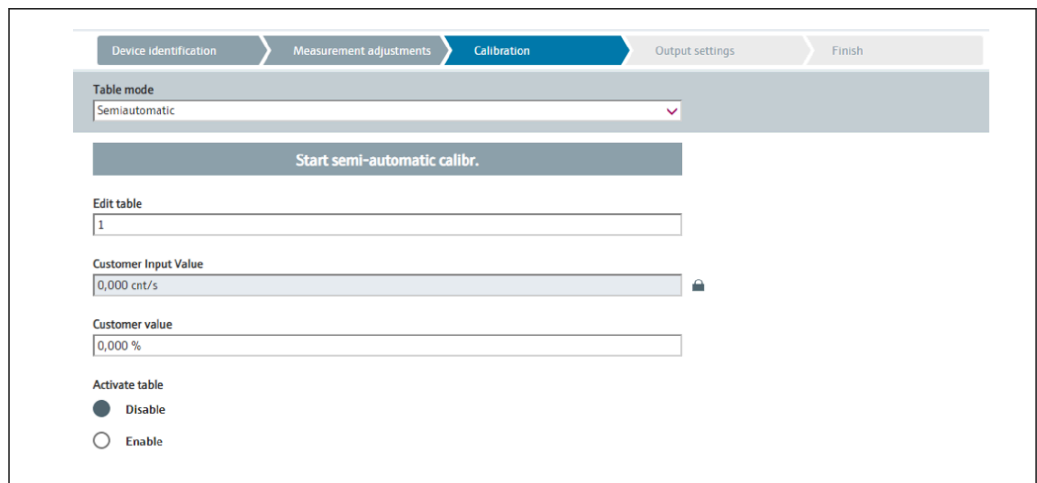

A0042195

During semi-automatic linearization, the device measures the pulse rate for every linearization point. The associated level value is entered manually. In contrast to the normalized pulse rate, the measured pulse rate is directly applied to the linearization table in the semi-automatic mode.

The linearization table consists of up to 32 "measured pulse rate : level" value pairs.

Linearization table conditions

- The table can consist of up to 32 "level - linearized value" pairs.
- The table must decrease monotonically
  - The first value in the table must correspond to the minimum level
  - The last value in the table must correspond to the maximum level

The table values can be sorted as monotonically decreasing using the "Table mode -> Sort table" function.

**Edit table:** the index of the linearization point is entered in this field (1-32 points)

**Customer input value:** measured pulse rate for the linearization point

**Customer value:** level in unit of length, volume unit or %.

**Activate table:** the "Enable" option must first be selected before the linearization table is used. The linearization table is not used as long as "Disable" is selected.

- ▶ To record a new input value, press the "Start semi-automatic calibration" button.
  - ↳ The measurement then starts automatically and continues, at the very maximum, for as long as has been configured for the calibration time. However, the process can also be stopped manually by pressing the "Stop calibration" button. The calibration stops automatically as soon as a million pulses have been totalized.

 The remaining calibration time of the semi-automatic calibration is not displayed on the user interface.

 The linearization table must be activated by selecting "Activate table" -> "Enable"

### Use of the linearization module with linearization values recorded semi-automatically

Please note the following if using the linearization module with linearization tables recorded semi-automatically:

 The module assumes pulse rates are normalized and automatically switches the internal measurement calculation to normalized values if the module is used. This falsifies the assignment between the output value and the measured value. If the linearization module has been opened with semi-automatic linearization curves, the table mode must be set to "semi-automatic" again.

If error F435 "Linearization incorrect" is displayed, the linearization table must be checked again according to the dependencies and conditions mentioned above.

### WARNING

- ▶ The linearization can calculate an incorrect value if the wrong table mode is used. The current output will also output an incorrect measured value in this case.

The following message is displayed following a successful calibration:

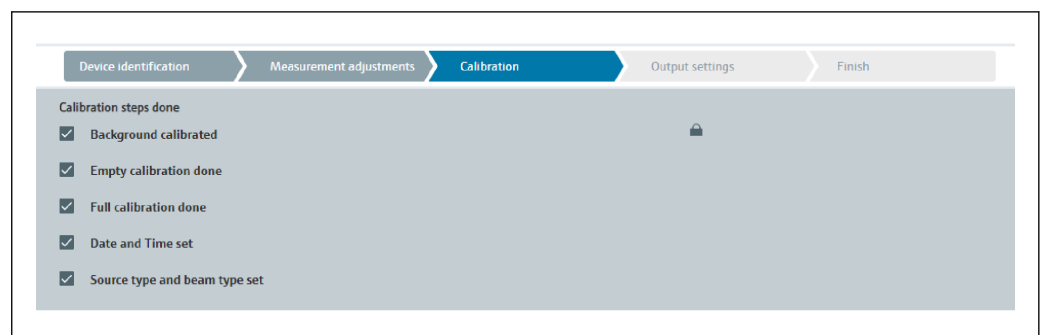

A0042198

The settings for the current output are then made in the "Output settings" step

### Density calibration

Depends on the operating mode selected.

The GammapiLOT FMG50 requires the following parameters for density and concentration measurements:

- The length of the irradiated measuring path
- The absorption coefficient  $\mu$  of the medium
- The reference pulse rate  $I_0$

Two types of calibration are available to determine these parameters:

- Multi-point calibration
- One-point calibration

#### *Multi-point calibration*

Multi-point calibration is recommended particularly for measurements in a large density range or for particularly accurate measurements. Up to 4 calibration points can be used over the entire measuring range. The calibration points should be as far apart as possible and should be evenly distributed over the entire measuring range.

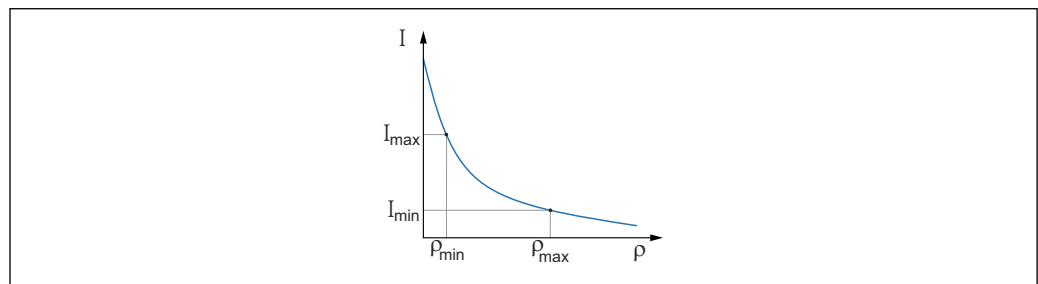

A0042200

$I$  Pulse rate  
 $\rho$  Density

Once the calibration points have been entered, the GammapiLOT FMG50 calculates the reference pulse rate  $I_0$  and the absorption coefficient  $\mu$  parameters on its own.

#### *One-point calibration*

A one-point calibration can be performed if a multi-point calibration is not possible. This means that apart from the background calibration only one additional calibration point is used. This calibration point should be as close as possible to the operating point. Density values near this calibration point are measured quite accurately, but the accuracy can decrease as the distance from the calibration point increases.

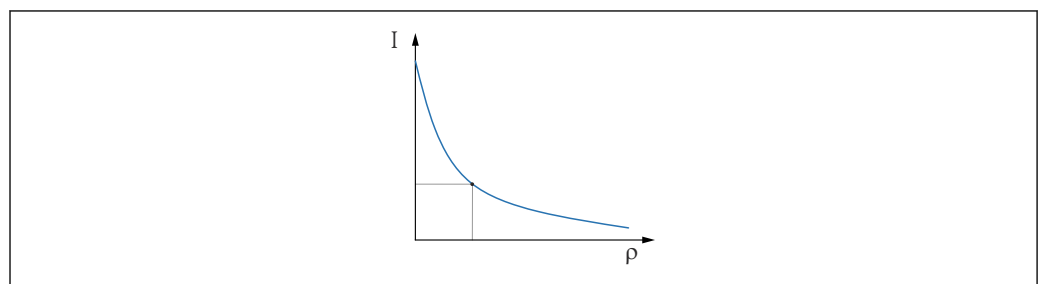

A0042199

$I$  Pulse rate  
 $\rho$  Density

In one-point calibration, the GammapiLOT FMG50 only calculates the reference pulse rate  $I_0$ . For the absorption coefficient  $\mu$ , the device uses a predefined value. This predefined value can be edited directly or an absorption coefficient for the specific measuring point can be determined using the Applicator. The default value for the absorption coefficient is  $\mu = 7.7 \text{ mm}^2/\text{g}$ .

The type of calibration has already been selected in the "Measurement settings" section

**i** The Gammapiot FMG50 does not have a Wizard for **recalibration**. Nevertheless, a recalibration can be performed easily. See "Density recalibration for multi-point calibration"

*Beam path length*

The length of the beam path in the medium to be measured is specified here.

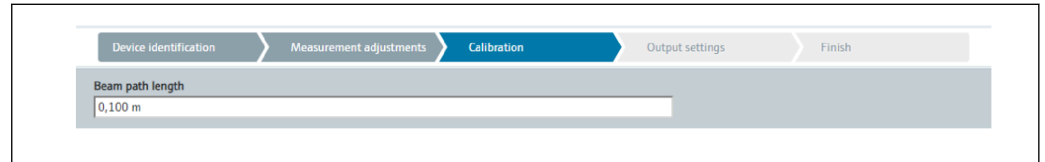

A0042201

Examples:

If the beam passes through the pipe at an angle of 90°, this value corresponds to the internal pipe diameter. If the beam passes through the pipe at an angle of 30° in order to increase the sensitivity of the measurement, the length of the beam path corresponds to twice the internal pipe diameter.

**i** The unit of length can be defined in the "Measurement settings" section

*Multi-point calibration*

Up to four density calibration points can be recorded in a multi-point calibration. The procedure is the same for all four calibration points. The first of the four possible calibration points is described below.

*Calibration density point 1-4*

1. The radiation is switched on and the beam path is filled with medium of a known density.

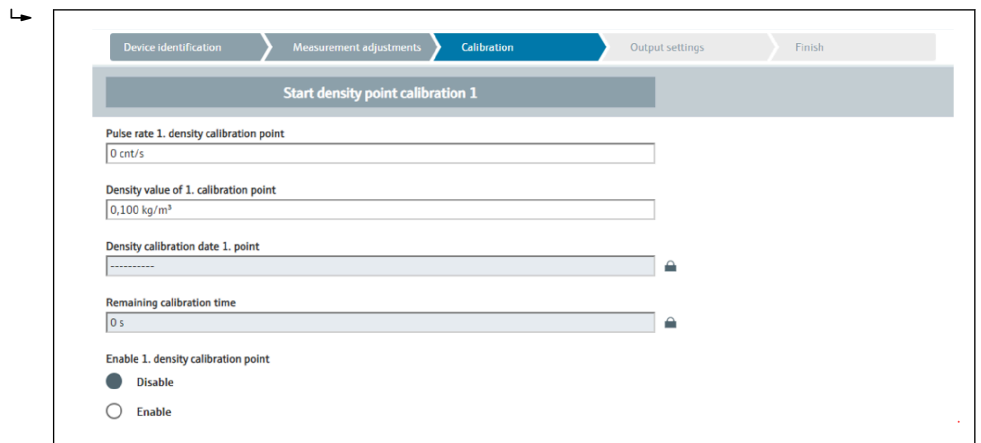

A0042202

The calibration can be performed by pressing the "Start density point calibration" button. The measurement then starts automatically and continues, at the very maximum, for as long as has been configured for the calibration time. However, the process can also be stopped manually by pressing the "Stop calibration" button.

The calibration stops automatically as soon as a million pulses have been totalized.

Alternatively, the pulse rate can also be entered directly.

For the "Next" button in the Wizard to be enabled, the value must, however, be changed from the start value, at least temporarily.

2. With this calibration point, the density of the product is entered in the "Density value of calibration point" field.
  - ↳ This establishes the reference between the determined pulse rate and the density of the product.
 

**TIP:** it is recommended to take a sample of the medium during the integration and determine its density subsequently (e.g. in the laboratory).
3. Activate the density calibration point

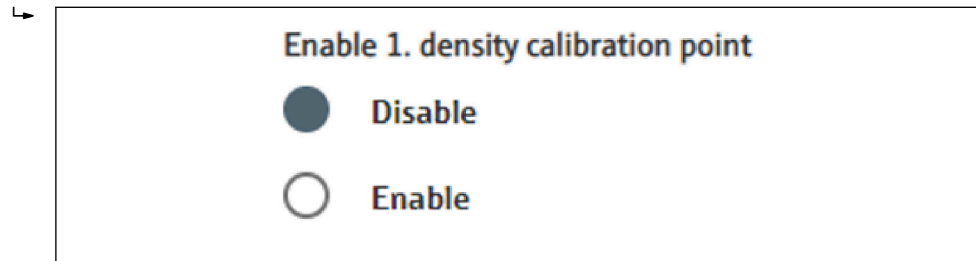

A0042203

- i** At least two of the four available density calibration points must be activated at the end. Three or four points can also be used, however. This increases the accuracy for determining the absorption coefficient  $\mu$  and empty pulse rate  $I_0$ . If the calibration is to be ended after recording 2 density points, you can click the "Next" button to skip density points 3 and 4 without calibrating or activating them. The GammapiLOT FMG50 then ignores these two density points.

The "Calibration date of density point" field provides the user with information on the time the specific calibration value was recorded.



A0042209

- i** In the event of the subsequent calibration of a new density calibration point, a free calibration point can be used and activated or an old measuring point can be overwritten.

#### *One-point calibration*

The user can choose from two different ways to perform the one-point density calibration. The choice is made when the user is asked to "Use the Applicator settings"

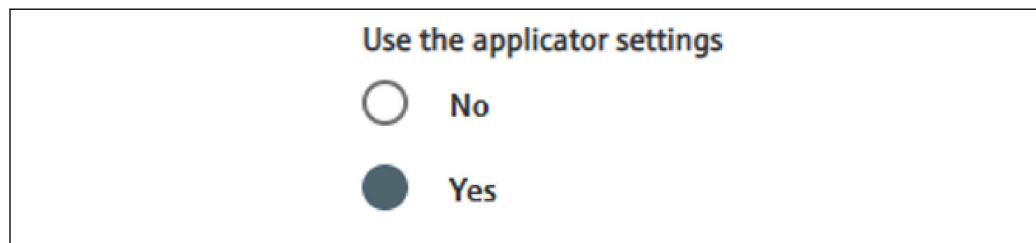

A0042210

#### **"Use the Applicator settings" = No**

A density point is calibrated and the preset absorption coefficient of  $7.7 \text{ mm}^2/\text{g}$  is used to calculate the density values. Here, it is also possible to enter an absorption coefficient if this application-specific value is known for the measurement.

#### **"Use the Applicator settings" = Yes**

The value for the empty pulse rate of the measuring point is calculated in the Endress +Hauser Applicator<sup>4)</sup> and entered here. With this patented process, the Gammapiilot FMG50 can calculate an absorption coefficient on the basis of the specific geometry of the measuring point and therefore calibrate the density measurement.

**Calibration density point 1:**

1. The radiation is switched on and the beam path is filled with medium of a known density. The calibration point should be as close as possible to the operating point of the density measurement.

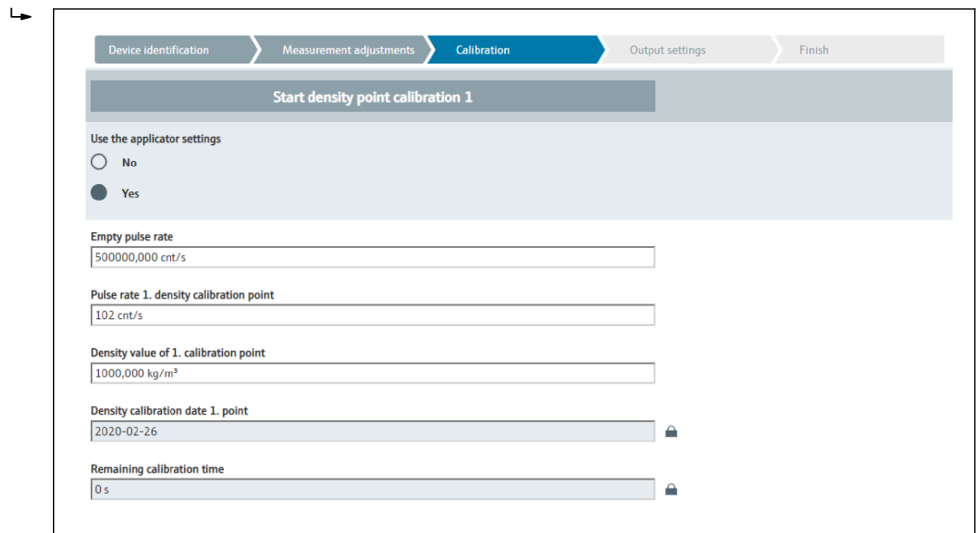

The calibration can be performed by pressing the "Start calibration point 1" button. The measurement then starts automatically and continues, at the very maximum, for as long as has been configured for the calibration time. However, the process can also be stopped manually by pressing the "Stop calibration" button.

The calibration stops automatically as soon as a million pulses have been totalized.

Alternatively, the pulse rate can also be entered directly.

For the "Next" button in the Wizard to be enabled, the value must, however, be changed from the start value, at least temporarily.

2. With this calibration point, the density of the medium is entered in the "Density value of calibration point" field.

↳ This establishes the reference between the determined pulse rate and the density of the product.

**TIP:** it is recommended to take a sample of the medium during the integration and determine its density subsequently (e.g. in the laboratory).

**TIP:** it is not necessary to activate the density point as the density point is activated automatically if only one point exists.

**CAUTION:** in the "Density" operating mode, it is essential to assign the lower limit value (4 mA) and the upper limit value (20 mA) of the current output to the density.

The following message is displayed following a successful calibration:

4) The Endress+Hauser Applicator is available online at [www.endress.com](http://www.endress.com)

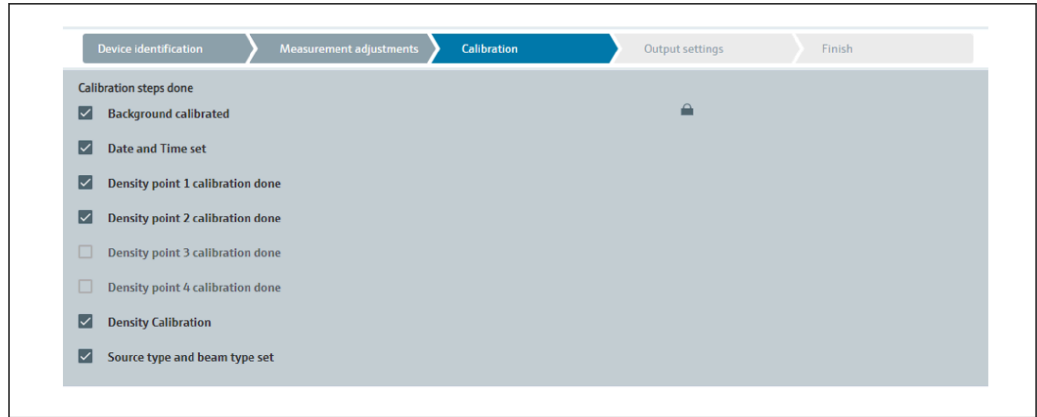

A0042213

The settings for the current output are then made in the "Output settings" step

**Interface**

In the GammapiLOT FMG50, interface measurement is performed by measuring the different densities of two media, such as oil and water. Interface measurement in a calibration is therefore very similar to a multi-point density measurement with two density calibration values.

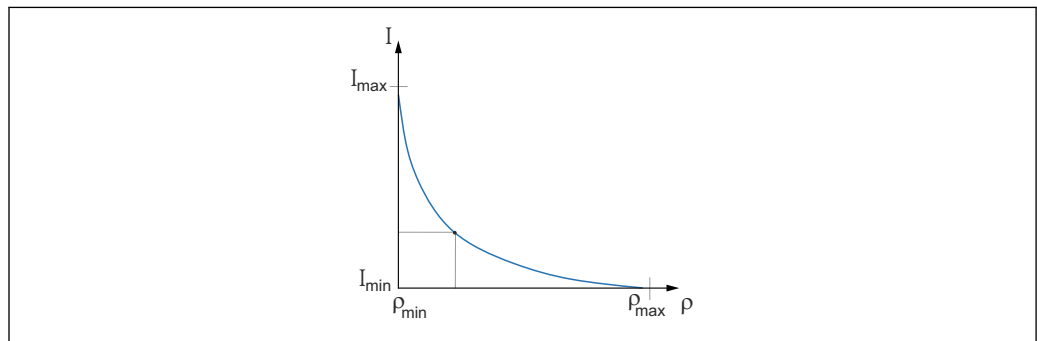

A0042211

- $I$  Pulse rate
- $\rho$  Density
- $I_{min}$  Minimum pulse rate
- $\rho_{min}$  Minimum density, oil
- $I_{max}$  Maximum pulse rate
- $\rho_{max}$  Maximum density, water

Once the calibration points have been entered, the GammapiLOT FMG50 calculates the interface layer in % on its own. Here, 0% corresponds to the minimum density and 100% to the maximum density.

The settings for the current output are then made in the "Output settings" step

*Beam path length*

The length of the beam path in the medium to be measured is specified here.

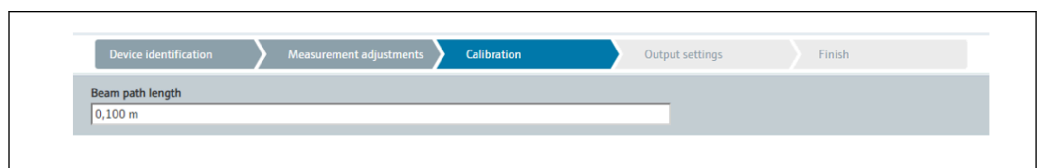

A0042201

Examples:



If the beam passes through the pipe at an angle of 90°, this value corresponds to the internal pipe diameter. If the beam passes through the pipe at an angle of 30° in order to increase the sensitivity of the measurement, the length of the beam path corresponds to twice the internal pipe diameter.

 The unit of length can be defined in the "Measurement settings" section

*Calibration of interface medium 1 / 2*

1. The radiation is switched on and the beam path is covered: only with **Medium 1** or only with **Medium 2**

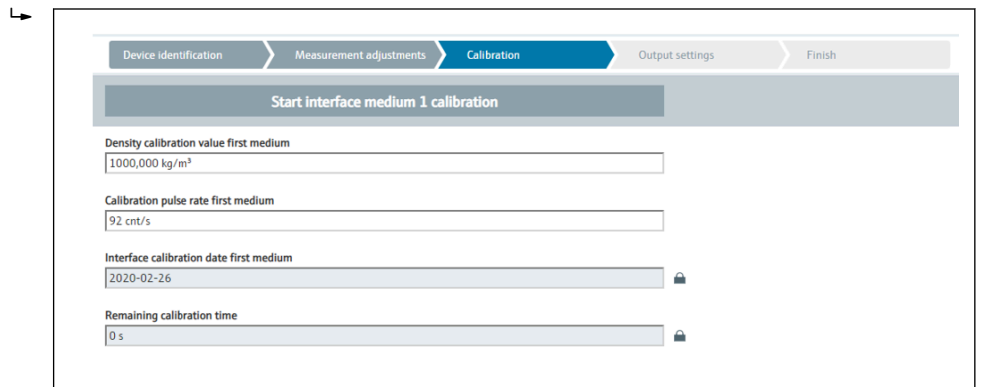

A0042215

The calibration can be performed by pressing the "Start interface 1st/2nd medium calibration" button. The measurement then starts automatically and continues, at the very maximum, for as long as has been configured for the calibration time. However, the process can also be stopped manually by pressing the "Stop calibration" button.

The calibration stops automatically as soon as a million pulses have been totalized.

Alternatively, the pulse rate can also be entered directly.

For the "Next" button in the Wizard to be enabled, the value must, however, be changed from the start value, at least temporarily.

2. With this calibration point, the density of the medium is entered in the "Density calibration value of 1st/2nd medium" field.

↳ This establishes the reference between the determined pulse rate and the density of the medium.

The "Calibration date of 1st/2nd medium interface" field provides the user with information on the time the calibration value was recorded.

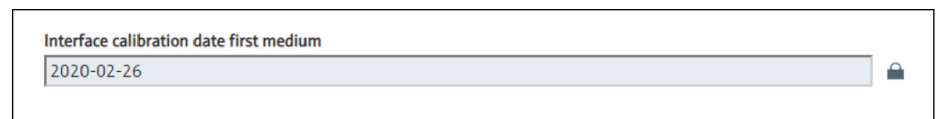

A0042216

The following message is displayed following a successful calibration:

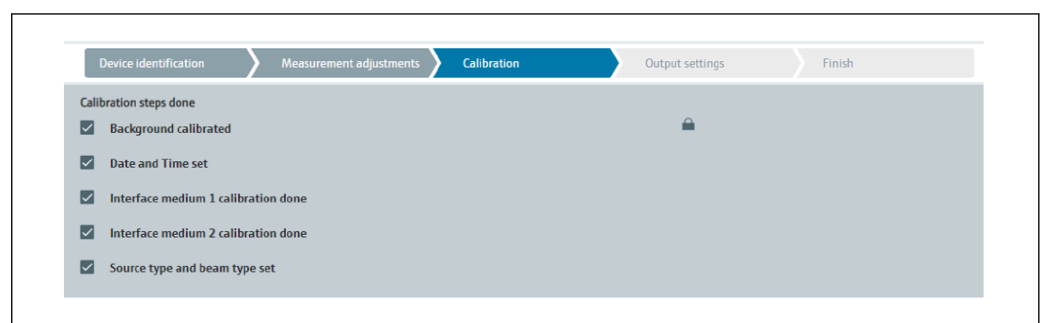

A0042217

The settings for the current output are then made in the "Output settings" step

### Concentration

In concentration measurements, linearization defines the correlation between the measured density and the concentration.

The concentration measurement is therefore a density measurement with subsequent linearization. The calibration process is identical to density measurement.

Linearization is performed on completion of the density calibration.

**Example:** take the necessary value pairs from the diagram.

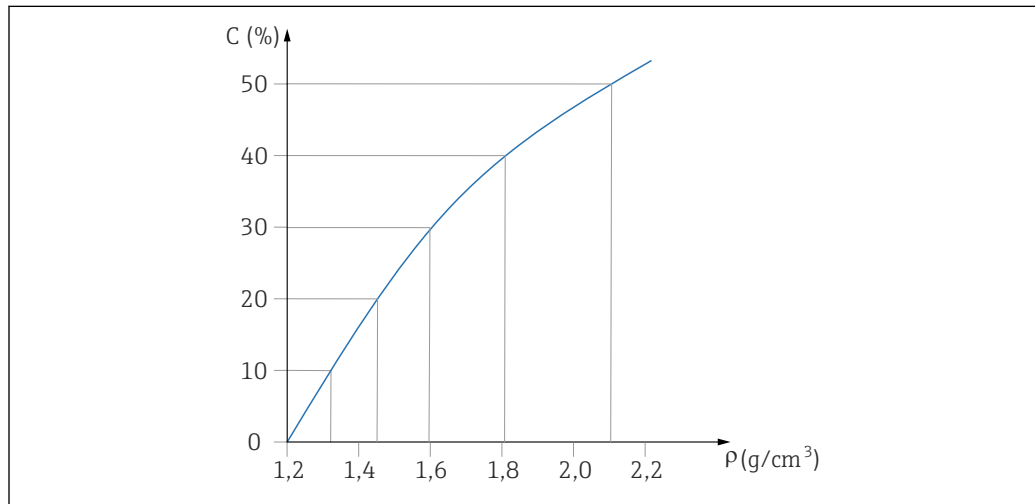

A0042218

19 Example of a linearization curve for concentration measurements

### Linearization

Linearization table conditions

- The table can consist of up to 32 "density value : concentration (%)" pairs
- The table must decrease monotonically
  - The first value in the table must correspond to the minimum density value
  - The last value in the table must correspond to the maximum density value

1. Perform density calibration

2. Perform linearization

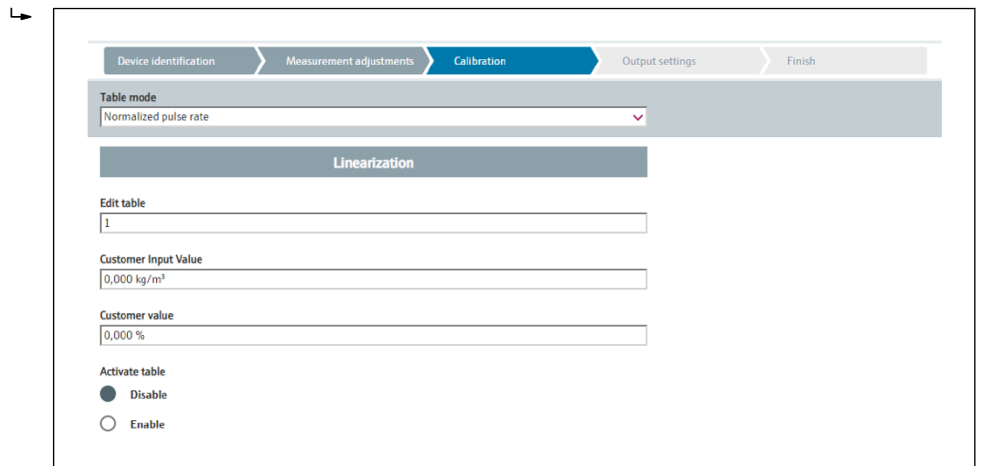

A0042219

The individual linearization values are entered via the input screen or via a separate linearization module.  
 The linearization table consists of up to 32 "density value : concentration (%)" value pairs.

3. The table values can be sorted as monotonically decreasing using the "Table mode -> Sort table" function.

↳ **Edit table:** the index of the linearization point is entered in this field (1-32 points)

**Customer input value:** enter the customer density

**Customer value:** level in unit of length, volume unit or %.

**Activate table:** the "Enable" option must first be selected before the linearization table is used. The linearization table is not used as long as "Disable" is selected.

4. The linearization table can also be entered manually in the linearization module. This is started by selecting the "Linearization" button:

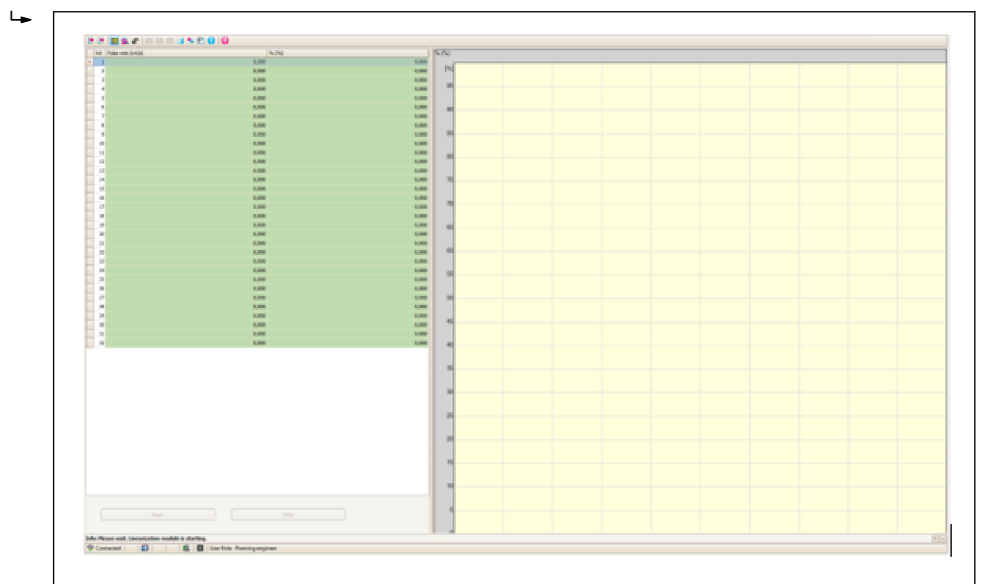

A0042219

The normalized pulse rate and the customer value can be entered directly in table form in this module.

The linearization table must be activated by selecting "Activate table" = Enable

**TIP:** if the density adjustment is already completed in the Wizard, it is no longer displayed. The operating mode must be temporarily set to "Density" in the Wizard to be able to perform the density adjustment again or to recalibrate.

5. The calibration has been performed successfully.

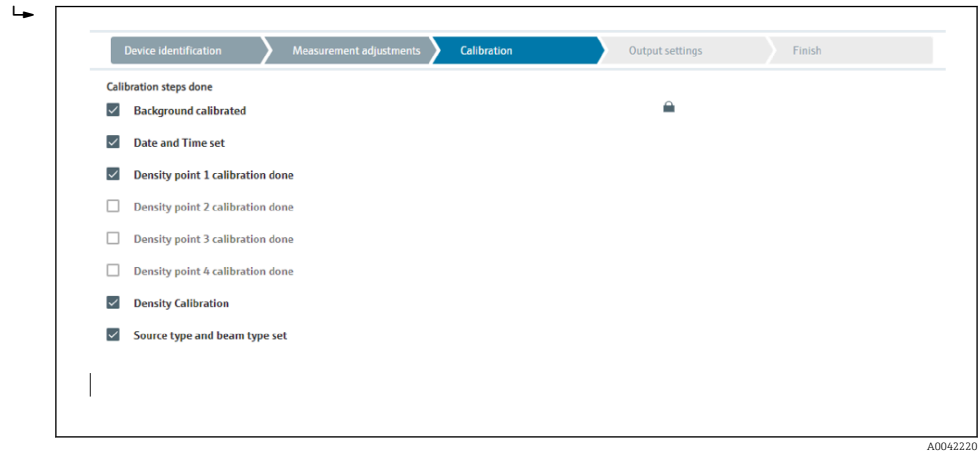

A0042220

6. The settings for the current output are then made in the "Output settings" step

### Concentration of radiating media

For concentration measurement in radiating media (e.g.: K40), the GammapiLOT FMG50 requires at least two other calibration points in addition to the background calibration:

- Pulse rate at high concentration of radiating medium
- Pulse rate at low concentration of radiating medium

The linearization defines the correlation between the measured pulse rate and the concentration of the radiating medium (0 to 100%).

The GammapiLOT FMG50 makes a variety of linearization modes available:

- Linear assignment of the pulse rate to the concentration
- Entry of any linearization table adapted to the specific application.
  - The linearization table consists of up to 32 "normalized pulse rate : concentration" value pairs
  - The linearization table must be monotonic increasing, i.e. a higher concentration must always be paired with a higher pulse rate.

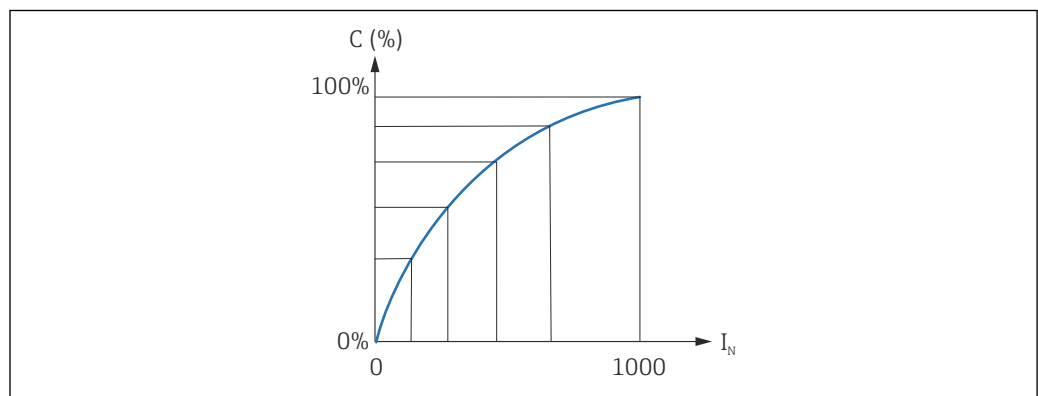

A0042221

20 Example of a linearization curve for measurements of the concentration of radiating media

$C$  Concentration of radiating media

$I_N$  Normalized pulse rate

1. Selection of the type of linearization (already selected in the "Measurement settings" section)

2. **Selection:** start with a high concentration of the radiating medium or start with a low concentration of the radiating medium
  - ↳ Start calibration -> the calibration can be stopped once the pulse rate has stabilized.

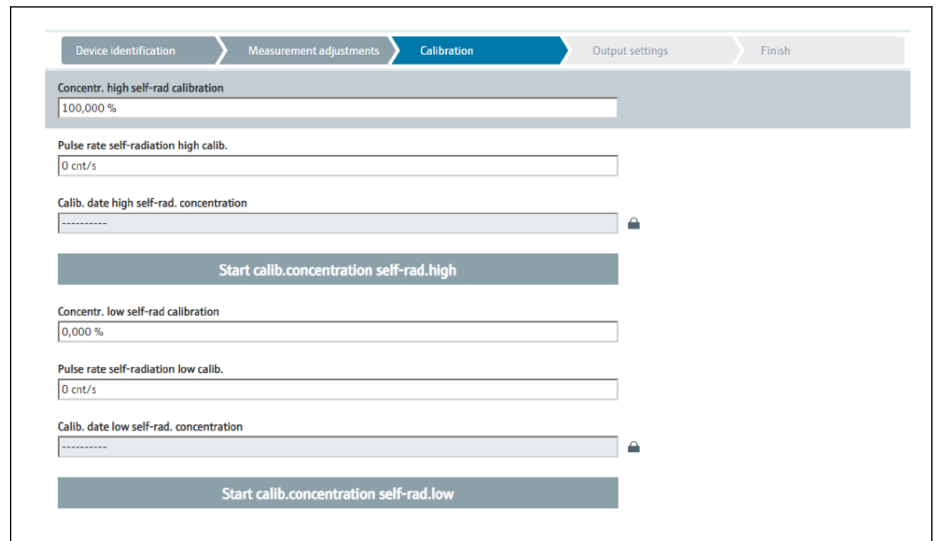

A0042222

3. Calibration with high concentration
  - ↳ Press the "Calibration conc. self-rad. high" button
4. Calibration with low concentration
  - ↳ Press the "Calibration conc. self-rad. low" button
5. The measurement then starts automatically and continues, at the very maximum, for as long as has been configured for the calibration time.
  - ↳ However, the process can also be stopped manually by pressing the "Stop calibration" button.  
The calibration stops automatically as soon as a million pulses have been totalized.
6. Entry for each calibration point: enter the concentration of the medium in the "Calibration conc. self-rad. high" and "Calibration conc. self-rad. low" field
  - ↳ This establishes the reference between the determined pulse rate and the concentration of the radiating medium.  
**TIP:** take a sample of the medium during the integration and then determine the concentration (e.g. in the laboratory)
7. If a customized table has been selected for the linearization, the following input screen appears:

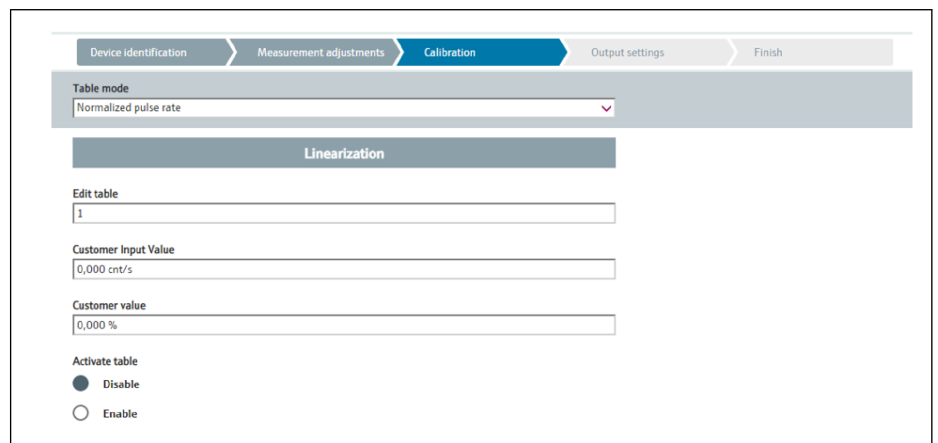

A0042223

The procedure varies depending on the type of table that is selected.

- For the "Normalized pulse rate" type of table
- For the "Semi-automatic" type of table

*Normalized pulse rate*

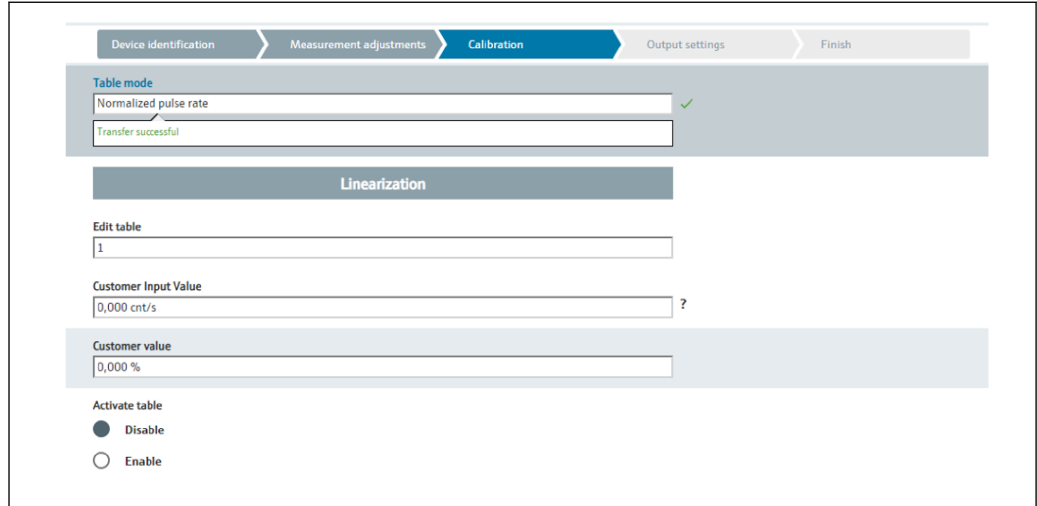

A0042183

N	C	I	I <sub>N</sub>
1	100	2431	1000
2	92	1935	792
3	83	1283	519
4	65	642	250
5	35	231	77
6	0	46	0

*Normalized pulse rate*

Note that the normalized pulse rate is entered in the linearization table. The normalized pulse rate is not identical to the pulse rate actually measured. The correlation between these two variables is defined by:

$$I_N = (I - I_0) / (I_{MAX} - I_0) \times 1000$$

Where:

- I<sub>0</sub> is the minimum pulse rate (i.e. the pulse rate for full calibration)
- I<sub>MAX</sub> is the maximum pulse rate (i.e. the pulse rate for empty calibration)
- I: the measured pulse rate
- I<sub>N</sub>: the normalized pulse rate

The normalized pulse rate is used because it does not depend on the activity of the radiation source used:

- For L = 0 % (empty vessel), I<sub>N</sub> always = 1000
- For L = 100 % (full vessel) I<sub>N</sub> always = 0

The individual linearization values can be entered via the input screen or via a separate linearization module. The linearization table consists of up to 32 "normalized pulse rate : concentration" value pairs.

#### Linearization table conditions

- The table can consist of up to 32 "concentration - linearized value" pairs.
- The table must decrease monotonically
  - The first value in the table must correspond to the minimum concentration
  - The last value in the table must correspond to the maximum concentration

The table values can be sorted as monotonically increasing using the "Table mode -> Sort table" function.

**Edit table:** the index of the linearization point is entered in this field (1-32 points)

**Customer input value:** enter the normalized pulse rate

**Customer value:** concentration in %.

**Activate table:** the "Enable" option must first be selected before the linearization table is used. The linearization table is not used as long as "Disable" is selected.

The linearization table can also be entered manually in the linearization module. This is started by selecting the "Linearization" button:

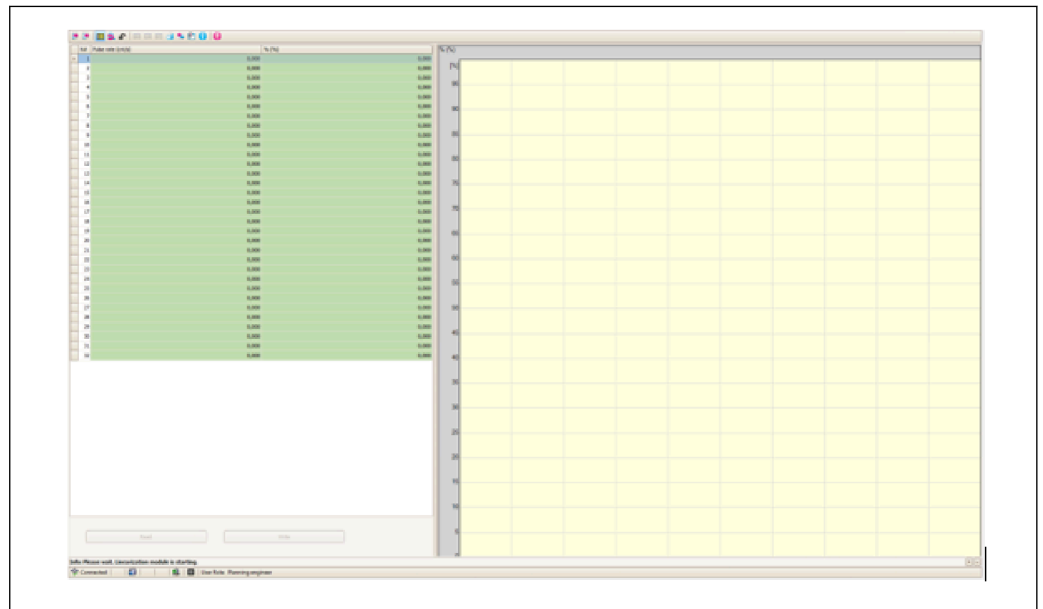

A0042194

The normalized pulse rate and the customer value can be entered directly in table form in this module.

 The linearization table must be activated by selecting "Activate table" -> "Enable"

*Semi-automatic*

During semi-automatic linearization, the device measures the concentration for every table point. The associated linearized value is entered manually. The individual linearization values are entered via the input screen. The linearization table consists of up to 32 "measured pulse rate : concentration" value pairs.

## Linearization table conditions

- The table can consist of up to 32 "concentration - linearized value" pairs.
- The table must increase monotonically
  - The first value in the table must correspond to the minimum concentration
  - The last value in the table must correspond to the maximum concentration

The table values can be sorted as monotonically increasing using the "Table mode -> Sort table" function.

**Edit table:** the index of the linearization point is entered in this field (1-32 points)

**Customer input value:** measured pulse rate for the linearization point

**Customer value:** concentration in %.

**Activate table:** the "Enable" option must first be selected before the linearization table is used. The linearization table is not used as long as "Disable" is selected.

To record a new input value, press the "Start semi-automatic calibration" button. The measurement then starts automatically and continues, at the very maximum, for as long as has been configured for the calibration time. However, the process can also be stopped manually by pressing the "Stop calibration" button.

The calibration stops automatically as soon as a million pulses have been totalized.



The remaining calibration time of the semi-automatic calibration is not displayed on the user interface.



The linearization table must be activated by selecting "Activate table" -> "Enable"

### Use of the linearization module with linearization values recorded semi-automatically



Please note the following if using the linearization module with linearization tables recorded semi-automatically:

- i** The module assumes pulse rates are normalized and automatically switches the internal measurement calculation to normalized values if the module is used. This falsifies the assignment between the output value and the measured value. If the linearization module has been opened with semi-automatic linearization curves, the table mode must be set to "semi-automatic" again.
- i** Note: the linearization can calculate an incorrect value if the wrong table mode is used. The current output will also output an incorrect measured value in this case.

The following message is displayed following a successful calibration:

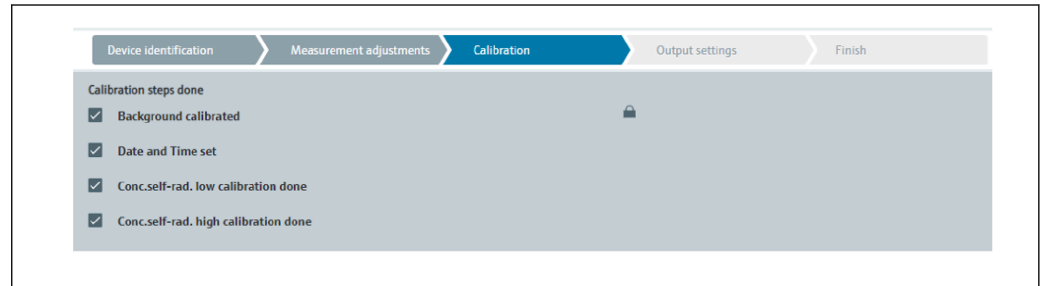

A0042225

The settings for the current output are made after the calibration of the operating mode in the "Output settings" step

**Settings of the current output**

1. Set the lower limit value (4 mA) and the upper limit value (20 mA) of the current output to the desired values of the primary measured value

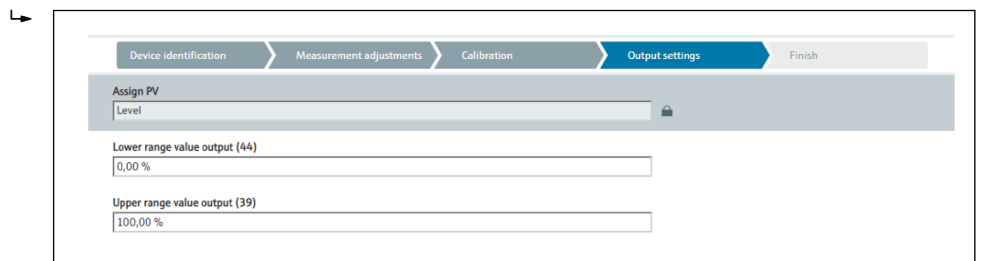

A0042226

These values can be used for a zoom function or to invert the measured value to the current value.

2. The control range of the current output can be modified

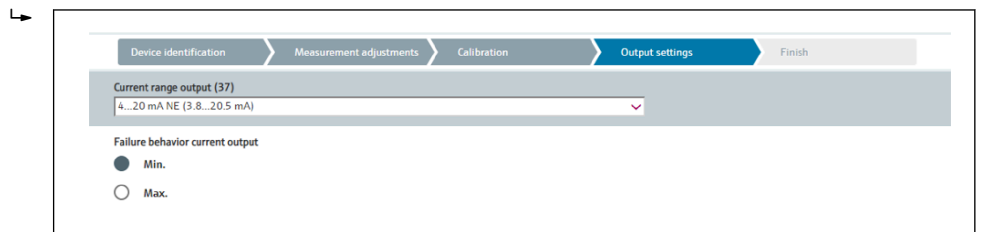

A0042227

The measuring range of the current output can be defined as:

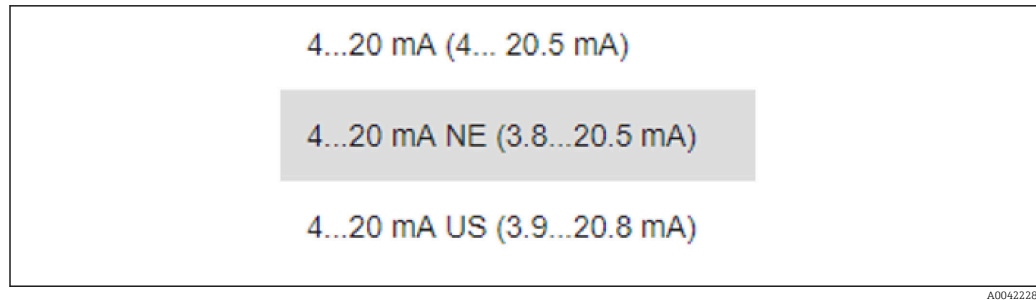

The failure current behavior can be defined as a min or max alarm.

- Min alarm is defined with  $<3.6$  mA
- Max alarm is defined with  $>21.5$  mA
- i
  - Both alarm conditions are guaranteed over the entire temperature range and under the influence of EMC interferences
  - If max alarm current has been selected as the failure current, the current value can be adjusted between 21.5 to 23 V  
The setting is made via the operating menu:  
**Application -> Current output -> Failure current**
  - In the case of the min alarm settings, there may not be sufficient energy to power the display lighting and the Bluetooth function. To guarantee the measurement function, the display lighting/Bluetooth functions may be disabled and enabled again once sufficient power is available.

**The calibration of the Gammapilot FMG50 is completed.**

### 7.2.5 Slave mode

The slave mode can be used if the measured raw pulse rate is to be processed by a downstream evaluation unit (e.g. a controller) and not by the Gammapilot FMG50.

In this operating mode, the Gammapilot FMG50 transmits the raw pulse rate in cnt/125 ms as the primary value.

No other settings must be made once the "Slave mode" has been selected. Commissioning is concluded immediately.

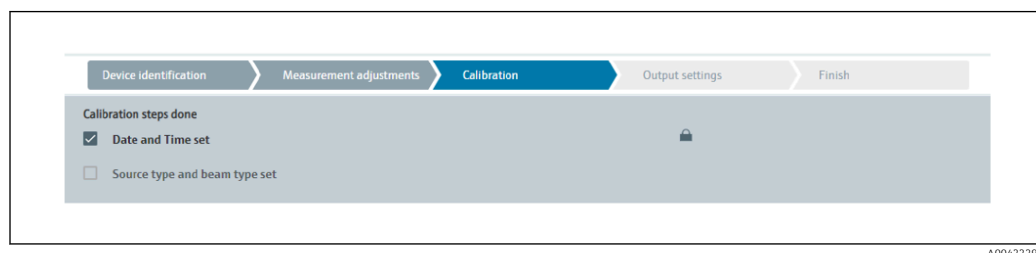

i The current output is automatically assigned linearly:

- 4 mA = 0 cnt/125 ms
- 20 mA = 1000 cnt/125 ms

i The use of a gamma modulator FHG65 cannot be configured in the "Slave" operating mode.

If the use of a gamma modulator FHG65 is required, please contact Endress+Hauser Service.

## 7.3 Commissioning via SmartBlue app

### 7.3.1 Requirements

#### Device requirements

Commissioning via SmartBlue is only possible if the device has a Bluetooth module.

#### SmartBlue system requirements

SmartBlue is available as a download from the Google Play Store for Android devices and from the iTunes Store for iOS devices.

- Devices with iOS:  
iPhone 4S or higher from iOS9.0; iPad2 or higher from iOS9.0; iPod Touch 5th generation or higher from iOS9.0
- Devices with Android:  
From Android 4.4 KitKat and *Bluetooth*® 4.0

#### Initial password

The serial number of the device is used as the initial password when establishing the connection for the first time. The serial number can be found on the nameplate.

### 7.3.2 SmartBlue app

1. Scan the QR code or enter "SmartBlue" in the search field of the App Store.

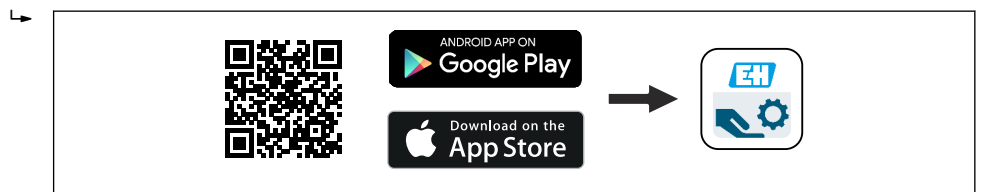

21 Download link

2. Start SmartBlue.
3. Select device from livelist displayed.
4. Enter the login data:
  - ↳ User name: admin
  - Password: serial number of the device or ID number of the Bluetooth display
5. Tap the icons for more information.

For commissioning, see the "Commissioning Wizard" section

Change the password after logging in for the first time!

Bluetooth is not available in all markets.

Please pay attention to the radio approvals listed in document SD02402F or contact the Endress+Hauser sales organization.

## 7.4 Commissioning via on-site operation

The device can also be operated on site using the keys. If operation is locked using the DIP switches on site, parameter entry via communication is not possible.

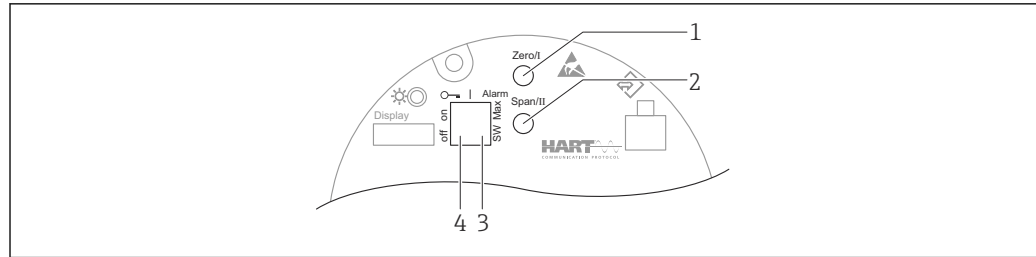

- 1 Operating key for empty calibration (function I)
- 2 Operating key for full calibration (function II)
- 3 DIP switch for alarm current (SW-defined / Min alarm)
- 4 DIP switch for locking and unlocking the measuring device

- **Empty calibration:** press and hold the operating key for empty calibration (I) > 3 s
- **Full calibration:** press and hold the operating key for full calibration (II) > 3 s
- **Background calibration:** simultaneously press and hold the operating key for empty calibration (I) and the operating key for full calibration (II) > 3 s
- **Reset to factory defaults:** simultaneously press and hold the operating key for empty calibration (I) and full calibration (II) > 12 s. The LED starts flashing. When the flashing stops, the device is reset to the factory default settings.

#### 7.4.1 Level basic calibration

Calibration time per calibration: **5 min!**

1. Reset
  - ↳ Press both keys > 12 s
2. Start background calibration
  - ↳ Press both keys > 3 s
  - The green LED is lit for one second and starts flashing at an interval of 2 s
3. Start empty calibration
  - ↳ Press the "Zero / 1" key > 3 s
  - The green LED is lit for one second and starts flashing at an interval of 2 s
  - Wait 5 min until the green LED stops flashing
4. Start full calibration
  - ↳ Press the "Span / 2" key > 3 s
  - The green LED is lit for one second and starts flashing at an interval of 2 s
  - Wait 5 min until the green LED stops flashing

**i** A reset deletes all calibrations!

#### 7.4.2 Status and power LED

A green LED that signals the status and button activation feedback is provided on the electronic insert.

Behavior of the LED

- The LED flashes once briefly when the measuring device is started
- When a key is pressed, the LED flashes to confirm the key activation
- When a reset is performed, the LED flashes as long as both keys are pressed and the reset is not yet active (countdown). The LED stops flashing once the reset is active.
- The LED flashes while calibration is being performed via onsite operation

## 7.5 Commissioning of density compensation with RSG45 (gamma computer)

Level measurement: FMG50 with Memograph M RSG45 and gas density information.

In the vessel containing the medium to be measured, the gas phase is above the medium. The gas phase also absorbs gamma radiation in the process, albeit to a much lesser degree than the medium. This absorption is factored into the calculations and offset during the calibration.

A compensation of the level measurement is recommended, however, in processes with a fluctuating gas density. Here, the level signal is calculated with the variable gas density value and compensated for.

### 7.5.1 Scenario 1: density compensation via temperature and pressure measurement

The gas density is calculated depending on the pressure and temperature

#### Measuring system arrangement

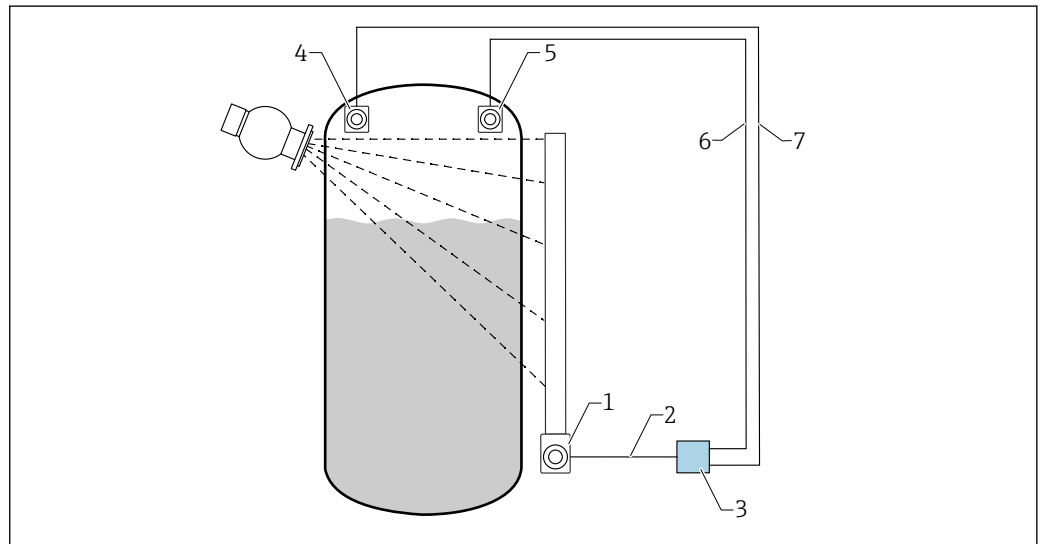

22 Connection example: RSG45 (scenario 1)

- 1 FMG50 (level)
- 2 HART channel 2 (level)
- 3 RSG45
- 4 Pressure sensor
- 5 Temperature sensor
- 6 HART channel 4 (temperature)
- 7 HART channel 3 (absolute pressure)

#### Connection of HART channels of the RSG45

**Channel 2:** FMG50 level measurement

**Channel 3:** absolute pressure measurement

**Channel 4:** temperature measurement

## Configuring RSG45

### Setting or deleting the limit values

1. Navigate to limit values: "Setup -> Extended setup -> Application -> Limit values"

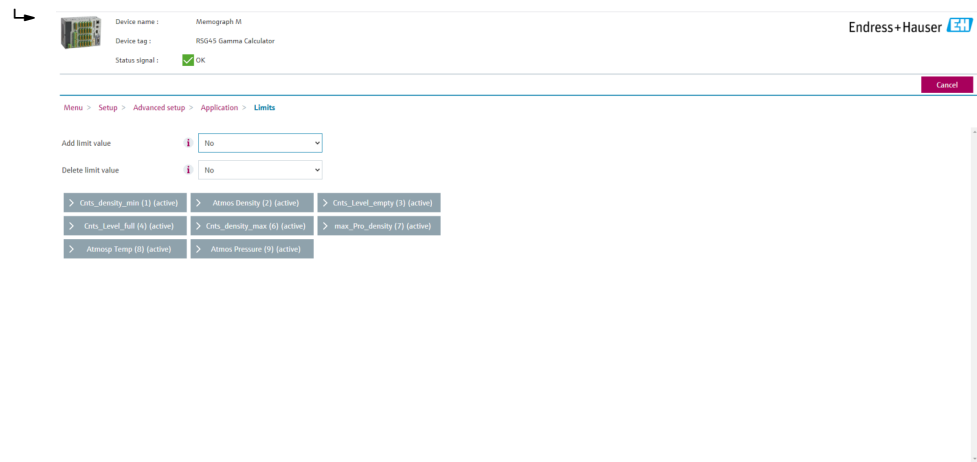

2. Enter the limit values

- FMG50 (density measurement), channel 1
  - **Cnts\_density\_min**: Pulse rate (pulses per second, cnt/s) of the FMG50 (density) at atmospheric conditions (environment)
  - **Atmos Density**: atmospheric density (environment)
  - **Cnts\_density\_max**: pulse rate (pulses per second, cnt/s) of the FMG50 (density) at maximum process density
  - **max\_Pro\_density**: maximum process density
- FMG50 (level measurement), channel 2
  - **Cnts\_Level\_empty**: pulse rate (pulses per second, cnt/s) at 0 % level
  - **Cnts\_Level\_full**: pulse rate (pulses per second, cnt/s) at 100 % level
- Pressure measurement, channel 3
  - **Atmos Pressure**: atmospheric pressure (reference)
- Temperature measurement, channel 4
  - **Atmos Temp**: atmosphere temperature (reference)

### Setting mathematical functions and linearization table

#### Display as percentage

1. In the Expert menu, navigate to the linearization table: Expert → Application → Mathematics → Level → Linearization

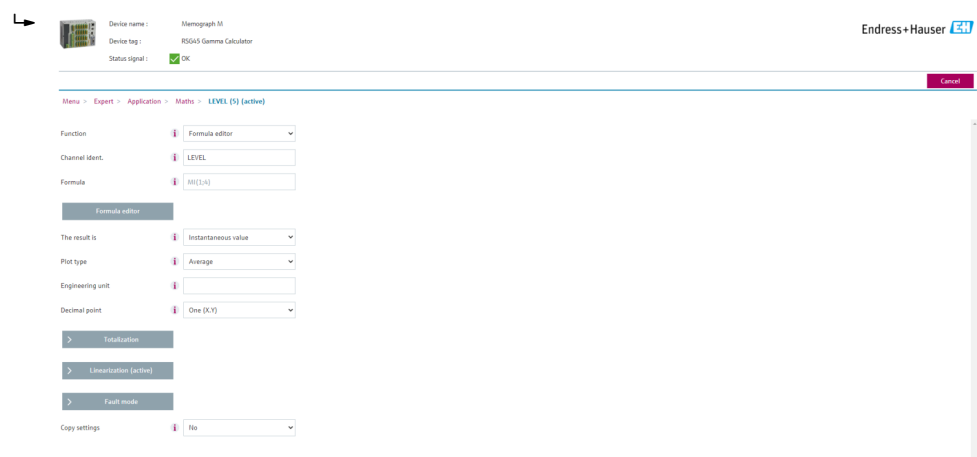

2. Enter value pairs in the linearization table. A value pair consists of a percentage value and the associated pulse rate (pulses per second, cnt/s).
    - ↳ The linearized measured value is shown as a percentage.
- i** The linearization table consists of up to 32 value pairs.  
Enter as many value pairs as possible to maximize accuracy.

### Setting sensors and channels

#### Channel 2:

FMG50 level measurement (HART output)

- PV: level (%)
- SV: pulse rate (pulses per second, cnt/s)

#### Channel 3:

Pressure measurement (HART output)

PV: absolute pressure (bar)

#### Channel 4:

Temperature measurement (HART output)

PV: temperature (K)

## 7.5.2 Scenario 2: density compensation via FMG50 gas density measurement

### Measuring system arrangement

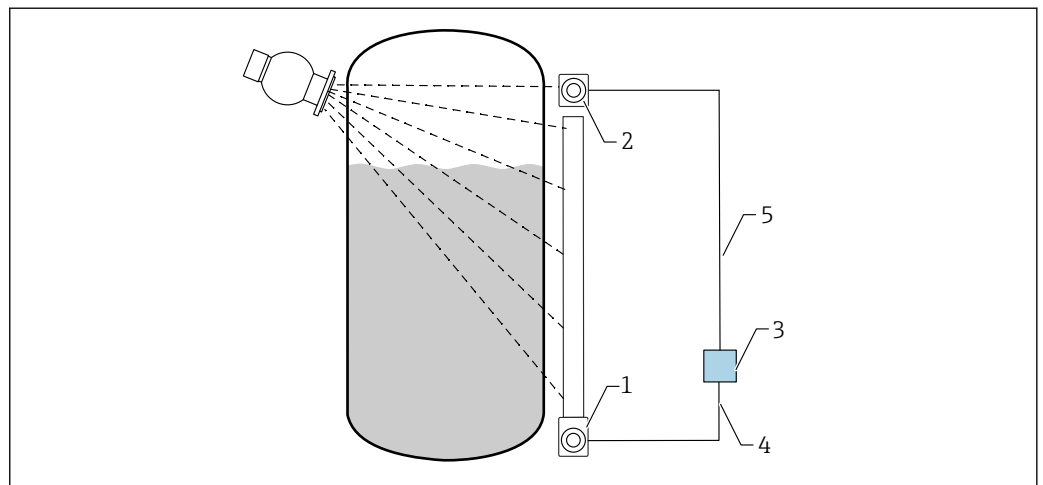

**23** Connection example: RSG45 (scenario 2)

- 1 FMG50 (level)
- 2 FMG50 (density)
- 3 RSG45
- 4 HART channel 2 (level)
- 5 HART channel 1 (density)

### Connection of HART channels of the RSG45

**Channel 1:** FMG50 density measurement

**Channel 2:** FMG50 level measurement

## Configuring RSG45

### Setting or deleting the limit values

1. Navigate to limit values: "Setup -> Extended setup -> Application -> Limit values"

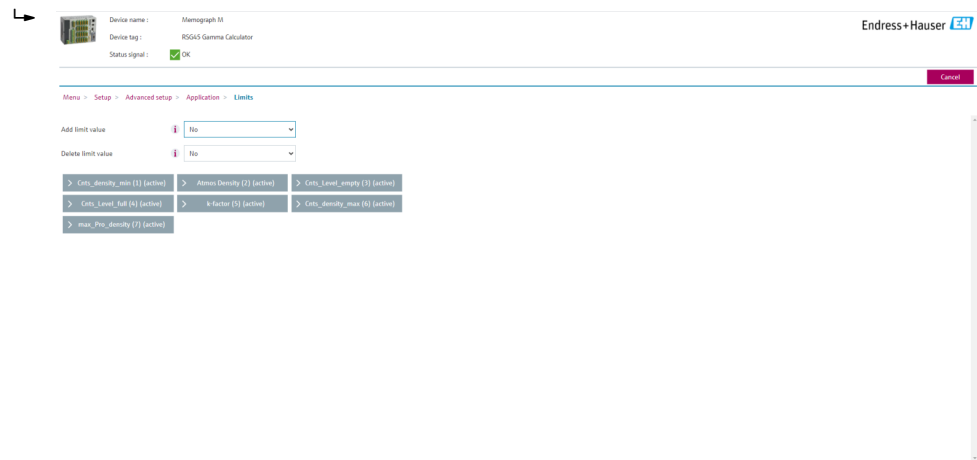

2. Enter the limit values

- FMG50 (density measurement), channel 1
  - **Cnts\_density\_min**: pulse rate (pulses per second, cnt/s) of the FMG50 (density) at atmospheric conditions (environment)
  - **Atmos Density**: atmospheric density (environment)
  - **Cnts\_density\_max**: pulse rate (pulses per second, cnt/s) of the FMG50 (density) at maximum process density
  - **max\_Pro\_density**: maximum process density
  - **K-factor** =  $\ln(\text{pulse rate}_{\text{vapor}} / \text{pulse rate}_{\text{atm}}) / (\rho_{\text{vapor}} - \rho_{\text{atm}})$
- FMG50 (level measurement), channel 2
  - **Cnts\_Level\_empty**: pulse rate (pulses per second, cnt/s) at 0 % level
  - **Cnts\_Level\_full**: pulse rate (pulses per second, cnt/s) at 100 % level

 Calculate the K-factor during commissioning and enter into the RSG45.

### Setting mathematical functions and linearization table

#### Display as percentage

1. In the Expert menu, navigate to the linearization table: Expert -> Application -> Mathematics -> Level -> Linearization

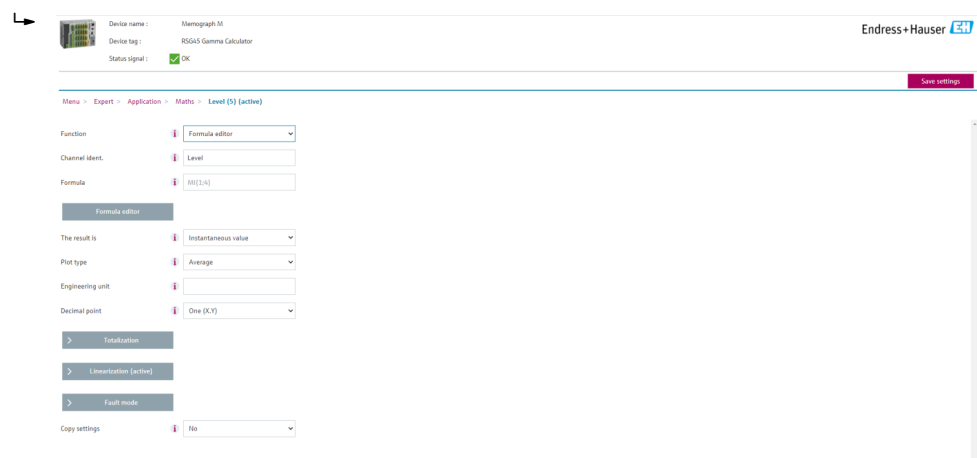



2. Enter value pairs in the linearization table. A value pair consists of a percentage value and the associated pulse rate (pulses per second, cnt/s).
  - ↳ The linearized measured value is shown as a percentage.

 The linearization table consists of up to 32 value pairs.  
Enter as many value pairs as possible to maximize accuracy.

### Setting sensors and channels

#### Channel 1:

FMG50 density measurement (HART output)

- PV: density (kg/m<sup>3</sup>)
- SV: pulse rate (pulses per second, cnt/s)

#### Channel 2:

FMG50 level measurement (HART output)

- PV: level (%)
- SV: pulse rate (pulses per second, cnt/s)

## 7.6 Operation and settings via RIA15



See the RIA15 Operating Instructions, BA01170K

## 7.7 Data access - Security

### 7.7.1 Locking via password in FieldCare / DeviceCare / SmartBlue

The Gammapilot FMG50 can be locked and unlocked via a password (see the "Software locking" section)

### 7.7.2 Hardware locking

The Gammapilot FMG50 can be locked and unlocked via a switch on the main unit. Hardware locking can only be unlocked via the main unit (flip the switch). It is not possible to unlock the hardware by communication.

### 7.7.3 Bluetooth® wireless technology (optional)

**Signal transmission via Bluetooth® wireless technology uses a cryptographic technique tested by the Fraunhofer Institute**

- The device is not visible via *Bluetooth*® wireless technology without the SmartBlue App.
- Only one point-to-point connection between **one** sensor and **one** smartphone or tablet is established.
- The *Bluetooth*® wireless technology interface can be deactivated via SmartBlue, FieldCare or DeviceCare.
- The *Bluetooth*® wireless technology interface can be reactivated via FieldCare or DeviceCare.
- It is not possible to reactivate the *Bluetooth*® wireless technology interface via the SmartBlue App.

### 7.7.4 RIA15 locking

The device setup can be locked with a 4-digit user code



Additional information is available in the Operating Instructions for the RIA15

## 7.8 Overview of the operating menu

A complete overview of the operating menu is provided in the "Description of Device Parameters" documentation.



GP01141F

## 8 Diagnostics and troubleshooting

### 8.1 System error messages

#### 8.1.1 Error signal

Errors occurring during commissioning or operation are signaled in the following way:

- Error symbol, display color, error code and error description on the display and operating module.
- Current output, customizable:
  - MAX, 110%, 22 mA
  - MIN, -10%, 3.6 mA

 Standard setting: MIN, -10%, 3.6 mA

 The max. alarm current can be configured in the 21.5 to 23.0 mA range. The default value is 22.5 mA.

#### 8.1.2 Types of error

- Error-free operation: display is lit green
- Alarm or warning: display is lit red
- Alarm: the output current adopts a value that has been defined beforehand. An error message is displayed
  - MAX, 110%, 22 mA
  - MIN, -10%, 3.8 mA
- Warning: the device continues to measure. An error message is displayed (alternating with the measured value)

 Error indication via a display color change only works if the operating voltage is not below 16 V

### 8.2 Possible calibration errors

Fault	Possible causes	Solution	
Pulse rate too low with empty vessel	Radiation source switched off	Switch on source at the source container	
	Incorrect alignment of source housing	Realign angle of emission	
	Buildup in the vessel	Clean vessel or Recalibrate (if buildup is stable)	
	Fittings in the vessel have not been considered in the activity calculation	Recalculate activity and change radiation source if required	
	Pressure in the vessel has not been considered in the activity calculation	Recalculate activity and change radiation source if required	
	No radiation source in the source container	Load radiation source	
	Radiation source too weak	Use source with higher activity	
	If a modulator is used	Modulator is not mounted correctly	
		Modulator is not in operation	
		Radiation is not set to modulated	
If a collimator is used	Incorrect alignment of radiation entry window		

Fault	Possible causes	Solution
Pulse rate too high with empty vessel	Activity too high	Attenuate radiation, e.g. by mounting a steel plate in front of the source container; or replace radiation source
	External radiation sources present (e.g. from gammagraphy)	Shield off if possible; repeat calibration without external radiation source
Pulse rate too high with full vessel	External radiation sources present (e.g. from gammagraphy)	Shield off if possible; repeat calibration without external radiation source

## 8.3 Diagnostic event

### 8.3.1 Diagnostic event in the operating tool

If a diagnostic event is present in the device, the status signal appears in the top left status area of the operating tool along with the corresponding symbol for the event level in accordance with NAMUR NE 107:

- Failure (F)
- Function check (C)
- Out of specification (S)
- Maintenance required (M)
- Error-free operation: display is lit green
- Alarm or warning: display is lit red

#### Calling up remedial measures

- ▶ Navigate to the **Diagnostics** menu
  - ↳ In the **Actual diagnostics** parameter the diagnostic event is shown with event text

### 8.3.2 List of diagnostic events in the operating tool

Diagnostic number	Short text	Remedy instructions	Status signal [from the factory]	Diagnostic behavior [from the factory]
<b>Diagnostic of sensor</b>				
007	Sensor defective	Replace sensor electronics	F	Alarm
008	Sensor defective	1. Restart device 2. Contact service	F	Alarm
062	Sensor connection faulty	Check sensor connection	F	Alarm
064	Pulse rate out of range	1. Check process conditions 2. Check environmental conditions 3. Replace device	C	Warning
082	Data storage inconsistent	1. Check Data Unit 2. Contact service	F	Alarm
<b>Diagnostic of electronic</b>				
242	Firmware incompatible	1. Check software 2. Flash or change main electronic module	F	Alarm
252	Module incompatible	1. Check if correct electronic modul is plugged 2. Replace electronic module	F	Alarm

Diagnostic number	Short text	Remedy instructions	Status signal [from the factory]	Diagnostic behavior [from the factory]
270	Main electronics defective	Replace main electronics	F	Alarm
272	Main electronics faulty	1. Restart device 2. Contact service	F	Alarm
273	Main electronics defective	1. Emergency operation via display 2. Change main electronics	F	Alarm
282	Data storage inconsistent	1. Restart device 2. Contact service	F	Alarm
283	Memory content inconsistent	1. Transfer data or reset device 2. Contact service	F	Alarm
287	Memory content inconsistent	1. Restart device 2. Contact service	M	Warning
311	Electronic failure	Maintenance required! 1. Do not perform reset 2. Contact service	M	Warning
<b>Diagnostic of configuration</b>				
410	Data transfer failed	1. Check connection 2. Retry data transfer	F	Alarm
412	Processing download	Download active, please wait	C	Warning
431	Trim required	Carry out trim	C	Warning
434	Real time clock defective	Replace sensor electronics	C	Alarm
435	Linearization faulty	Check linearization table	F	Alarm
436	Date/time incorrect	Check date and time settings.	M	Alarm
437	Configuration incompatible	1. Restart device 2. Contact service	F	Alarm
438	Dataset different	1. Check data set file 2. Check device configuration 3. Up- and download new configuration	M	Warning
440	Device not calibrated	Calibrate device	F	Alarm
441	Current output out of range	1. Check process 2. Check current output settings	S	Warning
484	Failure mode simulation active	Deactivate simulation	C	Alarm
490	Output simulation	Deactivate simulation	C	Warning
491	Current output 1 simulation active	Deactivate simulation	C	Warning
495	Diagnostic event simulation active	Deactivate simulation	C	Warning
538	Configuration Sensor Unit invalid	1. Check sensor configuration 2. Check device configuration	M	Alarm
544	Background not calibrated	Background not calibrated	C	Warning
586	Calibration active	Recording pulse rate	M	Alarm
593	Simulation pulse rate active	Deactivate simulation	C	Warning
<b>Diagnostic of process</b>				
801	Supply voltage too low	Increase supply voltage	F	Alarm

Diagnostic number	Short text	Remedy instructions	Status signal [from the factory]	Diagnostic behavior [from the factory]
802	Supply voltage too high	Decrease supply voltage	S	Warning
803	Loop current faulty	1. Check wiring 2. Replace electronics	M	Warning
805	Loop current faulty	1. Check wiring 2. Replace electronics	F	Alarm
825	Operating temperature	1. Check ambient temperature 2. Check process temperature	S	Warning
826	Sensor temperature out of range	1. Check ambient temperature 2. Check process temperature	S	Warning
927	Overexposure detected	Please check source	C	Alarm
955	Gammagraphy detected	Gammagraphy detected	C	Warning <sup>1)</sup>
956	Evaluation plateau curve	Evaluation plateau curve	M	Warning

1) Diagnostic behavior can be changed.

#### **Diagnostic number C064:**

Contact the Endress+Hauser Service department before replacing the device

#### **Diagnostic number F825:**

The diagnostic behavior can either be alarm or warning depending on the sensor version

- In the case of NaI (Tl) scintillators, the diagnostic behavior is always warning:
  - if +80 °C is exceeded
  - if -40 °C is undershot
- In the case of PVT scintillators, the diagnostic behavior is:
  - **Alarm:** if +65 °C is exceeded
  - **Warning:** if +60 °C is exceeded or -40 °C is undershot
- In the case of PVT (HT) scintillators, the diagnostic behavior is:
  - **Alarm:** if -25 °C is undershot
  - **Warning:** if +80 °C is exceeded or -20 °C is undershot

#### **Diagnostic number 955:**

Diagnostic behavior can be changed. See Section 8.6 "Gammagraphy"

### 8.3.3 Displaying the diagnostic events

#### **Actual diagnostics**

The **Actual diagnostics** parameter is available in the menu with a time stamp.

#### **Previous diagnostics**

The **Previous diagnostics** parameter is available in the menu with a time stamp.

#### **Event logbook**

The events are saved in the event logbook.





#### **Navigation**

"Diagnostics" menu → Event logbook

## 8.4 Diagnostic event in RIA15

A diagnostic event is not directly shown on the RIA15. The fault F911 only appears directly on the RIA15 display in the event of an alarm.

### Displaying a diagnostic event on the RIA15

1. Navigate to: DIAG/TERR
2. Press 
3. Press 
4. Press 
5. Press  3 times
6. Press 

↳ The diagnostic event of the field device is shown on the RIA15 display  
Type of diagnostic event (F, M, C, S) + code of service ID is shown, e.g. F124 - for F270 (main electronics defective) and service ID 124 (Rom Defect On MB)

## 8.5 Gammagraphy

### 8.5.1 General principles

This function involves the detection of interference radiation that interrupts the measurement. The aim of gammagraphy detection is to detect interference radiation that typically occurs during nondestructive material testing within the system. Without gammagraphy detection, this interference radiation would result in a low measured value (0% or  $\rho_{min}$ ). In contrast, when gammagraphy detection is used, the measured value adopts a defined value in this case (alarm current or hold last measured value).

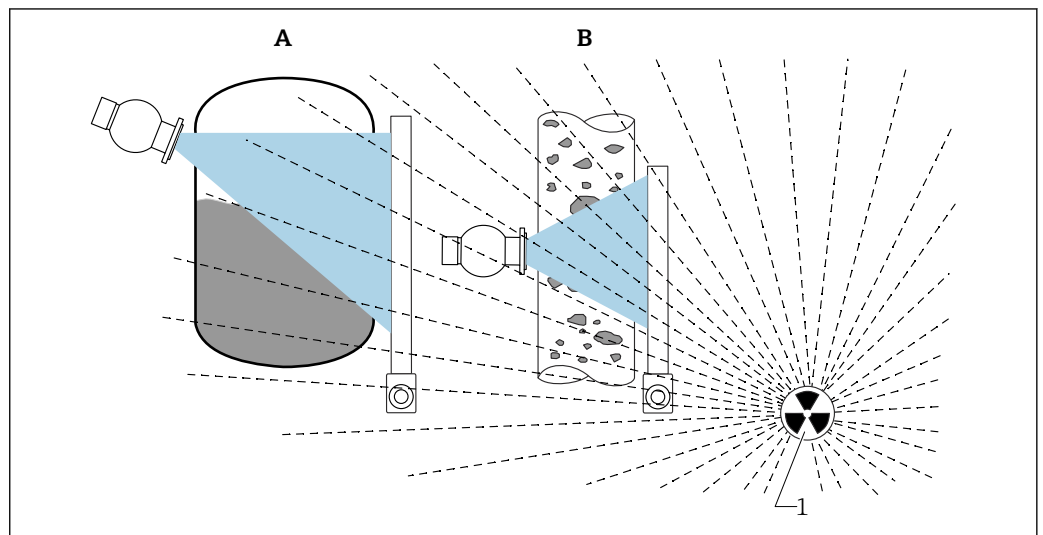

 24 Influence of gammagraphy on radiometric measurements

1 Interference radiation

### 8.5.2 Reaction to detected gammagraphy radiation

If the gammagraphy criterion "gammagraphy limit" is met, the device output adopts a value defined by the user (Gammagraphy detection parameter). Furthermore, a warning is also signaled. After a maximum time defined by the user (Hold time parameter), an alarm

current is output and an event is displayed (can be selected via the Gammagraphy detection parameter).

**i** Gammagraphy detection is also available with modulated radiation.

**i** If the Heartbeat option is available, the number of detected gammagraphy events and the total duration of the detected gammagraphy events are available in the Heartbeat Verification Report.

### 8.5.3 Gammagraphy detection limits and behavior in event of excess radiation

Gammagraphy detection is active in the permitted radiation range of the device, i.e. up to  $\leq 65000$  cnt/s. The accuracy of the device can be guaranteed within this range such that the device is ready to measure again immediately once the gammagraphy event no longer applies.

Above the permitted radiation range, an excess radiation alarm is signaled after 1 s (diagnostic number 927), irrespective of the settings for gammagraphy detection. The current output is always set to failure current during the excess radiation alarm.

To protect the photomultiplier tube, the high-voltage supply for the tube is switched off while the excess radiation alarm is active and cyclically switched back on again in order to check the radiation intensity. The pause time during which the tube is switched off is 60 s. Therefore the end of a period of excess radiation can be detected after 60 s at the very earliest. When the excess radiation ends, the supply voltage is readjusted. As a result, in addition to the pause time approximately 30 s are also needed until the sensor signal leaves the alarm state.

**i** By cyclically switching off the high-voltage, excess radiation can be present for arbitrarily long periods of time without this affecting the operating life of the photomultiplier or the device overall.

### 8.5.4 Gammagraphy settings

Gammagraphy detection can be configured under:

Application -> Sensor -> Gammagraphy detection

Setting	Value
Gammagraphy detection	Warning
Gammagraphy detection	Out of specification (S)
Gammagraphy hold time	10 s
Gammagraphy limit	6178,103 cnt/s
Sensitivity of gammagraphy detection	3

### 8.5.5 Gammagraphy detection parameter

Gammagraphy detection can be switched on and off with this parameter.

**i** In addition, the event class can be defined according to NE107



**Gammagraphy detection -> Off**

Gammagraphy detection is switched off. In a gammagraphy event, the current output will display -10 % measured value (3.8 mA).

**Gammagraphy detection -> Alarm**

Gammagraphy detection is switched on. In a gammagraphy event, the current output will adopt the failure current (3.6 mA or  $\geq 21.5$  mA, depending on the configuration of the alarm current).

**Gammagraphy detection -> Warning**

Gammagraphy detection is switched on. The current output is held at the last valid measured value before gammagraphy detection.

**8.5.6 Gammagraphy hold time parameter**

This parameter defines how long the measured value is held if gammagraphy radiation has been detected. After this time, the current output adopts the value defined in the Gammagraphy detection parameter.

The hold time should be slightly longer than the maximum duration of a gammagraphy measurement. An alarm is signaled if the maximum pulse rate is still exceeded after the hold time.



An event is only written to the event list once the hold time has elapsed

**WARNING**

- ▶ A change in the measured value is not detected during the hold time. In a safety protection circuit, the selected hold time may not be greater than the permitted process safety time

**8.5.7 Gammagraphy limit parameter**

Gammagraphy radiation is detected if the pulse rate at the detector exceeds the maximum gammagraphy limit value. This value is determined using the maximum pulse rate from the calibration (generally "upper range value") and the configured gammagraphy sensitivity.

**8.5.8 Gammagraphy sensitivity parameter**

The suitable sensitivity value largely depends on the process and ambient conditions. Therefore no general rules apply for the choice of sensitivity value. However, the following principles can serve as a guide:

- A small value (between 1 and 3) should be entered for homogeneous products with an even, calm surface. Gammagraphy is then detected with a high degree of sensitivity.
- A large value (between 3 and 7) should be entered for non-homogeneous products and turbulent surfaces, as random variations in the pulse rate would otherwise be wrongly detected as a gammagraphy event.



If the device occasionally reports gammagraphy even though no gammagraphy radiation is present, then it is advisable to increase the value slightly. Conversely, the value should be reduced if gammagraphy radiation was not detected.

## 8.6 Density recalibration for multi-point calibration

### 8.6.1 General principles

A recalibration of the measurement can be necessary if the measuring conditions have changed, e.g. in the event of deposit buildup on the pipe.

The absorption coefficient  $\mu$  of the original calibration is maintained but the reference pulse rate  $I_0$  is redetermined, which causes a shift in the overall linearization function.

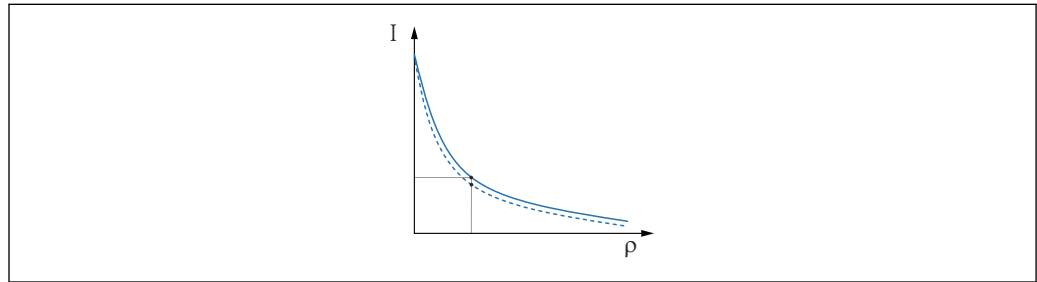

A0042150

25 Linearization shift

$I$  Pulse rate (pulses per second, cnt/s)

$\rho$  Density

### 8.6.2 Performing density recalibration for multi-point calibration

1. In the operating menu, change the type of calibration from **Multipoint calibration** option to **One point calibration** option

↳ Application → Sensor → Density Settings → Calibration or Linearization type

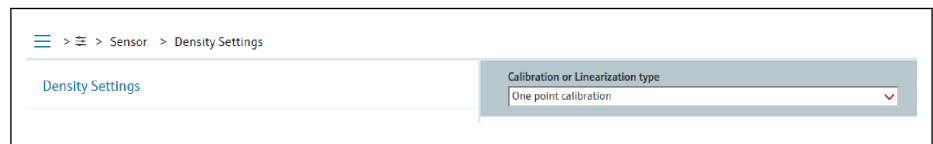

A0042151

2. After changing the type of calibration to one point calibration, perform the one point calibration using the Commissioning Wizard.

**i** **Only change the type of calibration in the operating menu.** If the type of calibration is changed in the Commissioning Wizard, the existing absorption coefficient of the current calibration is replaced by the default value  $7.7 \text{ mm}^2/\text{g}$ . This would require a complete recalibration of the measuring point. In this case, the  $\mu$ -value can be taken manually from the commissioning documentation and entered instead of the default value.

## 8.7 Real-time clock and decay compensation

### 8.7.1 General principles

For decay compensation, the Gammapiot FMG50 contains a real-time clock, which is generally powered by the terminal voltage. This clock is backed up by a battery to bridge voltage interruptions.

The battery must have a sufficient remaining capacity to ensure the clock works correctly and continues to keep the correct date if power is interrupted.

The battery discharges during the operating life of the device. The process is temperature-dependent: self-discharging is faster at high ambient temperatures.

**i** To keep self-discharging to a minimum, do not store the devices at high temperatures for a prolonged period

## 8.7.2 Setting the real-time clock

If the battery capacity is low, the error message **M434 "Real-time clock battery is empty"** is displayed

In this case, the date must be reset after every power interruption or the battery must be replaced.

**i** The battery can only be replaced by Endress+Hauser Service

### Setting the time

1. ↪ Application → Sensor → Sensor Trim Gamma

The screenshot shows a mobile application interface for 'Real time clock adjustment'. On the left, there is a breadcrumb trail: 'Sensor > Sensor Trim Gamma'. Below this, the text 'Real time clock adjustment' is displayed. On the right, there is a 'Set system time' button. Below the button, there are input fields for 'Year' (20), 'Month' (2), 'Day' (28), 'Hour' (11), and 'Minute' (25). At the bottom, there is a 'Date/time' field showing '2020-02-28 11:25:00' with a lock icon to its right. The ID 'A0042154' is visible in the bottom right corner of the screenshot.

2. The time on the clock of the operating device (connected PC or Bluetooth device) is set by pressing the "Set system time" element.

**i** Clock setting in as-delivered state: universal time coordinated (UTC).

### **WARNING**

- ▶ If the incorrect time is set, this falsifies the result of the decay compensation. This could result in a dangerous failure that cannot be diagnosed in the device.

## 8.8 Behavior in the event of low terminal voltage

### 8.8.1 General principles

If the terminal voltage is low, the available energy level may not suffice to make all functions of the device available. To ensure a reliable measurement function, the following measures are taken depending on the energy available:

- **For devices with a display (optional):** the background lighting of the display and the Bluetooth function are disabled
- **For devices without a display:** the total available energy is always available to the sensor

If the energy does not suffice to reliably guarantee the measurement function, an alarm **F801 "Increase supply voltage"** is output and the sensor function is switched off.

## 8.9 History

### 8.9.1 Firmware history

#### Firmware version

- **01.00.00**
  - Initial software
  - Valid from: August 31, 2019
- **01.00.01**
  - SIL functions certified
  - Display background lighting available
  - Valid from: February 10, 2020
- **01.00.02**
  - Certified for overflow protection according to German Water Resources Act (WHG)
  - Behavior in event of excess radiation improved
  - Behavior of display in event of low power changed (display lighting and Bluetooth are reactivated when sufficient power supply is available)
  - Errors are now shown on the display weighted according to their relevance and no longer according to when they occur
  - The Wizards for Heartbeat Verification and SIL proof-testing are now also available via Bluetooth (SmartBlue App update required)
  - Bug fixes
  - Valid from: March 1, 2021
- **01.00.03**  
Customer-specific OEM version, not publicly available
- **01.00.04**
  - Behavior in the event of no terrestrial background radiation improved
  - Initial commissioning now possible via process indicator RIA15
  - Bug fixes
  - Valid from: February 25, 2022
- **01.00.05**
  - Excess radiation alarm improved for empty pipe for density measurements
  - Possible to restore the Historom to factory settings for Endress+Hauser Service
  - Bug fixes
  - Valid from: July 1, 2022

#### **WARNING**

Firmware version 01.00.04 and 01.00.05 is not certified for overflow protection according to German Water Resources Act (WHG)

- ▶ Devices with feature 590, option LD "WHG (German Federal Water Act) overflow protection system" may only be operated with **firmware version 01.00.02**

 The firmware version can explicitly be ordered via the product structure. In this way it is possible to ensure compatibility of the firmware version with an existing or planned system integration.

### 8.9.2 Hardware history

#### Hardware version

- **01.00.00** -> initial hardware  
Valid from: August 31, 2019
- **01.00.01** -> display background lighting available (it may be necessary to update the display firmware)  
Valid from: February 10, 2020

## 9 Maintenance and repair

### 9.1 Cleaning

When cleaning the exterior, always use cleaning agents that do not corrode the surface of the housing and the seals.

### 9.2 Repair

#### 9.2.1 Repair concept

Under the Endress+Hauser repair concept, devices have a modular design and repairs can be carried out by Endress+Hauser Service or by properly trained customers.

Spare parts are grouped into logical kits with the associated replacement instructions.

For more information on service and spare parts, please contact Endress+Hauser Service.

#### 9.2.2 Repairs to devices with an Ex-certificate

**When repairing devices with an Ex-certificate, please also note the following:**

- Only specialist personnel or Endress+Hauser Service may carry out repairs on Ex-certified devices.
- Comply with the prevailing standards, national Ex-area regulations, Safety Instructions (XA) and certificates.
- Only use original spare parts from Endress+Hauser.
- A certified device may only be converted into a different certified device version by Endress +Hauser Service in Endress+Hauser workshops.
- Document Ex-related repairs and Ex-related modifications.

 Observe the information in the "Functional Safety Manual" for SIL devices

### 9.3 Replacement

#### CAUTION

**Data upload/download is not permitted if the device is used for safety-related applications.**

- ▶ After an entire device or an electronics module has been replaced, the parameters can be downloaded to the device again via the communication interface. For this, the data must have been uploaded to the PC beforehand using the "FieldCare/DeviceCare" software.

#### 9.3.1 Level measurement and point level detection

You can continue measuring without performing a new calibration. However, the calibration values should be checked as soon as possible since the mounting position may have changed slightly.

#### 9.3.2 Density and concentration measurement

A new calibration must be performed after the replacement.

### 9.3.3 HistoROM

It is not necessary to perform a new device calibration after replacing the display or transmitter electronics. The parameters are saved in the HistoROM.

 After replacing the transmitter electronics, remove the HistoROM and insert it into the new replacement part.

 Please contact the Endress+Hauser Service Department if the HistoROM is lost or defective.

## 9.4 Spare parts

Enter the serial number into *W@M Device Viewer* ([www.endress.com/deviceviewer](http://www.endress.com/deviceviewer)).

All the spare parts for the measuring device, along with the order code, are listed here and can be ordered. If available, users can also download the associated Installation Instructions.

 Serial number:

- Located on the device and spare part nameplate.
- Can be read out via the "Serial number" parameter in the "Device information" submenu.

## 9.5 Return

The measuring device must be returned if it is in need of repair or a factory calibration, or if the wrong measuring device has been delivered or ordered. Legal specifications require Endress+Hauser, as an ISO-certified company, to follow certain procedures when handling products that are in contact with the medium.

To ensure safe, swift and professional device returns, please refer to the procedure and conditions for returning devices provided on the Endress+Hauser website at <http://www.endress.com/support/return-material>

## 9.6 Disposal



If required by the Directive 2012/19/EU on waste electrical and electronic equipment (WEEE), our products are marked with the depicted symbol in order to minimize the disposal of WEEE as unsorted municipal waste. Such products may not be disposed of as unsorted municipal waste and can be returned to Endress+Hauser for disposal at conditions stipulated in our General Terms and Conditions or as individually agreed.

### 9.6.1 Battery disposal

- The end user is legally obliged to return used batteries.
- The end user can return old batteries or electronic assemblies containing these batteries free of charge to Endress+Hauser.



In accordance with German law regulating the use of batteries (BattG §28 Para 1 Number 3), this symbol is used to denote electronic assemblies that must not be disposed of as household waste.

## 9.7 Contact addresses at Endress+Hauser

Contact addresses are available at [www.endress.com/worldwide](http://www.endress.com/worldwide) or from your local Endress+Hauser branch office.

## 10 Accessories

### 10.1 Commubox FXA195 HART

For intrinsically safe HART communication with FieldCare/DeviceCare via the USB interface. For details refer to



TI00404F

### 10.2 Field Xpert SFX350, SFX370, SMT70

Compact, flexible and robust industrial handheld terminal for remote operation and measured value interrogation of HART devices. For details refer to



BA01202S



TI01114S



## 10.3 Mounting device (for level and point level measurement)

### 10.3.1 Mounting the retaining bracket

Reference dimension A is used to define the mounting location of the retaining bracket depending on the measuring range.

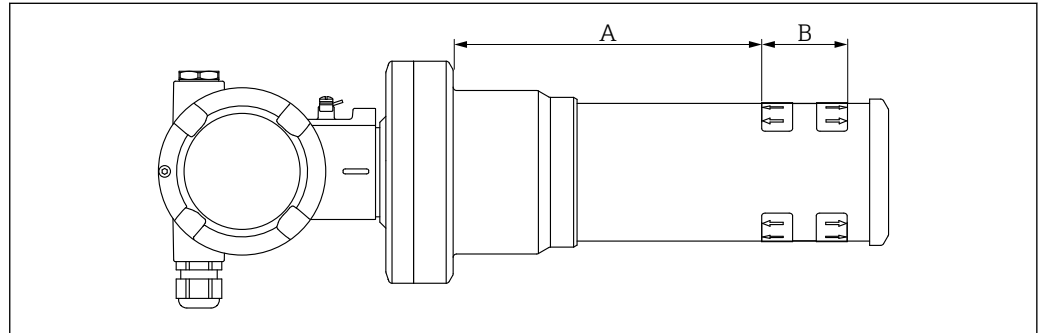

A0040283

▣ 26 A defines the distance between the device flange and the start of the measuring range. Distance A depends on the material of the scintillator (PVT or NaI).

A: PVT, distance : 172 mm (6.77 in)

A: NaI, distance : 180 mm (7.09 in)

B: Position and length of the measuring range

### 10.3.2 Mounting instructions

**i** Keep the distance between the mounting clamps as large as possible

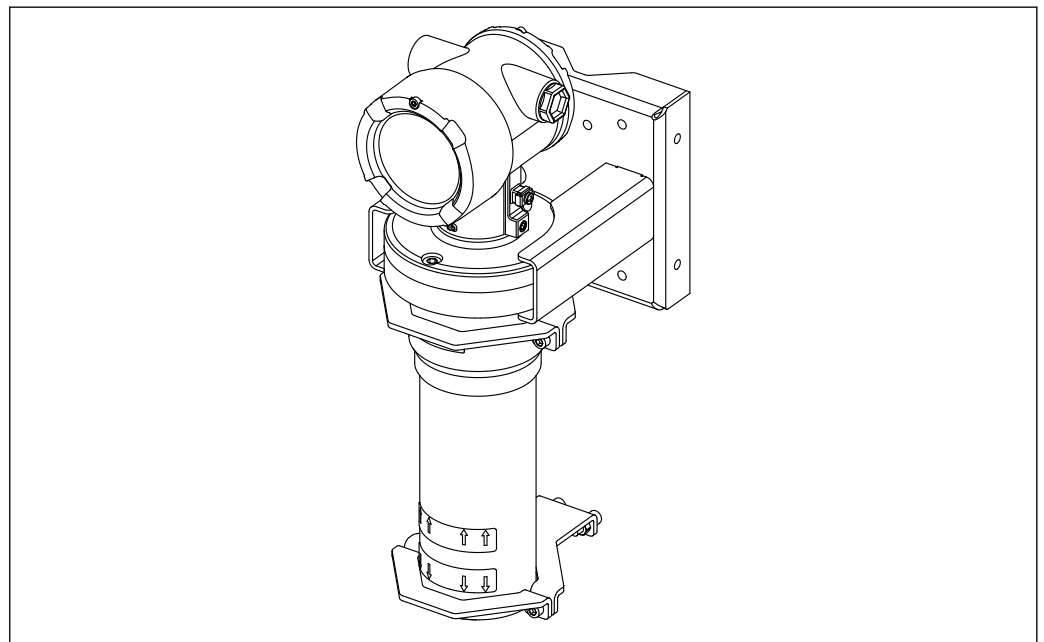

A0039103

▣ 27 Installation overview, with mounting clamps and retaining bracket

### Dimensions of mounting clamps

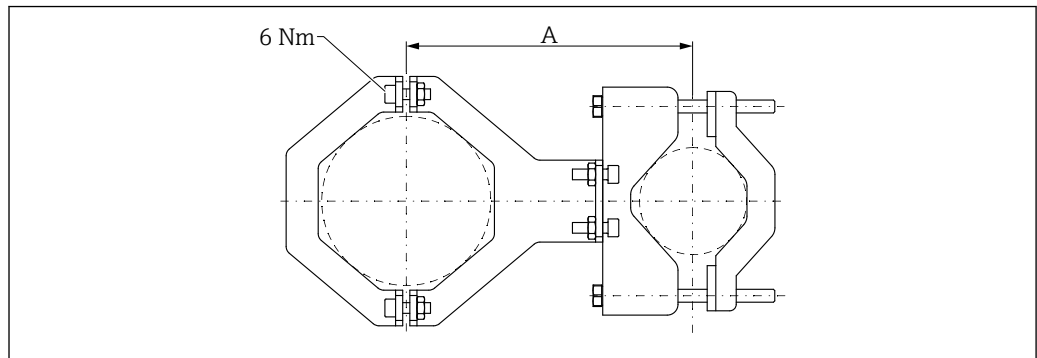

A0042084

28 Dimensions of mounting clamp

#### Distance A

- For electronics pipe: 210 mm (8.27 in)
- For detector pipe: 198 mm (7.8 in)

#### **CAUTION**

#### Max. torque for the screws of the retainers:

- ▶ 6 Nm (4.42 lbf ft)

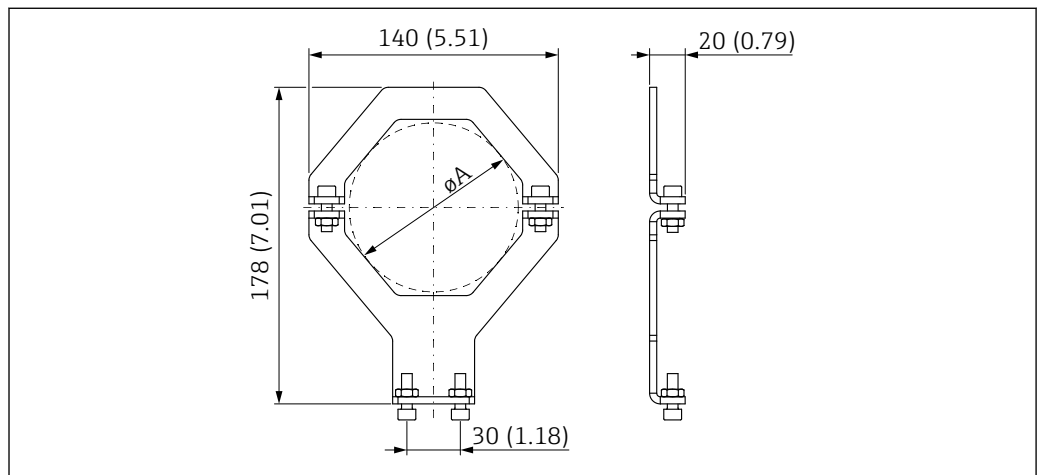

A0040029

29 Dimensions of mounting clamp

#### Diameter A

- Electronics pipe: 95 mm (3.74 in)
- Detector pipe: 80 mm (3.15 in)

**Dimensions of pole mount**

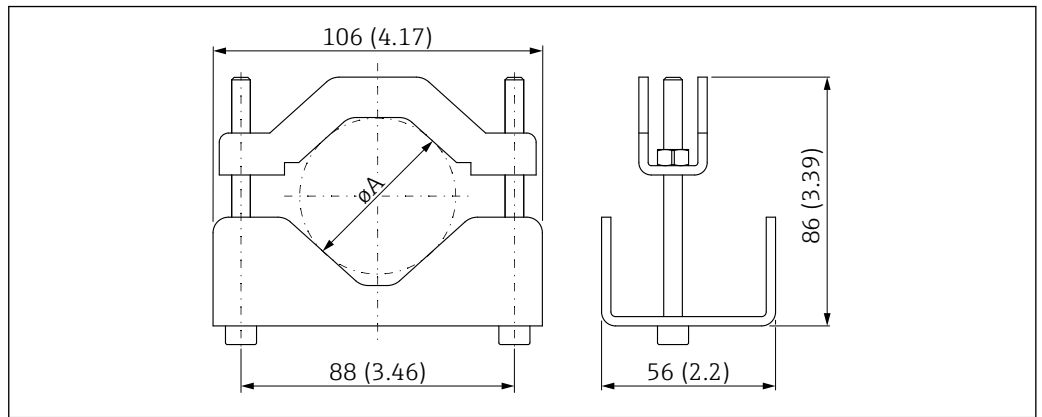

A0040266

30  $\phi A$ : 40 to 65 mm (1.57 to 2.56 in)

**Dimensions of retaining bracket**

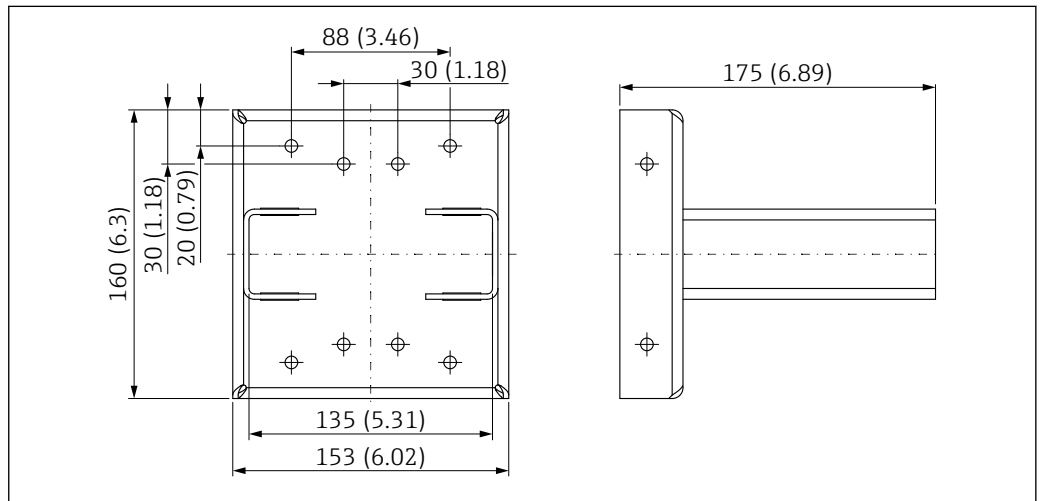

A0040030

31 Retaining bracket

### 10.3.3 Use

✔ Permitted

✘ Not recommended, observe mounting instructions

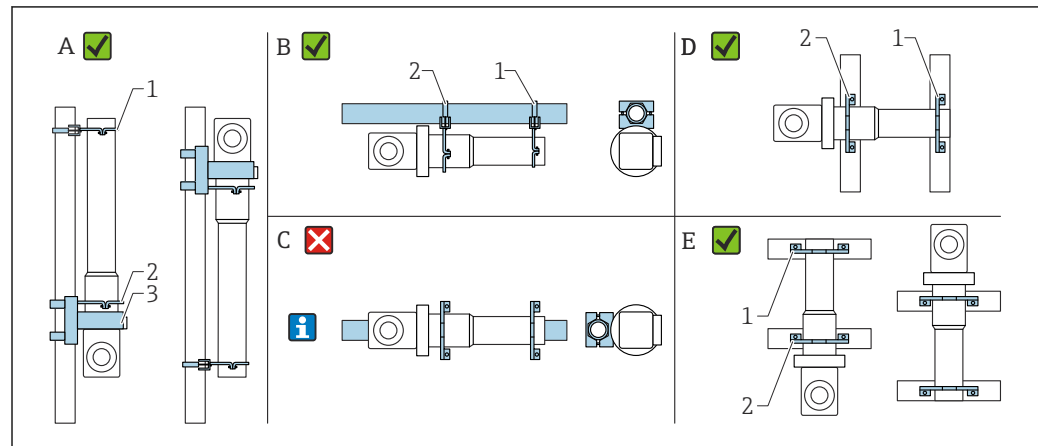

A0037727

- A Level measurement, FMG50  
 B Point level measurement, FMG50  
 C Such horizontal mounting is not recommended  
 1 Retainer for pipe diameter 80 mm (3.15 in)  
 2 Retainer for pipe diameter 95 mm (3.74 in)  
 3 Retaining bracket

**i** **Mounting instructions for horizontal mounting (see Figure C):** The pipe must be mounted by the customer. It is important to ensure that the installation clamping power is sufficient to prevent the FMG50 from slipping. The dimensions are provided in the "Dimensions of the mounting clamps" section.

#### **CAUTION**

##### Note the following when mounting the device

- ▶ The mounting device must be installed in such a way as to withstand the weight of the Gammapilot FMG50 under all anticipated operating conditions.
- ▶ Four brackets must be used for measuring lengths of 1 600 mm (63 in) and more.
- ▶ To facilitate installation and commissioning, the Gammapilot FMG50 can be configured and ordered with an additional support (order feature 620, option Q4: "Retaining bracket").
- ▶ Clamping solution for pipe mounting must be provided by the customer on site (see Figure C). Do not use the enclosed mounting clamps for a horizontal pipe. The fixing bracket supplied can be used for FMG50.
- ▶ To prevent damage to the detector pipe of the Gammapilot FMG50, the maximum torque that can be applied to tighten the retainer screws is 6 Nm (4.42 lbf ft).

## 10.4 Clamping device for density measurement FHG51

### 10.4.1 FHG51-A#1

For pipes with diameter 50 to 200 mm (2 to 8 in).

SD02543F

### 10.4.2 FHG51-A#1PA

For pipes with diameter 50 to 200 mm (2 to 8 in) with protective guard.

 SD02533F

### 10.4.3 FHG51-B#1

For pipes with diameter 200 to 420 mm (8 to 16.5 in).

 SD02544F

### 10.4.4 FHG51-B#1PB

For pipes with diameter 200 to 420 mm (8 to 16.5 in) with protective guard.

 SD02534F

### 10.4.5 FHG51-E#1

For pipes with diameter 48 to 77 mm (1.89 to 3.03 in) and FQG60.

 SD02557F

### 10.4.6 FHG51-F#1

For pipes with diameter 80 to 273 mm (3.15 to 10.75 in) and FQG60.

 SD02558F

## 10.5 Collimator (sensor side) for Gammapilot FMG50

### 10.5.1 Intended use

The collimator can be used to increase measuring accuracy.

The collimator reduces interference radiation (e.g. from gammagraphy or scattered radiation) and background radiation at the detector. It only allows gamma radiation coming from the direction of the useful beam source to pass to the Gammapilot FMG50 detector and reliably shields interference radiation from the environment. The collimator consists of a lead jacket that effectively shields the radiation-sensitive measuring range of the Gammapilot FMG50. The lead jacket has a side opening and is suitable for the lateral radiation of the Gammapilot FMG50 with the 2" NaI(Tl) scintillator.

For safety reasons, the lead jacket is accommodated in a stainless steel housing and is safe against accidental touch.

 Please contact an Endress+Hauser sales organization for applications with frontal radiation or other scintillator versions

### 10.5.2 Additional information

 Additional information is available in:  
SD02822F

## 10.6 Process indicator RIA15

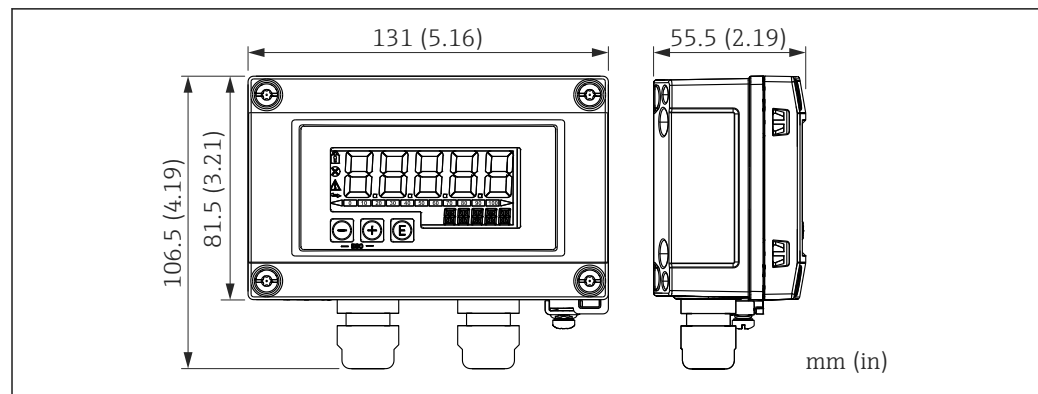

32 Dimensions of RIA15 in field housing, engineering unit: mm (in)

**i** The RIA15 remote indicator can be ordered together with the device.

- Option PE "Remote indicator RIA15, non-hazardous area, aluminum field housing"
- Option PF "Remote indicator RIA15, hazardous, aluminum field housing"

Field housing material: aluminum

Other housing versions are available via the RIA15 product structure.

**i** Alternatively available as an accessory, for details see Technical Information TI01043K and Operating Instructions BA01170K

### 10.6.1 HART communication resistor

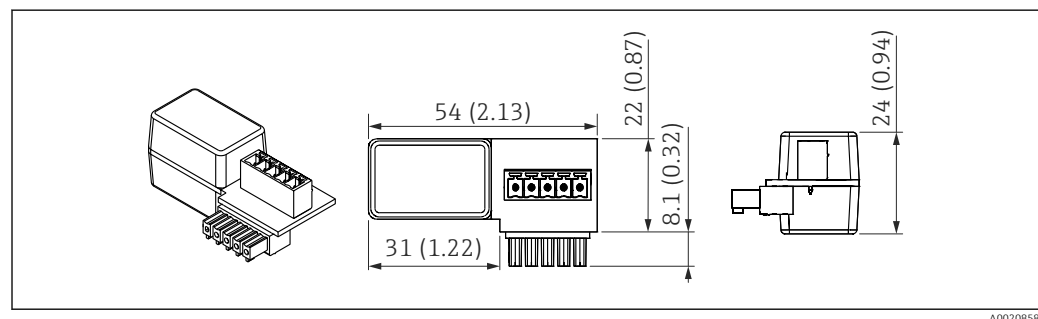

33 Dimensions of HART communication resistor, engineering unit: mm (in)

**i** A communication resistor is required for HART communication. If this is not already present (e.g. in the power supply RMA42, RN221N, RNS221, ...), it can be ordered with the device via the product structure, feature 620 "Accessory enclosed": option R6 "HART communication resistor hazardous / non-hazardous area".

## 10.7 Memograph M RSG45

### 10.7.1 Level measurement: FMG50 with Memograph M RSG45

Conditions requiring several FMG50 units:

- Large measuring ranges
- Special tank geometry

More than two FMG50 units (maximum 20) can be interconnected and powered via one Memograph M RSG45. The pulse rates (cnt/s) of the individual FMG50 units are added together and linearized; this gives the total level.

To enable the application, the settings must be made on every FMG50. In this way, the actual level in the vessel can be determined over all the anticipated cascade areas. While the calculation is the same for all FMG50 devices in the cascade, the constants for every FMG50 unit vary and must remain editable.

- i** The cascade mode requires at least 2 FMG50 units that communicate with the RSG45 via the HART channel.
- i** Avoid overlap between the individual measuring ranges as this can result in an incorrect measured value. The devices can overlap provided this does not affect the measuring ranges.

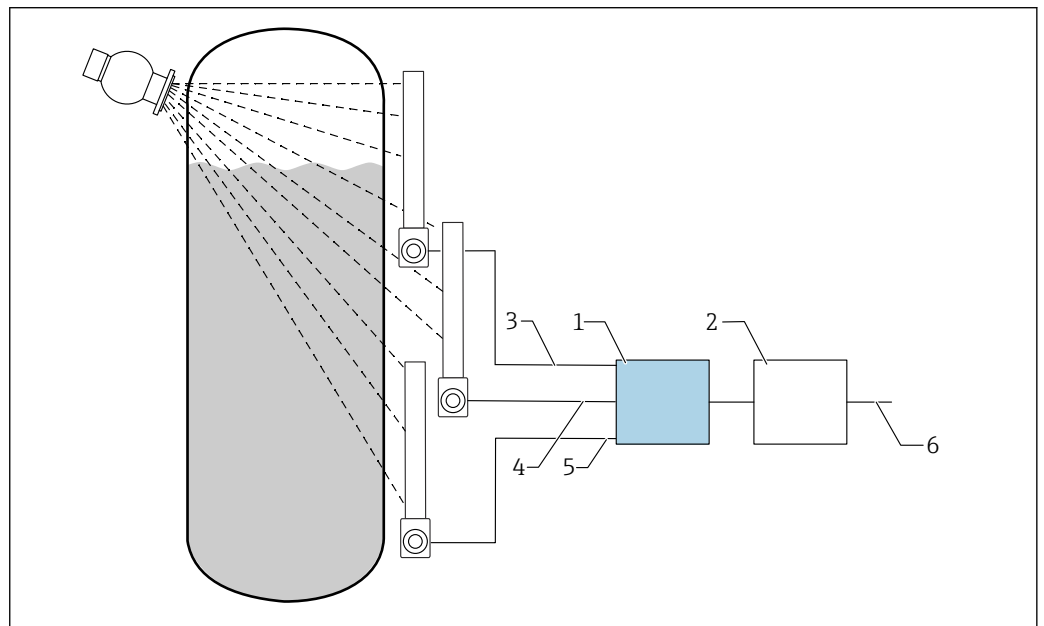

**34** Connection diagram: for three FMG50 units (up to 20 FMG50s) connected to one RSG45

- 1 RSG45
- 2 Algorithm: addition of the individual pulse rates ( $SV_1 + SV_2 + SV_3$ ) and subsequent linearization
- 3 HART signal FMG50 (1), PV\_1: level, SV\_1: pulse rate (cnt/s)
- 4 HART signal FMG50 (2), PV\_2: level, SV\_2: pulse rate (cnt/s)
- 5 HART signal FMG50 (3), PV\_3: level, SV\_3: pulse rate (cnt/s)
- 6 Overall output signal

### 10.7.2 Additional information

- i** See Operating Instructions RSG45 :  
BA01338R
- i** See Operating Instructions FMG50:  
BA01966F

## 10.8 Weather protection cover for dual compartment housing, aluminum

- Material: stainless steel 316L
- Order number: 71438303

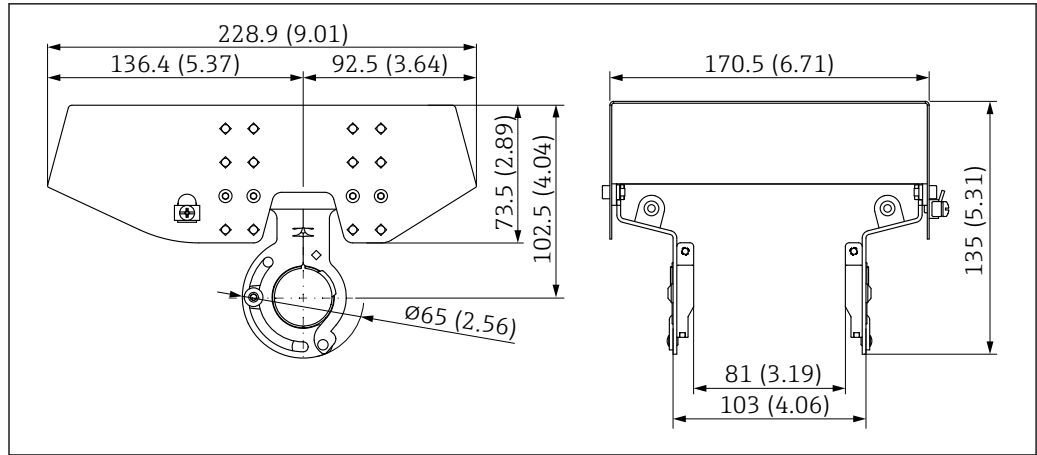

A0039231

35 Weather protection cover for dual compartment housing, aluminum. Unit of measurement mm (in)



## 10.9 Heat shield for Gammapilot FMG50

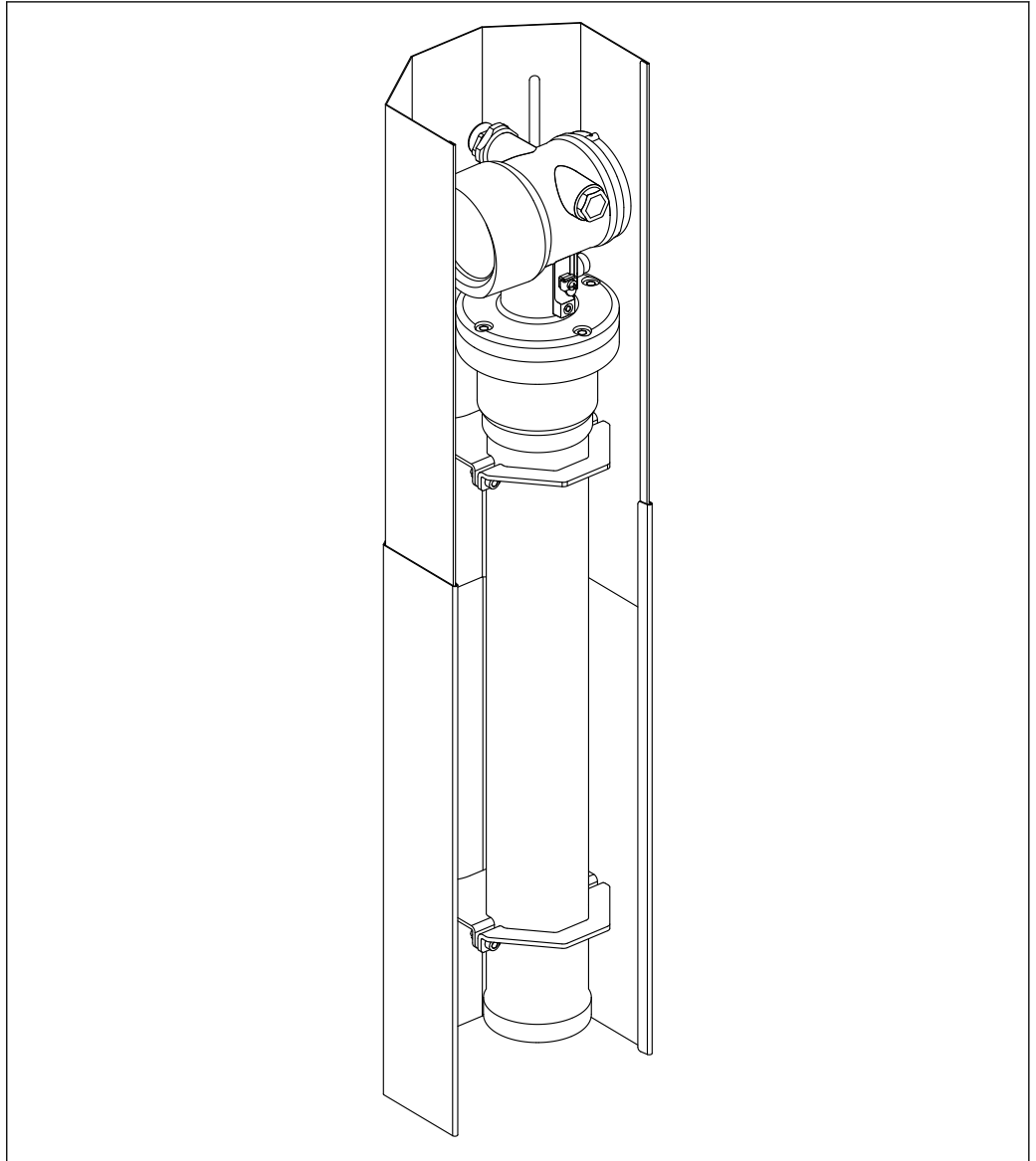

A0041149

36 Example of a heat shield for Gammapilot FMG50

 For more information, see:

 SD02472F

## 11 Technical data

### 11.1 Additional technical data

For additional technical data, see "Technical Information FMG50"

### 11.2 Supplementary documentation

The supplementary documentation is available on our product pages at "[www.endress.com](http://www.endress.com)"

- Technical Information
- "Description of Device Functions" manual
- Functional Safety Manual:
- Special Documentation "Heartbeat Verification + Monitoring"

#### 11.2.1 Modulator FHG65

 BA00373F

#### 11.2.2 Source container FQG60

 TI00445F

#### 11.2.3 Source container FQG61, FQG62

 TI00435F

#### 11.2.4 Source container FQG63

 TI00446F

#### 11.2.5 Source container FQG66

 TI01171F  
BA01327F

#### 11.2.6 Clamping device FHG51

 SD02533F (clamping device for density measurement with protective guard)  
SD02534F (clamping device for density measurement with protective guard)  
SD02543F (clamping device for density measurement)  
SD02544F (clamping device for density measurement)

#### 11.2.7 Mounting device for Gammapilot FMG50

 SD02454F

#### 11.2.8 Heat shield for Gammapilot FMG50

 SD02472F

### 11.2.9 Weather protection cover for dual-compartment housing

 SD02424F

### 11.2.10 VU101 Bluetooth® display

 SD02402F

### 11.2.11 Process indicator RIA15

 TI01043K

### 11.2.12 Memograph M, RSG45

 TI01180R

### 11.2.13 Collimator (sensor side) for Gammapilot FMG50

 Under development

## 12 Certificates and approvals

 The availability of approvals and certificates can be called up daily via the Product Configurator.

### 12.1 Functional safety

SIL 2/3 according to IEC 61508, see:  
"Functional Safety Manual"



FY01007F

### 12.2 Heartbeat Monitoring + Verification

Heartbeat Technology offers diagnostic functionality through continuous self-monitoring, the transmission of additional measured variables to an external Condition Monitoring system and the in-situ verification of measuring devices in the application.  
Special Documentation "Heartbeat Monitoring + Verification"



SD02414F

### 12.3 Ex approval

The Ex certificates available are listed in the ordering information. Observe the related Safety Instructions (XA) and Control Drawings (ZD).

#### 12.3.1 Explosion-protected smartphones and tablets

Only mobile end devices with Ex approval may be used in hazardous areas.

### 12.4 Other standards and guidelines

- **IEC 60529**  
Degrees of protection provided by enclosures (IP code)
- **IEC 61010**  
Safety requirements for electrical equipment for measurement, control and laboratory use
- **IEC 61326**  
Interference emission (Class B equipment), interference immunity (Annex A – Industrial area)
- **IEC 61508**  
Functional safety of safety-related electric/electronic/programmable electronic systems
- **NAMUR**  
Association for Standards for Control and Regulation in the Chemical Industry

### 12.5 Certificates

The certificates are available via the Product Configurator:

[www.us.endress.com/en/field-instruments-overview/product-finder](http://www.us.endress.com/en/field-instruments-overview/product-finder) -> Select product -> Configure

## **12.6 CE mark**

The measuring system meets the legal requirements of the EU Directives. Endress+Hauser confirms that the device has been successfully tested by applying the CE mark.

## **12.7 EAC**

Approval for EAC

## **12.8 Overfill prevention**

WHG (German Water Resources Act) for point level detection



[www.addresses.endress.com](http://www.addresses.endress.com)

---