

# Operating Instructions

## Proline Promass S 500

Coriolis flowmeter  
PROFIBUS DP

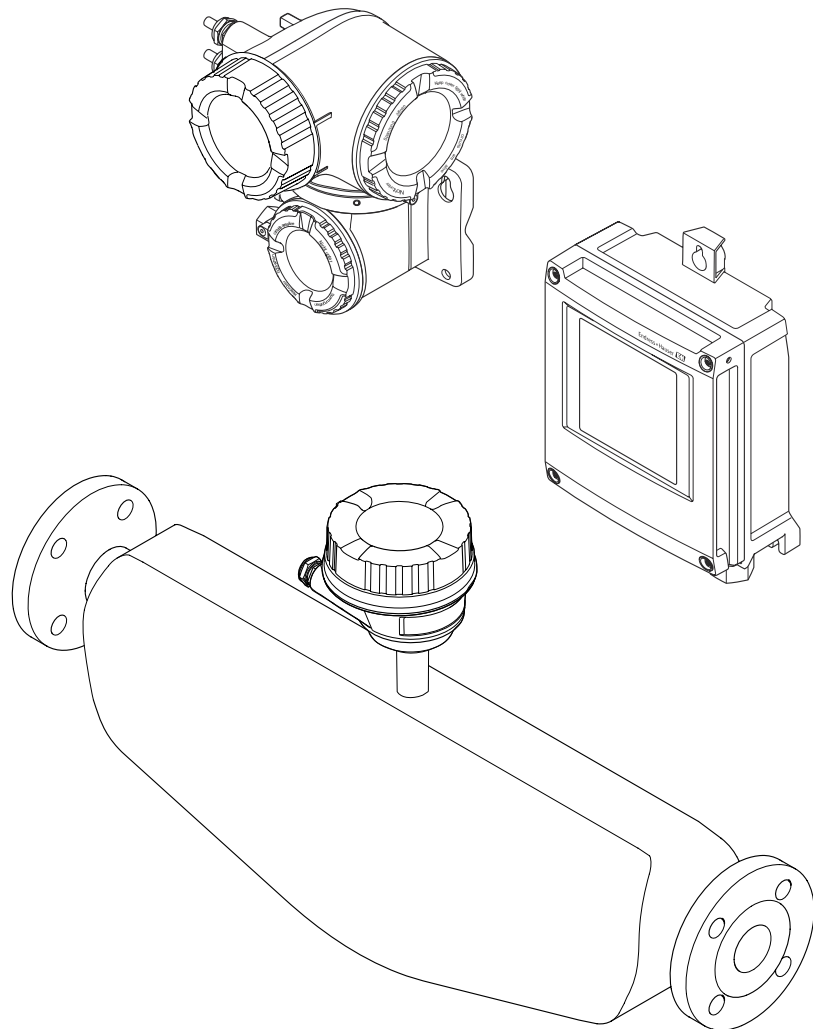

- Make sure the document is stored in a safe place such that it is always available when working on or with the device.
- To avoid danger to individuals or the facility, read the "Basic safety instructions" section carefully, as well as all other safety instructions in the document that are specific to working procedures.
- The manufacturer reserves the right to modify technical data without prior notice. Your Endress+Hauser Sales Center will supply you with current information and updates to these instructions.

## Table of contents

<b>1</b>	<b>About this document</b> . . . . .	<b>6</b>	<b>6</b>	<b>Installation</b> . . . . .	<b>23</b>
1.1	Document function . . . . .	6	6.1	Installation conditions . . . . .	23
1.2	Symbols . . . . .	6	6.1.1	Mounting position . . . . .	23
1.2.1	Safety symbols . . . . .	6	6.1.2	Environmental and process requirements . . . . .	26
1.2.2	Electrical symbols . . . . .	6	6.1.3	Special mounting instructions . . . . .	27
1.2.3	Communication symbols . . . . .	6	6.2	Mounting the measuring device . . . . .	29
1.2.4	Tool symbols . . . . .	7	6.2.1	Required tools . . . . .	29
1.2.5	Symbols for certain types of information . . . . .	7	6.2.2	Preparing the measuring device . . . . .	29
1.2.6	Symbols in graphics . . . . .	7	6.2.3	Mounting the measuring device . . . . .	30
1.3	Documentation . . . . .	8	6.2.4	Mounting the transmitter housing: Proline 500 – digital . . . . .	30
1.3.1	Standard documentation . . . . .	8	6.2.5	Mounting the transmitter housing: Proline 500 . . . . .	32
1.3.2	Supplementary device-dependent documentation . . . . .	8	6.2.6	Turning the transmitter housing: Proline 500 . . . . .	33
1.4	Registered trademarks . . . . .	8	6.2.7	Turning the display module: Proline 500 . . . . .	33
<b>2</b>	<b>Safety instructions</b> . . . . .	<b>10</b>	6.3	Post-installation check . . . . .	34
2.1	Requirements for the personnel . . . . .	10	<b>7</b>	<b>Electrical connection</b> . . . . .	<b>35</b>
2.2	Designated use . . . . .	10	7.1	Connection conditions . . . . .	35
2.3	Workplace safety . . . . .	11	7.1.1	Required tools . . . . .	35
2.4	Operational safety . . . . .	11	7.1.2	Requirements for connecting cable . . . . .	35
2.5	Product safety . . . . .	11	7.1.3	Terminal assignment . . . . .	40
2.6	IT security . . . . .	12	7.1.4	Shielding and grounding . . . . .	40
2.7	Device-specific IT security . . . . .	12	7.1.5	Preparing the measuring device . . . . .	41
2.7.1	Protecting access via hardware write protection . . . . .	12	7.2	Connecting the measuring device: Proline 500 - digital . . . . .	43
2.7.2	Protecting access via a password . . . . .	12	7.2.1	Connecting the connecting cable . . . . .	43
2.7.3	Access via Web server . . . . .	13	7.2.2	Connecting the signal cable and the supply voltage cable . . . . .	48
2.7.4	Access via service interface (CDI-RJ45) . . . . .	14	7.3	Connecting the measuring device: Proline 500 . . . . .	50
<b>3</b>	<b>Product description</b> . . . . .	<b>15</b>	7.3.1	Connecting the connecting cable . . . . .	50
3.1	Product design . . . . .	15	7.4	Ensuring potential equalization . . . . .	52
3.1.1	Proline 500 – digital . . . . .	15	7.4.1	Requirements . . . . .	52
3.1.2	Proline 500 . . . . .	16	7.5	Special connection instructions . . . . .	53
<b>4</b>	<b>Incoming acceptance and product identification</b> . . . . .	<b>17</b>	7.5.1	Connection examples . . . . .	53
4.1	Incoming acceptance . . . . .	17	7.6	Hardware settings . . . . .	56
4.2	Product identification . . . . .	17	7.6.1	Setting the device address . . . . .	56
4.2.1	Transmitter nameplate . . . . .	18	7.6.2	Enabling the terminating resistor . . . . .	57
4.2.2	Sensor nameplate . . . . .	20	7.6.3	Activating the default IP address . . . . .	58
4.2.3	Symbols on measuring device . . . . .	21	7.7	Ensuring the degree of protection . . . . .	60
<b>5</b>	<b>Storage and transport</b> . . . . .	<b>22</b>	7.8	Post-connection check . . . . .	60
5.1	Storage conditions . . . . .	22	<b>8</b>	<b>Operation options</b> . . . . .	<b>61</b>
5.2	Transporting the product . . . . .	22	8.1	Overview of operation options . . . . .	61
5.2.1	Measuring devices without lifting lugs . . . . .	22	8.2	Structure and function of the operating menu . . . . .	62
5.2.2	Measuring devices with lifting lugs . . . . .	23	8.2.1	Structure of the operating menu . . . . .	62
5.2.3	Transporting with a fork lift . . . . .	23	8.2.2	Operating philosophy . . . . .	63
5.3	Packaging disposal . . . . .	23			

8.3	Access to the operating menu via the local display .....	64	<b>10</b>	<b>Commissioning .....</b>	<b>102</b>
8.3.1	Operational display .....	64	10.1	Function check .....	102
8.3.2	Navigation view .....	66	10.2	Switching on the measuring device .....	102
8.3.3	Editing view .....	68	10.3	Connecting via FieldCare .....	102
8.3.4	Operating elements .....	70	10.4	Configuring the device address via software ..	102
8.3.5	Opening the context menu .....	70	10.4.1	PROFIBUS network .....	102
8.3.6	Navigating and selecting from list ...	72	10.5	Setting the operating language .....	102
8.3.7	Calling the parameter directly .....	72	10.6	Configuring the measuring device .....	103
8.3.8	Calling up help text .....	73	10.6.1	Defining the tag name .....	104
8.3.9	Changing the parameters .....	73	10.6.2	Setting the system units .....	105
8.3.10	User roles and related access authorization .....	74	10.6.3	Selecting and setting the medium ..	108
8.3.11	Disabling write protection via access code .....	74	10.6.4	Configuring communication interface .....	108
8.3.12	Enabling and disabling the keypad lock .....	75	10.6.5	Configuring the analog inputs .....	110
8.4	Access to the operating menu via the Web browser .....	75	10.6.6	Displaying the I/O configuration ...	111
8.4.1	Function range .....	75	10.6.7	Configuring the current input .....	112
8.4.2	Prerequisites .....	76	10.6.8	Configuring the status input .....	113
8.4.3	Establishing a connection .....	77	10.6.9	Configuring the current output .....	114
8.4.4	Logging on .....	79	10.6.10	Configuring the pulse/frequency/switch output .....	117
8.4.5	User interface .....	80	10.6.11	Configuring the relay output .....	124
8.4.6	Disabling the Web server .....	81	10.6.12	Configuring the local display .....	126
8.4.7	Logging out .....	81	10.6.13	Configuring the low flow cut off ...	129
8.5	Access to the operating menu via the operating tool .....	82	10.6.14	Configuring the partial filled pipe detection .....	130
8.5.1	Connecting the operating tool .....	82	10.7	Advanced settings .....	131
8.5.2	FieldCare .....	85	10.7.1	Calculated values .....	132
8.5.3	DeviceCare .....	86	10.7.2	Carrying out a sensor adjustment ...	133
<b>9</b>	<b>System integration .....</b>	<b>88</b>	10.7.3	Configuring the totalizer .....	134
9.1	Overview of device description files .....	88	10.7.4	Carrying out additional display configurations .....	136
9.1.1	Current version data for the device ...	88	10.7.5	WLAN configuration .....	139
9.1.2	Operating tools .....	88	10.7.6	Configuration management .....	140
9.2	Device master file (GSD) .....	88	10.7.7	Using parameters for device administration .....	141
9.2.1	Manufacturer-specific GSD .....	89	10.8	Simulation .....	143
9.2.2	Profile GSD .....	89	10.9	Protecting settings from unauthorized access	146
9.3	Compatibility with earlier model .....	89	10.9.1	Write protection via access code ...	146
9.3.1	Automatic identification (factory setting) .....	89	10.9.2	Write protection via write protection switch .....	147
9.3.2	Manual setting .....	90	<b>11</b>	<b>Operation .....</b>	<b>150</b>
9.3.3	Replacing the measuring devices without changing the GSD file or restarting the controller .....	90	11.1	Reading the device locking status .....	150
9.4	Using the GSD modules of the previous model .....	90	11.2	Adjusting the operating language .....	150
9.4.1	Using the CONTROL_BLOCK module in the previous model .....	91	11.3	Configuring the display .....	150
9.5	Cyclic data transmission .....	92	11.4	Reading measured values .....	150
9.5.1	Block model .....	92	11.4.1	"Measured variables" submenu .....	151
9.5.2	Description of the modules .....	92	11.4.2	Totalizer .....	152
9.6	Address shifting configuration .....	99	11.4.3	"Input values" submenu .....	153
9.6.1	Function description .....	99	11.4.4	Output values .....	154
9.6.2	Structure .....	99	11.5	Adapting the measuring device to the process conditions .....	156
9.6.3	Configuring address shifting .....	100	11.6	Performing a totalizer reset .....	156
9.6.4	Accessing data via PROFIBUS DP ...	100	11.7	Showing data logging .....	157
			<b>12</b>	<b>Diagnostics and troubleshooting ..</b>	<b>161</b>
			12.1	General troubleshooting .....	161



12.2	Diagnostic information via light emitting diodes . . . . .	164	<b>16</b>	<b>Technical data . . . . .</b>	<b>239</b>
12.2.1	Transmitter . . . . .	164	16.1	Application . . . . .	239
12.2.2	Sensor connection housing . . . . .	166	16.2	Function and system design . . . . .	239
12.3	Diagnostic information on local display . . . . .	167	16.3	Input . . . . .	240
12.3.1	Diagnostic message . . . . .	167	16.4	Output . . . . .	242
12.3.2	Calling up remedial measures . . . . .	169	16.5	Power supply . . . . .	247
12.4	Diagnostic information in the Web browser . . . . .	169	16.6	Performance characteristics . . . . .	248
12.4.1	Diagnostic options . . . . .	169	16.7	Installation . . . . .	252
12.4.2	Calling up remedy information . . . . .	170	16.8	Environment . . . . .	252
12.5	Diagnostic information in FieldCare or DeviceCare . . . . .	170	16.9	Process . . . . .	254
12.5.1	Diagnostic options . . . . .	170	16.10	Mechanical construction . . . . .	256
12.5.2	Calling up remedy information . . . . .	171	16.11	Human interface . . . . .	259
12.6	Adapting the diagnostic information . . . . .	172	16.12	Certificates and approvals . . . . .	263
12.6.1	Adapting the diagnostic behavior . . . . .	172	16.13	Application packages . . . . .	265
12.7	Overview of diagnostic information . . . . .	175	16.14	Accessories . . . . .	266
12.7.1	Diagnostic of sensor . . . . .	175	16.15	Supplementary documentation . . . . .	266
12.7.2	Diagnostic of electronic . . . . .	182			
12.7.3	Diagnostic of configuration . . . . .	199	<b>Index . . . . .</b>	<b>269</b>	
12.7.4	Diagnostic of process . . . . .	213			
12.8	Pending diagnostic events . . . . .	226			
12.9	Diagnostic list . . . . .	226			
12.10	Event logbook . . . . .	227			
12.10.1	Reading out the event logbook . . . . .	227			
12.10.2	Filtering the event logbook . . . . .	228			
12.10.3	Overview of information events . . . . .	228			
12.11	Resetting the measuring device . . . . .	229			
12.11.1	Function scope of the "Device reset" parameter . . . . .	230			
12.12	Device information . . . . .	230			
12.13	Firmware history . . . . .	232			
<b>13</b>	<b>Maintenance . . . . .</b>	<b>233</b>			
13.1	Maintenance tasks . . . . .	233			
13.1.1	Exterior cleaning . . . . .	233			
13.1.2	Interior cleaning . . . . .	233			
13.2	Measuring and test equipment . . . . .	233			
13.3	Endress+Hauser services . . . . .	233			
<b>14</b>	<b>Repair . . . . .</b>	<b>234</b>			
14.1	General notes . . . . .	234			
14.1.1	Repair and conversion concept . . . . .	234			
14.1.2	Notes for repair and conversion . . . . .	234			
14.2	Spare parts . . . . .	234			
14.3	Endress+Hauser services . . . . .	234			
14.4	Return . . . . .	234			
14.5	Disposal . . . . .	235			
14.5.1	Removing the measuring device . . . . .	235			
14.5.2	Disposing of the measuring device . . . . .	235			
<b>15</b>	<b>Accessories . . . . .</b>	<b>236</b>			
15.1	Device-specific accessories . . . . .	236			
15.1.1	For the transmitter . . . . .	236			
15.1.2	For the sensor . . . . .	237			
15.2	Service-specific accessories . . . . .	238			
15.3	System components . . . . .	238			

# 1 About this document

## 1.1 Document function

These Operating Instructions contain all the information that is required in various phases of the life cycle of the device: from product identification, incoming acceptance and storage, to mounting, connection, operation and commissioning through to troubleshooting, maintenance and disposal.

## 1.2 Symbols

### 1.2.1 Safety symbols

#### **DANGER**

This symbol alerts you to a dangerous situation. Failure to avoid this situation will result in serious or fatal injury.

#### **WARNING**

This symbol alerts you to a dangerous situation. Failure to avoid this situation can result in serious or fatal injury.





#### **CAUTION**

This symbol alerts you to a dangerous situation. Failure to avoid this situation can result in minor or medium injury.



#### **NOTICE**



This symbol contains information on procedures and other facts which do not result in personal injury.

### 1.2.2 Electrical symbols



Symbol	Meaning
	Direct current
	Alternating current
	Direct current and alternating current
	<b>Ground connection</b> A grounded terminal which, as far as the operator is concerned, is grounded via a grounding system.
	<b>Protective Earth (PE)</b> A terminal which must be connected to ground prior to establishing any other connections.  The ground terminals are situated inside and outside the device: <ul style="list-style-type: none"> <li>▪ Inner ground terminal: Connects the protective earth to the mains supply.</li> <li>▪ Outer ground terminal: Connects the device to the plant grounding system.</li> </ul>

### 1.2.3 Communication symbols













Symbol	Meaning
	<b>Wireless Local Area Network (WLAN)</b> Communication via a wireless, local network.
	<b>LED</b> Light emitting diode is off.

Symbol	Meaning
	<b>LED</b> Light emitting diode is on.
	<b>LED</b> Light emitting diode is flashing.





#### 1.2.4 Tool symbols



Symbol	Meaning
	Torx screwdriver
	Phillips head screwdriver
	Open-ended wrench

#### 1.2.5 Symbols for certain types of information

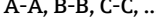
Symbol	Meaning
	<b>Permitted</b> Procedures, processes or actions that are permitted.
	<b>Preferred</b> Procedures, processes or actions that are preferred.
	<b>Forbidden</b> Procedures, processes or actions that are forbidden.
	<b>Tip</b> Indicates additional information.
	Reference to documentation.
	Reference to page.
	Reference to graphic.
	Notice or individual step to be observed.
	Series of steps.
	Result of a step.
	Help in the event of a problem.
	Visual inspection.

#### 1.2.6 Symbols in graphics



Symbol	Meaning
	Item numbers
	Series of steps
	Views
	Sections
	Hazardous area

Symbol	Meaning
	Safe area (non-hazardous area)
	Flow direction

## 1.3 Documentation

 For an overview of the scope of the associated Technical Documentation, refer to the following:

- *W@M Device Viewer* ([www.endress.com/deviceviewer](http://www.endress.com/deviceviewer)): Enter the serial number from nameplate
- *Endress+Hauser Operations App*: Enter the serial number from the nameplate or scan the 2D matrix code (QR code) on the nameplate

 Detailed list of the individual documents along with the documentation code  
→  266

### 1.3.1 Standard documentation

Document type	Purpose and content of the document
Technical Information	<b>Planning aid for your device</b> The document contains all the technical data on the device and provides an overview of the accessories and other products that can be ordered for the device.
Sensor Brief Operating Instructions	<b>Guides you quickly to the 1st measured value - Part 1</b> The Sensor Brief Operating Instructions are aimed at specialists with responsibility for installing the measuring device. <ul style="list-style-type: none"> <li>▪ Incoming acceptance and product identification</li> <li>▪ Storage and transport</li> <li>▪ Installation</li> </ul>
Transmitter Brief Operating Instructions	<b>Guides you quickly to the 1st measured value - Part 2</b> The Transmitter Brief Operating Instructions are aimed at specialists with responsibility for commissioning, configuring and parameterizing the measuring device (until the first measured value). <ul style="list-style-type: none"> <li>▪ Product description</li> <li>▪ Installation</li> <li>▪ Electrical connection</li> <li>▪ Operation options</li> <li>▪ System integration</li> <li>▪ Commissioning</li> <li>▪ Diagnostic information</li> </ul>
Description of Device Parameters	<b>Reference for your parameters</b> The document provides a detailed explanation of each individual parameter in the Expert operating menu. The description is aimed at those who work with the device over the entire life cycle and perform specific configurations.

### 1.3.2 Supplementary device-dependent documentation

Additional documents are supplied depending on the device version ordered: Always comply strictly with the instructions in the supplementary documentation. The supplementary documentation is an integral part of the device documentation.

## 1.4 Registered trademarks

**PROFIBUS®**

Registered trademark of the PROFIBUS User Organization, Karlsruhe, Germany

**TRI-CLAMP®**

Registered trademark of Ladish & Co., Inc., Kenosha, USA

## 2 Safety instructions

### 2.1 Requirements for the personnel

The personnel for installation, commissioning, diagnostics and maintenance must fulfill the following requirements:

- ▶ Trained, qualified specialists must have a relevant qualification for this specific function and task.
- ▶ Are authorized by the plant owner/operator.
- ▶ Are familiar with federal/national regulations.
- ▶ Before starting work, read and understand the instructions in the manual and supplementary documentation as well as the certificates (depending on the application).
- ▶ Follow instructions and comply with basic conditions.

The operating personnel must fulfill the following requirements:

- ▶ Are instructed and authorized according to the requirements of the task by the facility's owner-operator.
- ▶ Follow the instructions in this manual.

### 2.2 Designated use

#### Application and media

The measuring device described in this manual is intended only for the flow measurement of liquids.

Depending on the version ordered, the measuring device can also measure potentially explosive, flammable, poisonous and oxidizing media.

Measuring devices for use in hazardous areas, in hygienic applications or where there is an increased risk due to process pressure, are labeled accordingly on the nameplate.

To ensure that the measuring device remains in proper condition for the operation time:

- ▶ Keep within the specified pressure and temperature range.
- ▶ Only use the measuring device in full compliance with the data on the nameplate and the general conditions listed in the Operating Instructions and supplementary documentation.
- ▶ Based on the nameplate, check whether the ordered device is permitted for the intended use in the hazardous area (e.g. explosion protection, pressure vessel safety).
- ▶ Use the measuring device only for media to which the process-wetted materials are sufficiently resistant.
- ▶ If the ambient temperature of the measuring device is outside the atmospheric temperature, it is absolutely essential to comply with the relevant basic conditions as specified in the device documentation →  8.
- ▶ Protect the measuring device permanently against corrosion from environmental influences.

#### Incorrect use

Non-designated use can compromise safety. The manufacturer is not liable for damage caused by improper or non-designated use.

#### **WARNING**

#### **Danger of breakage due to corrosive or abrasive fluids and ambient conditions!**

- ▶ Verify the compatibility of the process fluid with the sensor material.
- ▶ Ensure the resistance of all fluid-wetted materials in the process.
- ▶ Keep within the specified pressure and temperature range.

**NOTICE****Verification for borderline cases:**

- ▶ For special fluids and fluids for cleaning, Endress+Hauser is glad to provide assistance in verifying the corrosion resistance of fluid-wetted materials, but does not accept any warranty or liability as minute changes in the temperature, concentration or level of contamination in the process can alter the corrosion resistance properties.

**Residual risks****⚠ WARNING**

**The electronics and the medium may cause the surfaces to heat up. This presents a burn hazard!**

- ▶ For elevated fluid temperatures, ensure protection against contact to prevent burns.

## 2.3 Workplace safety

For work on and with the device:

- ▶ Wear the required personal protective equipment according to federal/national regulations.

For welding work on the piping:

- ▶ Do not ground the welding unit via the measuring device.

If working on and with the device with wet hands:

- ▶ Due to the increased risk of electric shock, gloves must be worn.

## 2.4 Operational safety

Risk of injury.

- ▶ Operate the device in proper technical condition and fail-safe condition only.
- ▶ The operator is responsible for interference-free operation of the device.

**Conversions to the device**

Unauthorized modifications to the device are not permitted and can lead to unforeseeable dangers.

- ▶ If, despite this, modifications are required, consult with Endress+Hauser.

**Repair**

To ensure continued operational safety and reliability,

- ▶ Carry out repairs on the device only if they are expressly permitted.
- ▶ Observe federal/national regulations pertaining to repair of an electrical device.
- ▶ Use original spare parts and accessories from Endress+Hauser only.

## 2.5 Product safety

This measuring device is designed in accordance with good engineering practice to meet state-of-the-art safety requirements, has been tested, and left the factory in a condition in which it is safe to operate.

It meets general safety standards and legal requirements. It also complies with the EU directives listed in the device-specific EU Declaration of Conformity. Endress+Hauser confirms this by affixing the CE mark to the device.





## 2.6 IT security

Our warranty is valid only if the device is installed and used as described in the Operating Instructions. The device is equipped with security mechanisms to protect it against any inadvertent changes to the settings.

IT security measures, which provide additional protection for the device and associated data transfer, must be implemented by the operators themselves in line with their security standards.

## 2.7 Device-specific IT security

The device offers a range of specific functions to support protective measures on the operator's side. These functions can be configured by the user and guarantee greater in-operation safety if used correctly. An overview of the most important functions is provided in the following section.

Function/interface	Factory setting	Recommendation
Write protection via hardware write protection switch →  12	Not enabled.	On an individual basis following risk assessment.
Access code (also applies for Web server login or FieldCare connection) →  13	Not enabled (0000).	Assign a customized access code during commissioning.
WLAN (order option in display module)	Enabled.	On an individual basis following risk assessment.
WLAN security mode	Enabled (WPA2-PSK)	Do not change.
WLAN passphrase (password) →  13	Serial number	Assign an individual WLAN passphrase during commissioning.
WLAN mode	Access Point	On an individual basis following risk assessment.
Web server →  13	Enabled.	On an individual basis following risk assessment.
CDI-RJ45 service interface →  14	–	On an individual basis following risk assessment.

### 2.7.1 Protecting access via hardware write protection

Write access to the device parameters via the local display, Web browser or operating tool (e.g. FieldCare, DeviceCare) can be disabled via a write protection switch (DIP switch on the motherboard). When hardware write protection is enabled, only read access to the parameters is possible.

Hardware write protection is disabled when the device is delivered →  147.

### 2.7.2 Protecting access via a password

Different passwords are available to protect write access to the device parameters or access to the device via the WLAN interface.



- **User-specific access code**  
Protect write access to the device parameters via the local display, Web browser or operating tool (e.g. FieldCare, DeviceCare). Access authorization is clearly regulated through the use of a user-specific access code.
- **WLAN passphrase**  
The network key protects a connection between an operating unit (e.g. notebook or tablet) and the device via the WLAN interface which can be ordered as an option.
- **Infrastructure mode**  
When the device is operated in infrastructure mode, the WLAN passphrase corresponds to the WLAN passphrase configured on the operator side.

### User-specific access code

Write access to the device parameters via the local display, Web browser or operating tool (e.g. FieldCare, DeviceCare) can be protected by the modifiable, user-specific access code (→  146).

When the device is delivered, the device does not have an access code and is equivalent to 0000 (open).

### WLAN passphrase: Operation as WLAN access point

A connection between an operating unit (e.g. notebook or tablet) and the device via the WLAN interface (→  83), which can be ordered as an optional extra, is protected by the network key. The WLAN authentication of the network key complies with the IEEE 802.11 standard.

When the device is delivered, the network key is pre-defined depending on the device. It can be changed via the **WLAN settings** submenu in the **WLAN passphrase** parameter (→  140).

### Infrastructure mode

A connection between the device and WLAN access point is protected by means of an SSID and passphrase on the system side. Please contact the relevant system administrator for access.

### General notes on the use of passwords

- The access code and network key supplied with the device should be changed during commissioning.
- Follow the general rules for generating a secure password when defining and managing the access code or network key.
- The user is responsible for the management and careful handling of the access code and network key.
- For information on configuring the access code or on what to do if you lose the password, see the "Write protection via access code" section →  146

## 2.7.3 Access via Web server

The device can be operated and configured via a Web browser with the integrated Web server (→  75). The connection is via the service interface (CDI-RJ45) or the WLAN interface.

The Web server is enabled when the device is delivered. The Web server can be disabled if necessary (e.g. after commissioning) via the **Web server functionality** parameter.

The device and status information can be hidden on the login page. This prevents unauthorized access to the information.



For detailed information on device parameters, see:  
The "Description of Device Parameters" document →  267.

### 2.7.4 Access via service interface (CDI-RJ45)

The device can be connected to a network via the service interface (CDI-RJ45). Device-specific functions guarantee the secure operation of the device in a network.

The use of relevant industrial standards and guidelines that have been defined by national and international safety committees, such as IEC/ISA62443 or the IEEE, is recommended. This includes organizational security measures such as the assignment of access authorization as well as technical measures such as network segmentation.

 Transmitters with an Ex de approval may not be connected via the service interface (CDI-RJ45)!

Order code for "Approval transmitter + sensor", options (Ex de): BA, BB, C1, C2, GA, GB, MA, MB, NA, NB

## 3 Product description

The measuring system consists of a transmitter and a sensor. The transmitter and sensor are mounted in physically separate locations. They are interconnected by connecting cables.

### 3.1 Product design

Two versions of the transmitter are available.

#### 3.1.1 Proline 500 – digital

Signal transmission: digital

Order code for "Integrated ISEM electronics", option **A** "Sensor"

For use in applications not required to meet special requirements due to ambient or operating conditions.

As the electronics are located in the sensor, the device is ideal:  
For simple transmitter replacement.

- A standard cable can be used as the connecting cable.
- Not sensitive to external EMC interference.

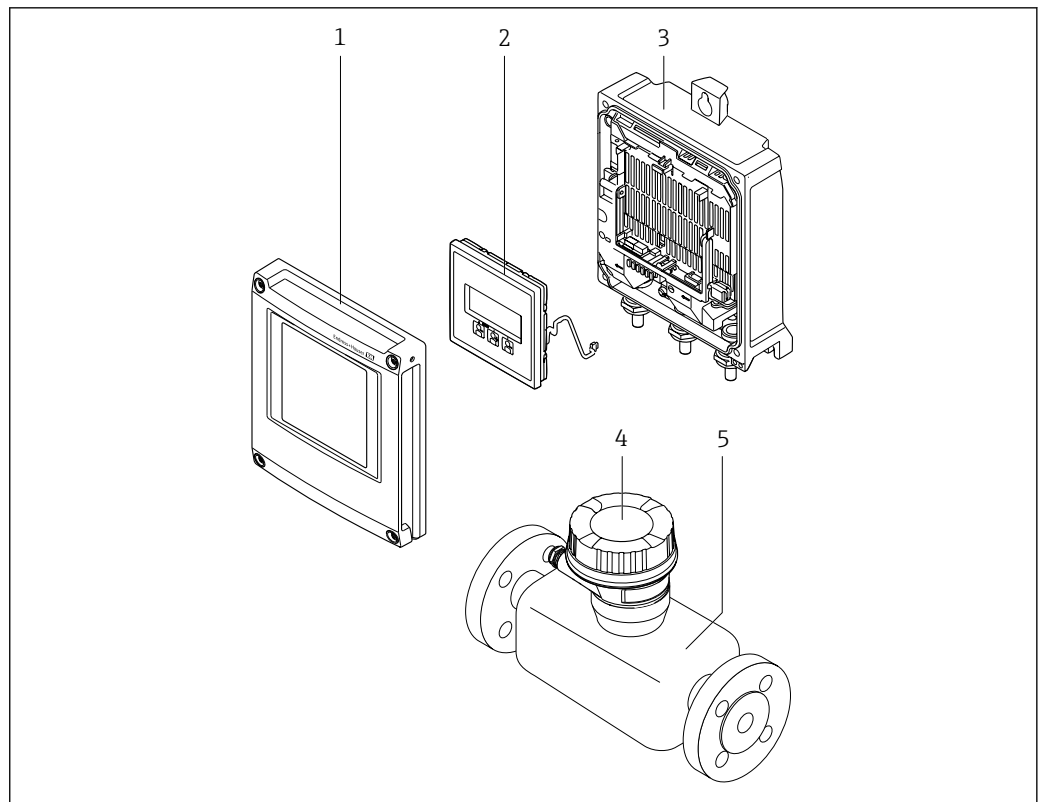

A0029593

#### 1 Important components of a measuring device

- 1 Electronics compartment cover
- 2 Display module
- 3 Transmitter housing
- 4 Sensor connection housing with integrated ISEM electronics: connecting cable connection
- 5 Sensor

### 3.1.2 Proline 500

Signal transmission: analog

Order code for "Integrated ISEM electronics", option **B** "Transmitter"

For use in applications required to meet special requirements due to ambient or operating conditions.

As the electronics are located in the transmitter, the device is ideal in the event of:

- Strong vibrations at the sensor.
- Sensor operation in underground installations.
- Permanent sensor immersion in water.

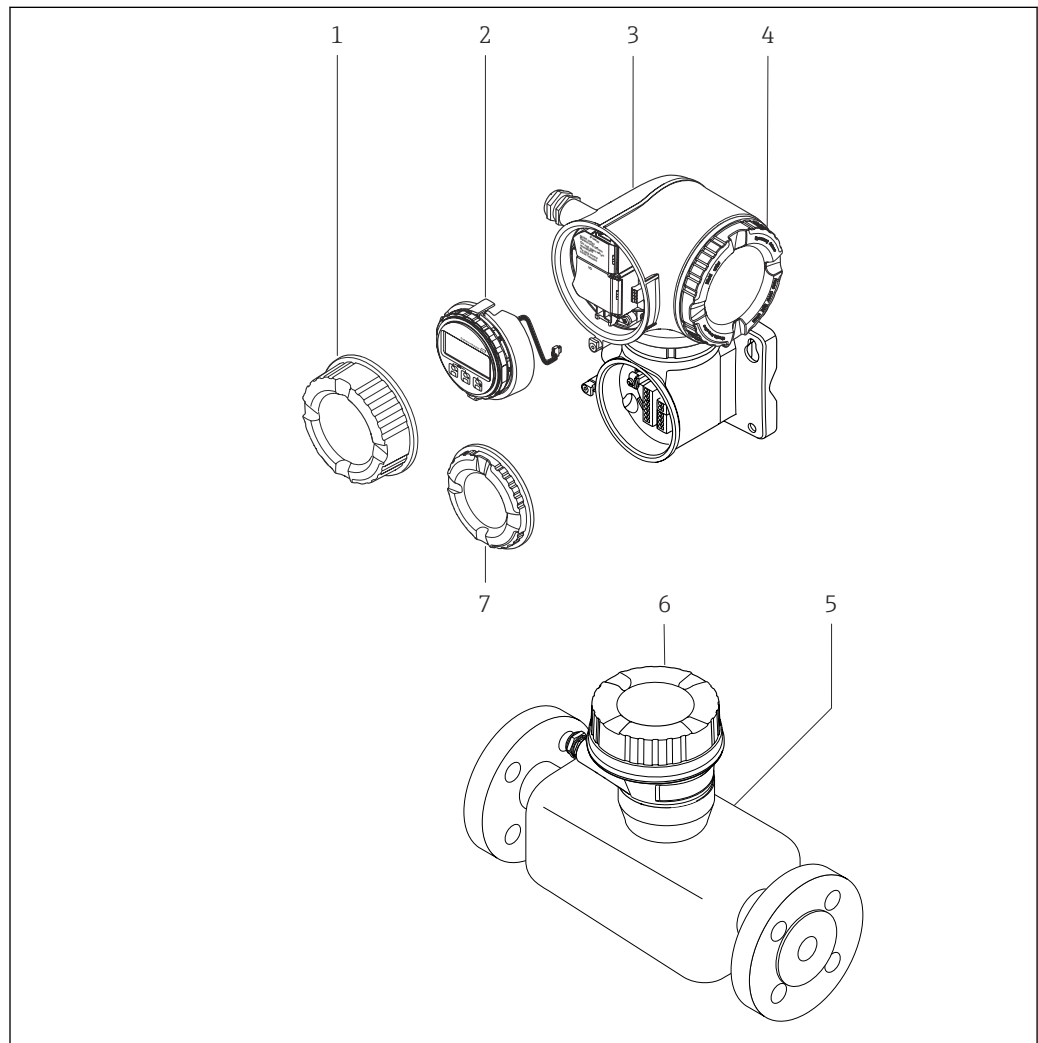

A0029589

#### 2 Important components of a measuring device

- 1 Connection compartment cover
- 2 Display module
- 3 Transmitter housing with integrated ISEM electronics
- 4 Electronics compartment cover
- 5 Sensor
- 6 Sensor connection housing: connecting cable connection
- 7 Connection compartment cover: connecting cable connection

## 4 Incoming acceptance and product identification

### 4.1 Incoming acceptance

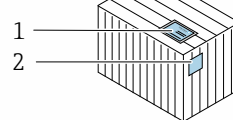
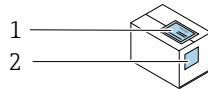

Are the order codes on the delivery note (1) and the product sticker (2) identical?

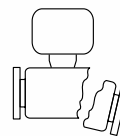
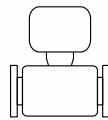
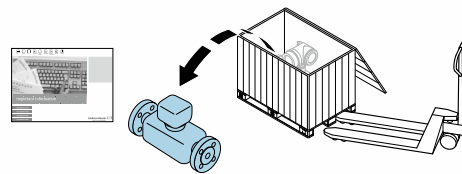

Are the goods undamaged?

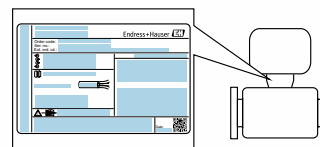

Do the nameplate data match the ordering information on the delivery note?



Is the envelope present with accompanying documents?



- If one of the conditions is not satisfied, contact your Endress+Hauser Sales Center.
- Depending on the device version, the CD-ROM might not be part of the delivery! The Technical Documentation is available via the Internet or via the *Endress+Hauser Operations App*, see the "Product identification" section → 18.

### 4.2 Product identification

The following options are available for identification of the device:

- Nameplate specifications
- Order code with breakdown of the device features on the delivery note
- Enter serial numbers from nameplates in the *W@M Device Viewer* ([www.endress.com/deviceviewer](http://www.endress.com/deviceviewer)): All information about the device is displayed.
- Enter the serial number from nameplates in the *Endress+Hauser Operations App* or scan the 2-D matrix code (QR code) on the nameplate using the *Endress+Hauser Operations App*: All information about the device is displayed.

For an overview of the scope of the associated Technical Documentation, refer to the following:

- The "Additional standard documentation on the device" → 8 and "Supplementary device-dependent documentation" → 8 sections
- The *W@M Device Viewer*: enter the serial number from the nameplate ([www.endress.com/deviceviewer](http://www.endress.com/deviceviewer))
- The *Endress+Hauser Operations App*: Enter the serial number from the nameplate or scan the 2-D matrix code (QR code) on the nameplate.

### 4.2.1 Transmitter nameplate

#### Proline 500 – digital

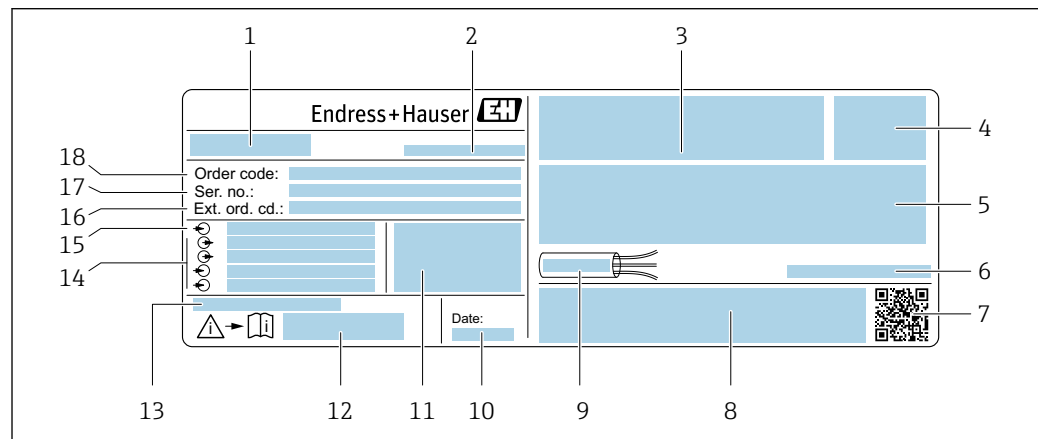

A0029194

3 Example of a transmitter nameplate

- 1 Name of the transmitter
- 2 Manufacturing location
- 3 Space for approvals: use in hazardous areas
- 4 Degree of protection
- 5 Electrical connection data: available inputs and outputs
- 6 Permitted ambient temperature ( $T_a$ )
- 7 2-D matrix code
- 8 Space for approvals and certificates: e.g. CE mark, C-Tick
- 9 Permitted temperature range for cable
- 10 Manufacturing date: year-month
- 11 Firmware version (FW) and device revision (Dev.Rev.) from the factory
- 12 Document number of safety-related supplementary documentation
- 13 Space for additional information in the case of special products
- 14 Available inputs and outputs, supply voltage
- 15 Electrical connection data: supply voltage
- 16 Extended order code (ext. ord. cd.)
- 17 Serial number (ser. no.)
- 18 Order code

**Proline 500**

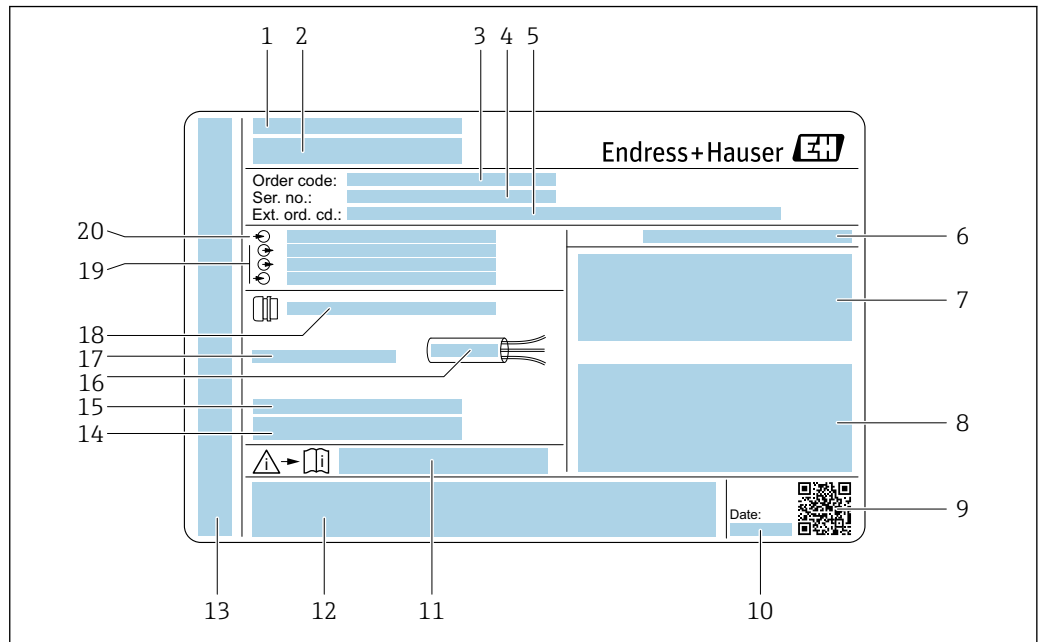

A0029192

**4** Example of a transmitter nameplate

- 1 Manufacturing location
- 2 Name of the transmitter
- 3 Order code
- 4 Serial number (ser. no.)
- 5 Extended order code (ext. ord. cd.)
- 6 Degree of protection
- 7 Space for approvals: use in hazardous areas
- 8 Electrical connection data: available inputs and outputs
- 9 2-D matrix code
- 10 Manufacturing date: year-month
- 11 Document number of safety-related supplementary documentation
- 12 Space for approvals and certificates: e.g. CE mark, C-Tick
- 13 Space for degree of protection of connection and electronics compartment when used in hazardous areas
- 14 Firmware version (FW) and device revision (Dev.Rev.) from the factory
- 15 Space for additional information in the case of special products
- 16 Permitted temperature range for cable
- 17 Permitted ambient temperature ( $T_a$ )
- 18 Information on cable gland
- 19 Available inputs and outputs, supply voltage
- 20 Electrical connection data: supply voltage

## 4.2.2 Sensor nameplate

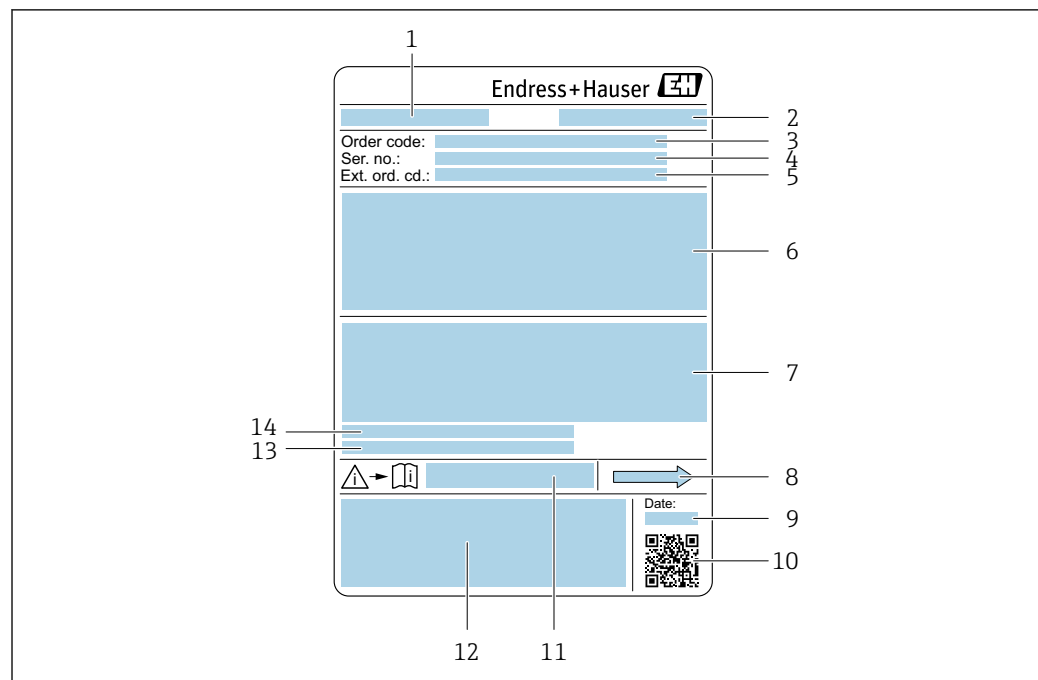

A0029199

5 Example of a sensor nameplate

- 1 Name of the sensor
- 2 Manufacturing location
- 3 Order code
- 4 Serial number (ser. no.)
- 5 Extended order code (Ext. ord. cd.)
- 6 Nominal diameter of the sensor; flange nominal diameter/nominal pressure; sensor test pressure; medium temperature range; material of measuring tube and manifold; sensor-specific information: e.g. pressure range of sensor housing, wide-range density specification (special density calibration)
- 7 Approval information for explosion protection, Pressure Equipment Directive and degree of protection
- 8 Flow direction
- 9 Manufacturing date: year-month
- 10 2-D matrix code
- 11 Document number of safety-related supplementary documentation
- 12 CE mark, C-Tick
- 13 Surface roughness
- 14 Permitted ambient temperature ( $T_a$ )

### Order code



The measuring device is reordered using the order code.

#### Extended order code

- The device type (product root) and basic specifications (mandatory features) are always listed.
- Of the optional specifications (optional features), only the safety and approval-related specifications are listed (e.g. LA). If other optional specifications are also ordered, these are indicated collectively using the # placeholder symbol (e.g. #LA#).
- If the ordered optional specifications do not include any safety and approval-related specifications, they are indicated by the + placeholder symbol (e.g. XXXXXX-ABCDE+).



### 4.2.3 Symbols on measuring device

Symbol	Meaning
	<b>WARNING!</b> This symbol alerts you to a dangerous situation. Failure to avoid this situation can result in serious or fatal injury.
	<b>Reference to documentation</b> Refers to the corresponding device documentation.
	<b>Protective ground connection</b> A terminal which must be connected to ground prior to establishing any other connections.

## 5 Storage and transport

### 5.1 Storage conditions

Observe the following notes for storage:

- ▶ Store in the original packaging to ensure protection from shock.
- ▶ Do not remove protective covers or protective caps installed on process connections. They prevent mechanical damage to the sealing surfaces and contamination in the measuring tube.
- ▶ Protect from direct sunlight to avoid unacceptably high surface temperatures.
- ▶ Store in a dry and dust-free place.
- ▶ Do not store outdoors.

Storage temperature →  252

### 5.2 Transporting the product

Transport the measuring device to the measuring point in the original packaging.

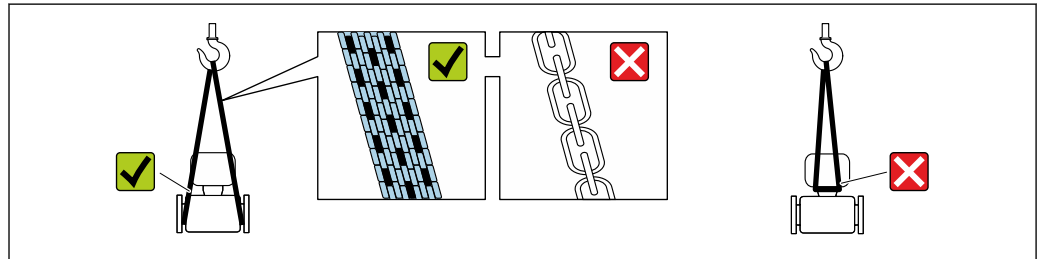

A0029252

-  Do not remove protective covers or caps installed on process connections. They prevent mechanical damage to the sealing surfaces and contamination in the measuring tube.

#### 5.2.1 Measuring devices without lifting lugs

##### WARNING

**Center of gravity of the measuring device is higher than the suspension points of the webbing slings.**

Risk of injury if the measuring device slips.

- ▶ Secure the measuring device against slipping or turning.
- ▶ Observe the weight specified on the packaging (stick-on label).

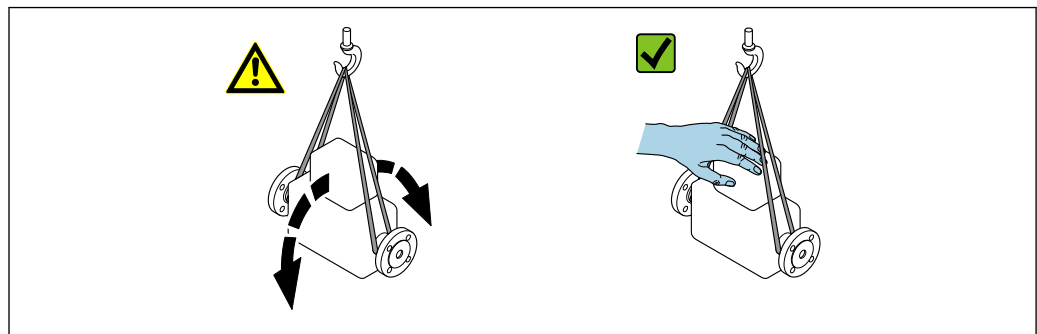

A0029214

## 5.2.2 Measuring devices with lifting lugs

### ⚠ CAUTION

#### Special transportation instructions for devices with lifting lugs

- ▶ Only use the lifting lugs fitted on the device or flanges to transport the device.
- ▶ The device must always be secured at two lifting lugs at least.

## 5.2.3 Transporting with a fork lift

If transporting in wood crates, the floor structure enables the crates to be lifted lengthwise or at both sides using a forklift.

## 5.3 Packaging disposal

All packaging materials are environmentally friendly and 100 % recyclable:

- Outer packaging of device
  - Polymer stretch wrap that complies with EU Directive 2002/95/EC (RoHS)
- Packaging
  - Wooden crate treated in accordance with ISPM 15 standard, confirmed by IPPC logo
  - Cardboard box in accordance with European packaging guideline 94/62EC, recyclability confirmed by Resy symbol
- Carrying and securing materials
  - Disposable plastic pallet
  - Plastic straps
  - Plastic adhesive strips
- Filler material
  - Paper pads

## 6 Installation

### 6.1 Installation conditions

#### 6.1.1 Mounting position

##### Mounting location

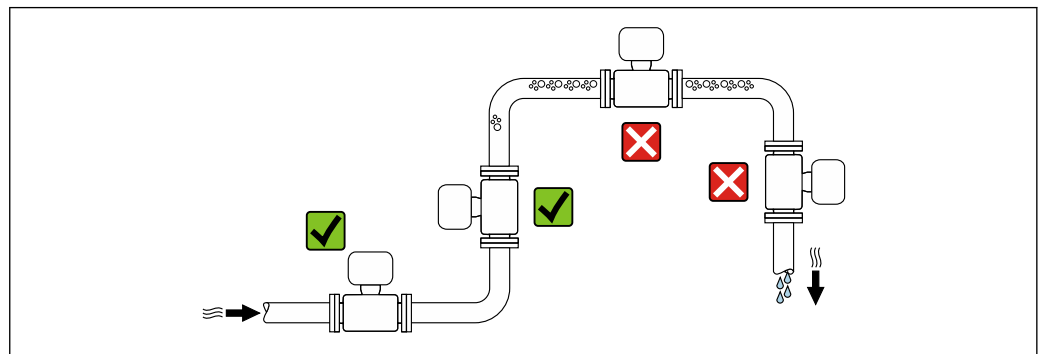

A0028772

To prevent measuring errors arising from accumulation of gas bubbles in the measuring tube, avoid the following mounting locations in the pipe:

- Highest point of a pipeline.
- Directly upstream of a free pipe outlet in a down pipe.

*Installation in down pipes*

However, the following installation suggestion allows for installation in an open vertical pipeline. Pipe restrictions or the use of an orifice with a smaller cross-section than the nominal diameter prevent the sensor running empty while measurement is in progress.

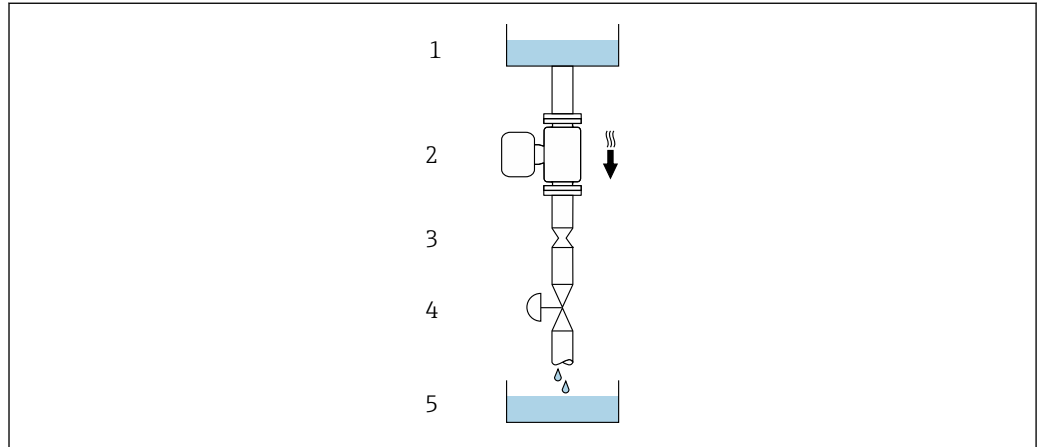

A0028773

6 Installation in a down pipe (e.g. for batching applications)







- 1 Supply tank
- 2 Sensor
- 3 Orifice plate, pipe restriction
- 4 Valve
- 5 Batching tank

DN		Ø orifice plate, pipe restriction	
[mm]	[in]	[mm]	[in]
8	3/8	6	0.24
15	1/2	10	0.40
25	1	14	0.55
40	1 1/2	22	0.87
50	2	28	1.10

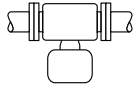
**Orientation**

The direction of the arrow on the sensor nameplate helps you to install the sensor according to the flow direction (direction of medium flow through the piping).

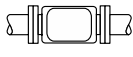
Orientation		Recommendation
<b>A</b>	Vertical orientation	 <small>A0015591</small> <input checked="" type="checkbox"/> <input checked="" type="checkbox"/> <sup>1)</sup>
<b>B</b>	Horizontal orientation, transmitter at top	 <small>A0015589</small> <input checked="" type="checkbox"/> <input checked="" type="checkbox"/> <sup>2)</sup> Exceptions: →  7,  25

Orientation		Recommendation
C	Horizontal orientation, transmitter at bottom	 <small>A0015590</small>   <sup>3)</sup> Exceptions: →  7,  25
D	Horizontal orientation, transmitter at side	 <small>A0015592</small>  

- 1) This orientation is recommended to ensure self-draining.
- 2) Applications with low process temperatures may decrease the ambient temperature. To maintain the minimum ambient temperature for the transmitter, this orientation is recommended.
- 3) Applications with high process temperatures may increase the ambient temperature. To maintain the maximum ambient temperature for the transmitter, this orientation is recommended.

If a sensor is installed horizontally with a curved measuring tube, match the position of the sensor to the fluid properties.

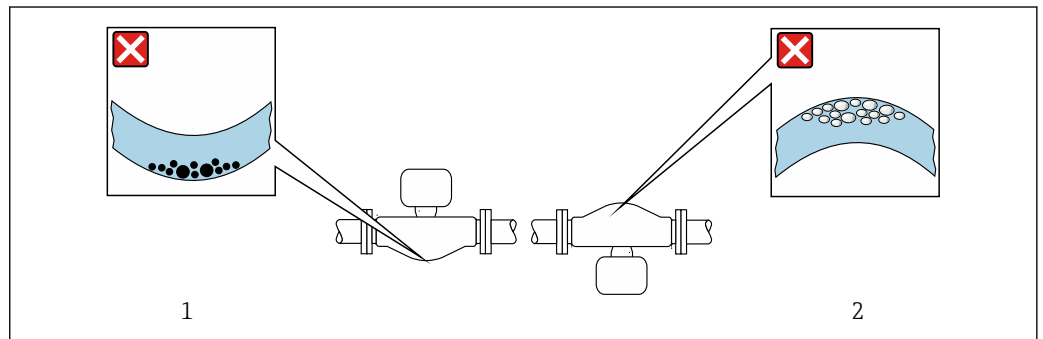

 7 Orientation of sensor with curved measuring tube

- 1 Avoid this orientation for fluids with entrained solids: Risk of solids accumulating.
- 2 Avoid this orientation for outgassing fluids: Risk of gas accumulating.

### Inlet and outlet runs

No special precautions need to be taken for fittings that create turbulence, such as valves, elbows or T-pieces, as long as no cavitation occurs →  26.

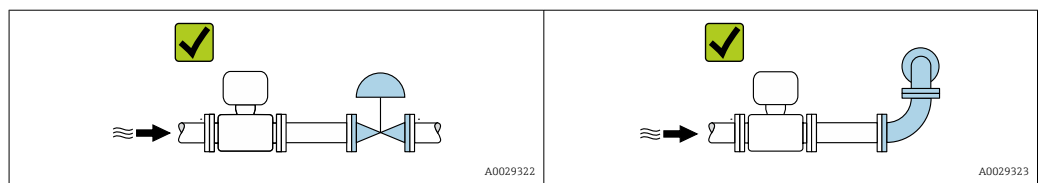

### Installation dimensions

 For the dimensions and installation lengths of the device, see the "Technical Information" document, "Mechanical construction" section .

## 6.1.2 Environmental and process requirements

### Ambient temperature range

<b>Measuring device</b>	<ul style="list-style-type: none"> <li>▪ -40 to +60 °C (-40 to +140 °F)</li> <li>▪ Order code for "Test, certificate", option JP: -50 to +60 °C (-58 to +140 °F)</li> </ul>
<b>Readability of the local display</b>	<p>-20 to +60 °C (-4 to +140 °F)</p> <p>The readability of the display may be impaired at temperatures outside the temperature range.</p>

 Dependency of ambient temperature on medium temperature →  254

- ▶ If operating outdoors:  
Avoid direct sunlight, particularly in warm climatic regions.

 You can order a weather protection cover from Endress+Hauser. →  236.

### System pressure

It is important that cavitation does not occur, or that gases entrained in the liquids do not outgas.

Cavitation is caused if the pressure drops below the vapor pressure:

- In liquids that have a low boiling point (e.g. hydrocarbons, solvents, liquefied gases)
  - In suction lines
- ▶ Ensure the system pressure is sufficiently high to prevent cavitation and outgassing.

For this reason, the following mounting locations are recommended:

- At the lowest point in a vertical pipe
- Downstream from pumps (no danger of vacuum)

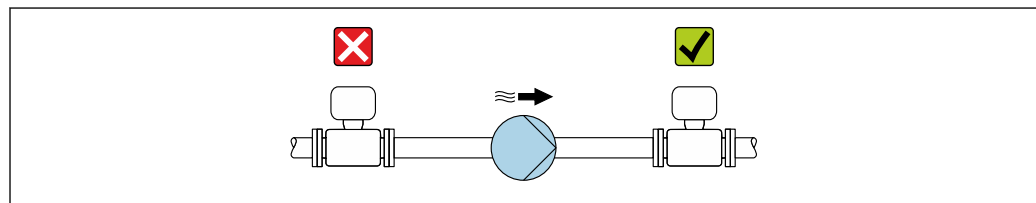

A0028771

### Thermal insulation

In the case of some fluids, it is important to keep the heat radiated from the sensor to the transmitter to a low level. A wide range of materials can be used for the required insulation.

The following device versions are recommended for versions with thermal insulation:

Version with extended neck for insulation:

Order code for "Sensor option", option CG with an extended neck length of 105 mm (4.13 in).

**NOTICE****Electronics overheating on account of thermal insulation!**

- ▶ Recommended orientation: horizontal orientation, sensor connection housing pointing downwards.
- ▶ Do not insulate the sensor connection housing.
- ▶ Maximum permissible temperature at the lower end of the sensor connection housing: 80 °C (176 °F)
- ▶ Thermal insulation with extended neck free: We recommend that you do not insulate the extended neck in order to ensure optimum dissipation of heat.

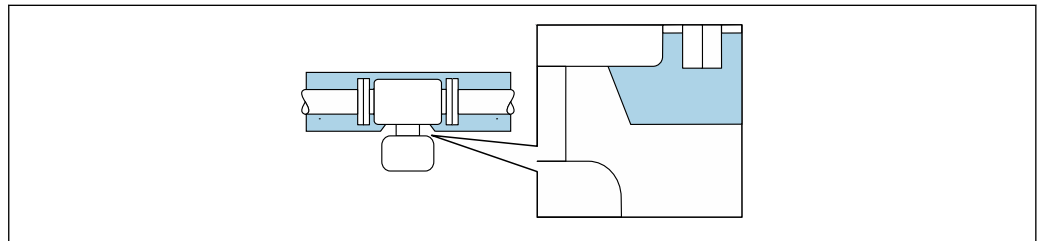

A0034391

 8 Thermal insulation with extended neck free

**Heating****NOTICE****Electronics can overheat due to elevated ambient temperature!**

- ▶ Observe maximum permitted ambient temperature for the transmitter .
- ▶ Depending on the fluid temperature, take the device orientation requirements into account .

**NOTICE****Danger of overheating when heating**

- ▶ Ensure that the temperature at the lower end of the transmitter housing does not exceed 80 °C (176 °F).
- ▶ Ensure that sufficient convection takes place at the transmitter neck.
- ▶ Ensure that a sufficiently large area of the transmitter neck remains exposed. The uncovered part serves as a radiator and protects the electronics from overheating and excessive cooling.
- ▶ When using in potentially explosive atmospheres, observe the information in the device-specific Ex documentation. For detailed information on the temperature tables, see the separate document entitled "Safety Instructions" (XA) for the device.

*Heating options*

If a fluid requires that no heat loss should occur at the sensor, users can avail of the following heating options:

- Electrical heating, e.g. with electric band heaters
- Via pipes carrying hot water or steam
- Via heating jackets

**Vibrations**

The high oscillation frequency of the measuring tubes ensures that the correct operation of the measuring system is not influenced by plant vibrations.

**6.1.3 Special mounting instructions****Drainability**

The measuring tubes can be completely drained and protected against solids build-up in vertical orientation.

### Sanitary compatibility

**i** When installing in hygienic applications, please refer to the information in the "Certificates and approvals/hygienic compatibility" section → 263

### Securing with mounting clamp in the case of hygiene connections

It is not necessary to provide additional support for the sensor for operational performance purposes. If, however, additional support is required for installation purposes, the following dimensions must be observed.

Use mounting clamp with lining between clamp and measuring instrument.

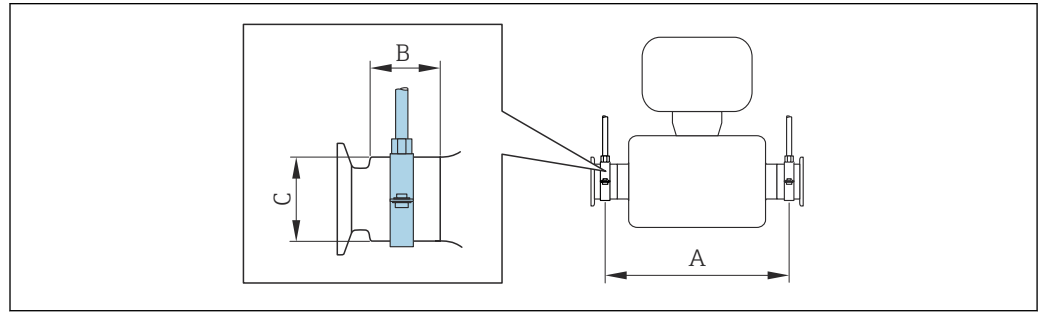

DN		A		B		C	
[mm]	[in]	[mm]	[in]	[mm]	[in]	[mm]	[in]
8	$\frac{3}{8}$	298	11.73	33	1.3	28	1.1
15	$\frac{1}{2}$	402	15.83	33	1.3	28	1.1
25	1	542	21.34	33	1.3	38	1.5
40	1 $\frac{1}{2}$	658	25.91	36.5	1.44	56	2.2
50	2	772	30.39	44.1	1.74	75	2.95

### Zero point adjustment

All measuring devices are calibrated in accordance with state-of-the-art technology. Calibration takes place under reference conditions → 248. Therefore, a zero point adjustment in the field is generally not required.

Experience shows that zero point adjustment is advisable only in special cases:

- To achieve maximum measuring accuracy even with low flow rates.
- Under extreme process or operating conditions (e.g. very high process temperatures or very high-viscosity fluids).



### Protective cover

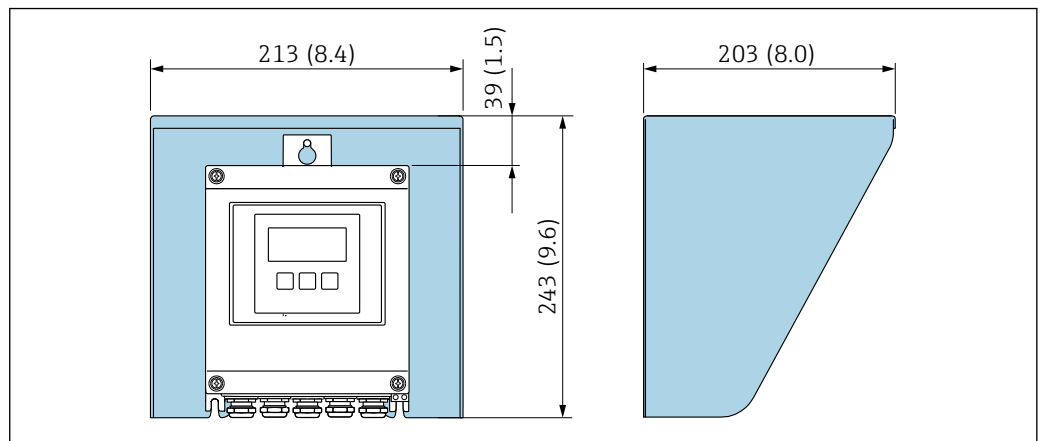

9 Protective cover for Proline 500 – digital; engineering unit mm (in)

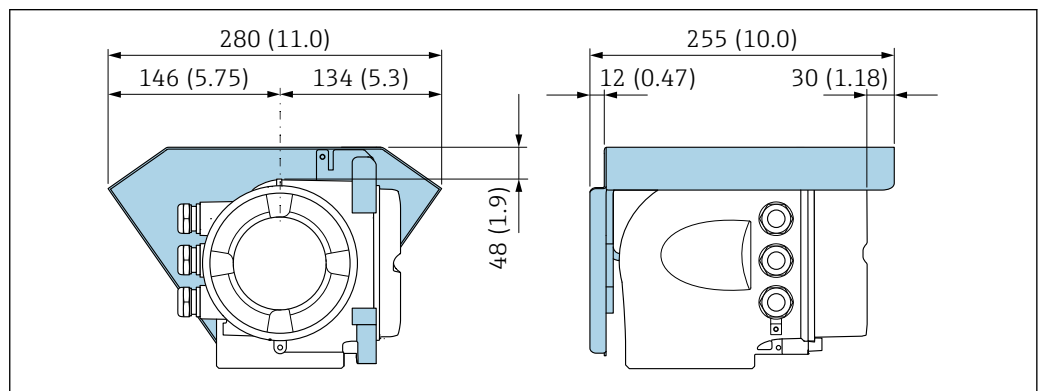

10 Protective cover for Proline 500; engineering unit mm (in)

## 6.2 Mounting the measuring device

### 6.2.1 Required tools

#### For transmitter

For mounting on a post:

- Proline 500 – digital transmitter
  - Open-ended wrench AF 10
  - Torx screwdriver TX 25
- Proline 500 transmitter
  - Open-ended wrench AF 13

For wall mounting:

Drill with drill bit  $\varnothing$  6.0 mm

#### For sensor

For flanges and other process connections: Corresponding mounting tools

### 6.2.2 Preparing the measuring device

1. Remove all remaining transport packaging.
2. Remove any protective covers or protective caps present from the sensor.

3. Remove stick-on label on the electronics compartment cover.

### 6.2.3 Mounting the measuring device

#### **⚠ WARNING**

#### **Danger due to improper process sealing!**

- ▶ Ensure that the inside diameters of the gaskets are greater than or equal to that of the process connections and piping.
- ▶ Ensure that the seals are clean and undamaged.
- ▶ Secure the seals correctly.

1. Ensure that the direction of the arrow on the nameplate of the sensor matches the flow direction of the fluid.
2. Install the measuring device or turn the transmitter housing so that the cable entries do not point upwards.

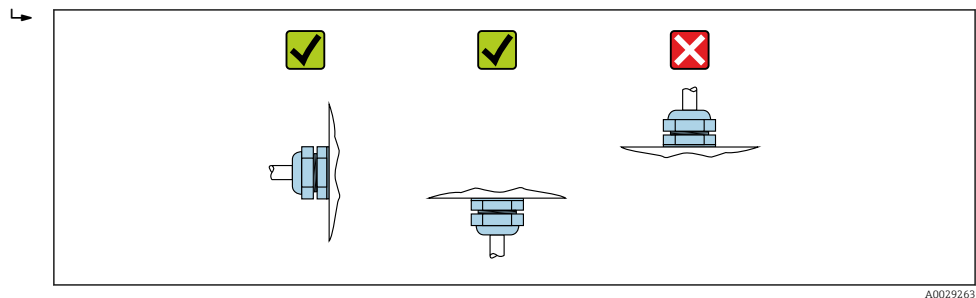

A0029263

### 6.2.4 Mounting the transmitter housing: Proline 500 – digital

#### **⚠ CAUTION**

#### **Ambient temperature too high!**

Danger of electronics overheating and housing deformation.

- ▶ Do not exceed the permitted maximum ambient temperature .
- ▶ If operating outdoors: Avoid direct sunlight and exposure to weathering, particularly in warm climatic regions.

#### **⚠ CAUTION**

#### **Excessive force can damage the housing!**

- ▶ Avoid excessive mechanical stress.

The transmitter can be mounted in the following ways:

- Post mounting
- Wall mounting

#### **Post mounting**

#### **⚠ WARNING**

#### **Excessive tightening torque applied to the fixing screws!**

Risk of damaging the plastic transmitter.

- ▶ Tighten the fixing screws as per the tightening torque: 2 Nm (1.5 lbf ft)

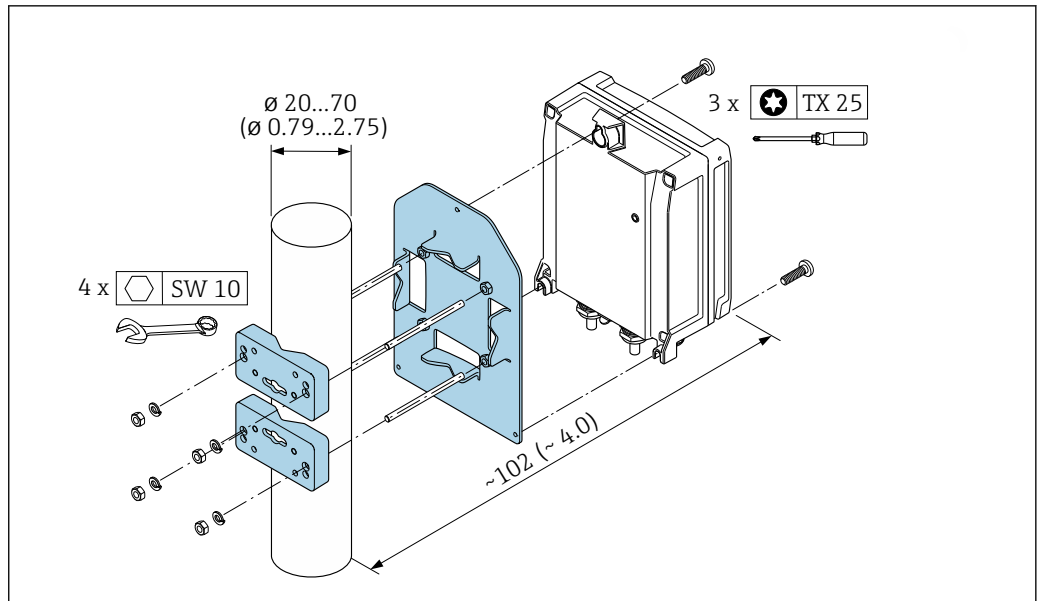

A0029051

11 Engineering unit mm (in)

### Wall mounting

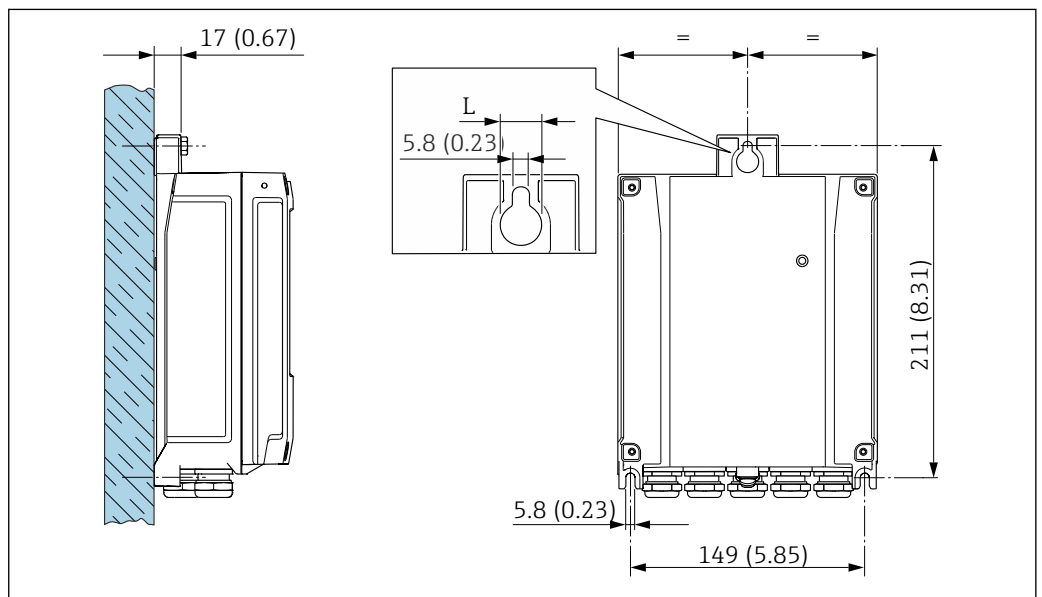

A0029054

12 Engineering unit mm (in)

L Depends on order code for "Transmitter housing"

Order code for "Transmitter housing"

- Option A, aluminum coated: L = 14 mm (0.55 in)
- Option D, polycarbonate: L = 13 mm (0.51 in)

1. Drill the holes.
2. Insert wall plugs into the drilled holes.
3. Screw in the securing screws slightly at first.
4. Fit the transmitter housing over the securing screws and mount in place.
5. Tighten the securing screws.

## 6.2.5 Mounting the transmitter housing: Proline 500

### ⚠ CAUTION

#### Ambient temperature too high!

Danger of electronics overheating and housing deformation.

- ▶ Do not exceed the permitted maximum ambient temperature .
- ▶ If operating outdoors: Avoid direct sunlight and exposure to weathering, particularly in warm climatic regions.

### ⚠ CAUTION

#### Excessive force can damage the housing!

- ▶ Avoid excessive mechanical stress.

The transmitter can be mounted in the following ways:

- Post mounting
- Wall mounting

#### Wall mounting

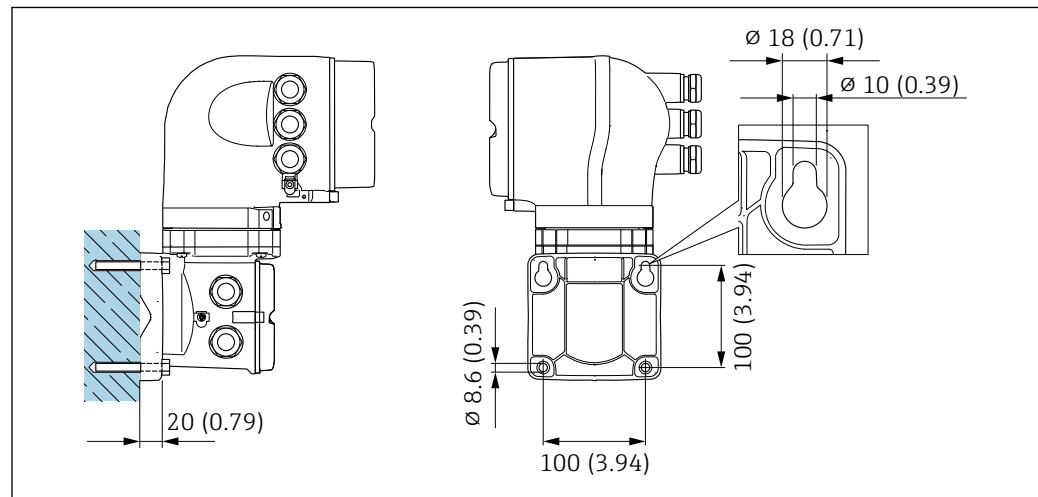

13 Engineering unit mm (in)

1. Drill the holes.
2. Insert wall plugs into the drilled holes.
3. Screw in the securing screws slightly at first.
4. Fit the transmitter housing over the securing screws and mount in place.
5. Tighten the securing screws.

### Post mounting

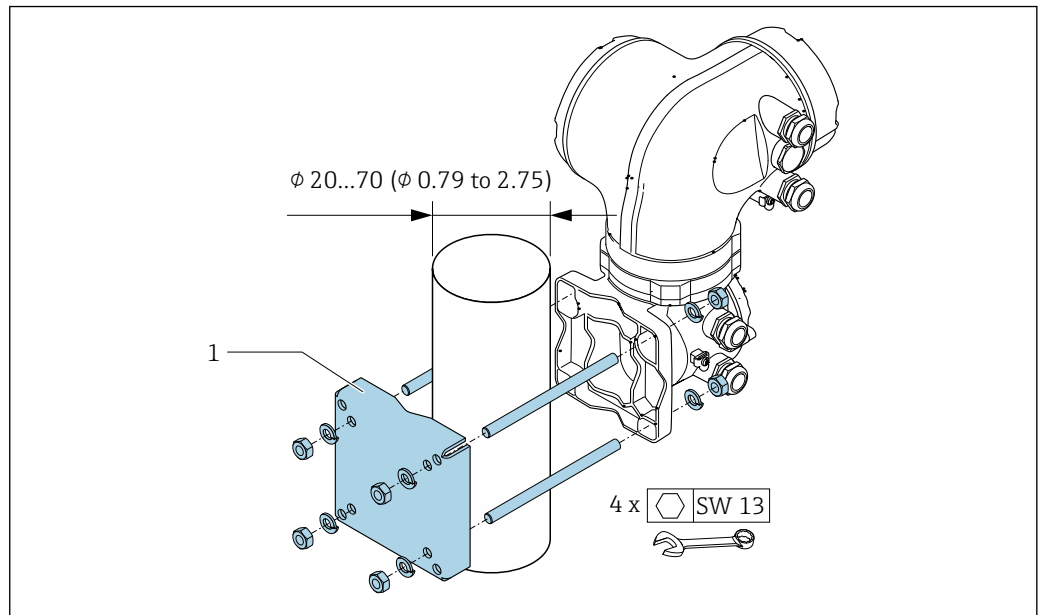

A0029057

14 Engineering unit mm (in)

### 6.2.6 Turning the transmitter housing: Proline 500

To provide easier access to the connection compartment or display module, the transmitter housing can be turned.

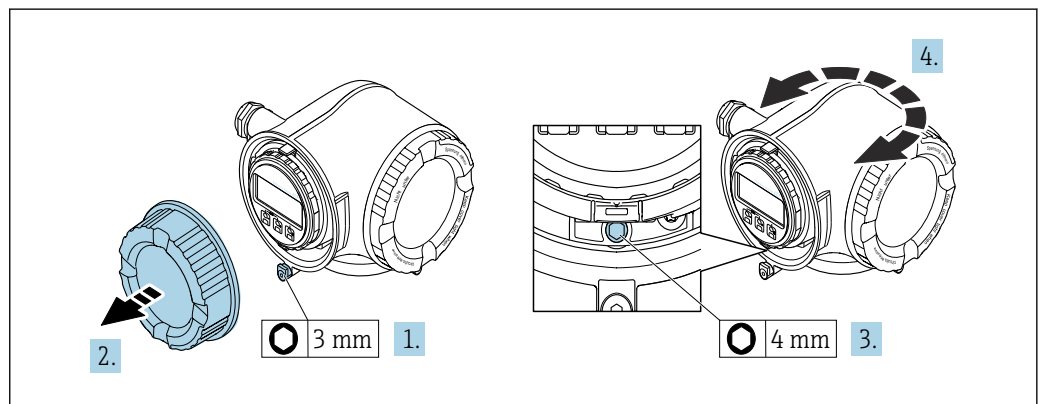

A0029993

1. Depending on the device version: Loosen the securing clamp of the connection compartment cover.
2. Unscrew the connection compartment cover.
3. Release the fixing screw.
4. Turn the housing to the desired position.
5. Firmly tighten the securing screw.
6. Screw on the connection compartment cover.
7. Depending on the device version: Attach the securing clamp of the connection compartment cover.

### 6.2.7 Turning the display module: Proline 500

The display module can be turned to optimize display readability and operability.

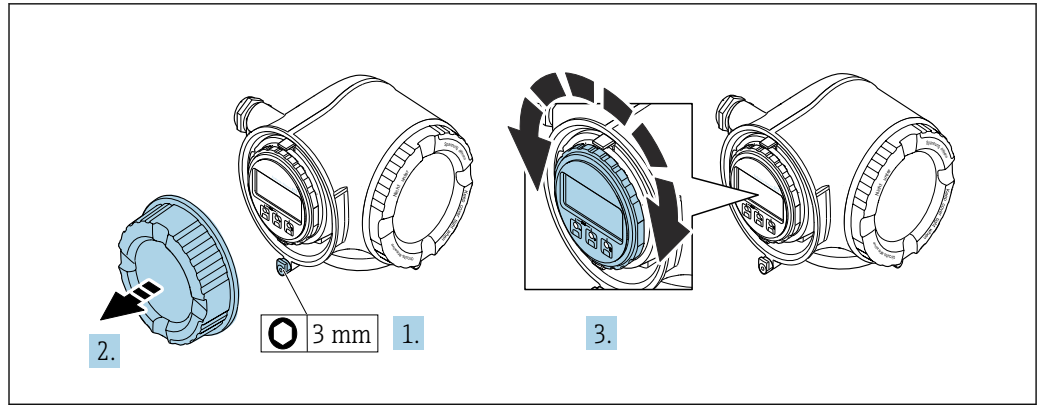

1. Depending on the device version: Loosen the securing clamp of the connection compartment cover.
2. Unscrew the connection compartment cover.
3. Turn the display module to the desired position: max.  $8 \times 45^\circ$  in each direction.
4. Screw on the connection compartment cover.
5. Depending on the device version: Attach the securing clamp of the connection compartment cover.

### 6.3 Post-installation check

Is the device undamaged (visual inspection)?	<input type="checkbox"/>
Does the measuring device conform to the measuring point specifications? For example: <ul style="list-style-type: none"> <li>▪ Process temperature → 254</li> <li>▪ Process pressure (refer to the section on "Pressure-temperature ratings" in the "Technical Information" document)</li> <li>▪ Ambient temperature</li> <li>▪ Measuring range</li> </ul>	<input type="checkbox"/>
Has the correct orientation for the sensor been selected ? <ul style="list-style-type: none"> <li>▪ According to sensor type</li> <li>▪ According to medium temperature</li> <li>▪ According to medium properties (outgassing, with entrained solids)</li> </ul>	<input type="checkbox"/>
Does the arrow on the sensor nameplate match the direction of flow of the fluid through the piping → 24?	<input type="checkbox"/>
Are the measuring point identification and labeling correct (visual inspection)?	<input type="checkbox"/>
Is the device adequately protected from precipitation and direct sunlight?	<input type="checkbox"/>
Are the securing screw and securing clamp tightened securely?	<input type="checkbox"/>

## 7 Electrical connection

### NOTICE

The measuring device does not have an internal circuit breaker.

- ▶ For this reason, assign the measuring device a switch or power-circuit breaker so that the power supply line can be easily disconnected from the mains.
- ▶ Although the measuring device is equipped with a fuse, additional overcurrent protection (maximum 10 A) should be integrated into the system installation.

### 7.1 Connection conditions

#### 7.1.1 Required tools

- For cable entries: Use corresponding tools
- For securing clamp: Allen key 3 mm
- Wire stripper
- When using stranded cables: crimper for wire end ferrule
- For removing cables from terminal: Flat blade screwdriver  $\leq 3$  mm (0.12 in)

#### 7.1.2 Requirements for connecting cable

The connecting cables provided by the customer must fulfill the following requirements.

##### Electrical safety

In accordance with applicable federal/national regulations.

##### Protective ground cable

Cable  $\geq 2.08$  mm<sup>2</sup> (14 AWG)

The grounding impedance must be less than 1  $\Omega$ .

##### Permitted temperature range

- The installation guidelines that apply in the country of installation must be observed.
- The cables must be suitable for the minimum and maximum temperatures to be expected.

##### Power supply cable

Standard installation cable is sufficient.

##### Signal cable

*PROFIBUS DP*

The IEC 61158 standard specifies two types of cable (A and B) for the bus line which can be used for every transmission rate. Cable type A is recommended.

Cable type	A
Characteristic impedance	135 to 165 $\Omega$ at a measuring frequency of 3 to 20 MHz
Cable capacitance	< 30 pF/m
Wire cross-section	> 0.34 mm <sup>2</sup> (22 AWG)
Cable type	Twisted pairs
Loop resistance	$\leq 110$ $\Omega$ /km

<b>Signal damping</b>	Max. 9 dB over the entire length of the cable cross-section
<b>Shield</b>	Copper braided shielding or braided shielding with foil shield. When grounding the cable shield, observe the grounding concept of the plant.



For further information on planning and installing PROFIBUS networks see:

Operating Instructions "PROFIBUS DP/PA: Guidelines for planning and commissioning" (BA00034S)

*Current output 0/4 to 20 mA*

Standard installation cable is sufficient.

*Pulse/frequency/switch output*

Standard installation cable is sufficient.

*Relay output*

Standard installation cable is sufficient.

*Current input 0/4 to 20 mA*

Standard installation cable is sufficient.

*Status input*

Standard installation cable is sufficient.

#### **Cable diameter**

- Cable glands supplied:  
M20 × 1.5 with cable  $\varnothing$  6 to 12 mm (0.24 to 0.47 in)
- Spring-loaded terminals: Suitable for strands and strands with ferrules.  
Conductor cross-section 0.2 to 2.5 mm<sup>2</sup> (24 to 12 AWG).

#### **Choice of connecting cable between the transmitter and sensor**

Depends on the type of transmitter and the installation zones



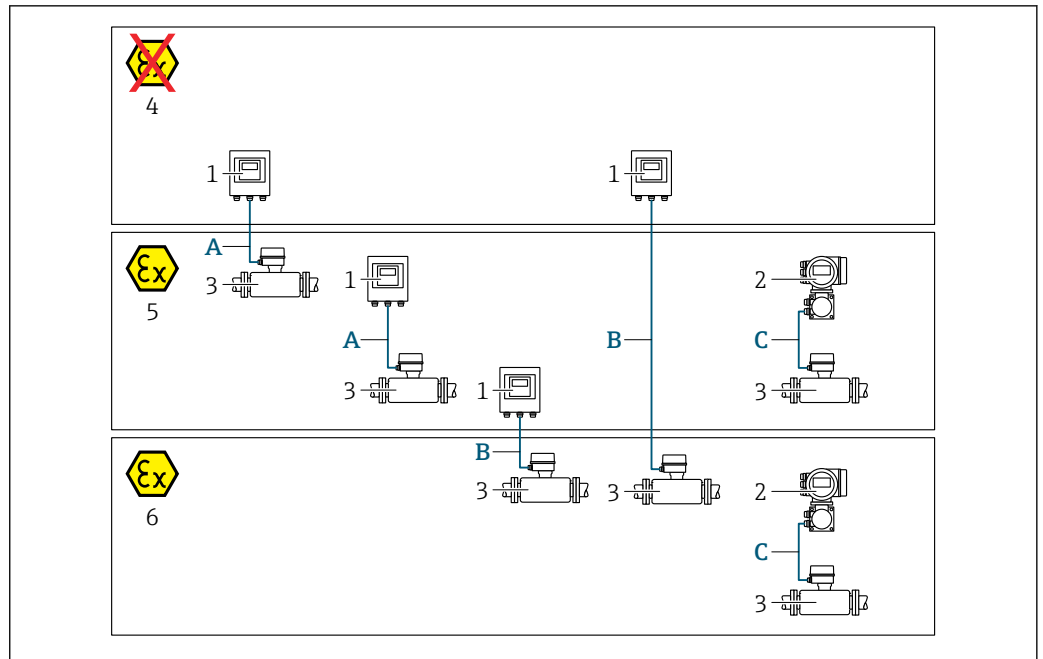

A0032476

- 1 Proline 500 digital transmitter
- 2 Proline 500 transmitter
- 3 Sensor Promass
- 4 Non-hazardous area
- 5 Hazardous area: Zone 2; Class I, Division 2
- 6 Hazardous area: Zone 1; Class I, Division 1
- A Standard cable to 500 digital transmitter → 37  
Transmitter installed in the non-hazardous area or hazardous area: Zone 2; Class I, Division 2 / sensor installed in the hazardous area: Zone 2; Class I, Division 2
- B Standard cable to 500 digital transmitter → 38  
Transmitter installed in the hazardous area: Zone 2; Class I, Division 2 / sensor installed in the hazardous area: Zone 1; Class I, Division 1
- C Signal cable to 500 transmitter → 40  
Transmitter and sensor installed in the hazardous area: Zone 2; Class I, Division 2 oder Zone 1; Class I, Division 1

A: Connecting cable between sensor and transmitter: Proline 500 – digital

Standard cable

A standard cable with the following specifications can be used as the connecting cable.

<b>Design</b>	4 cores (2 pairs); uninsulated stranded CU wires; pair-stranded with common shield
<b>Shielding</b>	Tin-plated copper-braid, optical cover ≥ 85 %
<b>Loop resistance</b>	Power supply line (+, -): maximum 10 Ω
<b>Cable length</b>	Maximum 300 m (1 000 ft), see the following table.

Cross-section	Cable length [max.]
0.34 mm <sup>2</sup> (AWG 22)	80 m (270 ft)
0.50 mm <sup>2</sup> (AWG 20)	120 m (400 ft)
0.75 mm <sup>2</sup> (AWG 18)	180 m (600 ft)
1.00 mm <sup>2</sup> (AWG 17)	240 m (800 ft)
1.50 mm <sup>2</sup> (AWG 15)	300 m (1 000 ft)

*Optionally available connecting cable*

<b>Design</b>	2 × 2 × 0.34 mm <sup>2</sup> (AWG 22) PVC cable <sup>1)</sup> with common shield (2 pairs, uninsulated stranded CU wires; pair-stranded)
<b>Flame resistance</b>	According to DIN EN 60332-1-2
<b>Oil-resistance</b>	According to DIN EN 60811-2-1
<b>Shielding</b>	Tin-plated copper-braid, optical cover ≥ 85 %
<b>Operating temperature</b>	When mounted in a fixed position: -50 to +105 °C (-58 to +221 °F); when cable can move freely: -25 to +105 °C (-13 to +221 °F)
<b>Available cable length</b>	Fixed: 20 m (65 ft); variable: up to maximum 50 m (165 ft)

1) UV radiation can impair the cable outer sheath. Protect the cable from direct sunshine where possible.

*B: Connecting cable between sensor and transmitter: Proline 500 - digital**Standard cable*

A standard cable with the following specifications can be used as the connecting cable.

<b>Design</b>	4, 6, 8 cores (2, 3, 4 pairs); uninsulated stranded CU wires; pair-stranded with common shield
<b>Shielding</b>	Tin-plated copper-braid, optical cover ≥ 85 %
<b>Capacitance C</b>	Maximum 760 nF IIC, maximum 4.2 µF IIB
<b>Inductance L</b>	Maximum 26 µH IIC, maximum 104 µH IIB
<b>Inductance/resistance ratio (L/R)</b>	Maximum 8.9 µH/Ω IIC, maximum 35.6 µH/Ω IIB (e.g. in accordance with IEC 60079-25)
<b>Loop resistance</b>	Power supply line (+, -): maximum 5 Ω
<b>Cable length</b>	Maximum 150 m (500 ft), see the following table.

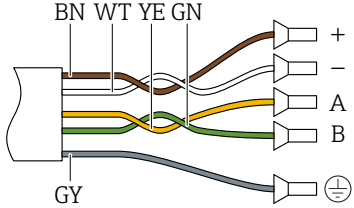
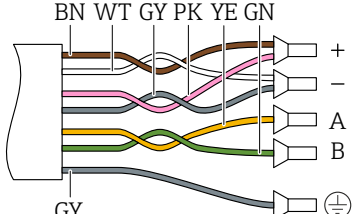
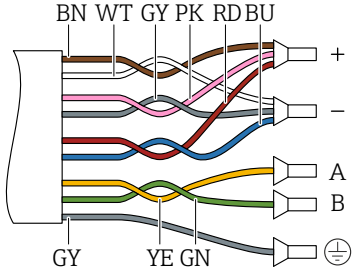
Cross-section	Cable length [max.]	Termination
2 x 2 x 0.50 mm <sup>2</sup> (AWG 20)	50 m (165 ft)	2 x 2 x 0.50 mm <sup>2</sup> (AWG 20)  <ul style="list-style-type: none"> <li>▪ +, - = 0.5 mm<sup>2</sup></li> <li>▪ A, B = 0.5 mm<sup>2</sup></li> </ul>
3 x 2 x 0.50 mm <sup>2</sup> (AWG 20)	100 m (330 ft)	3 x 2 x 0.50 mm <sup>2</sup> (AWG 20)  <ul style="list-style-type: none"> <li>▪ +, - = 1.0 mm<sup>2</sup></li> <li>▪ A, B = 0.5 mm<sup>2</sup></li> </ul>
4 x 2 x 0.50 mm <sup>2</sup> (AWG 20)	150 m (500 ft)	4 x 2 x 0.50 mm <sup>2</sup> (AWG 20)  <ul style="list-style-type: none"> <li>▪ +, - = 1.5 mm<sup>2</sup></li> <li>▪ A, B = 0.5 mm<sup>2</sup></li> </ul>

*Optionally available connecting cable*

<b>Connecting cable for</b>	Zone 1; Class I, Division 1
<b>Standard cable</b>	2 × 2 × 0.5 mm <sup>2</sup> (AWG 20) PVC cable <sup>1)</sup> with common shield (2 pairs, pair-stranded)
<b>Flame resistance</b>	According to DIN EN 60332-1-2
<b>Oil-resistance</b>	According to DIN EN 60811-2-1
<b>Shielding</b>	Tin-plated copper-braid, optical cover ≥ 85 %
<b>Operating temperature</b>	When mounted in a fixed position: -50 to +105 °C (-58 to +221 °F); when cable can move freely: -25 to +105 °C (-13 to +221 °F)
<b>Available cable length</b>	Fixed: 20 m (65 ft); variable: up to maximum 50 m (165 ft)

1) UV radiation can impair the cable outer sheath. Protect the cable from direct sunshine where possible.

*C: Connecting cable between sensor and transmitter: Proline 500*

Standard cable	6 × 0.38 mm <sup>2</sup> PVC cable <sup>1)</sup> with common shield and individually shielded cores
Conductor resistance	≤50 Ω/km (0.015 Ω/ft)
Capacitance: core/shield	≤420 pF/m (128 pF/ft)
Cable length (max.)	20 m (65 ft)
Cable lengths (available for order)	5 m (15 ft), 10 m (32 ft), 20 m (65 ft)
Operating temperature	max. 105 °C (221 °F)

1) UV radiation can impair the cable outer sheath. Protect the cable from direct sunshine where possible.

### 7.1.3 Terminal assignment

#### Transmitter: supply voltage, input/outputs



The terminal assignment of the inputs and outputs depends on the individual order version of the device. The device-specific terminal assignment is documented on an adhesive label in the terminal cover.

Supply voltage		Input/output 1		Input/output 2		Input/output 3		Input/output 4	
1 (+)	2 (-)	26 (B)	27 (A)	24 (+)	25 (-)	22 (+)	23 (-)	20 (+)	21 (-)
Device-specific terminal assignment: adhesive label in terminal cover.									

#### Transmitter and sensor connection housing: connecting cable

The sensor and transmitter, which are mounted in separate locations, are interconnected by a connecting cable. The cable is connected via the sensor connection housing and the transmitter housing.

Terminal assignment and connection of the connecting cable:

- Proline 500 – digital →  43
- Proline 500 →  50

### 7.1.4 Shielding and grounding

Optimum electromagnetic compatibility (EMC) of the fieldbus system can only be guaranteed if the system components and, in particular, the lines are shielded and the shield forms as complete a cover as possible. A shield coverage of 90% is ideal.

- To ensure an optimum EMC protective effect, connect the shield as often as possible to the reference ground.
- For reasons of explosion protection, you should refrain from grounding however.

To comply with both requirements, the fieldbus system allows three different types of shielding:

- Shielding at both ends.
- Shielding at one end on the feed side with capacitance termination at the field device.
- Shielding at one end on the feed side.

Experience shows that the best results with regard to EMC are achieved in most cases in installations with one-sided shielding on the feed side (without capacitance termination at the field device). Appropriate measures with regard to input wiring must be taken to allow unrestricted operation when EMC interference is present. These measures have been taken into account for this device. Operation in the event of disturbance variables as per NAMUR NE21 is thus guaranteed.

Where applicable, national installation regulations and guidelines must be observed during the installation!

Where there are large differences in potential between the individual grounding points, only one point of the shielding is connected directly with the reference ground. In systems without potential equalization, therefore, cable shielding of fieldbus systems should only be grounded on one side, for example at the fieldbus supply unit or at safety barriers.

#### NOTICE

**In systems without potential matching, the multiple grounding of the cable shield causes mains frequency equalizing currents!**

Damage to the bus cable shield.

- ▶ Only ground the bus cable shield to either the local ground or the protective ground at one end. Insulate the shield that is not connected.

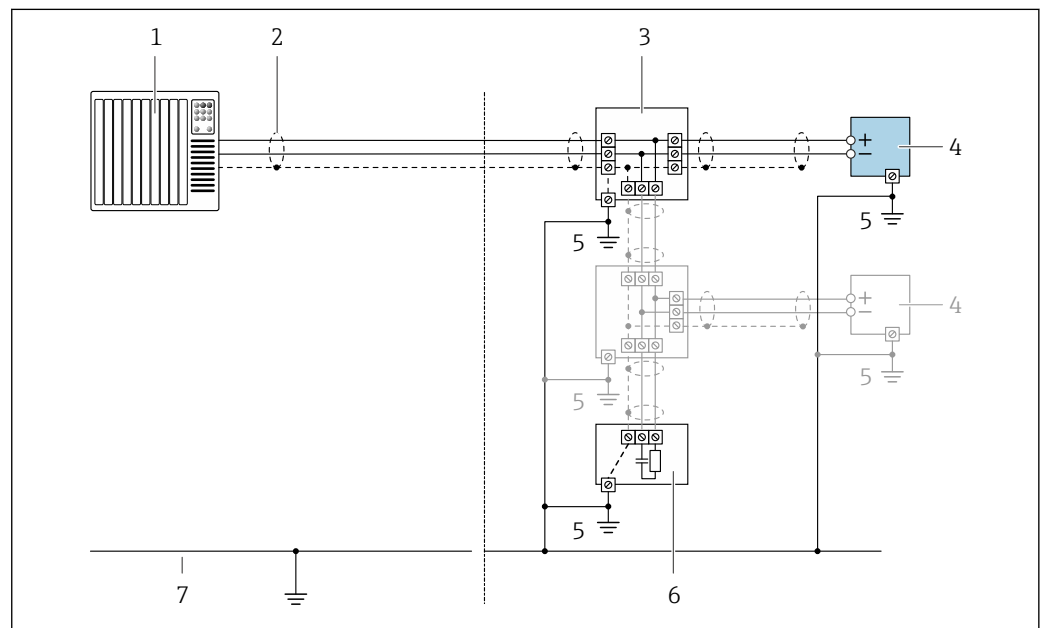

- 1 Controller (e.g. PLC)
- 2 Cable shield
- 3 T-box
- 4 Measuring device
- 5 Local grounding
- 6 Bus terminator
- 7 Potential matching line

### 7.1.5 Preparing the measuring device

Carry out the steps in the following order:

1. Mount the sensor and transmitter.
2. Connection housing, sensor: Connect connecting cable.
3. Transmitter: Connect connecting cable.
4. Transmitter: Connect signal cable and cable for supply voltage.

#### NOTICE

**Insufficient sealing of the housing!**

Operational reliability of the measuring device could be compromised.

- ▶ Use suitable cable glands corresponding to the degree of protection.

1. Remove dummy plug if present.

2. If the measuring device is supplied without cable glands:  
Provide suitable cable gland for corresponding connecting cable.
3. If the measuring device is supplied with cable glands:  
Observe requirements for connecting cables →  35.

## 7.2 Connecting the measuring device: Proline 500 - digital

### NOTICE

#### Limitation of electrical safety due to incorrect connection!

- ▶ Have electrical connection work carried out by appropriately trained specialists only.
- ▶ Observe applicable federal/national installation codes and regulations.
- ▶ Comply with local workplace safety regulations.
- ▶ Always connect the protective ground cable ⊕ before connecting additional cables.
- ▶ For use in potentially explosive atmospheres, observe the information in the device-specific Ex documentation.

### 7.2.1 Connecting the connecting cable

#### ⚠ WARNING

#### Risk of damaging the electronic components!

- ▶ Connect the sensor and transmitter to the same potential equalization.
- ▶ Only connect the sensor to a transmitter with the same serial number.
- ▶ Ground the connection housing of the sensor via the external screw terminal.

#### Connecting cable terminal assignment

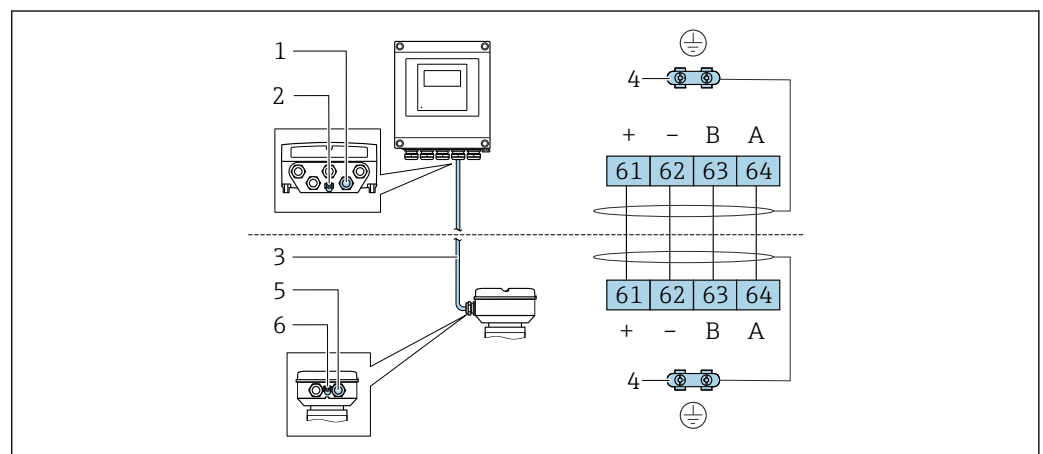

A0028198

- 1 Cable entry for cable on transmitter housing
- 2 Protective earth (PE)
- 3 Connecting cable ISEM communication
- 4 Grounding via ground connection; on device plug versions grounding is through the plug itself
- 5 Cable entry for cable or connection of device plug on sensor connection housing
- 6 Protective earth (PE)

#### Connecting the connecting cable to the sensor connection housing

- Connection via terminals with order code for "Sensor connection housing":
  - Option A "Aluminum, coated" → ☰ 44
  - Option B "Stainless" → ☰ 45
- Connection via connectors with order code for "Sensor connection housing":
  - Option C "Ultra-compact hygienic, stainless" → ☰ 46

#### Connecting the connecting cable to the transmitter

The cable is connected to the transmitter via terminals → ☰ 47.

### Connecting the sensor connection housing via terminals

For the device version with the order code for "Sensor connection housing":  
Option A "Aluminum coated"

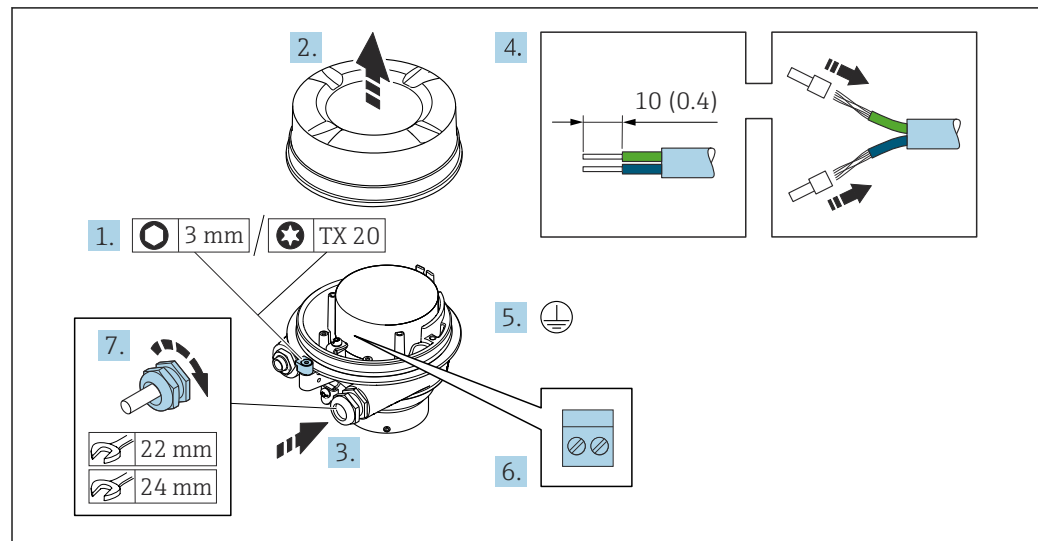

A0029616

1. Loosen the securing clamp of the housing cover.
2. Unscrew the housing cover.
3. Push the cable through the cable entry. To ensure tight sealing, do not remove the sealing ring from the cable entry.
4. Strip the cable and cable ends. In the case of stranded cables, fit ferrules.
5. Connect the protective ground.
6. Connect the cable in accordance with the connecting cable terminal assignment.
7. Firmly tighten the cable glands.
  - ↳ This concludes the process for connecting the connecting cable.

#### **⚠ WARNING**

#### **Housing degree of protection voided due to insufficient sealing of the housing.**

- ▶ Screw in the thread on the cover without using any lubricant. The thread on the cover is coated with a dry lubricant.
8. Screw on the housing cover.
  9. Tighten the securing clamp of the housing cover.



### Connecting the sensor connection housing via terminals

For the device version with the order code for "Sensor connection housing":  
Option B "Stainless"

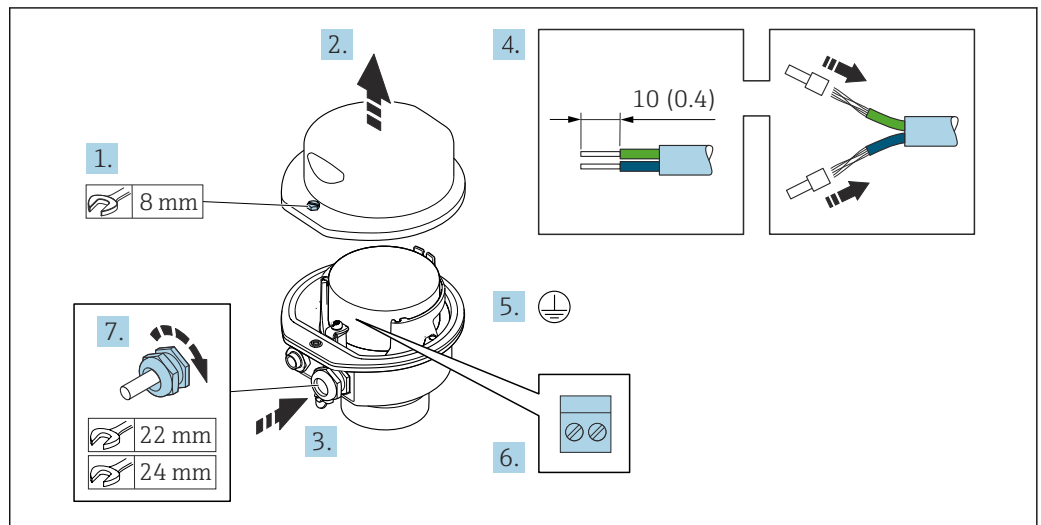

A0029613

1. Release the securing screw of the housing cover.
2. Open the housing cover.
3. Push the cable through the cable entry . To ensure tight sealing, do not remove the sealing ring from the cable entry.
4. Strip the cable and cable ends. In the case of stranded cables, fit ferrules.
5. Connect the protective ground.
6. Connect the cable in accordance with the connecting cable terminal assignment.
7. Firmly tighten the cable glands.
  - ↳ This concludes the process for connecting the connecting cable.
8. Close the housing cover.
9. Tighten the securing screw of the housing cover.

**Connecting the sensor connection housing via the connector**

For the device version with the order code for "Sensor connection housing":  
Option **C** "Ultra-compact hygienic, stainless"

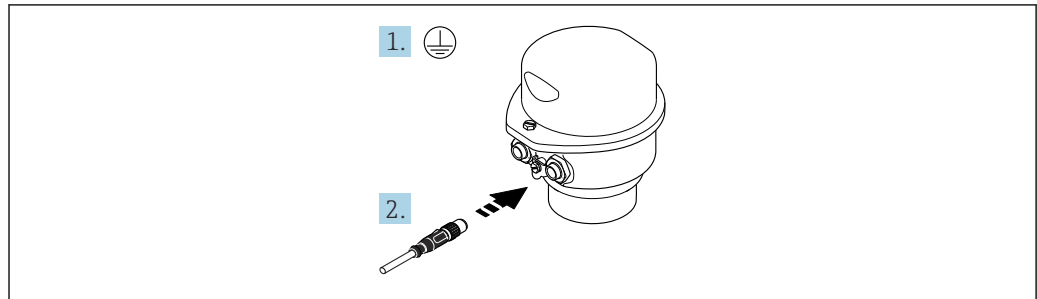

A0029615

1. Connect the protective ground.
2. Connect the connector.

## Connecting the connecting cable to the transmitter

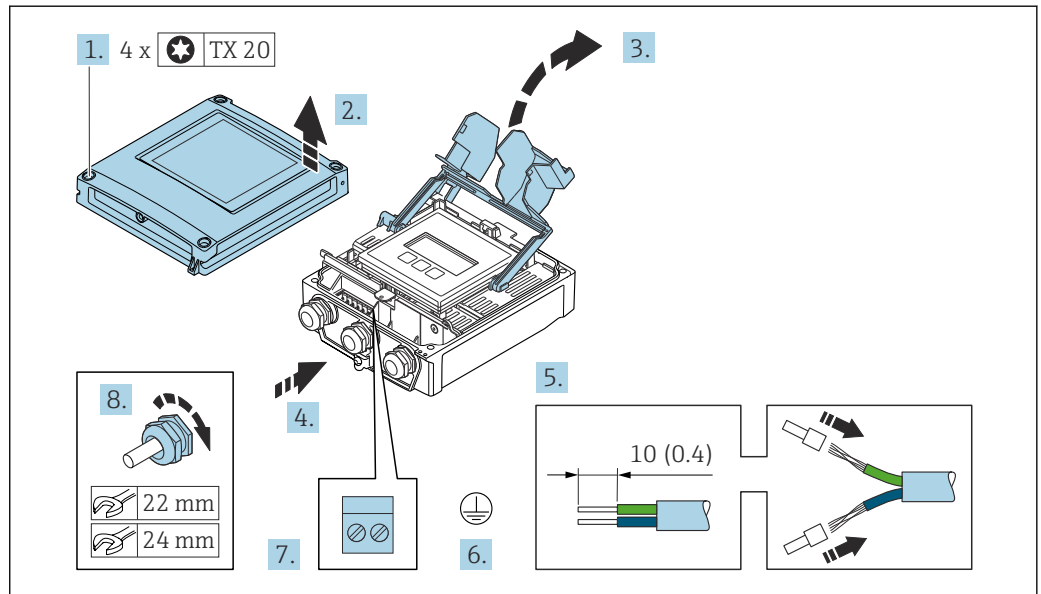

A0029597

1. Loosen the 4 fixing screws on the housing cover.
2. Open the housing cover.
3. Fold open the terminal cover.
4. Push the cable through the cable entry. To ensure tight sealing, do not remove the sealing ring from the cable entry.
5. Strip the cable and cable ends. In the case of stranded cables, fit ferrules.
6. Connect the protective ground.
7. Connect the cable in accordance with the connecting cable terminal assignment → 43.
8. Firmly tighten the cable glands.
  - ↳ This concludes the process for connecting the connecting cable.
9. Close the housing cover.
10. Tighten the securing screw of the housing cover.
11. After connecting the connecting cable:
  - Connect the signal cable and the supply voltage cable → 48.

## 7.2.2 Connecting the signal cable and the supply voltage cable

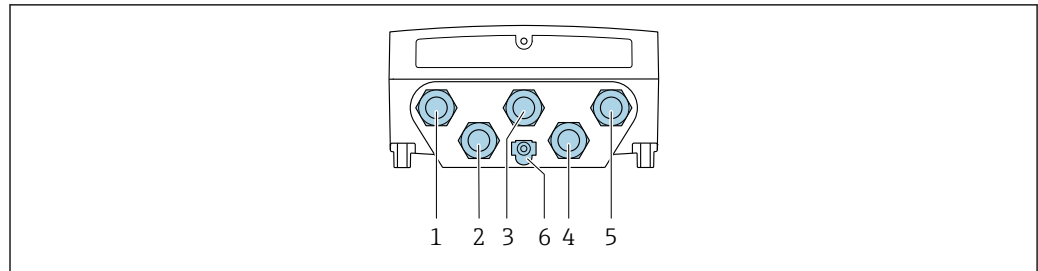

A0028200

- 1 Terminal connection for supply voltage
- 2 Terminal connection for signal transmission, input/output
- 3 Terminal connection for signal transmission, input/output
- 4 Terminal connection for connecting cable between sensor and transmitter
- 5 Terminal connection for signal transmission, input/output; optional: connection for external WLAN antenna
- 6 Protective earth (PE)

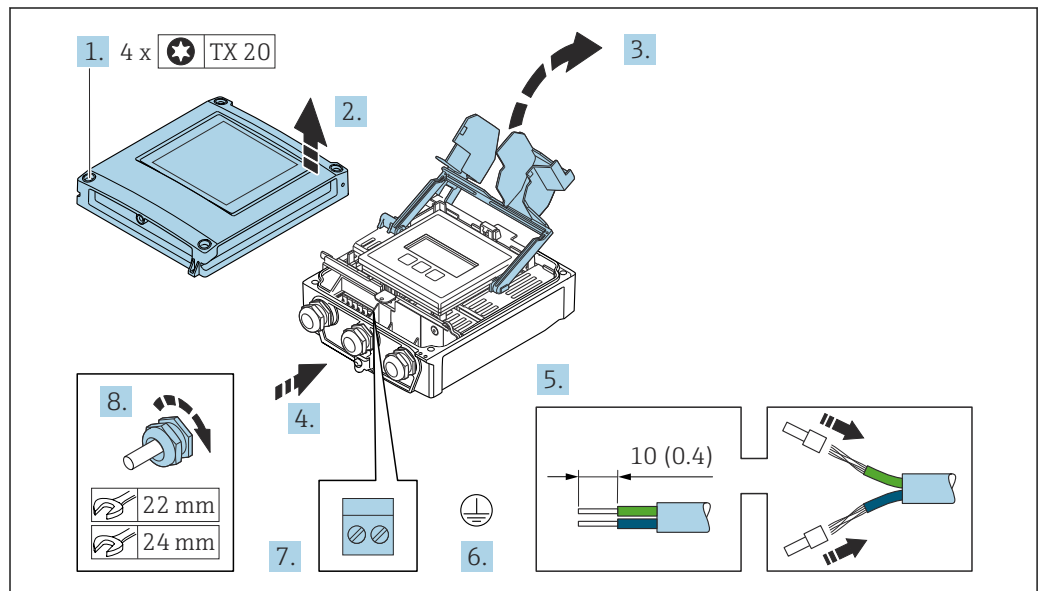

A0029597

1. Loosen the 4 fixing screws on the housing cover.
2. Open the housing cover.
3. Fold open the terminal cover.
4. Push the cable through the cable entry. To ensure tight sealing, do not remove the sealing ring from the cable entry.
5. Strip the cable and cable ends. In the case of stranded cables, fit ferrules.
6. Connect the protective ground.
7. Connect the cable in accordance with the terminal assignment .
  - ↳ **Signal cable terminal assignment:** The device-specific terminal assignment is documented on an adhesive label in the terminal cover.
  - Supply voltage terminal assignment:** Adhesive label in the terminal cover or → 40.
8. Firmly tighten the cable glands.
  - ↳ This concludes the cable connection process.
9. Close the terminal cover.
10. Close the housing cover.

**⚠ WARNING**

Housing degree of protection may be voided due to insufficient sealing of the housing.

- ▶ Screw in the screw without using any lubricant.

**⚠ WARNING**

Excessive tightening torque applied to the fixing screws!

Risk of damaging the plastic transmitter.

- ▶ Tighten the fixing screws as per the tightening torque: 2 Nm (1.5 lbf ft)

11. Tighten the 4 fixing screws on the housing cover.

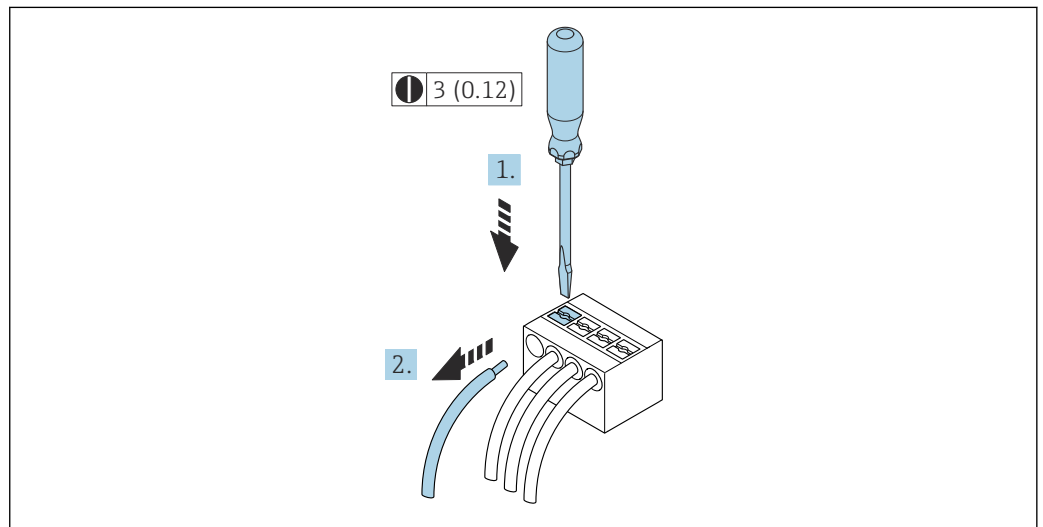
**Removing a cable**

15 Engineering unit mm (in)

1. To remove a cable from the terminal, use a flat-blade screwdriver to push the slot between the two terminal holes
2. while simultaneously pulling the cable end out of the terminal.

## 7.3 Connecting the measuring device: Proline 500

### NOTICE

#### Limitation of electrical safety due to incorrect connection!

- ▶ Have electrical connection work carried out by appropriately trained specialists only.
- ▶ Observe applicable federal/national installation codes and regulations.
- ▶ Comply with local workplace safety regulations.
- ▶ Always connect the protective ground cable ⊕ before connecting additional cables.
- ▶ For use in potentially explosive atmospheres, observe the information in the device-specific Ex documentation.

### 7.3.1 Connecting the connecting cable

#### ⚠ WARNING

#### Risk of damaging the electronic components!

- ▶ Connect the sensor and transmitter to the same potential equalization.
- ▶ Only connect the sensor to a transmitter with the same serial number.
- ▶ Ground the connection housing of the sensor via the external screw terminal.

#### Connecting cable terminal assignment

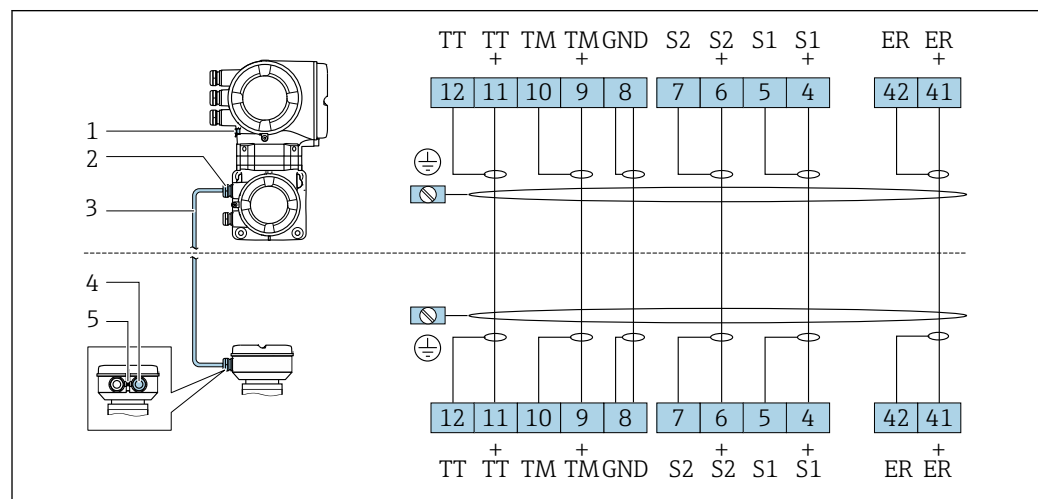

A0028197

- 1 Protective earth (PE)
- 2 Cable entry for connecting cable on transmitter connection housing
- 3 Connecting cable
- 4 Cable entry for connecting cable on sensor connection housing
- 5 Protective earth (PE)

#### Connecting the connecting cable to the sensor connection housing

Connection via terminals with order code for "Housing":

Option **B** "Stainless" → 51

#### Connecting the connecting cable to the transmitter

The cable is connected to the transmitter via terminals → 52.

### Connecting the sensor connection housing via terminals

For the device version with the order code for "Housing":  
Option B "Stainless"

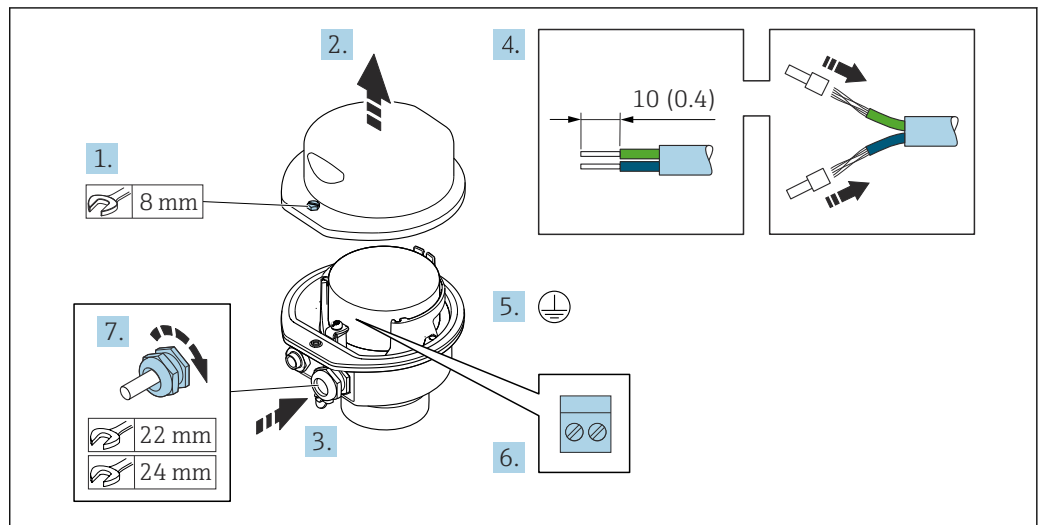

A0029613

1. Release the securing screw of the housing cover.
2. Open the housing cover.
3. Push the cable through the cable entry . To ensure tight sealing, do not remove the sealing ring from the cable entry.
4. Strip the cable and cable ends. In the case of stranded cables, fit ferrules.
5. Connect the protective ground.
6. Connect the cable in accordance with the connecting cable terminal assignment.
7. Firmly tighten the cable glands.
  - ↳ This concludes the process for connecting the connecting cable.
8. Close the housing cover.
9. Tighten the securing screw of the housing cover.

### Connecting the connecting cable to the transmitter

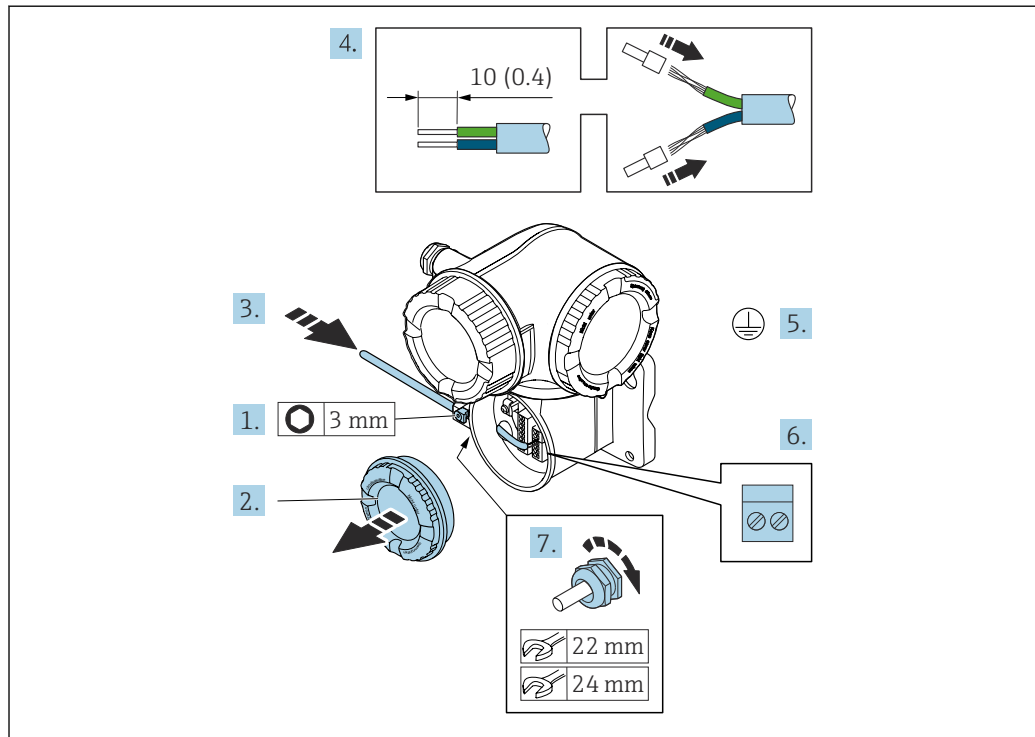

A0029592

1. Loosen the securing clamp of the connection compartment cover.
2. Unscrew the connection compartment cover.
3. Push the cable through the cable entry . To ensure tight sealing, do not remove the sealing ring from the cable entry.
4. Strip the cable and cable ends. In the case of stranded cables, also fit ferrules.
5. Connect the protective ground.
6. Connect the cable in accordance with the connecting cable terminal assignment  
→ 50.
7. Firmly tighten the cable glands.  
↳ This concludes the process for connecting the connecting cable.
8. Screw on the connection compartment cover.
9. Tighten the securing clamp of the connection compartment cover.
10. After connecting the connecting cable: After connecting the connecting cables:  
Connect the signal cable and the supply voltage cable .

## 7.4 Ensuring potential equalization

### 7.4.1 Requirements

No special measures for potential equalization are required.



## 7.5 Special connection instructions

### 7.5.1 Connection examples

#### PROFIBUS DP

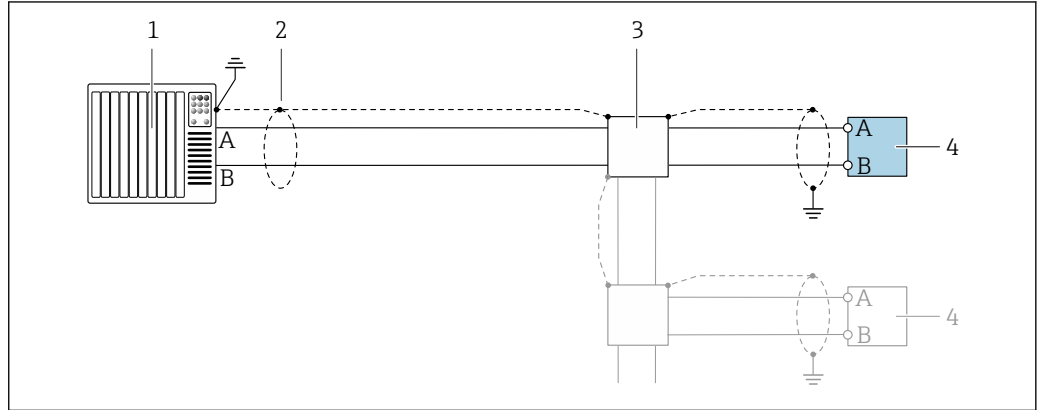

A0028765

16 Connection example for PROFIBUS DP, non-hazardous area and Zone 2/Div. 2

- 1 Control system (e.g. PLC)
- 2 Cable shield provided at one end. The cable shield must be grounded at both ends to comply with EMC requirements; observe cable specifications
- 3 Distribution box
- 4 Transmitter

**i** If baud rates > 1.5 MBaud an EMC cable entry must be used and the cable shield must continue as far as the terminal wherever possible.

#### Current output 4-20 mA

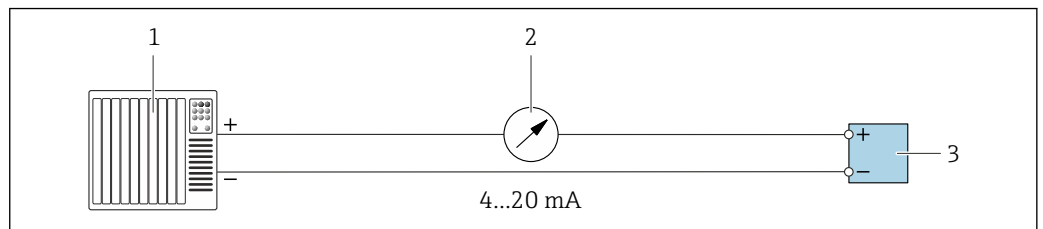

A0028758

17 Connection example for 4-20 mA current output (active)

- 1 Automation system with current input (e.g. PLC)
- 2 Analog display unit: observe maximum load
- 3 Transmitter

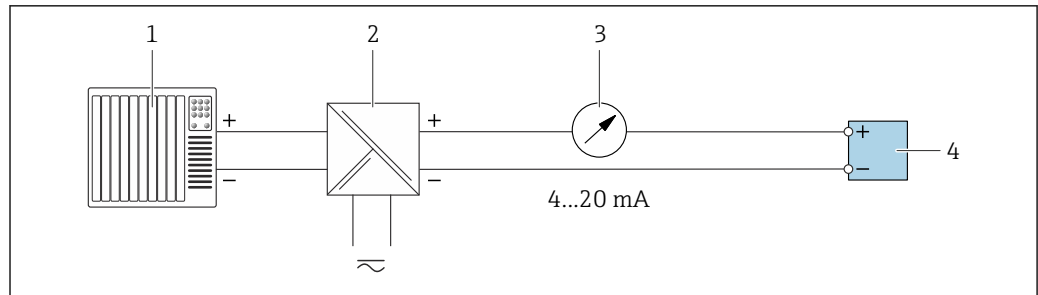

A0028759

18 Connection example for 4-20 mA current output (passive)

- 1 Automation system with current input (e.g. PLC)
- 2 Active barrier for power supply (e.g. RN221N)
- 3 Analog display unit: observe maximum load
- 4 Transmitter

### Pulse/frequency output



A0028761

19 Connection example for pulse/frequency output (passive)

- 1 Automation system with pulse/frequency input (e.g. PLC)
- 2 Power supply
- 3 Transmitter: Observe input values → 243

### Switch output

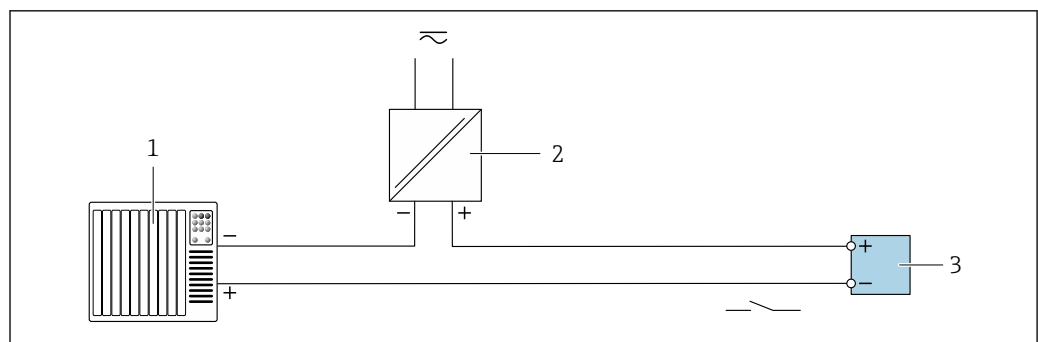

A0028760

20 Connection example for switch output (passive)

- 1 Automation system with switch input (e.g. PLC)
- 2 Power supply
- 3 Transmitter: Observe input values → 243

### Relay output

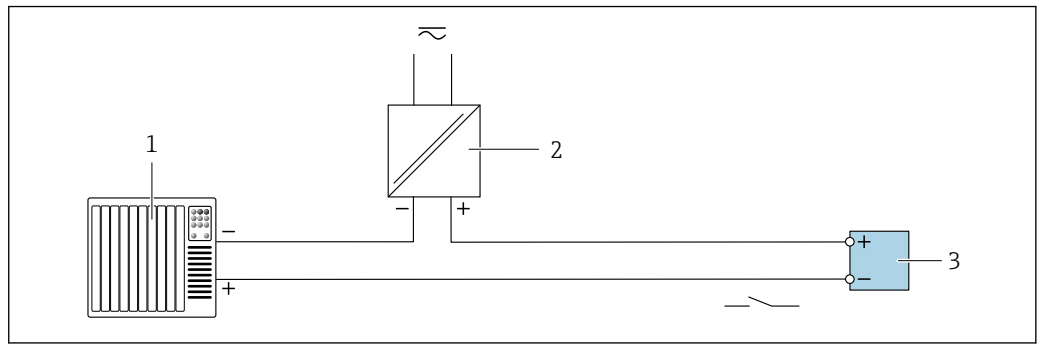

A0028760

21 Connection example for relay output (passive)

- 1 Automation system with relay input (e.g. PLC)
- 2 Power supply
- 3 Transmitter: Observe input values → 244

### Current input

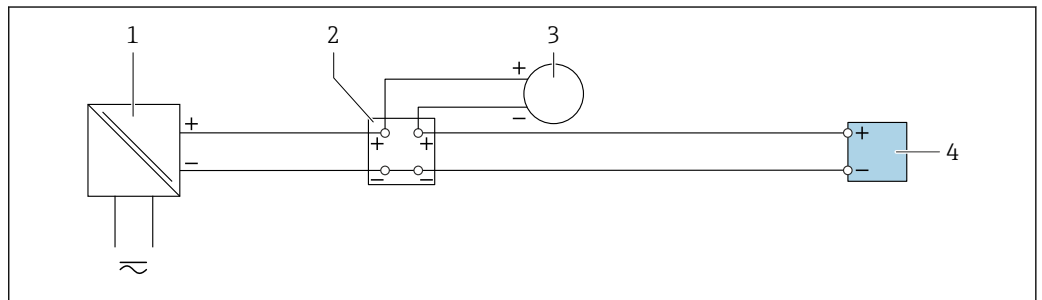

A0028915

22 Connection example for 4 to 20 mA current input

- 1 Power supply
- 2 Terminal box
- 3 External measuring device (to read in pressure or temperature, for instance)
- 4 Transmitter

### Status input

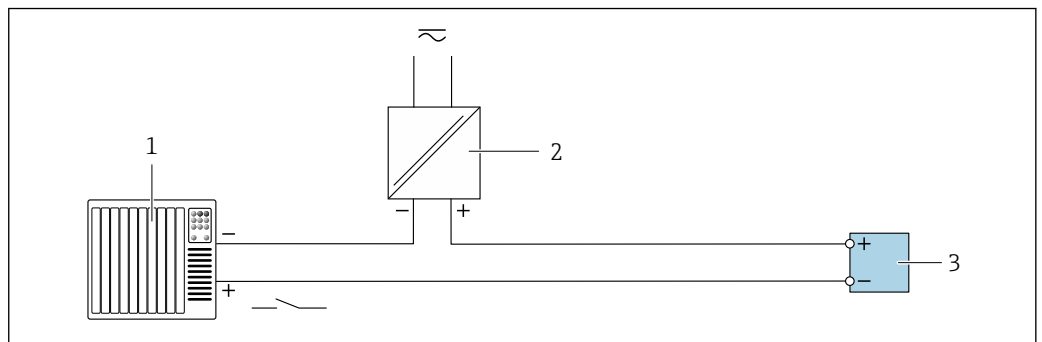

A0028764

23 Connection example for status input

- 1 Automation system with status output (e.g. PLC)
- 2 Power supply
- 3 Transmitter

## 7.6 Hardware settings

### 7.6.1 Setting the device address

The address must always be configured for a PROFIBUS DP/PA device. The valid address range is between 1 and 126. In a PROFIBUS DP/PA network, each address can only be assigned once. If an address is not configured correctly, the device is not recognized by the master. All measuring devices are delivered from the factory with the device address 126 and with the software addressing method.

#### Proline 500 – digital transmitter

##### Hardware addressing

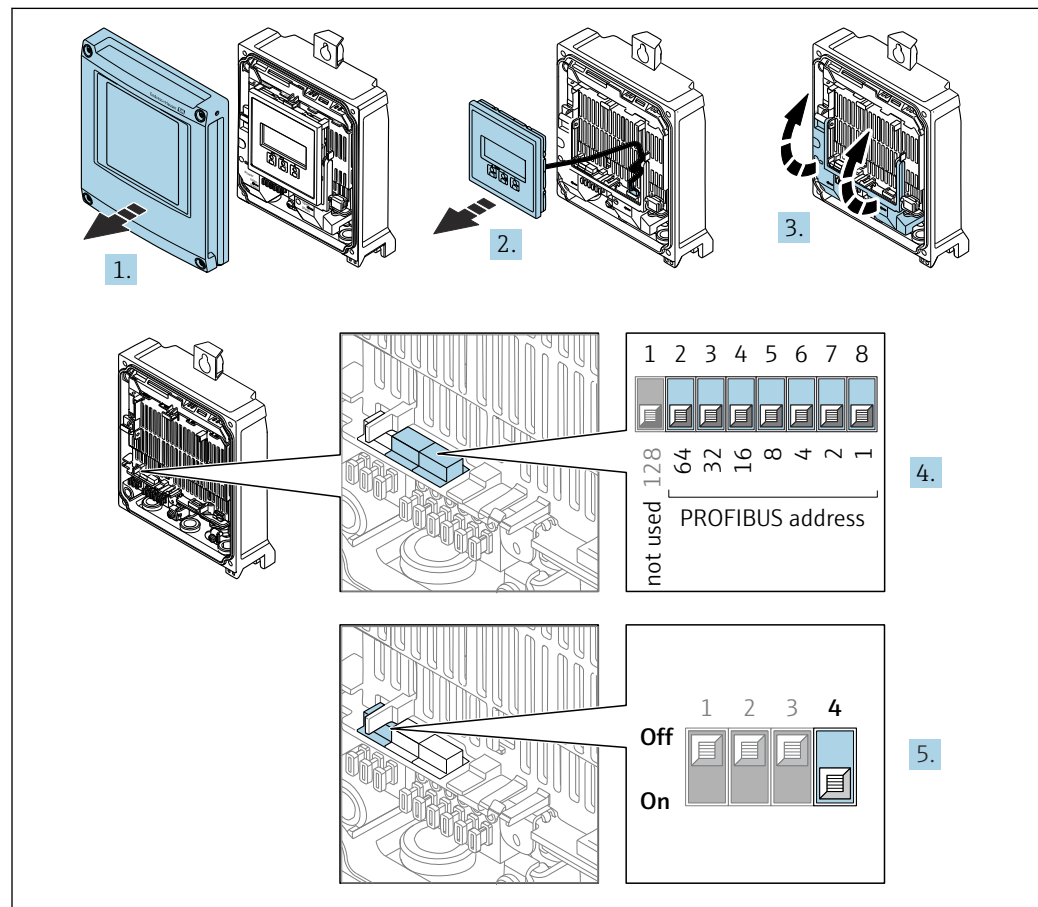

A0029679

1. Open the housing cover.
2. Remove the display module.
3. Fold open the terminal cover.
4. Set the desired device address using the DIP switches.
5. To switch addressing from software addressing to hardware addressing: set the DIP switch to **On**.
  - ↳ The change of device address takes effect after 10 seconds. The device is restarted.

##### Software addressing

- ▶ To switch addressing from hardware addressing to software addressing: set DIP switch No. 4 to **Off**.
  - ↳ The device address configured in the **Device address** parameter (→ 109) takes effect after 10 seconds. The device is restarted.

## Proline 500 transmitter

### Hardware addressing

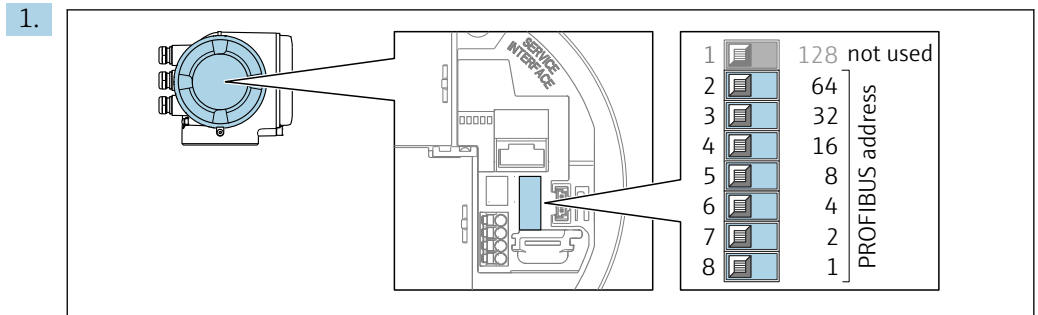

Set the desired device address using the DIP switches in the connection compartment.

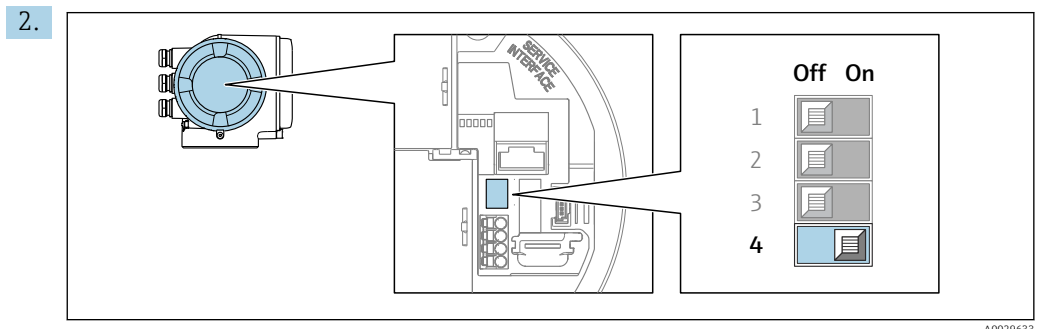

To switch addressing from software addressing to hardware addressing: set the DIP switch to **On**.

↳ The change of device address takes effect after 10 seconds. The device is restarted.

### Software addressing

▶ To switch addressing from hardware addressing to software addressing: set DIP switch No. 4 to **Off**.

↳ The device address configured in the **Device address** parameter (→ 109) takes effect after 10 seconds. The device is restarted.

## 7.6.2 Enabling the terminating resistor

To avoid incorrect communication transmission caused by impedance mismatch, terminate the PROFIBUS DP cable correctly at the start and end of the bus segment.

- If the device is operated with a baud rate of 1.5 MBaud and under:  
For the last transmitter on the bus, terminate by setting DIP switch 3 (bus termination) to ON.
- For baud rates > 1.5 MBaud:  
Due to the capacitance load of the user and the line reflections generated as a result, ensure that an external bus terminator is used.

**i** It is generally advisable to use an external bus terminator as the entire segment can fail if a device that is terminated internally is defective.

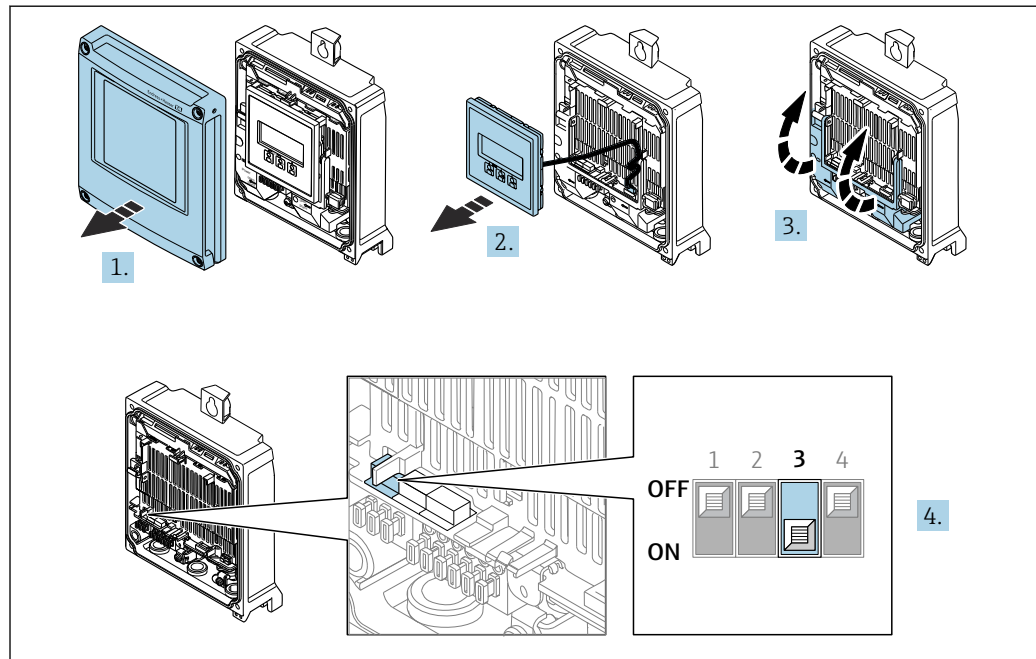
**Proline 500 – digital transmitter**

A0029675

1. Open the housing cover.
2. Remove the display module.
3. Fold open the terminal cover.
4. Set DIP switch No. 3 to **ON**.

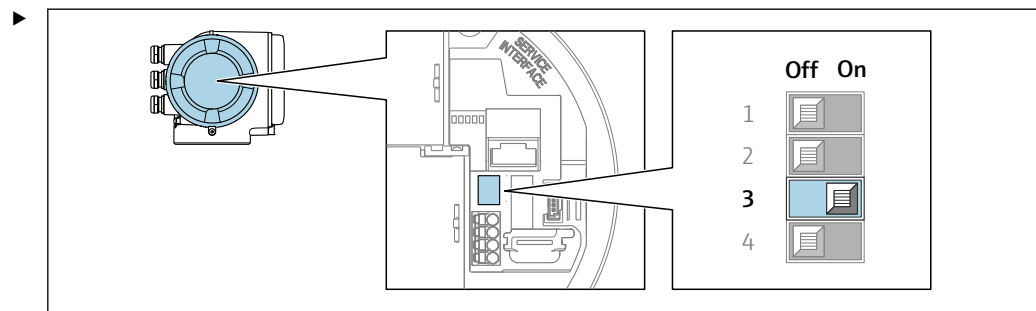
**Proline 500 transmitter**

A0029632

Set DIP switch No. 3 to **ON**.

**7.6.3 Activating the default IP address**

The default IP address 192.168.1.212 can be activated by DIP switch.

**Activating the default IP address by DIP switch: Proline 500 - digital**

Risk of electric shock when opening the transmitter housing.

- ▶ Before opening the transmitter housing:
- ▶ Disconnect the device from the power supply.

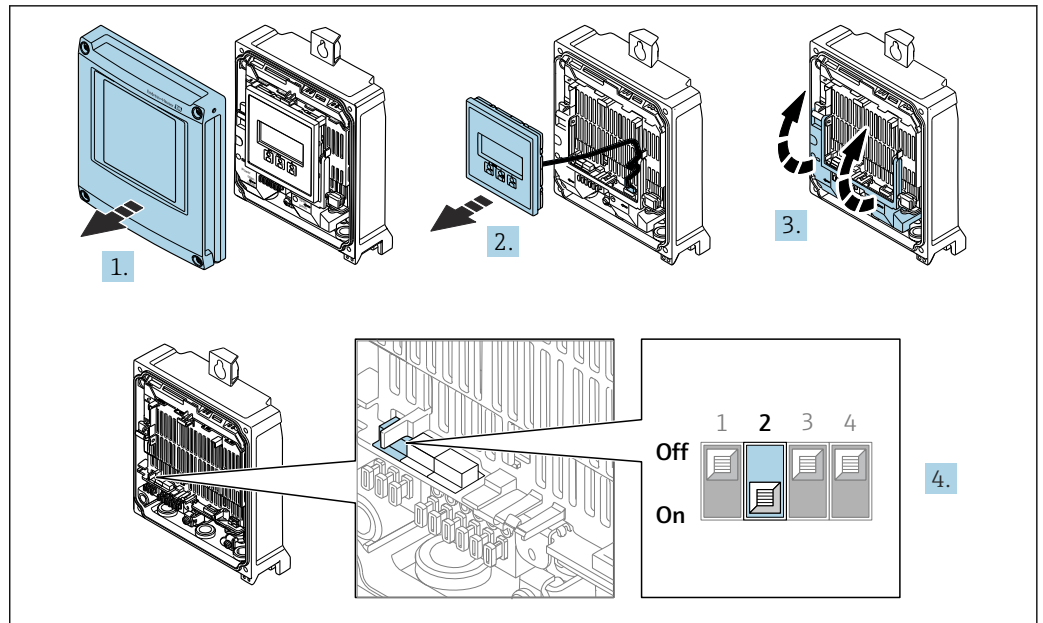

A0034500

1. Loosen the 4 fixing screws on the housing cover.
2. Open the housing cover.
3. Fold open the terminal cover.
4. Set DIP switch No. 2 on the I/O electronics module from **OFF** → **ON**.
5. Reverse the removal procedure to reassemble the transmitter.
6. Reconnect the device to the power supply.
  - ↳ The default IP address is used once the device is restarted.

**Activating the default IP address by DIP switch: Proline 500**

Risk of electric shock when opening the transmitter housing.

- ▶ Before opening the transmitter housing:
- ▶ Disconnect the device from the power supply.

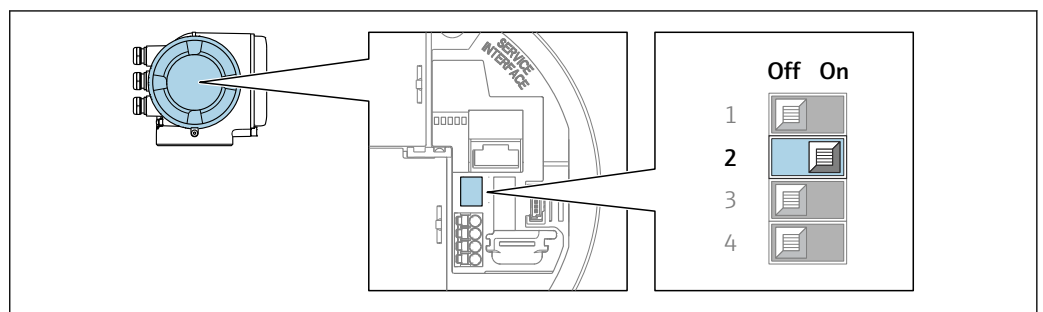

A0034499

1. Depending on the housing version, loosen the securing clamp or fixing screw of the housing cover.
2. Depending on the housing version, unscrew or open the housing cover and disconnect the local display from the main electronics module where necessary .
3. Set DIP switch No. 2 on the I/O electronics module from **OFF** → **ON**.
4. Reverse the removal procedure to reassemble the transmitter.
5. Reconnect the device to the power supply.
  - ↳ The default IP address is used once the device is restarted.

## 7.7 Ensuring the degree of protection

The measuring device fulfills all the requirements for the IP66/67 degree of protection, Type 4X enclosure.

To guarantee IP66/67 degree of protection, Type 4X enclosure, carry out the following steps after the electrical connection:

1. Check that the housing seals are clean and fitted correctly.
2. Dry, clean or replace the seals if necessary.
3. Tighten all housing screws and screw covers.
4. Firmly tighten the cable glands.
5. To ensure that moisture does not enter the cable entry:  
Route the cable so that it loops down before the cable entry ("water trap").

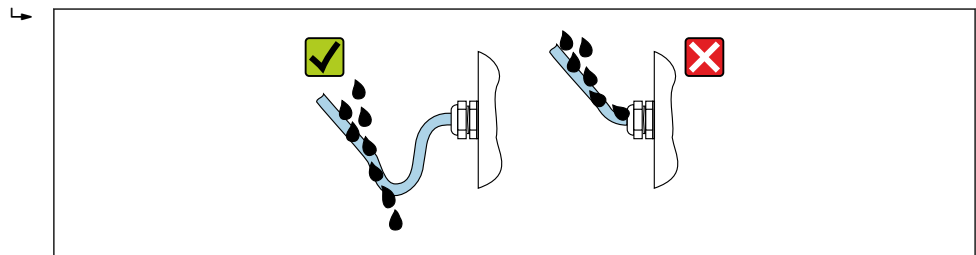

A0029278

6. Insert dummy plugs into unused cable entries.

## 7.8 Post-connection check

Are cables or the device undamaged (visual inspection)?	<input type="checkbox"/>
Do the cables used meet the requirements?	<input type="checkbox"/>
Do the cables have adequate strain relief?	<input type="checkbox"/>
Are all the cable glands installed, firmly tightened and leak-tight? Cable run with "water trap" → 60?	<input type="checkbox"/>



## 8 Operation options

### 8.1 Overview of operation options

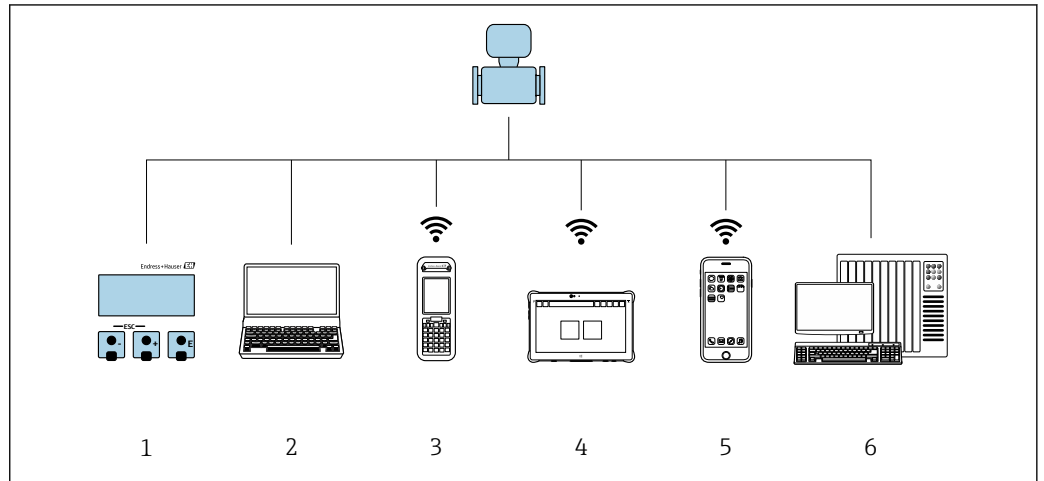



A0034513

- 1 Local operation via display module
- 2 Computer with Web browser (e.g. Internet Explorer) or with operating tool (e.g. FieldCare, DeviceCare, AMS Device Manager, SIMATIC PDM)
- 3 Field Xpert SFX350 or SFX370
- 4 Field Xpert SMT70
- 5 Mobile handheld terminal
- 6 Control system (e.g. PLC)

## 8.2 Structure and function of the operating menu

### 8.2.1 Structure of the operating menu

 For an overview of the operating menu for experts: "Description of Device Parameters" document supplied with the device →  267

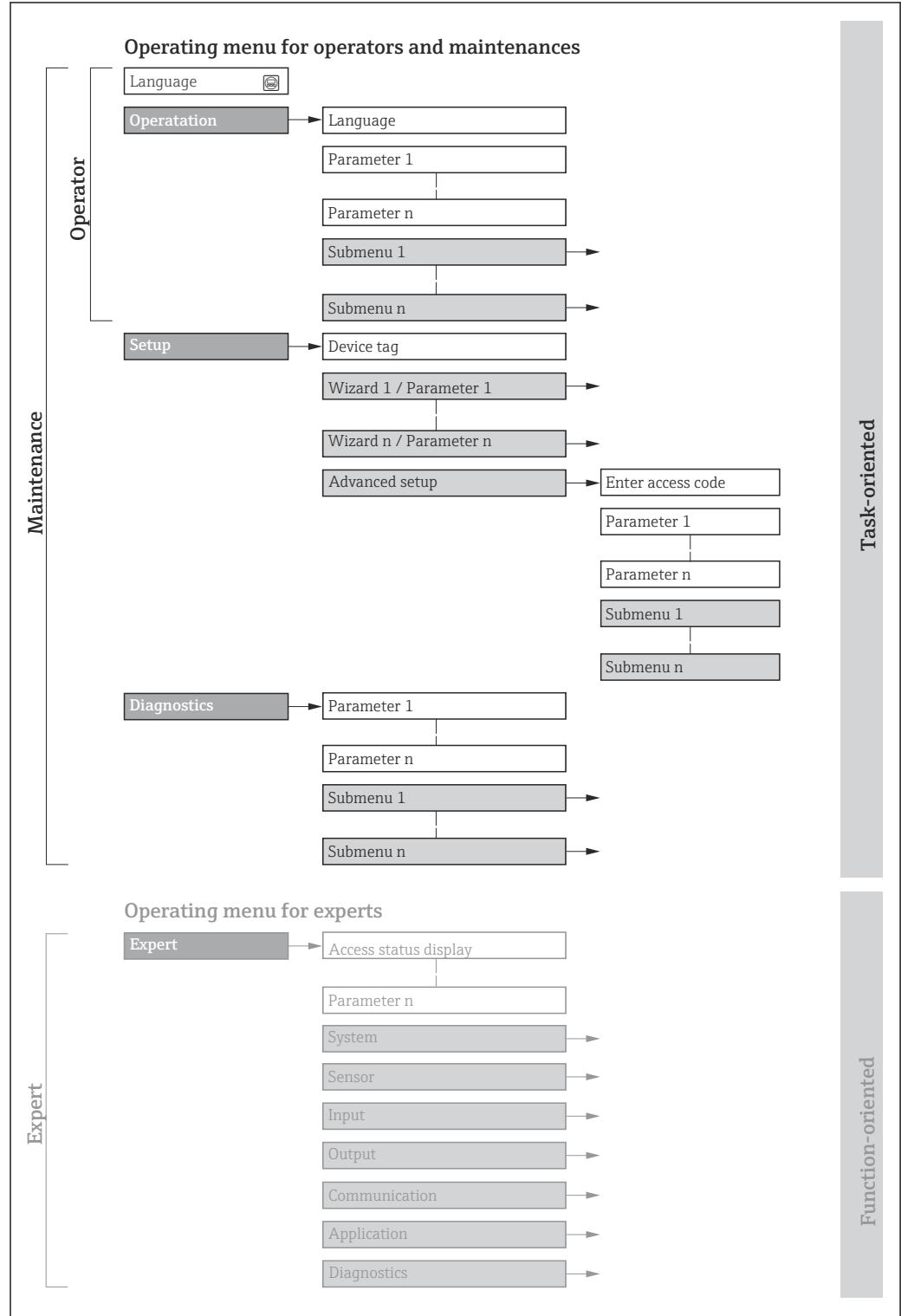

A0018237-EN

 24 Schematic structure of the operating menu

### 8.2.2 Operating philosophy

The individual parts of the operating menu are assigned to certain user roles (operator, maintenance etc.). Each user role contains typical tasks within the device lifecycle.

Menu/parameter		User role and tasks	Content/meaning
Language	task-oriented	<b>Role "Operator", "Maintenance"</b> Tasks during operation: <ul style="list-style-type: none"> <li>▪ Configuring the operational display</li> <li>▪ Reading measured values</li> </ul>	<ul style="list-style-type: none"> <li>▪ Defining the operating language</li> <li>▪ Defining the Web server operating language</li> <li>▪ Resetting and controlling totalizers</li> </ul>
Operation			<ul style="list-style-type: none"> <li>▪ Configuring the operational display (e.g. display format, display contrast)</li> <li>▪ Resetting and controlling totalizers</li> </ul>
Setup		<b>"Maintenance" role</b> Commissioning: <ul style="list-style-type: none"> <li>▪ Configuration of the measurement</li> <li>▪ Configuration of the inputs and outputs</li> <li>▪ Configuration of the communication interface</li> </ul>	Wizards for fast commissioning: <ul style="list-style-type: none"> <li>▪ Setting the system units</li> <li>▪ Configuration of the communication interface</li> <li>▪ Defining the medium</li> <li>▪ Displaying the I/O/configuration</li> <li>▪ Configuring the inputs</li> <li>▪ Configuring the outputs</li> <li>▪ Configuration of the operational display</li> <li>▪ Setting the low flow cut off</li> <li>▪ Configuring partial and empty pipe detection</li> </ul> Advanced setup <ul style="list-style-type: none"> <li>▪ For more customized configuration of the measurement (adaptation to special measuring conditions)</li> <li>▪ Configuration of totalizers</li> <li>▪ Configuring the WLAN settings</li> <li>▪ Administration (define access code, reset measuring device)</li> </ul>
Diagnostics	<b>"Maintenance" role</b> Fault elimination: <ul style="list-style-type: none"> <li>▪ Diagnostics and elimination of process and device errors</li> <li>▪ Measured value simulation</li> </ul>	Contains all parameters for error detection and analyzing process and device errors: <ul style="list-style-type: none"> <li>▪ Diagnostic list Contains up to 5 currently pending diagnostic messages.</li> <li>▪ Event logbook Contains event messages that have occurred.</li> <li>▪ Device information Contains information for identifying the device.</li> <li>▪ Measured values Contains all current measured values.</li> <li>▪ Analog inputs Is used to display the analog input.</li> <li>▪ <b>Data logging</b> submenu with "Extended HistoROM" order option Storage and visualization of measured values</li> <li>▪ Heartbeat The functionality of the device is checked on demand and the verification results are documented.</li> <li>▪ Simulation Is used to simulate measured values or output values.</li> </ul>	

Menu/parameter		User role and tasks	Content/meaning
Expert	function-oriented	<p>Tasks that require detailed knowledge of the function of the device:</p> <ul style="list-style-type: none"> <li>▪ Commissioning measurements under difficult conditions</li> <li>▪ Optimal adaptation of the measurement to difficult conditions</li> <li>▪ Detailed configuration of the communication interface</li> <li>▪ Error diagnostics in difficult cases</li> </ul>	<p>Contains all the parameters of the device and makes it possible to access these parameters directly using an access code. The structure of this menu is based on the function blocks of the device:</p> <ul style="list-style-type: none"> <li>▪ System Contains all higher-order device parameters which do not concern the measurement or the communication interface.</li> <li>▪ Sensor Configuration of the measurement.</li> <li>▪ Input Configuration of the status input.</li> <li>▪ Output Configuration of the analog current outputs as well as the pulse/frequency and switch output.</li> <li>▪ Communication Configuration of the digital communication interface and the Web server.</li> <li>▪ Submenus for function blocks (e.g. "Analog Inputs") Configuration of function blocks.</li> <li>▪ Application Configuration of the functions that go beyond the actual measurement (e.g. totalizer).</li> <li>▪ Diagnostics Error detection and analysis of process and device errors and for device simulation and Heartbeat Technology.</li> </ul>

### 8.3 Access to the operating menu via the local display

#### 8.3.1 Operational display

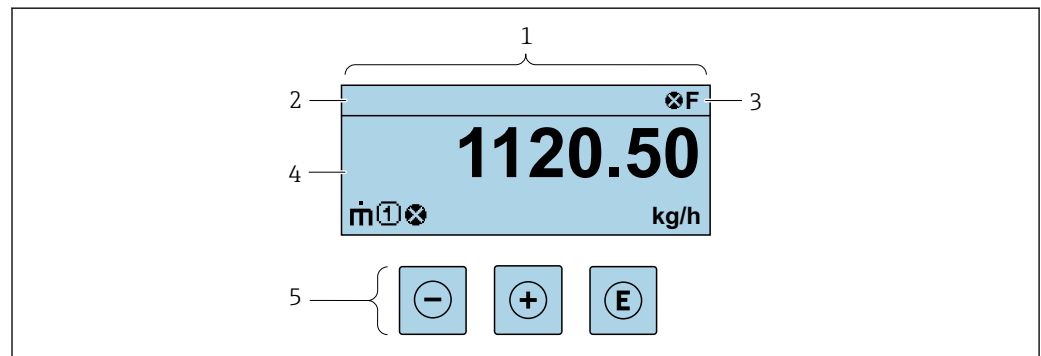

- 1 Operational display
- 2 Device tag
- 3 Status area
- 4 Display area for measured values (4-line)
- 5 Operating elements → 70

#### Status area

The following symbols appear in the status area of the operational display at the top right:

- Status signals → 167
  - **F**: Failure
  - **C**: Function check
  - **S**: Out of specification
  - **M**: Maintenance required
- Diagnostic behavior → 168
  - : Alarm
  - : Warning
  - : Locking (the device is locked via the hardware )
  - : Communication (communication via remote operation is active)

### Display area

In the display area, each measured value is prefaced by certain symbol types for further description:

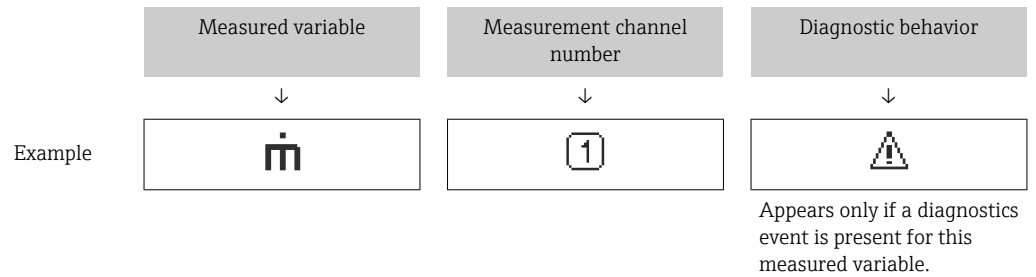

### Measured values

Symbol	Meaning
	Mass flow
	<ul style="list-style-type: none"> <li>▪ Volume flow</li> <li>▪ Corrected volume flow</li> </ul>
	<ul style="list-style-type: none"> <li>▪ Density</li> <li>▪ Reference density</li> </ul>
	Temperature
	Totalizer The measurement channel number indicates which of the three totalizers is displayed.
	Status input

### Measurement channel numbers

Symbol	Meaning
	Measurement channel 1 to 4
The measurement channel number is displayed only if more than one channel is present for the same measured variable type (e.g. Totalizer 1 to 3).	

### Diagnostic behavior

The diagnostic behavior pertains to a diagnostic event that is relevant to the displayed measured variable. For information on the symbols → 168

The number and display format of the measured values can be configured via the **Format display** parameter (→ 127).

### 8.3.2 Navigation view

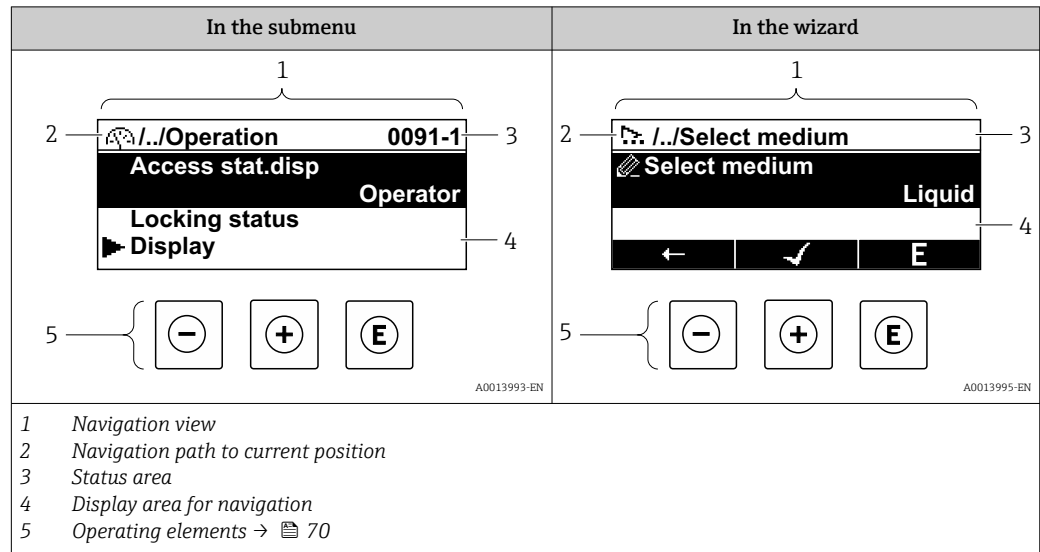

#### Navigation path

The navigation path - displayed at the top left in the navigation view - consists of the following elements:

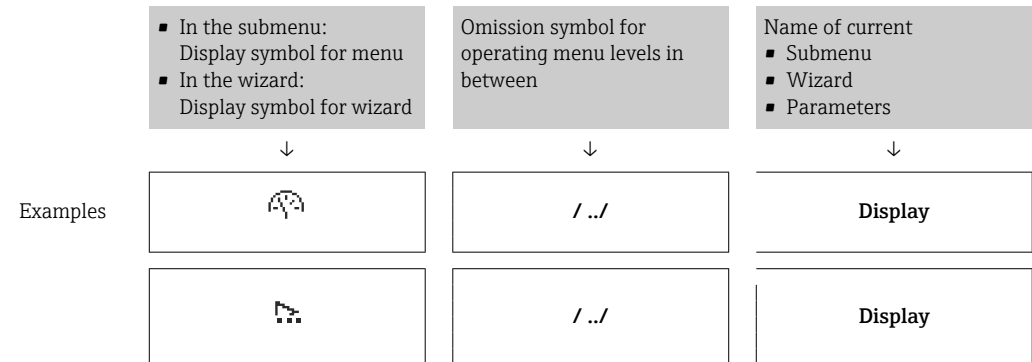

For more information about the icons in the menu, refer to the "Display area" section → 67

#### Status area





The following appears in the status area of the navigation view in the top right corner:

- In the submenu
  - The direct access code for the parameter you are navigating to (e.g. 0022-1)
  - If a diagnostic event is present, the diagnostic behavior and status signal
- In the wizard
  - If a diagnostic event is present, the diagnostic behavior and status signal





- For information on the diagnostic behavior and status signal → 167
- For information on the function and entry of the direct access code → 72

**Display area**

*Menus*

Symbol	Meaning
	<b>Operation</b> Appears: <ul style="list-style-type: none"> <li>▪ In the menu next to the "Operation" selection</li> <li>▪ At the left in the navigation path in the <b>Operation</b> menu</li> </ul>
	<b>Setup</b> Appears: <ul style="list-style-type: none"> <li>▪ In the menu next to the "Setup" selection</li> <li>▪ At the left in the navigation path in the <b>Setup</b> menu</li> </ul>
	<b>Diagnostics</b> Appears: <ul style="list-style-type: none"> <li>▪ In the menu next to the "Diagnostics" selection</li> <li>▪ At the left in the navigation path in the <b>Diagnostics</b> menu</li> </ul>
	<b>Expert</b> Appears: <ul style="list-style-type: none"> <li>▪ In the menu next to the "Expert" selection</li> <li>▪ At the left in the navigation path in the <b>Expert</b> menu</li> </ul>



*Submenus, wizards, parameters*

Symbol	Meaning
	Submenu
	Wizard
	Parameters within a wizard  No display symbol exists for parameters in submenus.

*Locking*

Symbol	Meaning
	<b>Parameter locked</b> When displayed in front of a parameter name, indicates that the parameter is locked. <ul style="list-style-type: none"> <li>▪ By a user-specific access code</li> <li>▪ By the hardware write protection switch</li> </ul>

*Wizard operation*

Symbol	Meaning
	Switches to the previous parameter.
	Confirms the parameter value and switches to the next parameter.
	Opens the editing view of the parameter.

### 8.3.3 Editing view

#### Numeric editor

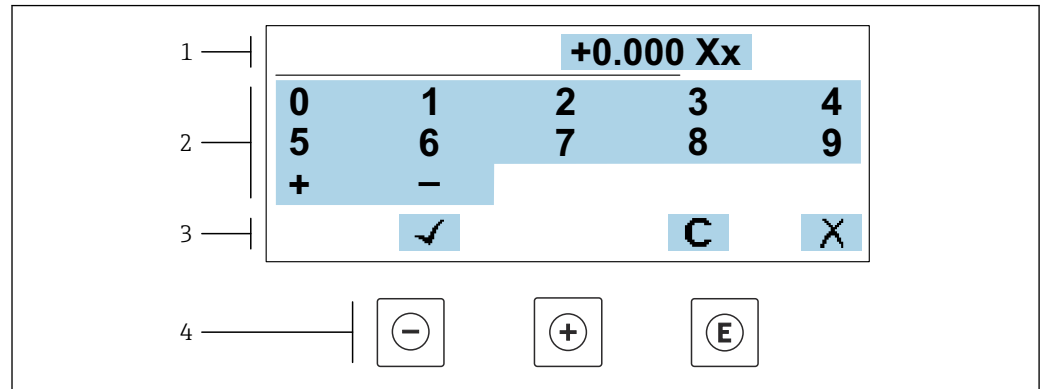

A0034250

25 For entering values in parameters (e.g. limit values)

- 1 Entry display area
- 2 Input screen
- 3 Confirm, delete or reject entry
- 4 Operating elements

#### Text editor

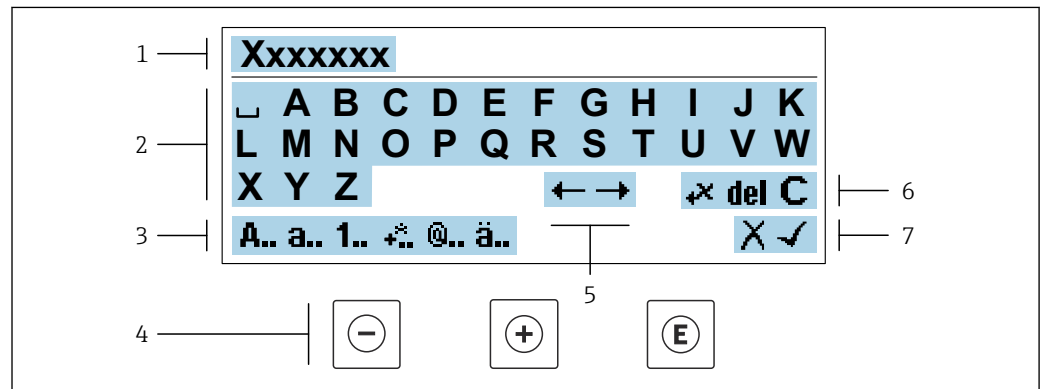

A0034114

26 For entering text in parameters (e.g. tag name)

- 1 Entry display area
- 2 Current input screen
- 3 Change input screen
- 4 Operating elements
- 5 Move entry position
- 6 Delete entry
- 7 Reject or confirm entry

#### Using the operating elements in the editing view

Operating key(s)	Meaning
	<b>Minus key</b> Move the entry position to the left.
	<b>Plus key</b> Move the entry position to the right.



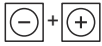



Operating key(s)	Meaning
	<b>Enter key</b> <ul style="list-style-type: none"> <li>Press the key briefly: confirm your selection.</li> <li>Press the key for 2 s: confirm the entry.</li> </ul>
	<b>Escape key combination (press keys simultaneously)</b> Close the editing view without accepting the changes.





### Input screens

Symbol	Meaning
<b>A..</b>	Upper case
<b>a..</b>	Lower case
<b>1..</b>	Numbers
<b>+..</b>	Punctuation marks and special characters: = + - * / <sup>2</sup> <sup>3</sup> ¼ ½ ¾ ( ) [ ] < > { }
<b>@..</b>	Punctuation marks and special characters: " ' ^ . , ; : ? ! % μ ° € \$ £ ¥ § @ # / \   ~ & _
<b>ä..</b>	Umlauts and accents

### Controlling data entries

Symbol	Meaning
	Move entry position
	Reject entry
	Confirm entry
	Delete character immediately to the left of the entry position
<b>del</b>	Delete character immediately to the right of the entry position
<b>C</b>	Clear all the characters entered

### 8.3.4 Operating elements

Operating key(s)	Meaning
	<p><b>Minus key</b></p> <p><i>In a menu, submenu</i> Moves the selection bar upwards in a picklist.</p> <p><i>With a Wizard</i> Confirms the parameter value and goes to the previous parameter.</p> <p><i>With a text and numeric editor</i> Move the entry position to the left.</p>
	<p><b>Plus key</b></p> <p><i>In a menu, submenu</i> Moves the selection bar downwards in a picklist.</p> <p><i>With a Wizard</i> Confirms the parameter value and goes to the next parameter.</p> <p><i>With a text and numeric editor</i> Move the entry position to the right.</p>
	<p><b>Enter key</b></p> <p><i>For operational display</i> Pressing the key briefly opens the operating menu.</p> <p><i>In a menu, submenu</i></p> <ul style="list-style-type: none"> <li>▪ Pressing the key briefly: <ul style="list-style-type: none"> <li>▪ Opens the selected menu, submenu or parameter.</li> <li>▪ Starts the wizard.</li> <li>▪ If help text is open, closes the help text of the parameter.</li> </ul> </li> <li>▪ Pressing the key for 2 s for parameter: <ul style="list-style-type: none"> <li>▪ If present, opens the help text for the function of the parameter.</li> </ul> </li> </ul> <p><i>With a Wizard</i> Opens the editing view of the parameter.</p> <p><i>With a text and numeric editor</i></p> <ul style="list-style-type: none"> <li>▪ Press the key briefly: confirm your selection.</li> <li>▪ Press the key for 2 s: confirm the entry.</li> </ul>
	<p><b>Escape key combination (press keys simultaneously)</b></p> <p><i>In a menu, submenu</i></p> <ul style="list-style-type: none"> <li>▪ Pressing the key briefly: <ul style="list-style-type: none"> <li>▪ Exits the current menu level and takes you to the next higher level.</li> <li>▪ If help text is open, closes the help text of the parameter.</li> </ul> </li> <li>▪ Pressing the key for 2 s returns you to the operational display ("home position").</li> </ul> <p><i>With a Wizard</i> Exits the wizard and takes you to the next higher level.</p> <p><i>With a text and numeric editor</i> Close the editing view without accepting the changes.</p>
	<p><b>Minus/Enter key combination (press the keys simultaneously)</b></p> <ul style="list-style-type: none"> <li>▪ If the keypad lock is active: <ul style="list-style-type: none"> <li>▪ Press the key for 3 s: deactivate the keypad lock.</li> </ul> </li> <li>▪ If the keypad lock is not active: <ul style="list-style-type: none"> <li>▪ Press the key for 3 s: the context menu opens along with the option for activating the keypad lock.</li> </ul> </li> </ul>



### 8.3.5 Opening the context menu

Using the context menu, the user can call up the following menus quickly and directly from the operational display:

- Setup
- Data backup
- Simulation



### Calling up and closing the context menu

The user is in the operational display.

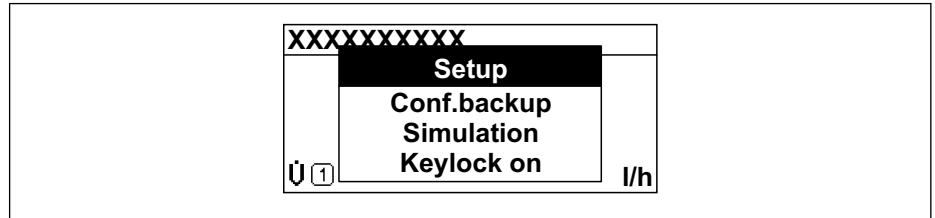

1. Press the  and  keys for longer than 3 seconds.  
↳ The context menu opens.



A0034608-EN

2. Press  +  simultaneously.  
↳ The context menu is closed and the operational display appears.

### Calling up the menu via the context menu

1. Open the context menu.
2. Press  to navigate to the desired menu.
3. Press  to confirm the selection.  
↳ The selected menu opens.

### 8.3.6 Navigating and selecting from list

Different operating elements are used to navigate through the operating menu. The navigation path is displayed on the left in the header. Icons are displayed in front of the individual menus. These icons are also shown in the header during navigation.

**i** For an explanation of the navigation view with symbols and operating elements → 66

**Example: Setting the number of displayed measured values to "2 values"**

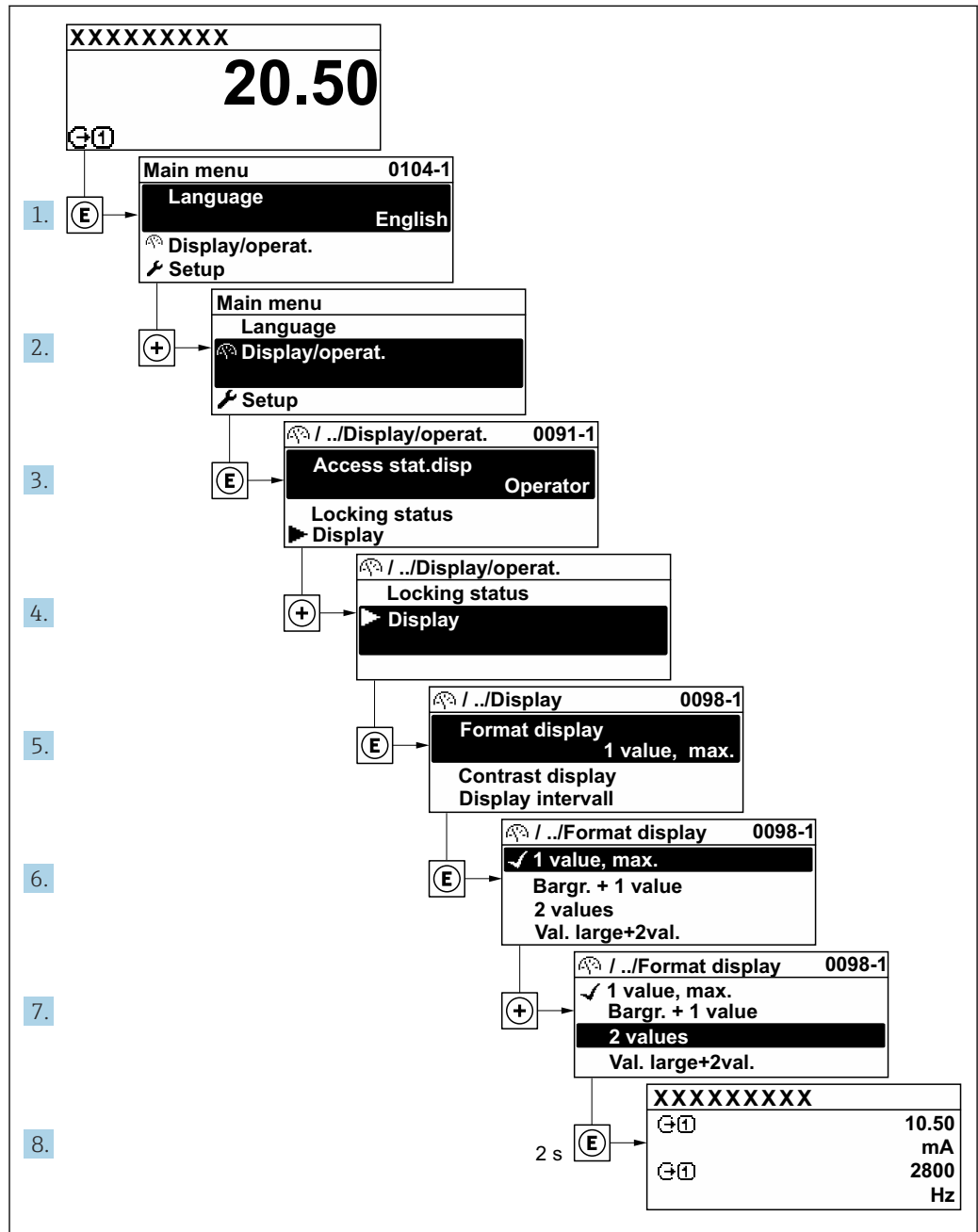

A0029562-EN

### 8.3.7 Calling the parameter directly

A parameter number is assigned to every parameter to be able to access a parameter directly via the onsite display. Entering this access code in the **Direct access** parameter calls up the desired parameter directly.

#### Navigation path

Expert → Direct access

The direct access code consists of a 5-digit number (at maximum) and the channel number, which identifies the channel of a process variable: e.g. 00914-2. In the navigation view, this appears on the right-hand side in the header of the selected parameter.

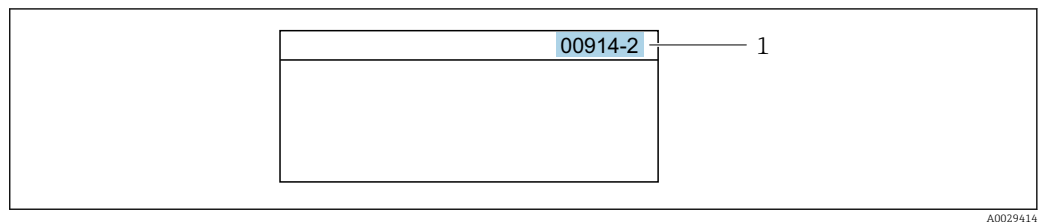

1 Direct access code

Note the following when entering the direct access code:

- The leading zeros in the direct access code do not have to be entered.  
Example: Enter "914" instead of "00914"
- If no channel number is entered, channel 1 is accessed automatically.  
Example: Enter 00914 → **Assign process variable** parameter
- If a different channel is accessed: Enter the direct access code with the corresponding channel number.  
Example: Enter 00914-2 → **Assign process variable** parameter



For the direct access codes of the individual parameters, see the "Description of Device Parameters" document for the device

### 8.3.8 Calling up help text

Help text is available for some parameters and can be called up from the navigation view. The help text provides a brief explanation of the parameter function and thereby supports swift and safe commissioning.

#### Calling up and closing the help text

The user is in the navigation view and the selection bar is on a parameter.

1. Press for 2 s.  
↳ The help text for the selected parameter opens.

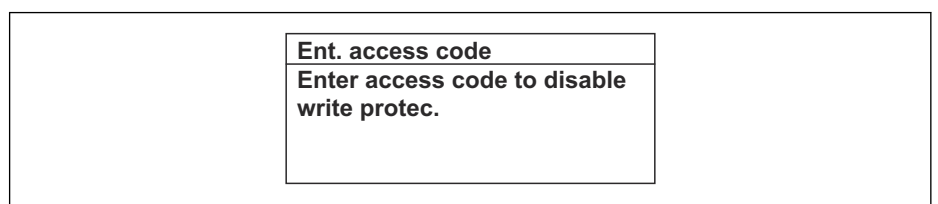

27 Example: Help text for parameter "Enter access code"

2. Press + simultaneously.  
↳ The help text is closed.

### 8.3.9 Changing the parameters

Parameters can be changed via the numeric editor or text editor.

- Numeric editor: Change values in a parameter, e.g. specifications for limit values.
- Text editor: Enter text in a parameter, e.g. tag name.

A message is displayed if the value entered is outside the permitted value range.

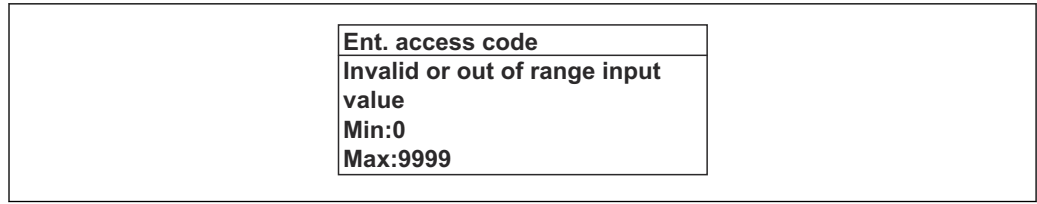

A0014049-EN

**i** For a description of the editing view - consisting of the text editor and numeric editor - with symbols → 68, for a description of the operating elements → 70

### 8.3.10 User roles and related access authorization

The two user roles "Operator" and "Maintenance" have different write access to the parameters if the customer defines a user-specific access code. This protects the device configuration via the local display from unauthorized access → 146.

#### Defining access authorization for user roles

An access code is not yet defined when the device is delivered from the factory. Access authorization (read and write access) to the device is not restricted and corresponds to the "Maintenance" user role.

- ▶ Define the access code.
  - ↳ The "Operator" user role is redefined in addition to the "Maintenance" user role. Access authorization differs for the two user roles.

#### Access authorization to parameters: "Maintenance" user role

Access code status	Read access	Write access
An access code has not yet been defined (factory setting).	✓	✓
After an access code has been defined.	✓	✓ <sup>1)</sup>

1) The user only has write access after entering the access code.

#### Access authorization to parameters: "Operator" user role

Access code status	Read access	Write access
After an access code has been defined.	✓	-- <sup>1)</sup>

1) Despite the defined access code, certain parameters can always be modified and thus are excepted from the write protection, as they do not affect the measurement. Refer to the "Write protection via access code" section

**i** The user role with which the user is currently logged on is indicated by the **Access status** parameter. Navigation path: Operation → Access status

### 8.3.11 Disabling write protection via access code

If the -symbol appears on the local display in front of a parameter, the parameter is write-protected by a user-specific access code and its value cannot be changed at the moment using local operation → 146.

Parameter write protection via local operation can be disabled by entering the user-specific access code in the **Enter access code** parameter via the respective access option.

1. After you press , the input prompt for the access code appears.

2. Enter the access code.
  - ↳ The -symbol in front of the parameters disappears; all previously write-protected parameters are now re-enabled.

### 8.3.12 Enabling and disabling the keypad lock



The keypad lock makes it possible to block access to the entire operating menu via local operation. As a result, it is no longer possible to navigate through the operating menu or change the values of individual parameters. Users can only read the measured values on the operational display.

The keypad lock is switched on and off via the context menu.

#### Switching on the keypad lock



-  The keypad lock is switched on automatically:
- If the device has not been operated via the display for > 1 minute.
  - Each time the device is restarted.

#### To activate the keylock manually:

1. The device is in the measured value display.  
Press the  and  keys for 3 seconds.
  - ↳ A context menu appears.
2. In the context menu select the **Keylock on** option.
  - ↳ The keypad lock is switched on.

-  If the user attempts to access the operating menu while the keypad lock is active, the **Keylock on** message appears.

#### Switching off the keypad lock



- ▶ The keypad lock is switched on.  
Press the  and  keys for 3 seconds.
  - ↳ The keypad lock is switched off.

## 8.4 Access to the operating menu via the Web browser

### 8.4.1 Function range

Thanks to the integrated Web server, the device can be operated and configured via a Web browser and via a service interface (CDI-RJ45) or via a WLAN interface. The structure of the operating menu is the same as for the local display. In addition to the measured values, status information on the device is also displayed and allows the user to monitor the status of the device. Furthermore the device data can be managed and the network parameters can be configured.

A device that has a WLAN interface (can be ordered as an option) is required for the WLAN connection: order code for "Display; operation", option G "4-line, illuminated; touch control + WLAN". The device acts as an Access Point and enables communication by computer or a mobile handheld terminal.

-  For additional information on the Web server, refer to the Special Documentation for the device →  267

## 8.4.2 Prerequisites



### Computer hardware

Hardware	Interface	
	CDI-RJ45	WLAN
Interface	The computer must have an RJ45 interface.	The operating unit must have a WLAN interface.
Connection	Standard Ethernet cable with RJ45 connector.	Connection via Wireless LAN.
Screen	Recommended size: ≥12" (depends on the screen resolution)	

### Computer software

Software	Interface	
	CDI-RJ45	WLAN
Recommended operating systems	<ul style="list-style-type: none"> <li>▪ Microsoft Windows 7 or higher.</li> <li>▪ Mobile operating systems:                             <ul style="list-style-type: none"> <li>▪ iOS</li> <li>▪ Android</li> </ul> </li> </ul> <p> Microsoft Windows XP is supported.</p>	
Web browsers supported	<ul style="list-style-type: none"> <li>▪ Microsoft Internet Explorer 8 or higher</li> <li>▪ Microsoft Edge</li> <li>▪ Mozilla Firefox</li> <li>▪ Google Chrome</li> <li>▪ Safari</li> </ul>	



### Computer settings

Settings	Interface	
	CDI-RJ45	WLAN
User rights	Appropriate user rights (e.g. administrator rights) for TCP/IP and proxy server settings are necessary (for adjusting the IP address, subnet mask etc.).	
Proxy server settings of the Web browser	The Web browser setting <i>Use a Proxy Server for Your LAN</i> must be <b>deselected</b> .	
JavaScript	<p>JavaScript must be enabled.</p> <p> If JavaScript cannot be enabled: enter <code>http://192.168.1.212/basic.html</code> in the address line of the Web browser. A fully functional but simplified version of the operating menu structure starts in the Web browser.</p> <p> When installing a new firmware version: To enable correct data display, clear the temporary memory (cache) of the Web browser under <b>Internet options</b>.</p>	
Network connections	Only the active network connections to the measuring device should be used.	
	Switch off all other network connections such as WLAN.	Switch off all other network connections.



 In the event of connection problems: →  162



*Measuring device: Via CDI-RJ45 service interface*

Device	CDI-RJ45 service interface
Measuring device	The measuring device has an RJ45 interface.
Web server	Web server must be enabled; factory setting: ON  For information on enabling the Web server →  81

*Measuring device: via WLAN interface*

Device	WLAN interface
Measuring device	The measuring device has a WLAN antenna: <ul style="list-style-type: none"> <li>▪ Transmitter with integrated WLAN antenna</li> <li>▪ Transmitter with external WLAN antenna</li> </ul>
Web server	Web server and WLAN must be enabled; factory setting: ON  For information on enabling the Web server →  81

**8.4.3 Establishing a connection****Via service interface (CDI-RJ45)***Preparing the measuring device**Proline 500 – digital*

1. Loosen the 4 fixing screws on the housing cover.
2. Open the housing cover.
3. The location of the connection socket depends on the measuring device and the communication protocol:  
Connect the computer to the RJ45 connector via the standard Ethernet connecting cable .

*Proline 500*

1. Depending on the housing version:  
Release the securing clamp or securing screw of the housing cover.
2. Depending on the housing version:  
Unscrew or open the housing cover.
3. The location of the connection socket depends on the measuring device and the communication protocol:  
Connect the computer to the RJ45 connector via the standard Ethernet connecting cable .

*Configuring the Internet protocol of the computer*

The following information refers to the default Ethernet settings of the device.

IP address of the device: 192.168.1.212 (factory setting)

1. Switch on the measuring device.
2. Connect to the computer using a cable →  82.
3. If a 2nd network card is not used, close all the applications on the notebook.
  - ↳ Applications requiring Internet or a network, such as e-mail, SAP applications, Internet or Windows Explorer.
4. Close any open Internet browsers.
5. Configure the properties of the Internet protocol (TCP/IP) as defined in the table:

<b>IP address</b>	192.168.1.XXX; for XXX all numerical sequences except: 0, 212 and 255 → e.g. 192.168.1.213
<b>Subnet mask</b>	255.255.255.0
<b>Default gateway</b>	192.168.1.212 or leave cells empty

### Via WLAN interface

*Configuring the Internet protocol of the mobile terminal*

#### NOTICE

**If the WLAN connection is lost during the configuration, settings made may be lost.**

- ▶ Make sure that the WLAN connection is not disconnected while configuring the device.

#### NOTICE

**In principle, avoid simultaneous access to the measuring device via the service interface (CDI-RJ45) and the WLAN interface from the same mobile terminal. This could cause a network conflict.**

- ▶ Only activate one service interface (CDI-RJ45 service interface or WLAN interface).
- ▶ If simultaneous communication is necessary: configure different IP address ranges, e.g. 192.168.0.1 (WLAN interface) and 192.168.1.212 (CDI-RJ45 service interface).

*Preparing the mobile terminal*

- ▶ Enable WLAN reception on the mobile terminal.

*Establishing a connection from the mobile terminal to the measuring device*

1. In the WLAN settings of the mobile terminal:  
Select the measuring device using the SSID (e.g. EH\_Promass\_500\_A802000).
2. If necessary, select the WPA2 encryption method.
3. Enter the password: serial number of the measuring device ex-works (e.g. L100A802000).  
↳ LED on display module flashes: it is now possible to operate the measuring device with the Web browser, FieldCare or DeviceCare.

 The serial number can be found on the nameplate.

 To ensure the safe and swift assignment of the WLAN network to the measuring point, it is advisable to change the SSID name. It should be possible to clearly assign the new SSID name to the measuring point (e.g. tag name) because it is displayed as the WLAN network.

*Disconnecting*

- ▶ After configuring the device:  
Terminate the WLAN connection between the operating unit and measuring device.

### Starting the Web browser

1. Start the Web browser on the computer.

2. Enter the IP address of the Web server in the address line of the Web browser:  
192.168.1.212  
↳ The login page appears.

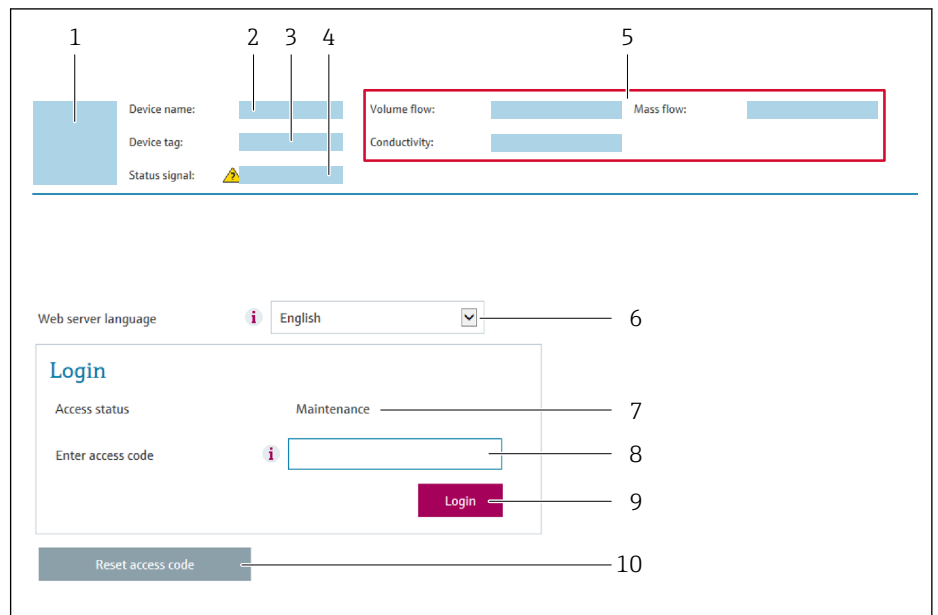

A0029417

- 1 Picture of device
- 2 Device name
- 3 Device tag
- 4 Status signal
- 5 Current measured values
- 6 Operating language
- 7 User role
- 8 Access code
- 9 Login
- 10 Reset access code (→ 143)

**i** If a login page does not appear, or if the page is incomplete → 162

### 8.4.4 Logging on

1. Select the preferred operating language for the Web browser.
2. Enter the user-specific access code.
3. Press **OK** to confirm your entry.

<b>Access code</b>	0000 (factory setting); can be changed by customer
--------------------	--

**i** If no action is performed for 10 minutes, the Web browser automatically returns to the login page.

### 8.4.5 User interface

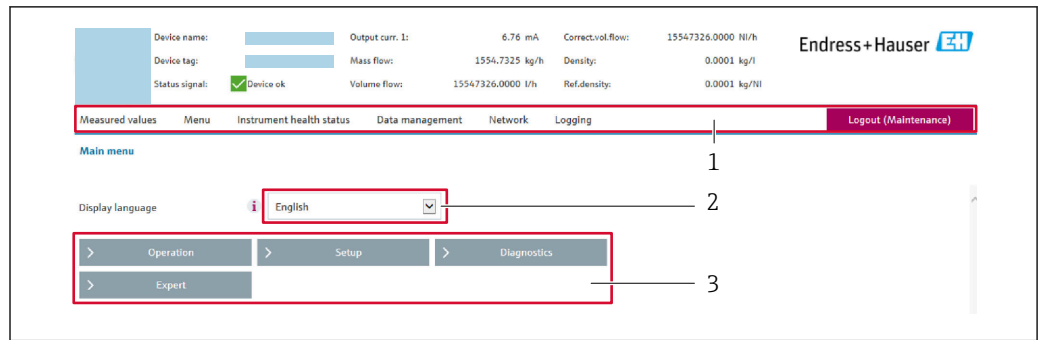

A0029418

- 1 Function row
- 2 Local display language
- 3 Navigation area

#### Header

The following information appears in the header:

- Device name
- Device tag
- Device status with status signal → 170
- Current measured values

#### Function row

Functions	Meaning
Measured values	Displays the measured values of the measuring device
Menu	<ul style="list-style-type: none"> <li>■ Access to the operating menu from the measuring device</li> <li>■ The structure of the operating menu is the same as for the local display</li> </ul> For detailed information on the structure of the operating menu, see the Operating Instructions for the measuring device
Device status	Displays the diagnostic messages currently pending, listed in order of priority
Data management	Data exchange between PC and measuring device: <ul style="list-style-type: none"> <li>■ Device configuration:               <ul style="list-style-type: none"> <li>■ Load settings from the device (XML format, save configuration)</li> <li>■ Save settings to the device (XML format, restore configuration)</li> </ul> </li> <li>■ Logbook - Export Event logbook (.csv file)</li> <li>■ Documents - Export documents:               <ul style="list-style-type: none"> <li>■ Export backup data record (.csv file, create documentation of the measuring point configuration)</li> <li>■ Verification report (PDF file, only available with the "Heartbeat Verification" application package)</li> </ul> </li> <li>■ File for system integration - If using fieldbuses, upload device drivers for system integration from the measuring device: PROFIBUS DP: GSD file</li> <li>■ Firmware update - Flashing a firmware version</li> </ul>
Network configuration	Configuration and checking of all the parameters required for establishing the connection to the measuring device: <ul style="list-style-type: none"> <li>■ Network settings (e.g. IP address, MAC address)</li> <li>■ Device information (e.g. serial number, firmware version)</li> </ul>
Logout	End the operation and call up the login page

### Navigation area

If a function is selected in the function bar, the submenus of the function open in the navigation area. The user can now navigate through the menu structure.

### Working area

Depending on the selected function and the related submenus, various actions can be performed in this area:

- Configuring parameters
- Reading measured values
- Calling up help text
- Starting an upload/download

## 8.4.6 Disabling the Web server

The Web server of the measuring device can be switched on and off as required using the **Web server functionality** parameter.

### Navigation

"Expert" menu → Communication → Web server

### Parameter overview with brief description

Parameter	Description	Selection
Web server functionality	Switch the Web server on and off.	<ul style="list-style-type: none"> <li>▪ Off</li> <li>▪ HTML Off</li> <li>▪ On</li> </ul>

### Function scope of the "Web server functionality" parameter

Option	Description
Off	<ul style="list-style-type: none"> <li>▪ The web server is completely disabled.</li> <li>▪ Port 80 is locked.</li> </ul>
On	<ul style="list-style-type: none"> <li>▪ The complete functionality of the web server is available.</li> <li>▪ JavaScript is used.</li> <li>▪ The password is transferred in an encrypted state.</li> <li>▪ Any change to the password is also transferred in an encrypted state.</li> </ul>

### Enabling the Web server

If the Web server is disabled it can only be re-enabled with the **Web server functionality** parameter via the following operating options:

- Via local display
- Via Bedientool "FieldCare"
- Via "DeviceCare" operating tool

## 8.4.7 Logging out

 Before logging out, perform a data backup via the **Data management** function (upload configuration from device) if necessary.

1. Select the **Logout** entry in the function row.  
↳ The home page with the Login box appears.
2. Close the Web browser.
3. If no longer needed:  
Reset modified properties of the Internet protocol (TCP/IP) →  77.

## 8.5 Access to the operating menu via the operating tool

The structure of the operating menu in the operating tools is the same as for operation via the local display.

### 8.5.1 Connecting the operating tool

#### Via PROFIBUS DP network

This communication interface is available in device versions with PROFIBUS DP.

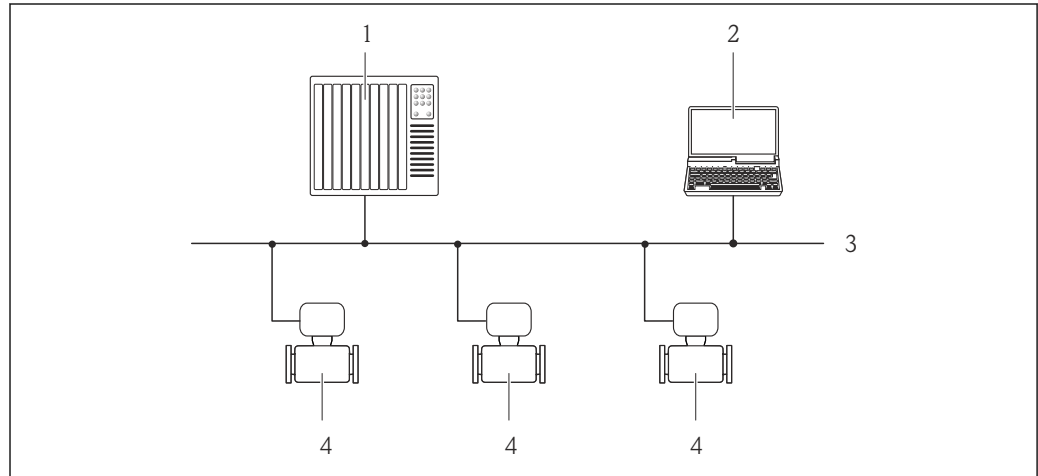

28 Options for remote operation via PROFIBUS DP network

- 1 Automation system
- 2 Computer with PROFIBUS network card
- 3 PROFIBUS DP network
- 4 Measuring device

#### Service interface

##### Via service interface (CDI-RJ45)

A point-to-point connection can be established to configure the device onsite. With the housing open, the connection is established directly via the service interface (CDI-RJ45) of the device.

- i** An adapter for RJ45 and the M12 connector is optionally available:  
Order code for "Accessories", option **NB**: "Adapter RJ45 M12 (service interface)"

The adapter connects the service interface (CDI-RJ45) to an M12 connector mounted in the cable entry. Therefore the connection to the service interface can be established via an M12 connector without opening the device.

*Proline 500 – digital transmitter*

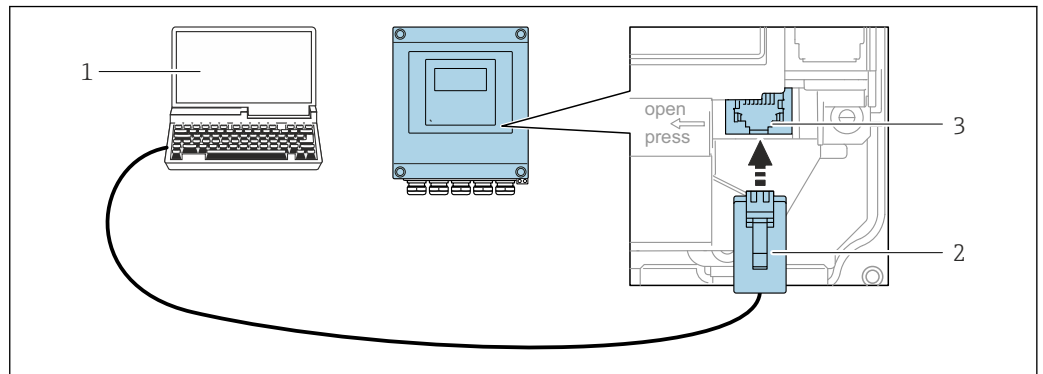

A0029163

29 Connection via service interface (CDI-RJ45)

- 1 Computer with Web browser (e.g. Microsoft Internet Explorer, Microsoft Edge) for accessing the integrated device Web server or with "FieldCare", "DeviceCare" operating tool with COM DTM "CDI Communication TCP/IP"
- 2 Standard Ethernet connecting cable with RJ45 connector
- 3 Service interface (CDI-RJ45) of the measuring device with access to the integrated Web server

*Proline 500 transmitter*

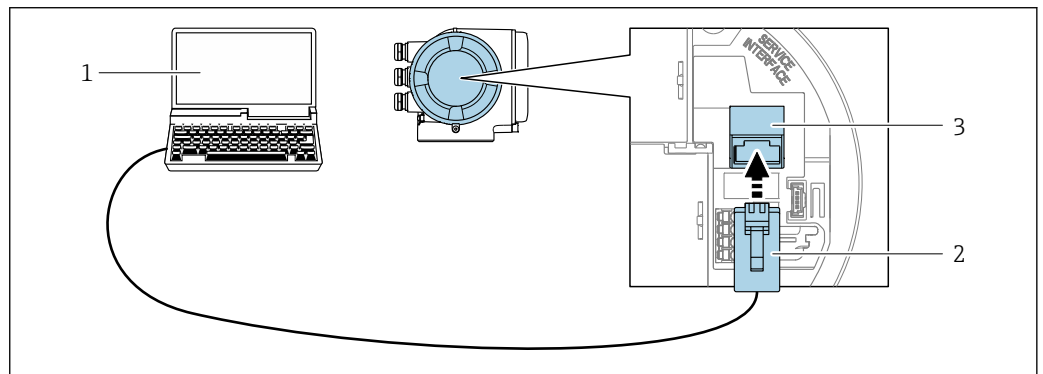

A0027563

30 Connection via service interface (CDI-RJ45)

- 1 Computer with Web browser (e.g. Microsoft Internet Explorer, Microsoft Edge) for accessing the integrated device Web server or with "FieldCare", "DeviceCare" operating tool with COM DTM "CDI Communication TCP/IP"
- 2 Standard Ethernet connecting cable with RJ45 connector
- 3 Service interface (CDI-RJ45) of the measuring device with access to the integrated Web server

*Via WLAN interface*

The optional WLAN interface is available on the following device version:

Order code for "Display; operation", option G "4-line, illuminated; touch control + WLAN"

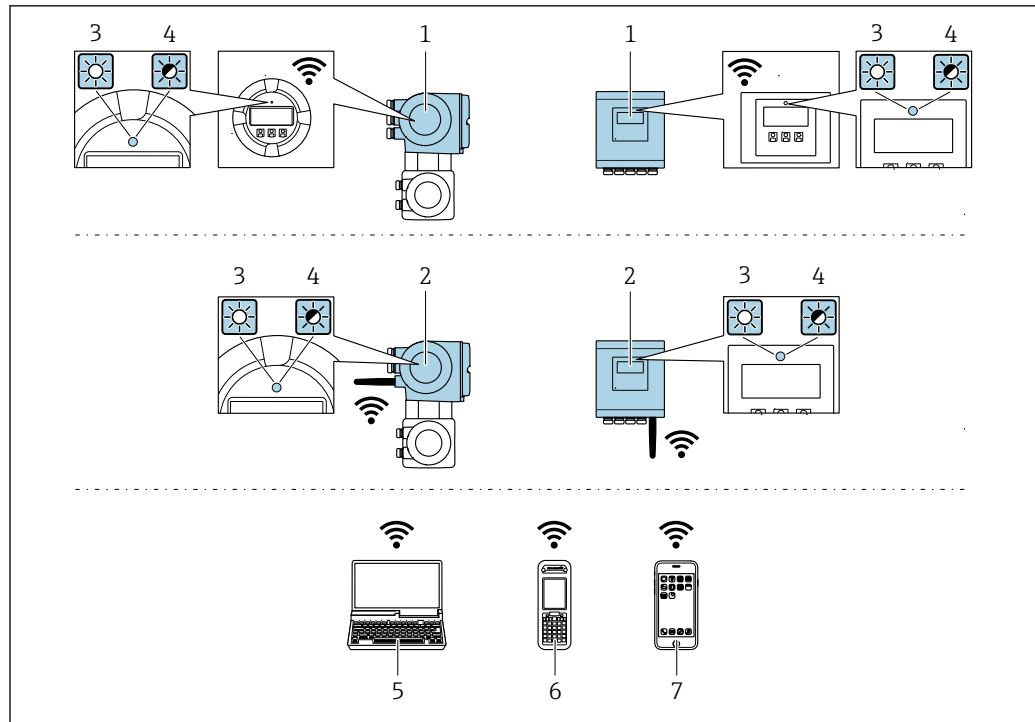

A0034569

- 1 Transmitter with integrated WLAN antenna
- 2 Transmitter with external WLAN antenna
- 3 LED lit constantly: WLAN reception is enabled on measuring device
- 4 LED flashing: WLAN connection established between operating unit and measuring device
- 5 Computer with WLAN interface and Web browser (e.g. Microsoft Internet Explorer, Microsoft Edge) for accessing the integrated device Web server or with operating tool (e.g. FieldCare, DeviceCare)
- 6 Mobile handheld terminal with WLAN interface and Web browser (e.g. Microsoft Internet Explorer, Microsoft Edge) for accessing the integrated device Web server or operating tool (e.g. FieldCare, DeviceCare)
- 7 Smart phone or tablet (e.g. Field Xpert SMT70)

Encryption	WPA2-PSK AES-128 (in accordance with IEEE 802.11i)
Configurable WLAN channels	1 to 11
Degree of protection	IP67
Available antennas	<ul style="list-style-type: none"> <li>▪ Internal antenna</li> <li>▪ External antenna (optional) In the event of poor transmission/reception conditions at the place of installation.</li> </ul> <p><b>i</b> Only one antenna active in each case!</p>
Range	<ul style="list-style-type: none"> <li>▪ Internal antenna: typically 10 m (32 ft)</li> <li>▪ External antenna: typically 50 m (164 ft)</li> </ul>
Materials (external antenna)	<ul style="list-style-type: none"> <li>▪ Antenna: ASA plastic (acrylic ester-styrene-acrylonitrile) and nickel-plated brass</li> <li>▪ Adapter: Stainless steel and nickel-plated brass</li> <li>▪ Cable: Polyethylene</li> <li>▪ Connector: Nickel-plated brass</li> <li>▪ Angle bracket: Stainless steel</li> </ul>

*Configuring the Internet protocol of the mobile terminal*

**NOTICE**

**If the WLAN connection is lost during the configuration, settings made may be lost.**

- Make sure that the WLAN connection is not disconnected while configuring the device.



**NOTICE**

**In principle, avoid simultaneous access to the measuring device via the service interface (CDI-RJ45) and the WLAN interface from the same mobile terminal. This could cause a network conflict.**

- ▶ Only activate one service interface (CDI-RJ45 service interface or WLAN interface).
- ▶ If simultaneous communication is necessary: configure different IP address ranges, e.g. 192.168.0.1 (WLAN interface) and 192.168.1.212 (CDI-RJ45 service interface).

*Preparing the mobile terminal*

- ▶ Enable WLAN reception on the mobile terminal.

*Establishing a connection from the mobile terminal to the measuring device*

1. In the WLAN settings of the mobile terminal:  
Select the measuring device using the SSID (e.g. EH\_Promass\_500\_A802000).
2. If necessary, select the WPA2 encryption method.
3. Enter the password: serial number of the measuring device ex-works (e.g. L100A802000).
  - ↳ LED on display module flashes: it is now possible to operate the measuring device with the Web browser, FieldCare or DeviceCare.

 The serial number can be found on the nameplate.

 To ensure the safe and swift assignment of the WLAN network to the measuring point, it is advisable to change the SSID name. It should be possible to clearly assign the new SSID name to the measuring point (e.g. tag name) because it is displayed as the WLAN network.

*Disconnecting*



- ▶ After configuring the device:  
Terminate the WLAN connection between the operating unit and measuring device.

## 8.5.2 FieldCare

### Function scope

FDT-based plant asset management tool from Endress+Hauser. It can configure all smart field devices in a system and helps you manage them. By using the status information, it is also a simple but effective way of checking their status and condition.

Access is via:

- CDI-RJ45 service interface →  82
- WLAN interface →  83

Typical functions:

- Configuring parameters of transmitters
- Loading and saving device data (upload/download)
- Documentation of the measuring point
- Visualization of the measured value memory (line recorder) and event logbook

 For additional information about FieldCare, see Operating Instructions BA00027S and BA00059S

### Source for device description files

See information →  88

### Establishing a connection

1. Start FieldCare and launch the project.

2. In the network: Add a device.  
↳ The **Add device** window opens.
3. Select the **CDI Communication TCP/IP** option from the list and press **OK** to confirm.
4. Right-click **CDI Communication TCP/IP** and select the **Add device** option in the context menu that opens.
5. Select the desired device from the list and press **OK** to confirm.  
↳ The **CDI Communication TCP/IP (Configuration)** window opens.
6. Enter the device address in the **IP address** field: 192.168.1.212 and press **Enter** to confirm.
7. Establish the online connection to the device.

 For additional information, see Operating Instructions BA00027S and BA00059S

### User interface

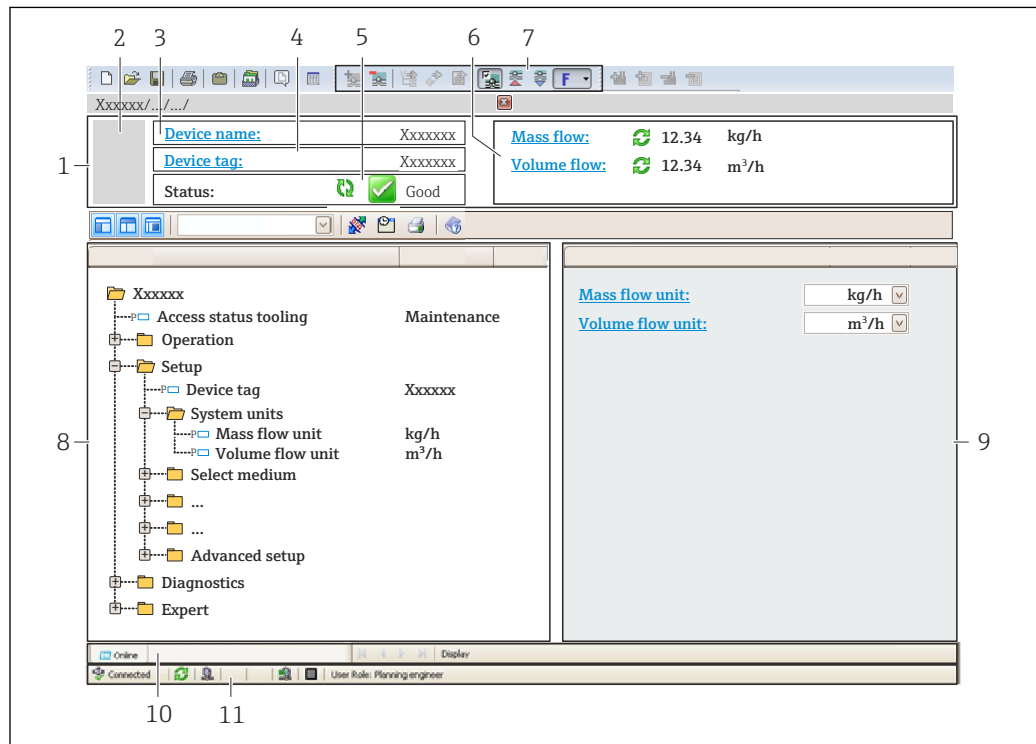

A0021051-EN

- 1 Header
- 2 Picture of device
- 3 Device name
- 4 Device tag
- 5 Status area with status signal →  170
- 6 Display area for current measured values
- 7 Edit toolbar with additional functions such as save/restore, event list and create documentation
- 8 Navigation area with operating menu structure
- 9 Working area
- 10 Range of action
- 11 Status area

### 8.5.3 DeviceCare

#### Function scope

Tool to connect and configure Endress+Hauser field devices.

The fastest way to configure Endress+Hauser field devices is with the dedicated "DeviceCare" tool. Together with the device type managers (DTMs) it presents a convenient, comprehensive solution.



For details, see Innovation Brochure IN01047S

### Source for device description files

See information →  88

## 9 System integration

### 9.1 Overview of device description files

#### 9.1.1 Current version data for the device

Firmware version	01.00.zz	<ul style="list-style-type: none"> <li>▪ On the title page of the Operating instructions</li> <li>▪ On the transmitter nameplate</li> <li>▪ Firmware version Diagnostics → Device information → Firmware version</li> </ul>
Release date of firmware version	06.2018	---
Manufacturer ID	0x11	Manufacturer ID Diagnostics → Device information → Manufacturer ID
Device type ID	0x156F	Device type Diagnostics → Device information → Device type
Profile version	3.02	---

 For an overview of the different firmware versions for the device →  232

#### 9.1.2 Operating tools

The suitable device description file for the individual operating tools is listed in the table below, along with information on where the file can be acquired.

Operating tool via PROFIBUS protocol	Sources for obtaining device descriptions
FieldCare	<ul style="list-style-type: none"> <li>▪ <a href="http://www.endress.com">www.endress.com</a> → Download Area</li> <li>▪ CD-ROM (contact Endress+Hauser)</li> <li>▪ DVD (contact Endress+Hauser)</li> </ul>
DeviceCare	<ul style="list-style-type: none"> <li>▪ <a href="http://www.endress.com">www.endress.com</a> → Download Area</li> <li>▪ CD-ROM (contact Endress+Hauser)</li> <li>▪ DVD (contact Endress+Hauser)</li> </ul>

## 9.2 Device master file (GSD)

In order to integrate field devices into a bus system, the PROFIBUS system needs a description of the device parameters, such as output data, input data, data format, data volume and supported transmission rate.

These data are available in the device master file (GSD) which is provided to the PROFIBUS Master when the communication system is commissioned. In addition device bit maps, which appear as icons in the network structure, can also be integrated.

With the Profile 3.02 device master file (GSD) it is possible to exchange field devices made by different manufacturers without having to reconfigure.

Generally speaking, it is possible to use two different GSDs with Profile 3.02 and higher: the manufacturer-specific GSD and the Profile GSD.

-  ▪ Before configuring, the user must decide which GSD should be used to operate the system.
- The setting can be changed via a Class 2 master.

### 9.2.1 Manufacturer-specific GSD

This GSD guarantees the unrestricted functionality of the measuring device. Device-specific process parameters and functions are therefore available.

Manufacturer-specific GSD	ID number	File name
PROFIBUS DP	0x156F	EH3x156F.gsd

The fact that the manufacturer-specific GSD should be used is specified in the **Ident number selector** parameter by selecting the **Manufacturer** option.

 Where to acquire the manufacturer-specific GSD:  
[www.endress.com](http://www.endress.com) → Downloads area

### 9.2.2 Profile GSD

Differs in terms of the number of Analog Input blocks (AI) and the measured values. If a system is configured with a Profile GSD, it is possible to exchange devices made by different manufacturers. However, it is essential to ensure that the order of the cyclic process values is correct.

ID number	Supported blocks	Supported channels
0x9740	<ul style="list-style-type: none"> <li>▪ 1 Analog Input</li> <li>▪ 1 Totalizer</li> </ul>	<ul style="list-style-type: none"> <li>▪ Channel Analog Input: volume flow</li> <li>▪ Channel totalizer: volume flow</li> </ul>
0x9741	<ul style="list-style-type: none"> <li>▪ 2 Analog Input</li> <li>▪ 1 Totalizer</li> </ul>	<ul style="list-style-type: none"> <li>▪ Channel Analog Input 1: volume flow</li> <li>▪ Channel Analog Input 2: mass flow</li> <li>▪ Channel totalizer: volume flow</li> </ul>
0x9742	<ul style="list-style-type: none"> <li>▪ 3 Analog Input</li> <li>▪ 1 Totalizer</li> </ul>	<ul style="list-style-type: none"> <li>▪ Channel Analog Input 1: volume flow</li> <li>▪ Channel Analog Input 2: mass flow</li> <li>▪ Channel Analog Input 3: corrected volume flow</li> <li>▪ Channel totalizer: volume flow</li> </ul>

The Profile GSD that is to be used is specified in the **Ident number selector** parameter by selecting the **Profile 0x9740** option, **Profile 0x9741** option or **Profile 0x9742** option.

## 9.3 Compatibility with earlier model

If the device is replaced, the Promass 500 measuring device supports the compatibility of the cyclic data with previous models. It is not necessary to adjust the engineering parameters of the PROFIBUS network with the Promass 500 GSD file.

Previous model:

Promass 83 PROFIBUS DP

- ID No.: 1529 (hex)
- Extended GSD file: EH3x1529.gsd
- Standard GSD file: EH3\_1529.gsd

### 9.3.1 Automatic identification (factory setting)

The Promass 500 PROFIBUS DP automatically recognizes the measuring device configured in the automation system (Promass 83 PROFIBUS DP) and makes the same input and output data and measured value status information available for cyclic data exchange.

Automatic identification is set in the **Ident number selector** parameter using the **Automatic mode** option (factory setting).

### 9.3.2 Manual setting

The manual setting is made in the **Ident number selector** parameter via the **Promass 83 (0x1529)** option.

Afterwards the Promass 500 PROFIBUS DP makes the same input and output data and measured value status information →  172 available for cyclic data exchange.

- If the Promass 500 PROFIBUS DP is acyclically configured via an operating program (Class 2 master), access is directly via the block structure or the parameters of the measuring device.
- If parameters have been changed in the device to be replaced (Promass 83 PROFIBUS DP) (parameter setting no longer corresponds to the original factory setting), these parameters must be changed accordingly in the new Promass 500 PROFIBUS DP being used via an operating program (Class 2 master).

#### Example

The assignment setting for low flow cut off has been changed from mass flow (factory setting) to corrected volume flow in a Promass 83 PROFIBUS DP currently in operation. This device is now replaced by a Promass 500 PROFIBUS DP.

After replacing the device, the assignment for the low flow cut off must also be changed manually in the Promass 500 PROFIBUS DP, i.e. to corrected volume flow, to ensure the measuring device behaves identically.

### 9.3.3 Replacing the measuring devices without changing the GSD file or restarting the controller

In the procedure described below, the device can be replaced without interrupting ongoing operation or restarting the controller. However with this procedure the measuring device is not fully integrated!

1. Replace the measuring device Promass 83 PROFIBUS DP by the Promass 500 PROFIBUS DP.
2. Set the device address: The same device address that was set for Promass 83 PROFIBUS DP and is configured in the automation system must be used.
3. Connect the measuring device Promass 500 PROFIBUS DP.

If the factory setting had been changed on the replaced device (Promass 83 PROFIBUS DP), the following settings may need to be changed:

1. Configuration of the application-specific parameters.
2. Choice of process variables to be transmitted via the **Channel** parameter in the Analog Input or Totalizer function block.
3. Setting of the units for the process variables.

## 9.4 Using the GSD modules of the previous model

In the compatibility mode, all the modules already configured in the automation system are generally supported during cyclic data transmission. However, Promass 500 does not perform further processing for the following modules, i.e. the function is not executed:

- DISPLAY\_VALUE
- BATCHING\_QUANTITY
- BATCHING\_FIX\_COMP\_QUANTITY

If the device is replaced, the measuring device Promass 500 supports the compatibility of the cyclic data with previous models. It is not necessary to adjust the engineering parameters of the PROFIBUS network with the Promass 500 GSD file.

### 9.4.1 Using the CONTROL\_BLOCK module in the previous model

If the CONTROL\_BLOCK module is used in the previous model, the control variables are processed further if relevant functionalities can be assigned for the Promass 500.

The functions are supported as follows depending on the previous model:

*Previous model: Promass 83 PROFIBUS DP*

Control variable	Function	Support
0 → 2	Positive zero return: ON	Yes
0 → 3	Positive zero return: OFF	Yes
0 → 4	Zero point adjustment: START	Yes
0 → 8	Measuring mode: UNIDIRECTIONAL	No
0 → 9	Measuring mode: BIDIRECTIONAL	<p><b>Cause:</b> The Profile Transducer Block Flow is no longer supported.</p> <p><b>To continue to use the functionality:</b> Use the <b>Totalizer operation mode</b> parameter in the Totalizer function block.</p>
0 → 24	UNIT TO BUS	<p>No</p> <p><b>Cause:</b> Functionality is no longer required as the unit is adopted automatically.</p>
0 → 25	Advanced diagnostics – Warning mode: ON	No
0 → 26	Advanced diagnostics – Warning mode: OFF	<p><b>To continue to use the functionality:</b> The functionalities are offered in the "Heartbeat Technology" application package.</p>
0 → 30 to 43	Additional functions: Batching	No
0 → 50	Relay output 1: ON	Yes, terminals 24/25 (I/O 2)
0 → 51	Relay output 1: OFF	
0 → 55	Relay output 2: ON	Yes, terminals 22/23 (I/O 3)
0 → 56	Relay output 2: OFF	
0 → 70 to 78	Additional functions: Advanced diagnostics	<p>No</p> <p><b>To continue to use the functionality:</b> The functionalities are offered in the "Heartbeat Technology" application package.</p>

## 9.5 Cyclic data transmission

Cyclic data transmission when using the device master file (GSD).

### 9.5.1 Block model

The block model shows which input and output data the measuring device makes available for cyclic data exchange. Cyclic data exchange takes place with a PROFIBUS master (Class 1), e.g. a control system.

Measuring device			Control system
<b>Flow Block</b>	Analog Input block 1 to 8 → 93	Output value AI	→
		Output value TOTAL	→
	Totalizer block 1 to 3 → 94	Controller SETTOT	←
		Configuration MODETOT	←
	Analog Output block 1 to 5 → 96	Input values AO	←
	Discrete Input block 1 to 2 → 96	Output values DI	→
	Discrete Output block 1 to 7 → 97	Input values DO	←
			<b>PROFIBUS DP</b>

#### Defined order of modules

The measuring device works as a modular PROFIBUS slave. In contrast to a compact slave, a modular slave has a variable design and consists of several individual modules. The device master file (GSD) contains a description of the individual modules (input and output data) along with their individual properties.

The modules are permanently assigned to the slots, i.e. when configuring the modules, the order and the arrangement of the modules must be respected.

Slot	Module	Function block
1 to 8	AI	Analog Input block 1 to 8
9	TOTAL or SETTOT_TOTAL or SETTOT_MODETOT_TOTAL	Totalizer block 1
10		Totalizer block 2
11		Totalizer block 3
12 to 16	AO	Analog Output block 1 to 5
17 to 18	DI	Discrete Input block 1 to 2
19 to 25	DO	Discrete Output block 1 to 7

To optimize the data throughput rate of the PROFIBUS network, it is advisable to only configure modules that are processed in the PROFIBUS master system. If this results in gaps between the configured modules, these gaps must be assigned to the EMPTY\_MODULE.

### 9.5.2 Description of the modules

The data structure is described from the perspective of the PROFIBUS master:

- Input data: Are sent from the measuring device to the PROFIBUS master.
- Output data: Are sent from the PROFIBUS master to the measuring device.



### AI module (Analog Input)

Transmit an input variable from the measuring device to the PROFIBUS master (Class 1).

The selected input variable, along with the status, is cyclically transmitted to the PROFIBUS Master (Class 1) via the AI module. The input variable is depicted in the first four bytes in the form of a floating point number as per the IEEE 754 standard. The fifth byte contains standardized status information pertaining to the input variable.

Eight Analog Input blocks are available (slot 1 to 8).

*Selection: input variable*

Input variable
Mass flow
Volume flow
Corrected volume flow
Density
Reference density
Temperature
Electronic temperature
Oscillation frequency 0
Frequency fluctuation 0
Oscillation damping 0
Tube damping fluctuation 0
Signal asymmetry
Exciter current 0
Concentration <sup>1)</sup>
Target mass flow <sup>1)</sup>
Carrier mass flow <sup>1)</sup>
Target volume flow <sup>1)</sup>
Carrier volume flow <sup>1)</sup>
Target corrected volume flow <sup>1)</sup>
Carrier corrected volume flow <sup>1)</sup>
Carrier tube temperature <sup>2)</sup>
Oscillation frequency 1 <sup>2)</sup>
Oscillation amplitude 0 <sup>2)</sup>
Oscillation amplitude 1 <sup>2)</sup>
Frequency fluctuation 1 <sup>2)</sup>
Oscillation damping 1 <sup>2)</sup>
Tube damping fluctuation 1 <sup>2)</sup>
Excitation current 1 <sup>2)</sup>
HBSI <sup>2)</sup>
Current input 1
Current input 2
Current input 3

1) Only available with the Concentration application package

2) Only available with the Heartbeat Verification application package

*Factory setting*

Function block	Factory setting
AI 1	Mass flow
AI 2	Volume flow
AI 3	Corrected volume flow
AI 4	Density
AI 5	Mass flow
AI 6	Temperature
AI 7	Mass flow
AI 8	Mass flow

*Data structure**Input data of Analog Input*

Byte 1	Byte 2	Byte 3	Byte 4	Byte 5
Measured value: floating point number (IEEE 754)				Status

**TOTAL module**

Transmit a totalizer value from the measuring device to the PROFIBUS master (Class 1).

A selected totalizer value, along with the status, is cyclically transmitted to a PROFIBUS Master (Class 1) via the TOTAL module. The totalizer value is depicted in the first four bytes in the form of a floating point number as per the IEEE 754 standard. The fifth byte contains standardized status information pertaining to the totalizer value.

Three Totalizer blocks are available (slot 9 to 11).

*Selection: totalizer value*

Input variable
Mass flow
Volume flow
Corrected volume flow
Target fluid mass flow <sup>1)</sup>
Carrier mass flow <sup>1)</sup>

1) Only available with the "Concentration" application package

*Factory setting*

Function block	Factory setting: TOTAL
Totalizer 1, 2 and 3	Mass flow

*Data structure**Input data of TOTAL*

Byte 1	Byte 2	Byte 3	Byte 4	Byte 5
Measured value: floating point number (IEEE 754)				Status

**SETTOT\_TOTAL module**

The module combination consists of the SETTOT and TOTAL functions:

- SETTOT: Control the totalizers via the PROFIBUS master.
- TOTAL: Transmit totalizer value, along with the status, to the PROFIBUS master.

Three Totalizer blocks are available (slot 9 to 11).

*Selection: control totalizer*

Value SETTOT	Control totalizer
0	Totalize
1	Resetting
2	Adopt totalizer initial setting

*Factory setting*

Function block	Factory setting: Value SETTOT (meaning)
Totalizer 1, 2 and 3	0 (totalizing)

*Data structure*

*Output data of SETTOT*

Byte 1
Control variable 1

*Input data of TOTAL*

Byte 1	Byte 2	Byte 3	Byte 4	Byte 5
Measured value: floating point number (IEEE 754)				Status

**SETTOT\_MODETOT\_TOTAL module**

The module combination consists of the SETTOT, MODETOT and TOTAL functions:

- SETTOT: Control the totalizers via the PROFIBUS master.
- MODETOT: Configure the totalizers via the PROFIBUS master.
- TOTAL: Transmit totalizer value, along with the status, to the PROFIBUS master.

Three Totalizer blocks are available (slot 9 to 11).

*Selection: totalizer configuration*

MODETOT value	Totalizer configuration
0	Balancing
1	Balance the positive flow
2	Balance the negative flow
3	Stop totalizing

*Factory setting*

Function block	Factory setting: Value MODETOT (meaning)
Totalizer 1, 2 and 3	0 (balancing)

*Data structure**Output data of SETTOT and MODETOT*

Byte 1	Byte 2
Control variable 1: SETTOT	Control variable 2: MODETOT

*Input data of TOTAL*

Byte 1	Byte 2	Byte 3	Byte 4	Byte 5
Measured value: floating point number (IEEE 754)				Status

**AO module (Analog Output)**

Transmit a compensation value from the PROFIBUS master (Class 1) to the measuring device.

A compensation value, along with the status, is cyclically transmitted from the PROFIBUS Master (Class 1) to the measuring device via the AO module. The compensation value is depicted in the first four bytes in the form of a floating point number as per the IEEE 754 standard. The fifth byte contains standardized status information pertaining to the compensation value.

Five Analog Output blocks are available (slot 12 to 16).

*Assigned compensation values*

A compensation value is permanently assigned to the individual Analog Output blocks.

Function block	Compensation value
AO 1	External pressure <sup>1)</sup>
AO 2	External temperature <sup>1)</sup>
AO 3	External reference density
AO 4	–
AO 5	–

1) The compensation values must be transmitted to the device in the SI basic unit



The selection is made via: Expert → Sensor → External compensation

*Data structure**Output data of Analog Output*

Byte 1	Byte 2	Byte 3	Byte 4	Byte 5
Measured value: floating point number (IEEE 754)				Status

**DI module (Discrete Input)**

Transmit discrete input values from the measuring device to the PROFIBUS master (Class 1). Discrete input values are used by the measuring device to transmit the state of device functions to the PROFIBUS master (Class 1).

The DI module cyclically transmits the discrete input value, along with the status, to the PROFIBUS Master (Class 1). The discrete input value is depicted in the first byte. The second byte contains standardized status information pertaining to the input value.

Two Discrete Input blocks are available (slot 17 to 18).

*Selection: device function*

Device function	Factory setting: Status (meaning)
Empty pipe detection	<ul style="list-style-type: none"> <li>▪ 0 (device function not active)</li> <li>▪ 1 (device function active)</li> </ul>
Low flow cut off	
Status verification <sup>1)</sup>	<ul style="list-style-type: none"> <li>▪ Bit 0: Verification status - Check not done</li> <li>▪ Bit 1: Verification status - Failed</li> <li>▪ Bit 2: Verification status - Busy</li> <li>▪ Bit 3: Verification status - Ready</li> <li>▪ Bit 4: Verification overall result - Failed</li> <li>▪ Bit 5: Verification overall result - Passed</li> <li>▪ Bit 6: Verification overall result - Check not done</li> <li>▪ Bit 7: Not used</li> </ul>

1) Only available with the Heartbeat Verification application package

*Factory setting*

Function block	Factory setting
DI 1	Empty pipe detection
DI 2	Low flow cut off

*Data structure*

*Input data of Discrete Input*

Byte 1	Byte 2
Discrete	Status

**DO module (Discrete Output)**

Transmit discrete output values from the PROFIBUS master (Class 1) to the measuring device. Discrete output values are used by the PROFIBUS master (Class 1) to enable and disable device functions.

The DO module cyclically transmits the discrete output value, along with the status, to the measuring device. The discrete output value is depicted in the first byte. The second byte contains standardized status information pertaining to the output value.

Seven Discrete Output blocks are available (slot 19 to 25).

*Assigned device functions*

A device function is permanently assigned to the individual Discrete Output blocks.

Function block	Device function	Values: control (meaning)
DO 1	Flow override	<ul style="list-style-type: none"> <li>▪ 0 (disable device function)</li> <li>▪ 1 (enable device function)</li> </ul>
DO 2	Zero point adjustment	
DO 3	Start verification <sup>1)</sup>	
DO 4 (I/O 2)	Relay output or switch output of the pulse/frequency/switch output	<ul style="list-style-type: none"> <li>▪ 0 (non-conductive)</li> <li>▪ 1 (conductive)</li> </ul>
DO 5 (I/O 3)		
DO 6 (I/O 4)		
DO 7	Concentration <sup>2)</sup>	Assignment of medium type (see the following table)

1) Only available with the Heartbeat Verification application package

2) Only available with the Concentration application package

Assignment of medium type: function block DO 7	
101	Fructose in water
102	Glucose in water
104	Hydrogen peroxide in water
105	Sucrose in water
106	Invert sugar in water
107	Nitric acid
108	Phosphoric acid
109	Potassium hydroxide
100	Off
110	Sodium hydroxide
111	Ethanol in water
112	Methanol in water
113	Ammonium nitrate in water
114	Iron(III) chloride in water
115	HFCS42
116	HFCS55
117	HFCS90
118	Original wort
119	% mass / % volume
121	Coef Set No. 1
122	Coef Set No. 2
123	Coef Set No. 3
124	Hydrochloric acid
125	Sulfuric acid

### Data structure

#### Output data of Discrete Output

Byte 1	Byte 2
Discrete	Status

### EMPTY\_MODULE module

This module is used to assign empty spaces arising from modules not being used in the slots .

The measuring device works as a modular PROFIBUS slave. In contrast to a compact slave, a modular PROFIBUS slave has a variable design and consists of several individual modules. The GSD file contains a description of the individual modules along with their individual properties.

The modules are permanently assigned to the slots. When configuring the modules, it is absolutely essential to observe the sequence/arrangement of the modules. Any gaps between the configured modules must be filled with the EMPTY\_MODULE.

## 9.6 Address shifting configuration

### 9.6.1 Function description

The field device also makes acyclic communication services available in addition to cyclic communication. This enables automation systems (PLCs), central engineering stations and asset management systems to exchange data acyclically with the field device. This mode of communication is typically used to configure the field device. Here, addressing at the communication level is implemented by PROFIBUS for slot and index value pairs. The field device makes process and configuration parameters available over a wide range of slot and index values. Currently not all control systems are able to handle communication with such a large address area. Therefore, the field device provides the option of mirroring parameters to slot 0 with the "Address shifting configuration" function. All common masters allow access to slot 0. In the PLC, slot 0 of the field device is generally on the diagnostic address of the relevant field device.

### 9.6.2 Structure

With the "Address shifting configuration" function, 2 address areas are defined in slot 0, the configuration area (index 190 to 221) and the assigned data area (index 230 to 245). The configuration area defines which parameters should be managed.

The configuration area contains the indexes 190 to 221 with which up to 16 parameters can be managed. Two indexes are used per parameter:

- The first index is for the slot value of the parameter
- The second index is for the index value of the parameter

The data area contains the indexes 230 to 245 in slot 0 and is permanently assigned to the configuration area.

Configuration area		Fixed assignment	Data area	
Slot 0, Index	User entry		Slot 0, Index	User entry
190	Slot value for parameter 1	→	230	Value for parameter-specific selection
191	Index value for parameter 1			
192	Slot value for parameter 2	→	231	Value for parameter-specific selection
193	Index value for parameter 2			
194 to 219				
220	Slot value for parameter 16	→	245	Value for parameter-specific selection
221	Index value for parameter 16			

### 9.6.3 Configuring address shifting

When configuring, the specific slot and index values of the parameters must be entered in the configuration area. This area can contain up to 32 entries for 16 parameters. Address shifting configuration supports float- and integer-type parameters with read and write access.

Address shifting can be configured via:

- Local display
- Configuration tool (e.g. FieldCare/DeviceCare)
- PROFIBUS master

Address shifting is configured in the menu Expert → Communication → Address shifting configuration:

*Example*

Configuration area		Fixed assignment	Data area	
Slot 0, Index	Entry = parameter		Slot 0, Index	
190	<b>Slot shifting 1</b> parameter: 48	→	230	1349 = m <sup>3</sup> /h
191	<b>Index shifting 1</b> parameter: 24 = Volume flow unit			
192	<b>Slot shifting 2</b> parameter: 48	→	231	1001 = °C
193	<b>Index shifting 2</b> parameter: 7 = Temperature unit			
194 to 219				
220	<b>Slot shifting 16</b> parameter: 54	→	245	9 = On
221	<b>Index shifting 16</b> parameter: 30 = Empty pipe detection			

The entry values are taken from the device-specific slot/index table. The following excerpt shows the values for the volume flow unit and the temperature unit in the example above.

Description	Slot	Index	Data type	Size [bytes]	Range
Volume flow unit	48	24	Enum16	2	... 1348 : m <sup>3</sup> /min 1349 : m <sup>3</sup> /h 1350 : m <sup>3</sup> /d ...
Temperature unit	48	7	Enum16	2	1001 : °C 1002 : °F 1000 : K 1003 : °R



For more information on the "slot/index table", please contact the Endress+Hauser Sales Center.

### 9.6.4 Accessing data via PROFIBUS DP

The PROFIBUS master uses the indexes 230 to 245 in slot 0 to access the address shifting data area. If, for example, slot 48, index 24 has been entered for the volume flow





parameter via address shifting, the master can read out the current volume flow measured value in slot 0 and index 230.

The data type (integer/float) and data access (read/write) depend on the parameter entered in the configuration area. If the parameter entered supports read and write access, the parameter can also be read- and write-accessed via the data area.

## 10 Commissioning



### 10.1 Function check

Before commissioning the measuring device:



- ▶ Make sure that the post-installation and post-connection checks have been performed.
  - "Post-installation check" checklist →  34
  - "Post-connection check" checklist →  60

### 10.2 Switching on the measuring device

- ▶ After a successful function check, switch on the measuring device.
  - ↳ After a successful startup, the local display switches automatically from the startup display to the operational display.

 If nothing appears on the local display or a diagnostic message is displayed, refer to the section on "Diagnostics and troubleshooting" →  161.

### 10.3 Connecting via FieldCare

- For FieldCare →  82 connection
- For connecting via FieldCare →  85
- For the FieldCare →  86 user interface

### 10.4 Configuring the device address via software

In the "**Communication**" submenu the device address can be set.



#### Navigation

"Setup" menu → Communication → Device address

#### 10.4.1 PROFIBUS network

At time of delivery, the measuring device has the following factory setting:

Device address	126
----------------	-----

- 
  - To display the current device address: **Device address** parameter →  108
  - If hardware addressing is active, software addressing is blocked →  56

### 10.5 Setting the operating language

Factory setting: English or ordered local language

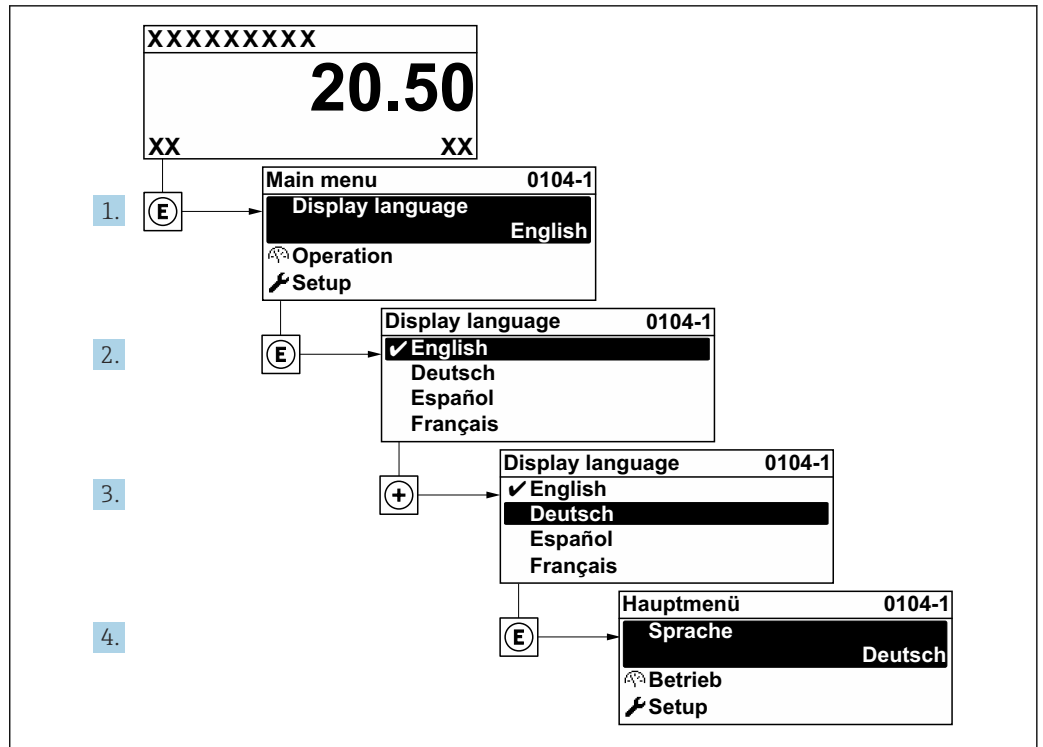

31 Taking the example of the local display

## 10.6 Configuring the measuring device

- The **Setup** menu with its guided wizards contains all the parameters needed for standard operation.
- Navigation to the **Setup** menu

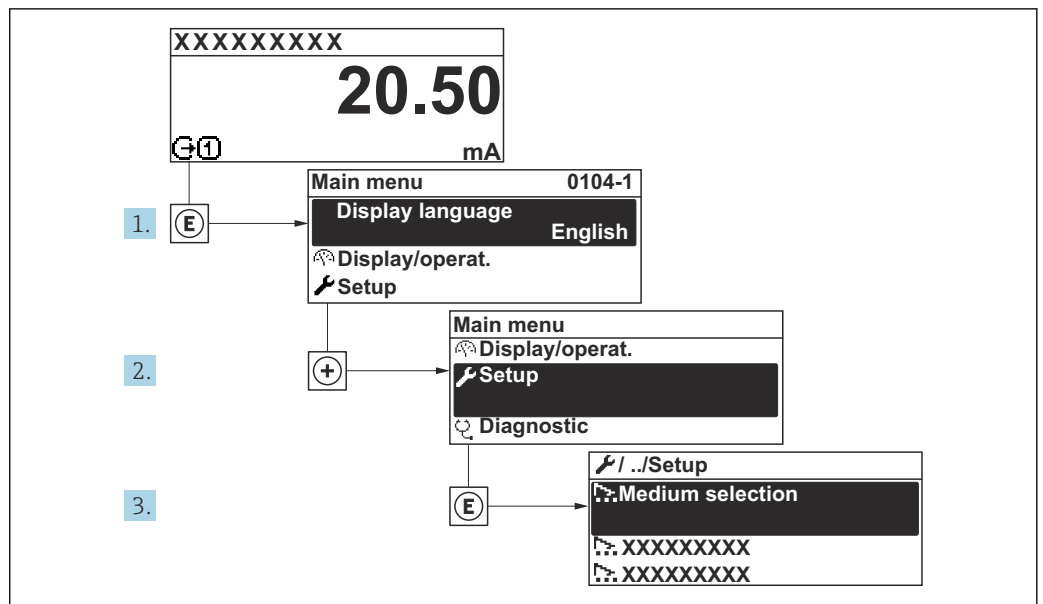

32 Taking the example of the local display

**i** Depending on the device version, not all submenus and parameters are available in every device. The selection can vary depending on the order code.

## Navigation

"Setup" menu

🔧 Setup	
Device tag	→ 📖 105
▶ System units	→ 📖 105
▶ Medium selection	→ 📖 108
▶ Communication	→ 📖 108
▶ Analog inputs	→ 📖 110
▶ I/O configuration	→ 📖 111
▶ Current input 1 to n	→ 📖 112
▶ Status input 1 to n	
▶ Current output 1 to n	→ 📖 114
▶ Pulse/frequency/switch output 1 to n	→ 📖 117
▶ Relay output 1 to n	→ 📖 124
▶ Display	→ 📖 126
▶ Low flow cut off	→ 📖 129
▶ Partially filled pipe detection	→ 📖 130
▶ Advanced setup	→ 📖 131

### 10.6.1 Defining the tag name

To enable fast identification of the measuring point within the system, you can enter a unique designation using the **Device tag** parameter and thus change the factory setting.

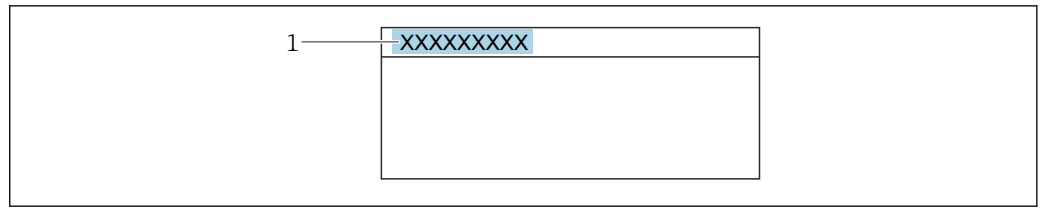

A0029422

33 Header of the operational display with tag name

1 Tag name

Enter the tag name in the "FieldCare" operating tool → 86

**Navigation**

"Setup" menu → Device tag

**Parameter overview with brief description**

Parameter	Description	User entry	Factory setting
Device tag	Enter the name for the measuring point.	Max. 32 characters, such as letters, numbers or special characters (e.g. @, %, /).	Promass 500 DP

**10.6.2 Setting the system units**



In the **System units** submenu the units of all the measured values can be set.

Depending on the device version, not all submenus and parameters are available in every device. The selection can vary depending on the order code.

**Navigation**

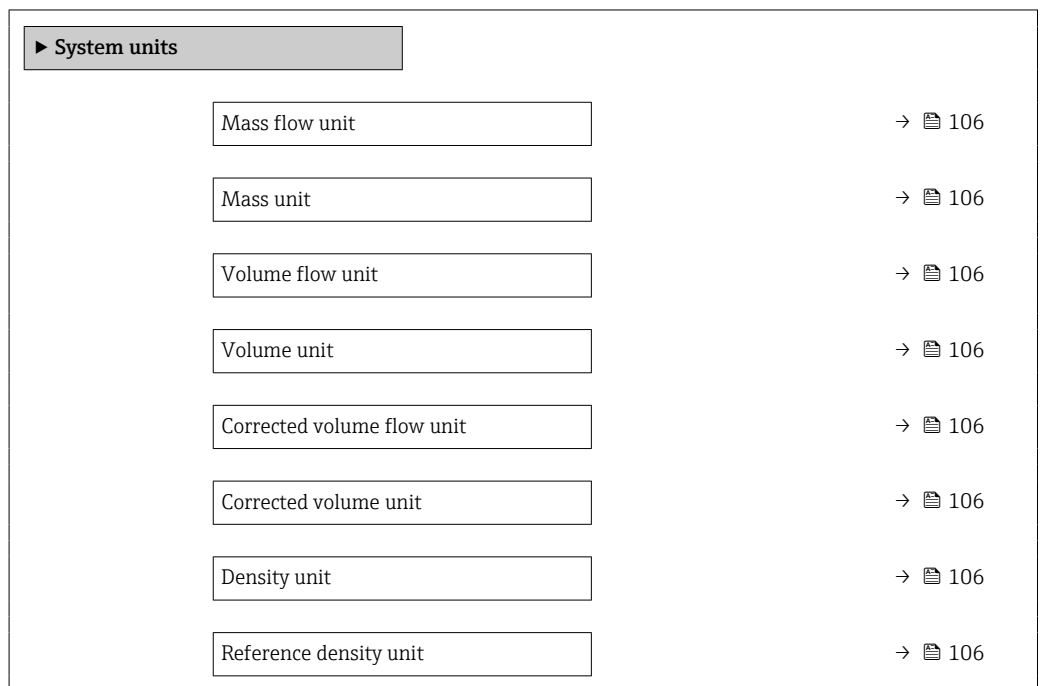
"Setup" menu → System units



Temperature unit	→  107
Pressure unit	→  107

### Parameter overview with brief description

Parameter	Description	Selection	Factory setting
Mass flow unit	Select mass flow unit. <i>Result</i> The selected unit applies for: <ul style="list-style-type: none"> <li>▪ Output</li> <li>▪ Low flow cut off</li> <li>▪ Simulation process variable</li> </ul>	Unit choose list	Country-specific: <ul style="list-style-type: none"> <li>▪ kg/h</li> <li>▪ lb/min</li> </ul>
Mass unit	Select mass unit.	Unit choose list	Country-specific: <ul style="list-style-type: none"> <li>▪ kg</li> <li>▪ lb</li> </ul>
Volume flow unit	Select volume flow unit. <i>Result</i> The selected unit applies for: <ul style="list-style-type: none"> <li>▪ Output</li> <li>▪ Low flow cut off</li> <li>▪ Simulation process variable</li> </ul>	Unit choose list	Country-specific: <ul style="list-style-type: none"> <li>▪ l/h</li> <li>▪ gal/min (us)</li> </ul>
Volume unit	Select volume unit.	Unit choose list	Country-specific: <ul style="list-style-type: none"> <li>▪ l (DN &gt; 150 (6"): m<sup>3</sup> option)</li> <li>▪ gal (us)</li> </ul>
Corrected volume flow unit	Select corrected volume flow unit. <i>Result</i> The selected unit applies for: <b>Corrected volume flow</b> parameter (→  151)	Unit choose list	Country-specific: <ul style="list-style-type: none"> <li>▪ NI/h</li> <li>▪ Sft<sup>3</sup>/min</li> </ul>
Corrected volume unit	Select corrected volume unit.	Unit choose list	Country-specific: <ul style="list-style-type: none"> <li>▪ NI</li> <li>▪ Sft<sup>3</sup></li> </ul>
Density unit	Select density unit. <i>Result</i> The selected unit applies for: <ul style="list-style-type: none"> <li>▪ Output</li> <li>▪ Simulation process variable</li> <li>▪ Density adjustment (<b>Expert</b> menu)</li> </ul>	Unit choose list	Country-specific: <ul style="list-style-type: none"> <li>▪ kg/l</li> <li>▪ lb/ft<sup>3</sup></li> </ul>
Reference density unit	Select reference density unit.	Unit choose list	Country-dependent <ul style="list-style-type: none"> <li>▪ kg/NI</li> <li>▪ lb/Sft<sup>3</sup></li> </ul>

Parameter	Description	Selection	Factory setting
Temperature unit	<p>Select temperature unit.</p> <p><i>Result</i></p> <p>The selected unit applies for:</p> <ul style="list-style-type: none"> <li>▪ <b>Electronic temperature</b> parameter (6053)</li> <li>▪ <b>Maximum value</b> parameter (6051)</li> <li>▪ <b>Minimum value</b> parameter (6052)</li> <li>▪ <b>Maximum value</b> parameter (6108)</li> <li>▪ <b>Minimum value</b> parameter (6109)</li> <li>▪ <b>Carrier pipe temperature</b> parameter (6027)</li> <li>▪ <b>Maximum value</b> parameter (6029)</li> <li>▪ <b>Minimum value</b> parameter (6030)</li> <li>▪ <b>Reference temperature</b> parameter (1816)</li> <li>▪ <b>Temperature</b> parameter</li> </ul>	Unit choose list	<p>Country-specific:</p> <ul style="list-style-type: none"> <li>▪ °C</li> <li>▪ °F</li> </ul>
Pressure unit	<p>Select process pressure unit.</p> <p><i>Result</i></p> <p>The unit is taken from:</p> <ul style="list-style-type: none"> <li>▪ <b>Pressure value</b> parameter (→ ⓘ 108)</li> <li>▪ <b>External pressure</b> parameter (→ ⓘ 108)</li> <li>▪ Pressure value</li> </ul>	Unit choose list	<p>Country-specific:</p> <ul style="list-style-type: none"> <li>▪ bar a</li> <li>▪ psi a</li> </ul>

### 10.6.3 Selecting and setting the medium

The **Select medium** wizard submenu contains parameters that must be configured in order to select and set the medium.

#### Navigation

"Setup" menu → Select medium

► Medium selection	
Select medium	→ ⓘ 108
Pressure compensation	→ ⓘ 108
Pressure value	→ ⓘ 108
External pressure	→ ⓘ 108

#### Parameter overview with brief description

Parameter	Prerequisite	Description	Selection / User entry / User interface
Select medium	–	Select medium type.	Liquid
Pressure compensation	–	Select pressure compensation type.	<ul style="list-style-type: none"> <li>▪ Off</li> <li>▪ Fixed value</li> <li>▪ External value</li> <li>▪ Current input 1 *</li> <li>▪ Current input 2 *</li> <li>▪ Current input 3 *</li> </ul>
Pressure value	The <b>Fixed value</b> option or the <b>Current input 1...n</b> option is selected in the <b>Pressure compensation</b> parameter.	Enter process pressure to be used for pressure correction.	Positive floating-point number
External pressure	The <b>Fixed value</b> option or the <b>Current input 1...n</b> option is selected in the <b>Pressure compensation</b> parameter.	Shows the external process pressure value.	Positive floating-point number

\* Visibility depends on order options or device settings

### 10.6.4 Configuring communication interface

The **Communication** submenu guides you systematically through all the parameters that have to be configured for selecting and setting the communication interface.

#### Navigation

"Setup" menu → Communication

► Communication	
Device address	→ ⓘ 109



**Parameter overview with brief description**

Parameter	Description	User entry
Device address	Enter device address.	0 to 126

### 10.6.5 Configuring the analog inputs

The **Analog inputs** submenu guides the user systematically to the individual **Analog input 1 to n** submenu. From here you get to the parameters of the individual analog input.

#### Navigation

"Setup" menu → Analog inputs

The screenshot shows a hierarchical menu structure for configuring analog inputs. At the top level, there is a button labeled "▶ Analog inputs". Below it, there is a button labeled "▶ Analog input 1 to n". Underneath this, there are four parameter settings, each with a text input field and a right-pointing arrow followed by a document icon and the number "111":

- Channel
- PV filter time
- Fail safe type
- Fail-safe value

## Parameter overview with brief description

Parameter	Prerequisite	Description	Selection / User entry
Channel	–	Select the process variable.	<ul style="list-style-type: none"> <li>■ Mass flow</li> <li>■ Volume flow</li> <li>■ Corrected volume flow</li> <li>■ Density</li> <li>■ Reference density</li> <li>■ Target mass flow *</li> <li>■ Carrier mass flow *</li> <li>■ Concentration *</li> <li>■ Target volume flow</li> <li>■ Carrier volume flow</li> <li>■ Target corrected volume flow</li> <li>■ Carrier corrected volume flow</li> <li>■ Temperature</li> <li>■ Carrier pipe temperature *</li> <li>■ Electronic temperature</li> <li>■ Oscillation frequency 0</li> <li>■ Frequency fluctuation 0</li> <li>■ Oscillation damping 0</li> <li>■ Oscillation damping fluctuation 0</li> <li>■ Oscillation damping fluctuation 1</li> <li>■ Signal asymmetry</li> <li>■ Exciter current 0</li> <li>■ Current input 1 *</li> <li>■ Current input 2 *</li> <li>■ Current input 3 *</li> <li>■ Reference density alternative</li> <li>■ GSV flow</li> <li>■ GSV flow alternative</li> <li>■ NSV flow</li> <li>■ NSV flow alternative</li> <li>■ S&amp;W volume flow</li> <li>■ Oil density</li> <li>■ Water density</li> <li>■ Water cut</li> <li>■ Oil mass flow</li> <li>■ Water mass flow</li> <li>■ Oil volume flow</li> <li>■ Water volume flow</li> <li>■ Oil corrected volume flow</li> <li>■ Water corrected volume flow</li> </ul>
PV filter time	–	Specify the time to suppress signal peaks. During the specified time the analog input does not respond to an erratic increase in the process variable.	Positive floating-point number
Fail safe type	–	Select the failure mode.	<ul style="list-style-type: none"> <li>■ Fail-safe value</li> <li>■ Fallback value</li> <li>■ Off</li> </ul>
Fail-safe value	In <b>Fail safe type</b> parameter, the <b>Fail-safe value</b> option is selected.	Specify the values to be output when an error occurs.	Signed floating-point number

\* Visibility depends on order options or device settings

### 10.6.6 Displaying the I/O configuration

The **I/O configuration** submenu guides the user systematically through all the parameters in which the configuration of the I/O modules is displayed.

**Navigation**

"Setup" menu → I/O configuration

▶ I/O configuration

I/O module 1 to n terminal numbers	→  112
I/O module 1 to n information	→  112
I/O module 1 to n type	→  112
Apply I/O configuration	→  112
Alteration code	→  112

**Parameter overview with brief description**

Parameter	Description	User interface / Selection / User entry
I/O module 1 to n terminal numbers	Shows the terminal numbers used by the I/O module.	<ul style="list-style-type: none"> <li>▪ Not used</li> <li>▪ 26-27 (I/O 1)</li> <li>▪ 24-25 (I/O 2)</li> <li>▪ 22-23 (I/O 3)</li> <li>▪ 20-21 (I/O 4)</li> </ul>
I/O module 1 to n information	Shows information of the plugged I/O module.	<ul style="list-style-type: none"> <li>▪ Not plugged</li> <li>▪ Invalid</li> <li>▪ Not configurable</li> <li>▪ Configurable</li> <li>▪ Profibus DP</li> </ul>
I/O module 1 to n type	Shows the I/O module type.	<ul style="list-style-type: none"> <li>▪ Off</li> <li>▪ Current output<sup>*</sup></li> <li>▪ Current input<sup>*</sup></li> <li>▪ Status input<sup>*</sup></li> <li>▪ Pulse/frequency/switch output<sup>*</sup></li> </ul>
Apply I/O configuration	Apply parameterization of the freely configurable I/O module.	<ul style="list-style-type: none"> <li>▪ No</li> <li>▪ Yes</li> </ul>
Alteration code	Enter the code in order to change the I/O configuration.	Positive integer

\* Visibility depends on order options or device settings

**10.6.7 Configuring the current input**

The "Current input" wizard guides the user systematically through all the parameters that have to be set for configuring the current input.

**Navigation**

"Setup" menu → Current input

▶ Current input 1 to n

Terminal number	→  113
Signal mode	→  113

0/4 mA value	→ ⓘ 113
20 mA value	→ ⓘ 113
Current span	→ ⓘ 113
Failure mode	→ ⓘ 113
Failure value	→ ⓘ 113

### Parameter overview with brief description

Parameter	Prerequisite	Description	User interface / Selection / User entry	Factory setting
Terminal number	–	Shows the terminal numbers used by the current input module.	<ul style="list-style-type: none"> <li>▪ Not used</li> <li>▪ 24-25 (I/O 2)</li> <li>▪ 22-23 (I/O 3)</li> <li>▪ 20-21 (I/O 4)</li> </ul>	–
Signal mode	The measuring device is <b>not</b> approved for use in the hazardous area with type of protection Ex-i.	Select the signal mode for the current input.	<ul style="list-style-type: none"> <li>▪ Passive</li> <li>▪ Active</li> </ul>	Active
0/4 mA value	–	Enter 4 mA value.	Signed floating-point number	–
20 mA value	–	Enter 20 mA value.	Signed floating-point number	Depends on country and nominal diameter
Current span	–	Select current range for process value output and upper/lower level for alarm signal.	<ul style="list-style-type: none"> <li>▪ 4...20 mA</li> <li>▪ 4...20 mA NAMUR</li> <li>▪ 4...20 mA US</li> <li>▪ 0...20 mA</li> </ul>	Country-specific: <ul style="list-style-type: none"> <li>▪ 4...20 mA NAMUR</li> <li>▪ 4...20 mA US</li> </ul>
Failure mode	–	Define input behavior in alarm condition.	<ul style="list-style-type: none"> <li>▪ Alarm</li> <li>▪ Last valid value</li> <li>▪ Defined value</li> </ul>	–
Failure value	In the <b>Failure mode</b> parameter, the <b>Defined value</b> option is selected.	Enter value to be used by the device if input value from external device is missing.	Signed floating-point number	–

### 10.6.8 Configuring the status input

The **Status input** submenu guides the user systematically through all the parameters that have to be set for configuring the status input.

#### Navigation

"Setup" menu → Status input

▶ Status input 1 to n	
Assign status input	→ ⓘ 114
Terminal number	→ ⓘ 114

Active level	→  114
Terminal number	→  114
Response time status input	→  114
Terminal number	→  114

**Parameter overview with brief description**

Parameter	Description	User interface / Selection / User entry
Terminal number	Shows the terminal numbers used by the status input module.	<ul style="list-style-type: none"> <li>▪ Not used</li> <li>▪ 24-25 (I/O 2)</li> <li>▪ 22-23 (I/O 3)</li> <li>▪ 20-21 (I/O 4)</li> </ul>
Assign status input	Select function for the status input.	<ul style="list-style-type: none"> <li>▪ Off</li> <li>▪ Reset totalizer 1</li> <li>▪ Reset totalizer 2</li> <li>▪ Reset totalizer 3</li> <li>▪ Reset all totalizers</li> <li>▪ Flow override</li> </ul>
Active level	Define input signal level at which the assigned function is triggered.	<ul style="list-style-type: none"> <li>▪ High</li> <li>▪ Low</li> </ul>
Response time status input	Define the minimum amount of time the input signal level must be present before the selected function is triggered.	5 to 200 ms



**10.6.9 Configuring the current output**

The **Current output** wizard guides you systematically through all the parameters that have to be set for configuring the current output.

**Navigation**

"Setup" menu → Current output

<b>▶ Current output 1 to n</b>	
Terminal number	→  115
Signal mode	→  115
Assign current output 1 to n	→  115
Current span	→  115
0/4 mA value	→  116
20 mA value	→  116
Fixed current	→  116
Damping output 1 to n	→  116

Failure mode	→  116
Failure current	→  116

**Parameter overview with brief description**

Parameter	Prerequisite	Description	User interface / Selection / User entry	Factory setting
Terminal number	–	Shows the terminal numbers used by the current output module.	<ul style="list-style-type: none"> <li>▪ Not used</li> <li>▪ 24-25 (I/O 2)</li> <li>▪ 22-23 (I/O 3)</li> <li>▪ 20-21 (I/O 4)</li> </ul>	–
Signal mode	–	Select the signal mode for the current output.	<ul style="list-style-type: none"> <li>▪ Passive</li> <li>▪ Active</li> </ul>	Active
Assign current output 1 to n	–	Select process variable for current output.	<ul style="list-style-type: none"> <li>▪ Off</li> <li>▪ Mass flow</li> <li>▪ Volume flow</li> <li>▪ Corrected volume flow</li> <li>▪ Target mass flow *</li> <li>▪ Carrier mass flow *</li> <li>▪ Target volume flow *</li> <li>▪ Carrier volume flow *</li> <li>▪ Target corrected volume flow *</li> <li>▪ Carrier corrected volume flow *</li> <li>▪ Density</li> <li>▪ Reference density</li> <li>▪ Concentration *</li> <li>▪ Temperature</li> <li>▪ Carrier pipe temperature *</li> <li>▪ Electronic temperature</li> <li>▪ Oscillation frequency 0</li> <li>▪ Oscillation amplitude 0 *</li> <li>▪ Frequency fluctuation 0</li> <li>▪ Oscillation damping 0</li> <li>▪ Oscillation damping fluctuation 0</li> <li>▪ Signal asymmetry</li> <li>▪ Exciter current 0</li> <li>▪ HBSI *</li> <li>▪ Pressure *</li> </ul>	–
Current span	–	Select current range for process value output and upper/lower level for alarm signal.	<ul style="list-style-type: none"> <li>▪ 4...20 mA NAMUR</li> <li>▪ 4...20 mA US</li> <li>▪ 4...20 mA</li> <li>▪ 0...20 mA</li> <li>▪ Fixed current</li> </ul>	Country-specific: <ul style="list-style-type: none"> <li>▪ 4...20 mA NAMUR</li> <li>▪ 4...20 mA US</li> </ul>

Parameter	Prerequisite	Description	User interface / Selection / User entry	Factory setting
0/4 mA value	One of the following options is selected in the <b>Current span</b> parameter (→ 115): <ul style="list-style-type: none"> <li>■ 4...20 mA NAMUR</li> <li>■ 4...20 mA US</li> <li>■ 4...20 mA</li> <li>■ 0...20 mA</li> </ul>	Enter 4 mA value.	Signed floating-point number	Country-specific: <ul style="list-style-type: none"> <li>■ 0 kg/h</li> <li>■ 0 lb/min</li> </ul>
20 mA value	One of the following options is selected in the <b>Current span</b> parameter (→ 115): <ul style="list-style-type: none"> <li>■ 4...20 mA NAMUR</li> <li>■ 4...20 mA US</li> <li>■ 4...20 mA</li> <li>■ 0...20 mA</li> </ul>	Enter 20 mA value.	Signed floating-point number	Depends on country and nominal diameter
Fixed current	The <b>Fixed current</b> option is selected in the <b>Current span</b> parameter (→ 115).	Defines the fixed output current.	0 to 22.5 mA	22.5 mA
Damping output 1 to n	A process variable is selected in the <b>Assign current output</b> parameter (→ 115) and one of the following options is selected in the <b>Current span</b> parameter (→ 115): <ul style="list-style-type: none"> <li>■ 4...20 mA NAMUR</li> <li>■ 4...20 mA US</li> <li>■ 4...20 mA</li> <li>■ 0...20 mA</li> </ul>	Set reaction time for output signal to fluctuations in the measured value.	0.0 to 999.9 s	–
Failure mode	A process variable is selected in the <b>Assign current output</b> parameter (→ 115) and one of the following options is selected in the <b>Current span</b> parameter (→ 115): <ul style="list-style-type: none"> <li>■ 4...20 mA NAMUR</li> <li>■ 4...20 mA US</li> <li>■ 4...20 mA</li> <li>■ 0...20 mA</li> </ul>	Define output behavior in alarm condition.	<ul style="list-style-type: none"> <li>■ Min.</li> <li>■ Max.</li> <li>■ Last valid value</li> <li>■ Actual value</li> <li>■ Defined value</li> </ul>	–
Failure current	The <b>Defined value</b> option is selected in the <b>Failure mode</b> parameter.	Enter current output value in alarm condition.	0 to 22.5 mA	22.5 mA

\* Visibility depends on order options or device settings



### 10.6.10 Configuring the pulse/frequency/switch output

The **Pulse/frequency/switch output** wizard guides you systematically through all the parameters that can be set for configuring the selected output type.

#### Navigation

"Setup" menu → Advanced setup → Pulse/frequency/switch output

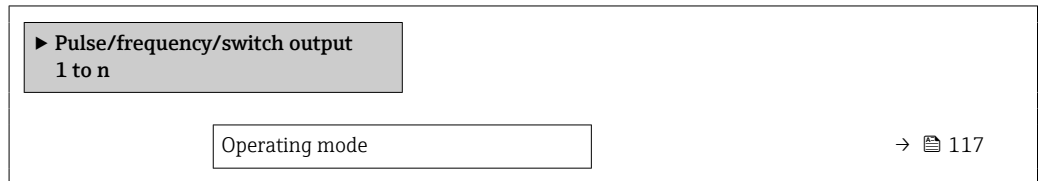

#### Parameter overview with brief description

Parameter	Description	Selection
Operating mode	Define the output as a pulse, frequency or switch output.	<ul style="list-style-type: none"> <li>■ Pulse</li> <li>■ Frequency</li> <li>■ Switch</li> </ul>

#### Configuring the pulse output

#### Navigation

"Setup" menu → Pulse/frequency/switch output

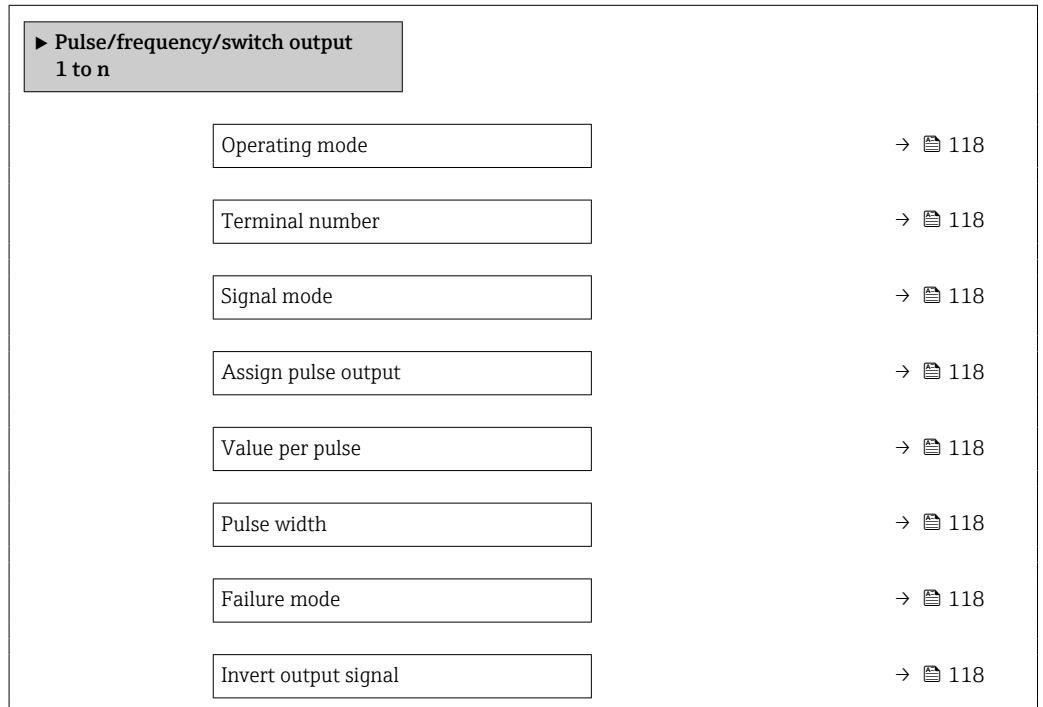

## Parameter overview with brief description

Parameter	Prerequisite	Description	Selection / User interface / User entry	Factory setting
Operating mode	–	Define the output as a pulse, frequency or switch output.	<ul style="list-style-type: none"> <li>▪ Pulse</li> <li>▪ Frequency</li> <li>▪ Switch</li> </ul>	–
Terminal number	–	Shows the terminal numbers used by the PFS output module.	<ul style="list-style-type: none"> <li>▪ Not used</li> <li>▪ 24-25 (I/O 2)</li> <li>▪ 22-23 (I/O 3)</li> <li>▪ 20-21 (I/O 4)</li> </ul>	–
Signal mode	–	Select the signal mode for the PFS output.	<ul style="list-style-type: none"> <li>▪ Passive</li> <li>▪ Active</li> </ul>	–
Assign pulse output 1 to n	The <b>Pulse</b> option is selected in the <b>Operating mode</b> parameter.	Select process variable for pulse output.	<ul style="list-style-type: none"> <li>▪ Off</li> <li>▪ Mass flow</li> <li>▪ Volume flow</li> <li>▪ Corrected volume flow</li> <li>▪ Target mass flow *</li> <li>▪ Carrier mass flow *</li> <li>▪ Target volume flow *</li> <li>▪ Carrier volume flow *</li> <li>▪ Target corrected volume flow *</li> <li>▪ Carrier corrected volume flow *</li> </ul>	–
Value per pulse	The <b>Pulse</b> option is selected in the <b>Operating mode</b> parameter (→ 117) and a process variable is selected in the <b>Assign pulse output</b> parameter (→ 118).	Enter measured value at which a pulse is output.	Signed floating-point number	Depends on country and nominal diameter
Pulse width	The <b>Pulse</b> option is selected in the <b>Operating mode</b> parameter (→ 117) and a process variable is selected in the <b>Assign pulse output</b> parameter (→ 118).	Define time width of the output pulse.	0.05 to 2 000 ms	–
Failure mode	The <b>Pulse</b> option is selected in the <b>Operating mode</b> parameter (→ 117) and a process variable is selected in the <b>Assign pulse output</b> parameter (→ 118).	Define output behavior in alarm condition.	<ul style="list-style-type: none"> <li>▪ Actual value</li> <li>▪ No pulses</li> </ul>	–
Invert output signal	–	Invert the output signal.	<ul style="list-style-type: none"> <li>▪ No</li> <li>▪ Yes</li> </ul>	–

\* Visibility depends on order options or device settings

### Configuring the frequency output

#### Navigation







"Setup" menu → Pulse/frequency/switch output

► Pulse/frequency/switch output 1 to n	
Operating mode	→ 119
Terminal number	→ 119
Signal mode	→ 119
Assign frequency output	→ 120
Minimum frequency value	→ 120
Maximum frequency value	→ 120
Measuring value at minimum frequency	→ 120
Measuring value at maximum frequency	→ 121
Failure mode	→ 121
Failure frequency	→ 121
Invert output signal	→ 121

#### Parameter overview with brief description

Parameter	Prerequisite	Description	Selection / User interface / User entry	Factory setting
Operating mode	–	Define the output as a pulse, frequency or switch output.	<ul style="list-style-type: none"> <li>■ Pulse</li> <li>■ Frequency</li> <li>■ Switch</li> </ul>	–
Terminal number	–	Shows the terminal numbers used by the PFS output module.	<ul style="list-style-type: none"> <li>■ Not used</li> <li>■ 24-25 (I/O 2)</li> <li>■ 22-23 (I/O 3)</li> <li>■ 20-21 (I/O 4)</li> </ul>	–
Signal mode	–	Select the signal mode for the PFS output.	<ul style="list-style-type: none"> <li>■ Passive</li> <li>■ Active</li> </ul>	–

Parameter	Prerequisite	Description	Selection / User interface / User entry	Factory setting
Assign frequency output	The <b>Frequency</b> option is selected in the <b>Operating mode</b> parameter (→ 117) parameter.	Select process variable for frequency output.	<ul style="list-style-type: none"> <li>▪ Off</li> <li>▪ Mass flow</li> <li>▪ Volume flow</li> <li>▪ Corrected volume flow</li> <li>▪ Target mass flow *</li> <li>▪ Carrier mass flow *</li> <li>▪ Target volume flow *</li> <li>▪ Carrier volume flow *</li> <li>▪ Target corrected volume flow *</li> <li>▪ Carrier corrected volume flow *</li> <li>▪ Density</li> <li>▪ Reference density *</li> <li>▪ Concentration *</li> <li>▪ Temperature</li> <li>▪ Carrier pipe temperature *</li> <li>▪ Electronic temperature</li> <li>▪ Oscillation frequency 0</li> <li>▪ Oscillation amplitude 0</li> <li>▪ Frequency fluctuation 0</li> <li>▪ Oscillation damping 0</li> <li>▪ Oscillation damping fluctuation 0</li> <li>▪ Signal asymmetry</li> <li>▪ Exciter current 0</li> <li>▪ HBSI *</li> <li>▪ Pressure</li> </ul>	–
Minimum frequency value	The <b>Frequency</b> option is selected in the <b>Operating mode</b> parameter (→ 117) and a process variable is selected in the <b>Assign frequency output</b> parameter (→ 120).	Enter minimum frequency.	0.0 to 10 000.0 Hz	–
Maximum frequency value	The <b>Frequency</b> option is selected in the <b>Operating mode</b> parameter (→ 117) and a process variable is selected in the <b>Assign frequency output</b> parameter (→ 120).	Enter maximum frequency.	0.0 to 10 000.0 Hz	–
Measuring value at minimum frequency	The <b>Frequency</b> option is selected in the <b>Operating mode</b> parameter (→ 117) and a process variable is selected in the <b>Assign frequency output</b> parameter (→ 120).	Enter measured value for minimum frequency.	Signed floating-point number	Depends on country and nominal diameter

Parameter	Prerequisite	Description	Selection / User interface / User entry	Factory setting
Measuring value at maximum frequency	The <b>Frequency</b> option is selected in the <b>Operating mode</b> parameter (→  117) and a process variable is selected in the <b>Assign frequency output</b> parameter (→  120).	Enter measured value for maximum frequency.	Signed floating-point number	Depends on country and nominal diameter
Failure mode	The <b>Frequency</b> option is selected in the <b>Operating mode</b> parameter (→  117) and a process variable is selected in the <b>Assign frequency output</b> parameter (→  120).	Define output behavior in alarm condition.	<ul style="list-style-type: none"> <li>▪ Actual value</li> <li>▪ Defined value</li> <li>▪ 0 Hz</li> </ul>	–
Failure frequency	The <b>Frequency</b> option is selected in the <b>Operating mode</b> parameter (→  117) and a process variable is selected in the <b>Assign frequency output</b> parameter (→  120).	Enter frequency output value in alarm condition.	0.0 to 12 500.0 Hz	–
Invert output signal	–	Invert the output signal.	<ul style="list-style-type: none"> <li>▪ No</li> <li>▪ Yes</li> </ul>	–

\* Visibility depends on order options or device settings

## Configuring the switch output

### Navigation

"Setup" menu → Pulse/frequency/switch output

► Pulse/frequency/switch output 1 to n	
Operating mode	→ 122
Terminal number	→ 122
Signal mode	→ 122
Switch output function	→ 123
Assign diagnostic behavior	→ 123
Assign limit	→ 123
Assign flow direction check	→ 123
Assign status	→ 123
Switch-on value	→ 123
Switch-off value	→ 124
Switch-on delay	→ 124
Switch-off delay	→ 124
Failure mode	→ 124
Invert output signal	→ 124

### Parameter overview with brief description

Parameter	Prerequisite	Description	Selection / User interface / User entry	Factory setting
Operating mode	–	Define the output as a pulse, frequency or switch output.	<ul style="list-style-type: none"> <li>▪ Pulse</li> <li>▪ Frequency</li> <li>▪ Switch</li> </ul>	–
Terminal number	–	Shows the terminal numbers used by the PFS output module.	<ul style="list-style-type: none"> <li>▪ Not used</li> <li>▪ 24-25 (I/O 2)</li> <li>▪ 22-23 (I/O 3)</li> <li>▪ 20-21 (I/O 4)</li> </ul>	–
Signal mode	–	Select the signal mode for the PFS output.	<ul style="list-style-type: none"> <li>▪ Passive</li> <li>▪ Active</li> </ul>	–

Parameter	Prerequisite	Description	Selection / User interface / User entry	Factory setting
Switch output function	The <b>Switch</b> option is selected in the <b>Operating mode</b> parameter.	Select function for switch output.	<ul style="list-style-type: none"> <li>■ Off</li> <li>■ On</li> <li>■ Diagnostic behavior</li> <li>■ Limit</li> <li>■ Flow direction check</li> <li>■ Status</li> </ul>	–
Assign diagnostic behavior	<ul style="list-style-type: none"> <li>■ In the <b>Operating mode</b> parameter, the <b>Switch</b> option is selected.</li> <li>■ In the <b>Switch output function</b> parameter, the <b>Diagnostic behavior</b> option is selected.</li> </ul>	Select diagnostic behavior for switch output.	<ul style="list-style-type: none"> <li>■ Alarm</li> <li>■ Alarm or warning</li> <li>■ Warning</li> </ul>	–
Assign limit	<ul style="list-style-type: none"> <li>■ The <b>Switch</b> option is selected in the <b>Operating mode</b> parameter.</li> <li>■ The <b>Limit</b> option is selected in the <b>Switch output function</b> parameter.</li> </ul>	Select process variable for limit function.	<ul style="list-style-type: none"> <li>■ Mass flow</li> <li>■ Volume flow</li> <li>■ Corrected volume flow</li> <li>■ Target mass flow *</li> <li>■ Carrier mass flow *</li> <li>■ Target volume flow *</li> <li>■ Carrier volume flow *</li> <li>■ Target corrected volume flow *</li> <li>■ Carrier corrected volume flow *</li> <li>■ Density</li> <li>■ Reference density</li> <li>■ Concentration *</li> <li>■ Temperature</li> <li>■ Oscillation damping</li> <li>■ Pressure</li> <li>■ Totalizer 1</li> <li>■ Totalizer 2</li> <li>■ Totalizer 3</li> </ul>	–
Assign flow direction check	<ul style="list-style-type: none"> <li>■ The <b>Switch</b> option is selected in the <b>Operating mode</b> parameter.</li> <li>■ The <b>Flow direction check</b> option is selected in the <b>Switch output function</b> parameter.</li> </ul>	Select process variable for flow direction monitoring.	<ul style="list-style-type: none"> <li>■ Off</li> <li>■ Volume flow</li> <li>■ Mass flow</li> <li>■ Corrected volume flow</li> </ul>	–
Assign status	<ul style="list-style-type: none"> <li>■ The <b>Switch</b> option is selected in the <b>Operating mode</b> parameter.</li> <li>■ The <b>Status</b> option is selected in the <b>Switch output function</b> parameter.</li> </ul>	Select device status for switch output.	<ul style="list-style-type: none"> <li>■ Partially filled pipe detection</li> <li>■ Low flow cut off</li> <li>■ Digital output 4</li> <li>■ Digital output 5</li> <li>■ Digital output 6</li> </ul>	–
Switch-on value	<ul style="list-style-type: none"> <li>■ In the <b>Operating mode</b> parameter, the <b>Switch</b> option is selected.</li> <li>■ In the <b>Switch output function</b> parameter, the <b>Limit</b> option is selected.</li> </ul>	Enter measured value for the switch-on point.	Signed floating-point number	Country-specific: <ul style="list-style-type: none"> <li>■ 0 kg/h</li> <li>■ 0 lb/min</li> </ul>

Parameter	Prerequisite	Description	Selection / User interface / User entry	Factory setting
Switch-off value	<ul style="list-style-type: none"> <li>In the <b>Operating mode</b> parameter, the <b>Switch</b> option is selected.</li> <li>In the <b>Switch output function</b> parameter, the <b>Limit</b> option is selected.</li> </ul>	Enter measured value for the switch-off point.	Signed floating-point number	Country-specific: <ul style="list-style-type: none"> <li>0 kg/h</li> <li>0 lb/min</li> </ul>
Switch-on delay	<ul style="list-style-type: none"> <li>The <b>Switch</b> option is selected in the <b>Operating mode</b> parameter.</li> <li>The <b>Limit</b> option is selected in the <b>Switch output function</b> parameter.</li> </ul>	Define delay for the switch-on of status output.	0.0 to 100.0 s	–
Switch-off delay	<ul style="list-style-type: none"> <li>The <b>Switch</b> option is selected in the <b>Operating mode</b> parameter.</li> <li>The <b>Limit</b> option is selected in the <b>Switch output function</b> parameter.</li> </ul>	Define delay for the switch-off of status output.	0.0 to 100.0 s	–
Failure mode	–	Define output behavior in alarm condition.	<ul style="list-style-type: none"> <li>Actual status</li> <li>Open</li> <li>Closed</li> </ul>	–
Invert output signal	–	Invert the output signal.	<ul style="list-style-type: none"> <li>No</li> <li>Yes</li> </ul>	–

\* Visibility depends on order options or device settings

### 10.6.11 Configuring the relay output

The **Relay output** wizard guides the user systematically through all the parameters that have to be set for configuring the relay output.

#### Navigation

"Setup" menu → Relay output 1 to n

► RelaisOutput 1 to n	
Switch output function	→ 125
Assign flow direction check	→ 125
Assign limit	→ 125
Assign diagnostic behavior	→ 125
Assign status	→ 125
Switch-off value	→ 125
Switch-on value	→ 125
Failure mode	→ 126



## Parameter overview with brief description

Parameter	Prerequisite	Description	Selection / User interface / User entry	Factory setting
Relay output function	–	Select the function for the relay output.	<ul style="list-style-type: none"> <li>■ Closed</li> <li>■ Open</li> <li>■ Diagnostic behavior</li> <li>■ Limit</li> <li>■ Flow direction check</li> <li>■ Digital Output</li> </ul>	–
Terminal number	–	Shows the terminal numbers used by the relay output module.	<ul style="list-style-type: none"> <li>■ Not used</li> <li>■ 24-25 (I/O 2)</li> <li>■ 22-23 (I/O 3)</li> <li>■ 20-21 (I/O 4)</li> </ul>	–
Assign flow direction check	In the <b>Relay output function</b> parameter, the <b>Flow direction check</b> option is selected.	Select process variable for flow direction monitoring.	<ul style="list-style-type: none"> <li>■ Off</li> <li>■ Volume flow</li> <li>■ Mass flow</li> <li>■ Corrected volume flow</li> </ul>	–
Assign limit	The <b>Limit</b> option is selected in the <b>Relay output function</b> parameter.	Select process variable for limit function.	<ul style="list-style-type: none"> <li>■ Mass flow</li> <li>■ Volume flow</li> <li>■ Corrected volume flow</li> <li>■ Target mass flow *</li> <li>■ Carrier mass flow *</li> <li>■ Target volume flow *</li> <li>■ Carrier volume flow *</li> <li>■ Target corrected volume flow *</li> <li>■ Carrier corrected volume flow *</li> <li>■ Density</li> <li>■ Reference density</li> <li>■ Concentration *</li> <li>■ Temperature</li> <li>■ Oscillation damping</li> <li>■ Pressure</li> <li>■ Totalizer 1</li> <li>■ Totalizer 2</li> <li>■ Totalizer 3</li> </ul>	–
Assign diagnostic behavior	In the <b>Relay output function</b> parameter, the <b>Diagnostic behavior</b> option is selected.	Select diagnostic behavior for switch output.	<ul style="list-style-type: none"> <li>■ Alarm</li> <li>■ Alarm or warning</li> <li>■ Warning</li> </ul>	–
Assign status	In the <b>Relay output function</b> parameter, the <b>Digital Output</b> option is selected.	Select device status for switch output.	<ul style="list-style-type: none"> <li>■ Partially filled pipe detection</li> <li>■ Low flow cut off</li> <li>■ Digital output 4</li> <li>■ Digital output 5</li> <li>■ Digital output 6</li> </ul>	–
Switch-off value	In the <b>Relay output function</b> parameter, the <b>Limit</b> option is selected.	Enter measured value for the switch-off point.	Signed floating-point number	Country-specific: <ul style="list-style-type: none"> <li>■ 0 kg/h</li> <li>■ 0 lb/min</li> </ul>
Switch-off delay	In the <b>Relay output function</b> parameter, the <b>Limit</b> option is selected.	Define delay for the switch-off of status output.	0.0 to 100.0 s	–
Switch-on value	In the <b>Relay output function</b> parameter, the <b>Limit</b> option is selected.	Enter measured value for the switch-on point.	Signed floating-point number	Country-specific: <ul style="list-style-type: none"> <li>■ 0 kg/h</li> <li>■ 0 lb/min</li> </ul>

Parameter	Prerequisite	Description	Selection / User interface / User entry	Factory setting
Switch-on delay	In the <b>Relay output function</b> parameter, the <b>Limit</b> option is selected.	Define delay for the switch-on of status output.	0.0 to 100.0 s	–
Failure mode	–	Define output behavior in alarm condition.	<ul style="list-style-type: none"> <li>▪ Actual status</li> <li>▪ Open</li> <li>▪ Closed</li> </ul>	–

\* Visibility depends on order options or device settings

### 10.6.12 Configuring the local display

The **Display** wizard guides you systematically through all the parameters that can be configured for configuring the local display.



#### Navigation

"Setup" menu → Display

► Display	
Format display	→ 127
Value 1 display	→ 127
0% bargraph value 1	→ 127
100% bargraph value 1	→ 127
Value 2 display	→ 127
Value 3 display	→ 128
0% bargraph value 3	→ 128
100% bargraph value 3	→ 128
Value 4 display	→ 128

## Parameter overview with brief description

Parameter	Prerequisite	Description	Selection / User entry	Factory setting
Format display	A local display is provided.	Select how measured values are shown on the display.	<ul style="list-style-type: none"> <li>■ 1 value, max. size</li> <li>■ 1 bargraph + 1 value</li> <li>■ 2 values</li> <li>■ 1 value large + 2 values</li> <li>■ 4 values</li> </ul>	–
Value 1 display	A local display is provided.	Select the measured value that is shown on the local display.	<ul style="list-style-type: none"> <li>■ Mass flow</li> <li>■ Volume flow</li> <li>■ Corrected volume flow</li> <li>■ Target mass flow *</li> <li>■ Carrier mass flow *</li> <li>■ Target volume flow *</li> <li>■ Carrier volume flow *</li> <li>■ Target corrected volume flow *</li> <li>■ Carrier corrected volume flow *</li> <li>■ Density</li> <li>■ Reference density *</li> <li>■ Concentration *</li> <li>■ Temperature</li> <li>■ Carrier pipe temperature *</li> <li>■ Electronic temperature</li> <li>■ Oscillation frequency 0</li> <li>■ Oscillation amplitude 0 *</li> <li>■ Frequency fluctuation 0</li> <li>■ Oscillation damping 0</li> <li>■ Oscillation damping fluctuation 0</li> <li>■ Signal asymmetry</li> <li>■ Exciter current 0</li> <li>■ Totalizer 1</li> <li>■ Totalizer 2</li> <li>■ Totalizer 3</li> <li>■ Current output 1</li> <li>■ Current output 2 *</li> <li>■ Current output 3 *</li> <li>■ Current output 4 *</li> <li>■ Pressure</li> </ul>	–
0% bargraph value 1	A local display is provided.	Enter 0% value for bar graph display.	Signed floating-point number	Country-specific: <ul style="list-style-type: none"> <li>■ 0 kg/h</li> <li>■ 0 lb/min</li> </ul>
100% bargraph value 1	A local display is provided.	Enter 100% value for bar graph display.	Signed floating-point number	Depends on country and nominal diameter
Value 2 display	A local display is provided.	Select the measured value that is shown on the local display.	For the picklist, see the <b>Value 1 display</b> parameter (→  127)	–

Parameter	Prerequisite	Description	Selection / User entry	Factory setting
Value 3 display	A local display is provided.	Select the measured value that is shown on the local display.	For the picklist, see the <b>Value 1 display</b> parameter (→  127)	–
0% bargraph value 3	A selection was made in the <b>Value 3 display</b> parameter.	Enter 0% value for bar graph display.	Signed floating-point number	Country-specific: <ul style="list-style-type: none"> <li>■ 0 kg/h</li> <li>■ 0 lb/min</li> </ul>
100% bargraph value 3	A selection was made in the <b>Value 3 display</b> parameter.	Enter 100% value for bar graph display.	Signed floating-point number	–
Value 4 display	A local display is provided.	Select the measured value that is shown on the local display.	For the picklist, see the <b>Value 1 display</b> parameter (→  127)	–

\* Visibility depends on order options or device settings

### 10.6.13 Configuring the low flow cut off

The **Low flow cut off** wizard systematically guides the user through all the parameters that must be set to configure low flow cut off.

#### Navigation

"Setup" menu → Low flow cut off

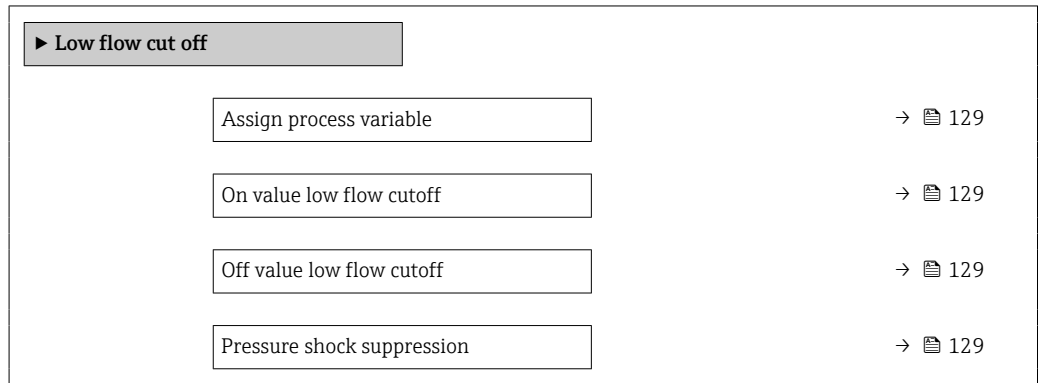

#### Parameter overview with brief description





Parameter	Prerequisite	Description	Selection / User entry	Factory setting
Assign process variable	–	Select process variable for low flow cut off.	<ul style="list-style-type: none"> <li>■ Off</li> <li>■ Mass flow</li> <li>■ Volume flow</li> <li>■ Corrected volume flow</li> </ul>	–
On value low flow cutoff	A process variable is selected in the <b>Assign process variable</b> parameter (→ 129).	Enter on value for low flow cut off.	Positive floating-point number	Depends on country and nominal diameter
Off value low flow cutoff	A process variable is selected in the <b>Assign process variable</b> parameter (→ 129).	Enter off value for low flow cut off.	0 to 100.0 %	–
Pressure shock suppression	A process variable is selected in the <b>Assign process variable</b> parameter (→ 129).	Enter time frame for signal suppression (= active pressure shock suppression).	0 to 100 s	–

### 10.6.14 Configuring the partial filled pipe detection



The **Partial filled pipe detection** wizard guides you systematically through all parameters that have to be set for configuring the monitoring of the pipe filling.

#### Navigation

"Setup" menu → Partially filled pipe detection

▶ Partially filled pipe detection	
Assign process variable	→  130
Low value partial filled pipe detection	→  130
High value partial filled pipe detection	→  130
Response time part. filled pipe detect.	→  130

#### Parameter overview with brief description

Parameter	Prerequisite	Description	Selection / User entry
Assign process variable	–	Select process variable for partially filled pipe detection.	<ul style="list-style-type: none"> <li>▪ Off</li> <li>▪ Density</li> <li>▪ Reference density</li> </ul>
Low value partial filled pipe detection	A process variable is selected in the <b>Assign process variable</b> parameter (→  130).	Enter lower limit value for deactivating partially filled pipe detection.	Signed floating-point number
High value partial filled pipe detection	A process variable is selected in the <b>Assign process variable</b> parameter (→  130).	Enter upper limit value for deactivating partially filled pipe detection.	Signed floating-point number
Response time part. filled pipe detect.	A process variable is selected in the <b>Assign process variable</b> parameter (→  130).	Enter time before diagnostic message is displayed for partially filled pipe detection.	0 to 100 s

## 10.7 Advanced settings

The **Advanced setup** submenu together with its submenus contains parameters for specific settings.

*Navigation to the "Advanced setup" submenu*

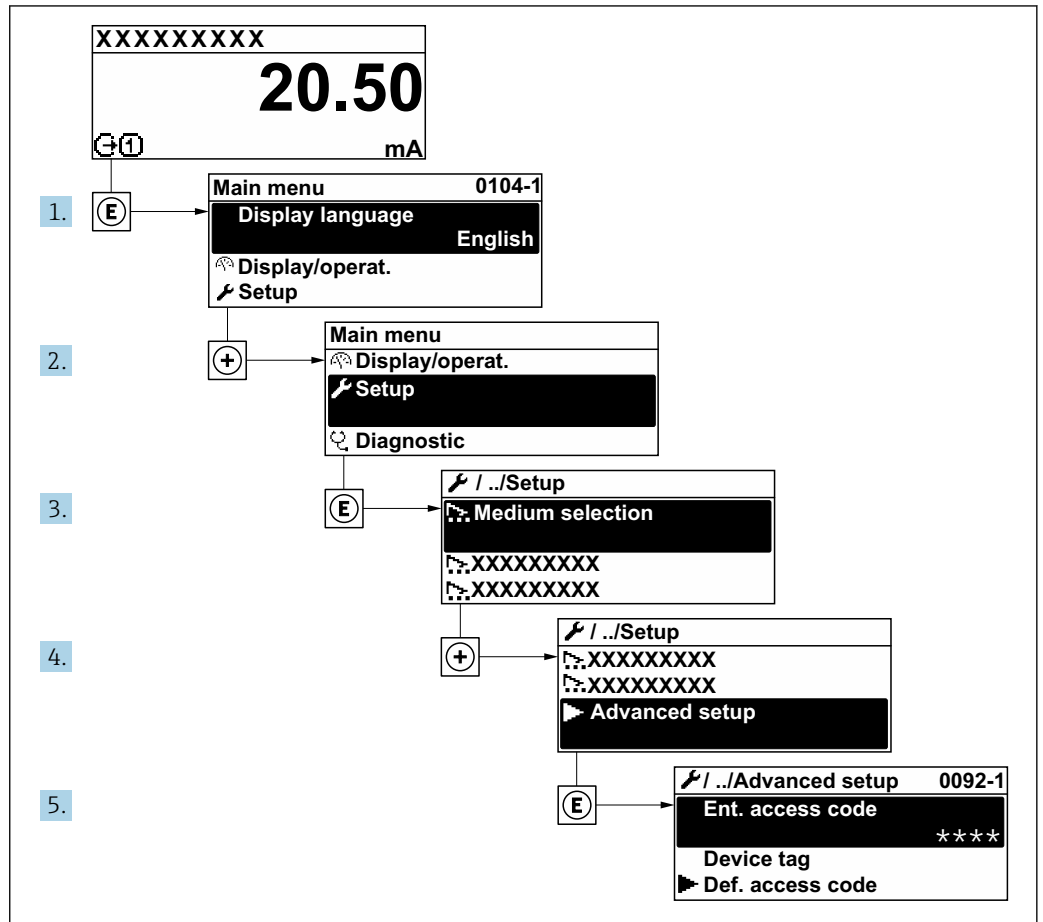

A003223-EN

**i** The number of submenus can vary depending on the device version. Some submenus are not dealt with in the Operating Instructions. These submenus and the parameters they contain are explained in the Special Documentation for the device.

### Navigation

"Setup" menu → Advanced setup

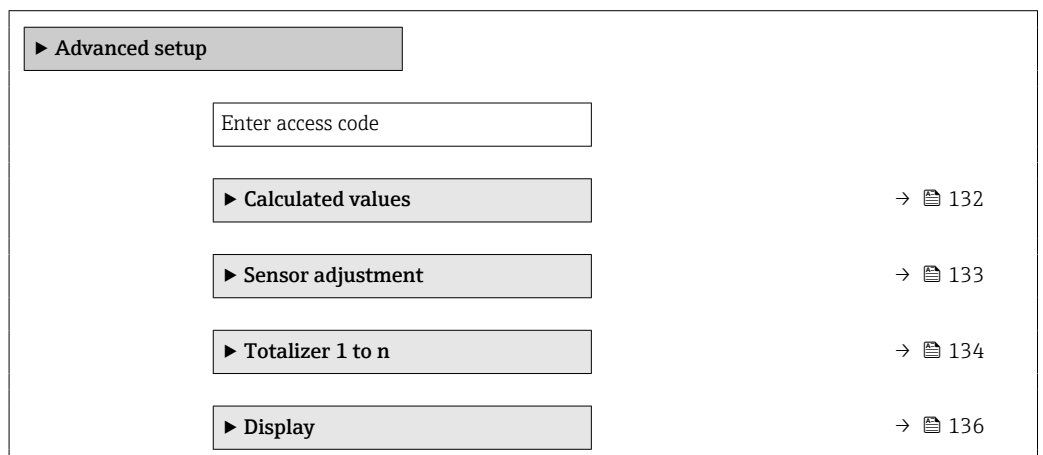

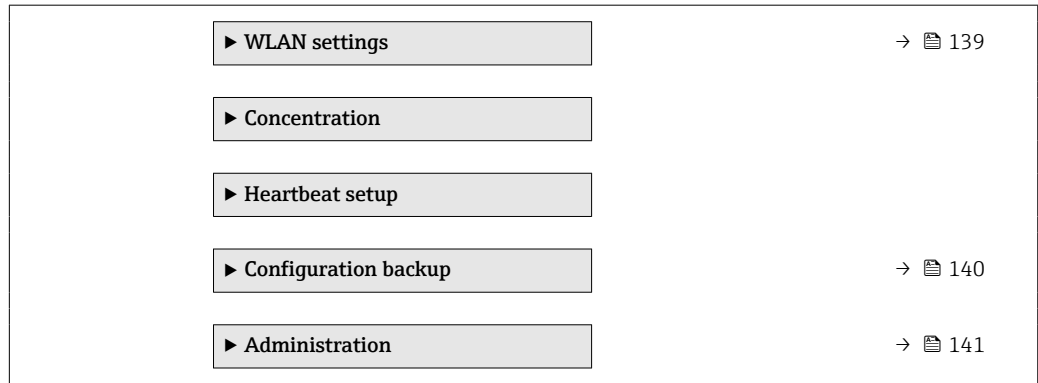

### 10.7.1 Calculated values

The **Calculated values** submenu contains parameters for calculating the corrected volume flow.

#### Navigation

"Setup" menu → Advanced setup → Calculated values

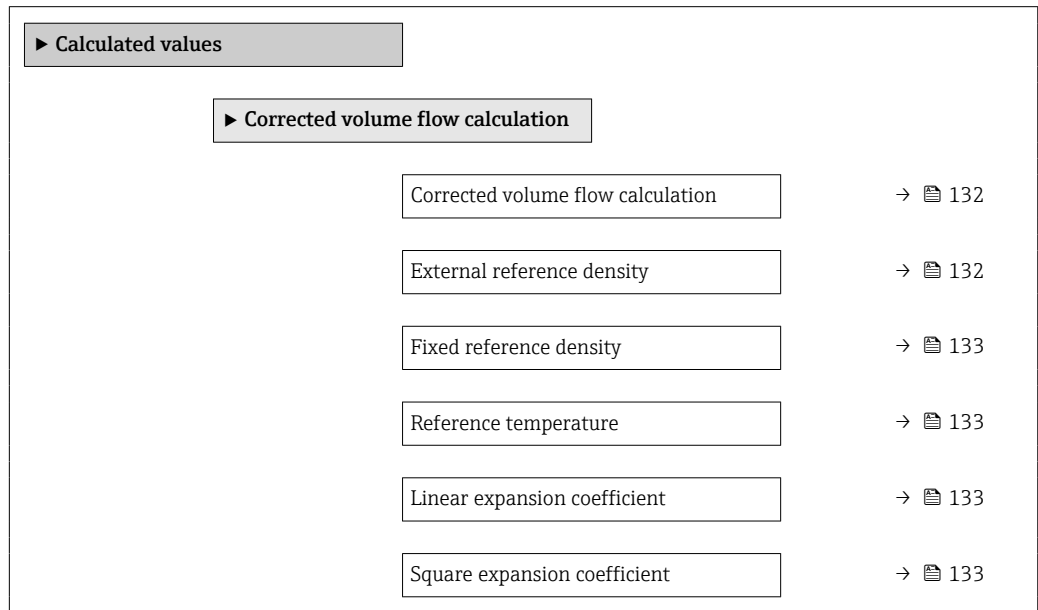

#### Parameter overview with brief description

Parameter	Prerequisite	Description	Selection / User interface / User entry	Factory setting
Corrected volume flow calculation	-	Select reference density for calculating the corrected volume flow.	<ul style="list-style-type: none"> <li>■ Fixed reference density</li> <li>■ Calculated reference density</li> <li>■ External reference density</li> <li>■ Current input 1 *</li> <li>■ Current input 2 *</li> <li>■ Current input 3 *</li> </ul>	-
External reference density	In the <b>Corrected volume flow calculation</b> parameter, the <b>External reference density</b> option is selected.	Shows external reference density.	Floating point number with sign	-



Parameter	Prerequisite	Description	Selection / User interface / User entry	Factory setting
Fixed reference density	The <b>Fixed reference density</b> option is selected in the <b>Corrected volume flow calculation</b> parameter parameter.	Enter fixed value for reference density.	Positive floating-point number	-
Reference temperature	The <b>Calculated reference density</b> option is selected in the <b>Corrected volume flow calculation</b> parameter parameter.	Enter reference temperature for calculating the reference density.	-273.15 to 99999 °C	Country-specific: <ul style="list-style-type: none"> <li>■ +20 °C</li> <li>■ +68 °F</li> </ul>
Linear expansion coefficient	The <b>Calculated reference density</b> option is selected in the <b>Corrected volume flow calculation</b> parameter parameter.	Enter linear, medium-specific expansion coefficient for calculating the reference density.	Signed floating-point number	-
Square expansion coefficient	The <b>Calculated reference density</b> option is selected in the <b>Corrected volume flow calculation</b> parameter parameter.	For media with a non-linear expansion pattern: enter the quadratic, medium-specific expansion coefficient for calculating the reference density.	Signed floating-point number	-

\* Visibility depends on order options or device settings

### 10.7.2 Carrying out a sensor adjustment

The **Sensor adjustment** submenu contains parameters that pertain to the functionality of the sensor.

#### Navigation

"Setup" menu → Advanced setup → Sensor adjustment

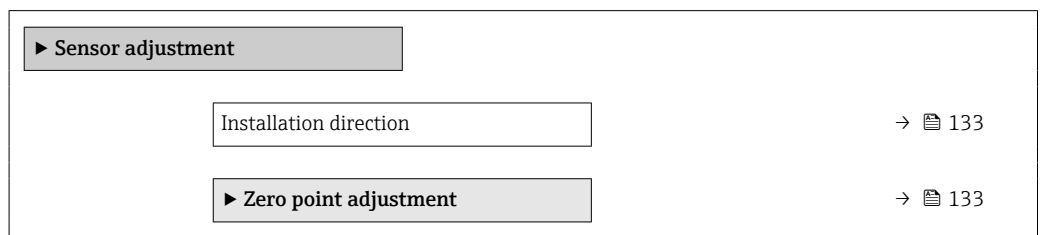

#### Parameter overview with brief description

Parameter	Description	Selection
Installation direction	Set sign of flow direction to match the direction of the arrow on the sensor.	<ul style="list-style-type: none"> <li>■ Flow in arrow direction</li> <li>■ Flow against arrow direction</li> </ul>

#### Zero point adjustment

All measuring devices are calibrated in accordance with state-of-the-art technology. Calibration takes place under reference conditions → 248. Therefore, a zero point adjustment in the field is generally not required.

Experience shows that zero point adjustment is advisable only in special cases:

- To achieve maximum measuring accuracy even with low flow rates.
- Under extreme process or operating conditions (e.g. very high process temperatures or very high-viscosity fluids).

**Navigation**

"Setup" menu → Advanced setup → Sensor adjustment → Zero point adjustment

▶ Zero point adjustment	
Zero point adjustment control	→ 134
Progress	→ 134

**Parameter overview with brief description**

Parameter	Description	Selection / User interface	Factory setting
Zero point adjustment control	Start zero point adjustment.	<ul style="list-style-type: none"> <li>■ Cancel</li> <li>■ Busy</li> <li>■ Zero point adjust failure</li> <li>■ Start</li> </ul>	–
Progress	Shows the progress of the process.	0 to 100 %	–

**10.7.3 Configuring the totalizer**

In the "Totalizer 1 to n" submenu the individual totalizer can be configured.

**Navigation**

"Setup" menu → Advanced setup → Totalizer 1 to n

▶ Totalizer 1 to n	
Assign process variable	→ 135
Unit totalizer	→ 135
Totalizer operation mode	→ 135
Control Totalizer 1 to n	
Failure mode	→ 135

## Parameter overview with brief description















Parameter	Description	Selection	Factory setting
Assign process variable	Select process variable for totalizer.	<ul style="list-style-type: none"> <li>■ Mass flow</li> <li>■ Volume flow</li> <li>■ Corrected volume flow</li> <li>■ Target mass flow</li> <li>■ Carrier mass flow</li> <li>■ Target volume flow</li> <li>■ Carrier volume flow</li> <li>■ Target corrected volume flow</li> <li>■ Carrier corrected volume flow</li> <li>■ GSV flow</li> <li>■ GSV flow alternative</li> <li>■ NSV flow</li> <li>■ NSV flow alternative</li> <li>■ S&amp;W volume flow</li> <li>■ Oil mass flow</li> <li>■ Water mass flow</li> <li>■ Oil volume flow</li> <li>■ Water volume flow</li> <li>■ Oil corrected volume flow</li> <li>■ Water corrected volume flow</li> </ul>	–
Unit totalizer	Select the unit for the process variable of the totalizer.	Unit choose list	Country-specific: <ul style="list-style-type: none"> <li>■ kg</li> <li>■ lb</li> </ul>
Totalizer operation mode	Select totalizer calculation mode.	<ul style="list-style-type: none"> <li>■ Net flow total</li> <li>■ Forward flow total</li> <li>■ Reverse flow total</li> <li>■ Last valid value</li> </ul>	–
Failure mode	Define the totalizer behavior in the event of a device alarm.	<ul style="list-style-type: none"> <li>■ Stop</li> <li>■ Actual value</li> <li>■ Last valid value</li> </ul>	–

### 10.7.4 Carrying out additional display configurations

In the **Display** submenu you can set all the parameters associated with the configuration of the local display.

#### Navigation

"Setup" menu → Advanced setup → Display

► Display	
Format display	→  137
Value 1 display	→  137
0% bargraph value 1	→  137
100% bargraph value 1	→  137
Decimal places 1	→  137
Value 2 display	→  138
Decimal places 2	→  138
Value 3 display	→  138
0% bargraph value 3	→  138
100% bargraph value 3	→  138
Decimal places 3	→  138
Value 4 display	→  138
Decimal places 4	→  138
Display language	→  138
Display interval	→  138
Display damping	→  138
Header	→  138
Header text	→  139
Separator	→  139
Backlight	→  139

## Parameter overview with brief description

Parameter	Prerequisite	Description	Selection / User entry	Factory setting
Format display	A local display is provided.	Select how measured values are shown on the display.	<ul style="list-style-type: none"> <li>■ 1 value, max. size</li> <li>■ 1 bargraph + 1 value</li> <li>■ 2 values</li> <li>■ 1 value large + 2 values</li> <li>■ 4 values</li> </ul>	–
Value 1 display	A local display is provided.	Select the measured value that is shown on the local display.	<ul style="list-style-type: none"> <li>■ Mass flow</li> <li>■ Volume flow</li> <li>■ Corrected volume flow</li> <li>■ Target mass flow *</li> <li>■ Carrier mass flow *</li> <li>■ Target volume flow *</li> <li>■ Carrier volume flow *</li> <li>■ Target corrected volume flow *</li> <li>■ Carrier corrected volume flow *</li> <li>■ Density</li> <li>■ Reference density *</li> <li>■ Concentration *</li> <li>■ Temperature</li> <li>■ Carrier pipe temperature *</li> <li>■ Electronic temperature</li> <li>■ Oscillation frequency 0</li> <li>■ Oscillation amplitude 0 *</li> <li>■ Frequency fluctuation 0</li> <li>■ Oscillation damping 0</li> <li>■ Oscillation damping fluctuation 0</li> <li>■ Signal asymmetry</li> <li>■ Exciter current 0</li> <li>■ Totalizer 1</li> <li>■ Totalizer 2</li> <li>■ Totalizer 3</li> <li>■ Current output 1</li> <li>■ Current output 2 *</li> <li>■ Current output 3 *</li> <li>■ Current output 4 *</li> <li>■ Pressure</li> </ul>	–
0% bargraph value 1	A local display is provided.	Enter 0% value for bar graph display.	Signed floating-point number	Country-specific: <ul style="list-style-type: none"> <li>■ 0 kg/h</li> <li>■ 0 lb/min</li> </ul>
100% bargraph value 1	A local display is provided.	Enter 100% value for bar graph display.	Signed floating-point number	Depends on country and nominal diameter
Decimal places 1	A measured value is specified in the <b>Value 1 display</b> parameter.	Select the number of decimal places for the display value.	<ul style="list-style-type: none"> <li>■ x</li> <li>■ x.x</li> <li>■ x.xx</li> <li>■ x.xxx</li> <li>■ x.xxxx</li> </ul>	–

Parameter	Prerequisite	Description	Selection / User entry	Factory setting
Value 2 display	A local display is provided.	Select the measured value that is shown on the local display.	For the picklist, see the <b>Value 1 display</b> parameter (→ 127)	–
Decimal places 2	A measured value is specified in the <b>Value 2 display</b> parameter.	Select the number of decimal places for the display value.	<ul style="list-style-type: none"> <li>▪ x</li> <li>▪ x.x</li> <li>▪ x.xx</li> <li>▪ x.xxx</li> <li>▪ x.xxxx</li> </ul>	–
Value 3 display	A local display is provided.	Select the measured value that is shown on the local display.	For the picklist, see the <b>Value 1 display</b> parameter (→ 127)	–
0% bargraph value 3	A selection was made in the <b>Value 3 display</b> parameter.	Enter 0% value for bar graph display.	Signed floating-point number	Country-specific: <ul style="list-style-type: none"> <li>▪ 0 kg/h</li> <li>▪ 0 lb/min</li> </ul>
100% bargraph value 3	A selection was made in the <b>Value 3 display</b> parameter.	Enter 100% value for bar graph display.	Signed floating-point number	–
Decimal places 3	A measured value is specified in the <b>Value 3 display</b> parameter.	Select the number of decimal places for the display value.	<ul style="list-style-type: none"> <li>▪ x</li> <li>▪ x.x</li> <li>▪ x.xx</li> <li>▪ x.xxx</li> <li>▪ x.xxxx</li> </ul>	–
Value 4 display	A local display is provided.	Select the measured value that is shown on the local display.	For the picklist, see the <b>Value 1 display</b> parameter (→ 127)	–
Decimal places 4	A measured value is specified in the <b>Value 4 display</b> parameter.	Select the number of decimal places for the display value.	<ul style="list-style-type: none"> <li>▪ x</li> <li>▪ x.x</li> <li>▪ x.xx</li> <li>▪ x.xxx</li> <li>▪ x.xxxx</li> </ul>	–
Display language	A local display is provided.	Set display language.	<ul style="list-style-type: none"> <li>▪ English</li> <li>▪ Deutsch *</li> <li>▪ Français *</li> <li>▪ Español *</li> <li>▪ Italiano *</li> <li>▪ Nederlands *</li> <li>▪ Portuguesa *</li> <li>▪ Polski *</li> <li>▪ русский язык (Russian) *</li> <li>▪ Svenska *</li> <li>▪ Türkçe *</li> <li>▪ 中文 (Chinese) *</li> <li>▪ 日本語 (Japanese) *</li> <li>▪ 한국어 (Korean) *</li> <li>▪ Bahasa Indonesia *</li> <li>▪ tiếng Việt (Vietnamese) *</li> <li>▪ čeština (Czech) *</li> </ul>	English (alternatively, the ordered language is preset in the device)
Display interval	A local display is provided.	Set time measured values are shown on display if display alternates between values.	1 to 10 s	–
Display damping	A local display is provided.	Set display reaction time to fluctuations in the measured value.	0.0 to 999.9 s	–
Header	A local display is provided.	Select header contents on local display.	<ul style="list-style-type: none"> <li>▪ Device tag</li> <li>▪ Free text</li> </ul>	–

Parameter	Prerequisite	Description	Selection / User entry	Factory setting
Header text	In the <b>Header</b> parameter, the <b>Free text</b> option is selected.	Enter display header text.	Max. 12 characters such as letters, numbers or special characters (e.g. @, %, /)	-
Separator	A local display is provided.	Select decimal separator for displaying numerical values.	<ul style="list-style-type: none"> <li>▪ . (point)</li> <li>▪ , (comma)</li> </ul>	. (point)
Backlight	One of the following conditions is met: <ul style="list-style-type: none"> <li>▪ Order code for "Display; operation", option <b>F</b> "4-line, illum.; touch control"</li> <li>▪ Order code for "Display; operation", option <b>G</b> "4-line, illum.; touch control +WLAN"</li> </ul>	Switch the local display backlight on and off.	<ul style="list-style-type: none"> <li>▪ Disable</li> <li>▪ Enable</li> </ul>	-

\* Visibility depends on order options or device settings

### 10.7.5 WLAN configuration

The **WLAN Settings** submenu guides the user systematically through all the parameters that have to be set for the WLAN configuration.



#### Navigation

"Setup" menu → Advanced setup → WLAN Settings

▶ **WLAN settings**

WLAN IP address	→ ⓘ 140
Security type	→ ⓘ 140
WLAN passphrase	→ ⓘ 140
Assign SSID name	→ ⓘ 140
SSID name	→ ⓘ 140
Apply changes	→ ⓘ 140

**Parameter overview with brief description**

Parameter	Prerequisite	Description	User entry / Selection	Factory setting
WLAN IP address	-	Enter IP address of the device WLAN interface.	4 octet: 0 to 255 (in the particular octet)	-
Network security	-	Select the security type of the WLAN network.	<ul style="list-style-type: none"> <li>▪ Unsecured</li> <li>▪ WPA2-PSK</li> <li>▪ EAP-PEAP with MSCHAPv2</li> <li>▪ EAP-PEAP MSCHAPv2 no server authentic.</li> <li>▪ EAP-TLS</li> </ul>	-
WLAN passphrase	The <b>WPA2-PSK</b> option is selected in the <b>Security type</b> parameter.	Enter the network key (8 to 32 characters).  The network key supplied with the device should be changed during commissioning for security reasons.	8 to 32-digit character string comprising numbers, letters and special characters	Serial number of the measuring device (e.g. L100A802000)
Assign SSID name	-	Select which name will be used for SSID: device tag or user-defined name.	<ul style="list-style-type: none"> <li>▪ Device tag</li> <li>▪ User-defined</li> </ul>	-
SSID name	<ul style="list-style-type: none"> <li>▪ The <b>User-defined</b> option is selected in the <b>Assign SSID name</b> parameter parameter.</li> <li>▪ The <b>WLAN access point</b> option is selected in the <b>WLAN mode</b> parameter parameter.</li> </ul>	Enter the user-defined SSID name (max. 32 characters).  The user-defined SSID name may only be assigned once. If the SSID name is assigned more than once, the devices can interfere with one another.	Max. 32-digit character string comprising numbers, letters and special characters	EH_device designation_last 7 digits of the serial number (e.g. EH_Promass_500_A 802000)
Apply changes	-	Use changed WLAN settings.	<ul style="list-style-type: none"> <li>▪ Cancel</li> <li>▪ Ok</li> </ul>	-

**10.7.6 Configuration management**

After commissioning, you can save the current device configuration or restore the previous device configuration.



You can do so using the **Configuration management** parameter and the related options found in the **Configuration backup** submenu.

**Navigation**

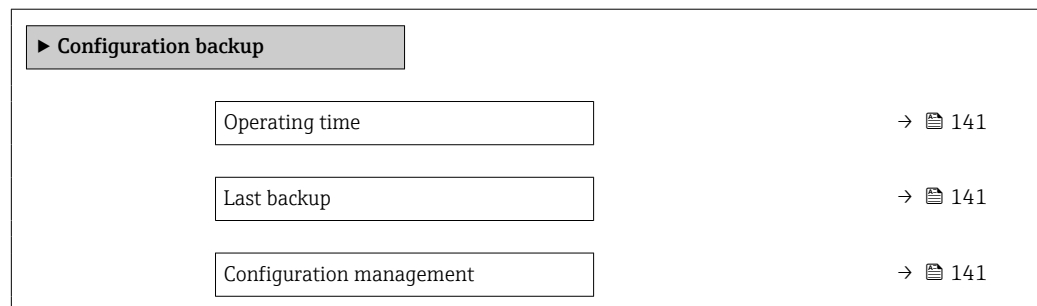
"Setup" menu → Advanced setup → Configuration backup





Backup state	→  141
Comparison result	→  141

### Parameter overview with brief description

Parameter	Description	User interface / Selection
Operating time	Indicates how long the device has been in operation.	Days (d), hours (h), minutes (m) and seconds (s)
Last backup	Shows when the last data backup was saved to HistoROM backup.	Days (d), hours (h), minutes (m) and seconds (s)
Configuration management	Select action for managing the device data in the HistoROM backup.	<ul style="list-style-type: none"> <li>■ Cancel</li> <li>■ Execute backup</li> <li>■ Restore</li> <li>■ Compare</li> <li>■ Clear backup data</li> </ul>
Backup state	Shows the current status of data saving or restoring.	<ul style="list-style-type: none"> <li>■ None</li> <li>■ Backup in progress</li> <li>■ Restoring in progress</li> <li>■ Delete in progress</li> <li>■ Compare in progress</li> <li>■ Restoring failed</li> <li>■ Backup failed</li> </ul>
Comparison result	Comparison of current device data with HistoROM backup.	<ul style="list-style-type: none"> <li>■ Settings identical</li> <li>■ Settings not identical</li> <li>■ No backup available</li> <li>■ Backup settings corrupt</li> <li>■ Check not done</li> <li>■ Dataset incompatible</li> </ul>

### Function scope of the "Configuration management" parameter

Options	Description
Cancel	No action is executed and the user exits the parameter.
Execute backup	A backup copy of the current device configuration is saved from the HistoROM backup to the memory of the device. The backup copy includes the transmitter data of the device.
Restore	The last backup copy of the device configuration is restored from the device memory to the device's HistoROM backup. The backup copy includes the transmitter data of the device.
Compare	The device configuration saved in the device memory is compared with the current device configuration of the HistoROM backup.
Clear backup data	The backup copy of the device configuration is deleted from the memory of the device.



#### *HistoROM backup*

A HistoROM is a "non-volatile" device memory in the form of an EEPROM.



While this action is in progress, the configuration cannot be edited via the local display and a message on the processing status appears on the display.

### 10.7.7 Using parameters for device administration

The **Administration** submenu systematically guides the user through all the parameters that can be used for device administration purposes.

**Navigation**

"Setup" menu → Advanced setup → Administration

▶ Administration

▶ Define access code → ⓘ 142

▶ Reset access code → ⓘ 142

Device reset → ⓘ 143

**Using the parameter to define the access code**

**Navigation**

"Setup" menu → Advanced setup → Administration → Define access code

▶ Define access code

Define access code → ⓘ 142

Confirm access code → ⓘ 142

**Parameter overview with brief description**

Parameter	Description	User entry
Define access code	Restrict write-access to parameters to protect the configuration of the device against unintentional changes.	Max. 16-digit character string comprising numbers, letters and special characters
Confirm access code	Confirm the entered access code.	Max. 16-digit character string comprising numbers, letters and special characters

**Using the parameter to reset the access code**

**Navigation**

"Setup" menu → Advanced setup → Administration → Reset access code

▶ Reset access code

Operating time → ⓘ 143

Reset access code → ⓘ 143

**Parameter overview with brief description**

Parameter	Description	User interface / User entry
Operating time	Indicates how long the device has been in operation.	Days (d), hours (h), minutes (m) and seconds (s)
Reset access code	Reset access code to factory settings.  For a reset code, contact your Endress+Hauser service organization. The reset code can only be entered via: <ul style="list-style-type: none"> <li>▪ Web browser</li> <li>▪ DeviceCare, FieldCare (via service interface CDI-RJ45)</li> <li>▪ Fieldbus</li> </ul>	Character string comprising numbers, letters and special characters

**Using the parameter to reset the device**

**Navigation**

"Setup" menu → Advanced setup → Administration

**Parameter overview with brief description**

Parameter	Description	Selection
Device reset	Reset the device configuration - either entirely or in part - to a defined state.	<ul style="list-style-type: none"> <li>▪ Cancel</li> <li>▪ To delivery settings</li> <li>▪ Restart device</li> <li>▪ Restore S-DAT backup</li> </ul>

## 10.8 Simulation

The **Simulation** submenu enables you to simulate, without a real flow situation, various process variables in the process and the device alarm mode and to verify downstream signal chains (switching valves or closed-control loops).

**Navigation**



"Diagnostics" menu → Simulation

► Simulation	
Assign simulation process variable	→ 144
Process variable value	→ 144
Status input simulation	→ 144
Input signal level	→ 144
Current input 1 to n simulation	→ 144
Value current input 1 to n	→ 145
Current output 1 to n simulation	→ 145

Value current output 1 to n	→  145
Frequency output simulation 1 to n	→  145
Frequency value 1 to n	→  145
Pulse output simulation 1 to n	→  145
Pulse value 1 to n	→  145
Switch output simulation 1 to n	→  145
Switch status 1 to n	→  145
Relay output 1 to n simulation	→  145
Switch status 1 to n	→  145
Device alarm simulation	→  145
Diagnostic event category	→  145
Diagnostic event simulation	→  145

### Parameter overview with brief description



Parameter	Prerequisite	Description	Selection / User entry / User interface
Assign simulation process variable	–	Select a process variable for the simulation process that is activated.	<ul style="list-style-type: none"> <li>▪ Off</li> <li>▪ Mass flow</li> <li>▪ Volume flow</li> <li>▪ Corrected volume flow</li> <li>▪ Target mass flow *</li> <li>▪ Carrier mass flow *</li> <li>▪ Target volume flow *</li> <li>▪ Carrier volume flow *</li> <li>▪ Target corrected volume flow *</li> <li>▪ Carrier corrected volume flow *</li> <li>▪ Density</li> <li>▪ Reference density</li> <li>▪ Temperature</li> <li>▪ Concentration *</li> </ul>
Process variable value	A process variable is selected in the <b>Assign simulation process variable</b> parameter (→  144).	Enter the simulation value for the selected process variable.	Depends on the process variable selected
Status input simulation	–	Switch simulation of the status input on and off.	<ul style="list-style-type: none"> <li>▪ Off</li> <li>▪ On</li> </ul>
Input signal level	In the <b>Status input simulation</b> parameter, the <b>On</b> option is selected.	Select the signal level for the simulation of the status input.	<ul style="list-style-type: none"> <li>▪ High</li> <li>▪ Low</li> </ul>
Current input 1 to n simulation	–	Switch simulation of the current input on and off.	<ul style="list-style-type: none"> <li>▪ Off</li> <li>▪ On</li> </ul>

Parameter	Prerequisite	Description	Selection / User entry / User interface
Value current input 1 to n	In the <b>Current input 1 to n simulation</b> parameter, the <b>On</b> option is selected.	Enter the current value for simulation.	0 to 22.5 mA
Current output 1 to n simulation	–	Switch the simulation of the current output on and off.	<ul style="list-style-type: none"> <li>■ Off</li> <li>■ On</li> </ul>
Value current output 1 to n	In the <b>Current output 1 to n simulation</b> parameter, the <b>On</b> option is selected.	Enter the current value for simulation.	3.59 to 22.5 mA
Frequency output simulation 1 to n	In the <b>Operating mode</b> parameter, the <b>Frequency</b> option is selected.	Switch the simulation of the frequency output on and off.	<ul style="list-style-type: none"> <li>■ Off</li> <li>■ On</li> </ul>
Frequency value 1 to n	In the <b>Frequency output simulation 1 to n</b> parameter, the <b>On</b> option is selected.	Enter the frequency value for the simulation.	0.0 to 12 500.0 Hz
Pulse output simulation 1 to n	In the <b>Operating mode</b> parameter, the <b>Pulse</b> option is selected.	Set and switch off the pulse output simulation.  For <b>Fixed value</b> option: <b>Pulse width</b> parameter (→  118) defines the pulse width of the pulses output.	<ul style="list-style-type: none"> <li>■ Off</li> <li>■ Fixed value</li> <li>■ Down-counting value</li> </ul>
Pulse value 1 to n	In the <b>Pulse output simulation 1 to n</b> parameter, the <b>Down-counting value</b> option is selected.	Enter the number of pulses for simulation.	0 to 65 535
Switch output simulation 1 to n	In the <b>Operating mode</b> parameter, the <b>Switch</b> option is selected.	Switch the simulation of the switch output on and off.	<ul style="list-style-type: none"> <li>■ Off</li> <li>■ On</li> </ul>
Switch status 1 to n	–	Select the status of the status output for the simulation.	<ul style="list-style-type: none"> <li>■ Open</li> <li>■ Closed</li> </ul>
Relay output 1 to n simulation	–	Switch simulation of the relay output on and off.	<ul style="list-style-type: none"> <li>■ Off</li> <li>■ On</li> </ul>
Switch status 1 to n	The <b>On</b> option is selected in the <b>Switch output simulation 1 to n</b> parameter parameter.	Select status of the relay output for the simulation.	<ul style="list-style-type: none"> <li>■ Open</li> <li>■ Closed</li> </ul>
Pulse output simulation	–	Set and switch off the pulse output simulation.  For <b>Fixed value</b> option: <b>Pulse width</b> parameter defines the pulse width of the pulses output.	<ul style="list-style-type: none"> <li>■ Off</li> <li>■ Fixed value</li> <li>■ Down-counting value</li> </ul>
Pulse value	In the <b>Pulse output simulation</b> parameter, the <b>Down-counting value</b> option is selected.	Set and switch off the pulse output simulation.	0 to 65 535
Device alarm simulation	–	Switch the device alarm on and off.	<ul style="list-style-type: none"> <li>■ Off</li> <li>■ On</li> </ul>
Diagnostic event category	–	Select a diagnostic event category.	<ul style="list-style-type: none"> <li>■ Sensor</li> <li>■ Electronics</li> <li>■ Configuration</li> <li>■ Process</li> </ul>
Diagnostic event simulation	–	Select a diagnostic event to simulate this event.	<ul style="list-style-type: none"> <li>■ Off</li> <li>■ Diagnostic event picklist (depends on the category selected)</li> </ul>
Logging interval	–	Define the logging interval tlog for data logging. This value defines the time interval between the individual data points in the memory.	1.0 to 3 600.0 s

\* Visibility depends on order options or device settings

## 10.9 Protecting settings from unauthorized access

The following write protection options exist in order to protect the configuration of the measuring device from unintentional modification:



- Protect access to parameters via access code →  146
- Protect access to local operation via key locking →  75
- Protect access to measuring device via write protection switch →  147

### 10.9.1 Write protection via access code

The effects of the user-specific access code are as follows:



- Via local operation, the parameters for the measuring device configuration are write-protected and their values can no longer be changed.
- Device access is protected via the Web browser, as are the parameters for the measuring device configuration.
- Device access is protected via FieldCare or DeviceCare (via CDI-RJ45 service interface), as are the parameters for the measuring device configuration.

#### Defining the access code via local display

1. Navigate to the **Define access code** parameter (→  142).
2. Define a max. 16-digit character string comprising numbers, letters and special characters as the access code.
3. Enter the access code again in the **Confirm access code** parameter (→  142) to confirm the code.

↳ The -symbol appears in front of all write-protected parameters.

The device automatically locks the write-protected parameters again if a key is not pressed for 10 minutes in the navigation and editing view. The device locks the write-protected parameters automatically after 60 s if the user skips back to the operational display mode from the navigation and editing view.

-  If parameter write protection is activated via an access code, it can also only be deactivated via this access code →  74.
  - The user role with which the user is currently logged on via the local display is indicated by the →  74 **Access status** parameter. Navigation path: Operation → Access status



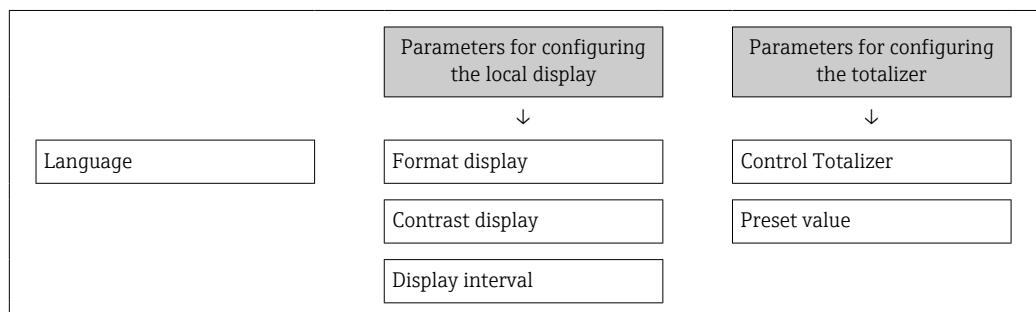

#### Parameters which can always be modified via the local display

Certain parameters that do not affect the measurement are excepted from parameter write protection via the local display. Despite the user-specific access code, they can always be modified, even if the other parameters are locked.



#### Defining the access code via the Web browser



1. Navigate to the **Define access code** parameter (→  142).
2. Define a max. 16-digit numeric code as an access code.

3. Enter the access code again in the **Confirm access code** parameter (→  142) to confirm the code.
    - ↳ The Web browser switches to the login page.
-  If no action is performed for 10 minutes, the Web browser automatically returns to the login page.
- 
  - If parameter write protection is activated via an access code, it can also only be deactivated via this access code →  74.
  - The user role with which the user is currently logged on via Web browser is indicated by the **Access status** parameter. Navigation path: Operation → Access status

### Resetting the access code

If you misplace the user-specific access code, it is possible to reset the code to the factory setting. A reset code must be entered for this purpose. The user-specific access code can then be defined again afterwards.

#### Via Web browser, FieldCare, DeviceCare (via CDI-RJ45 service interface), fieldbus

-  For a reset code, contact your Endress+Hauser service organization.
1. Navigate to the **Reset access code** parameter (→  143).
  2. Enter the reset code.
    - ↳ The access code has been reset to the factory setting **0000**. It can be redefined →  146.

### 10.9.2 Write protection via write protection switch

Unlike parameter write protection via a user-specific access code, this allows write access to the entire operating menu - except for the **"Contrast display" parameter** - to be locked.

The parameter values are now read only and cannot be edited any more (exception **"Contrast display" parameter**):

- Via local display
- Via PROFIBUS DP protocol

#### Proline 500 – digital

##### **WARNING**

#### **Excessive tightening torque applied to the fixing screws!**

Risk of damaging the plastic transmitter.

- ▶ Tighten the fixing screws as per the tightening torque: 2 Nm (1.5 lbf ft)

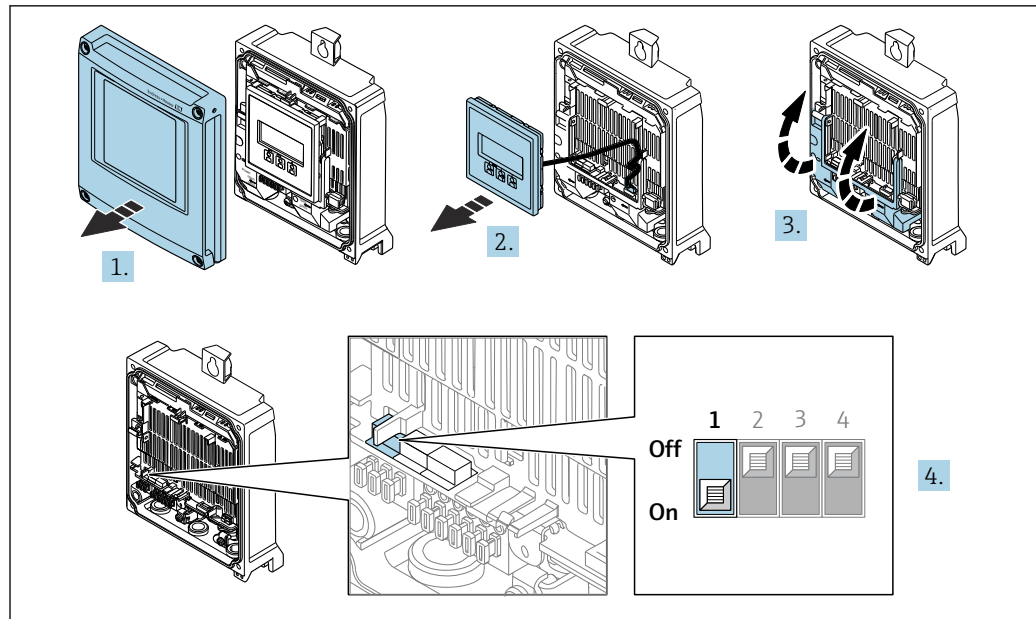

A0029673

1. Open the housing cover.
2. Remove the display module.
3. Fold open the terminal cover.
4. Setting the write protection (WP) switch on the main electronics module to the **ON** position enables hardware write protection.
  - ↳ In the **Locking status** parameter the **Hardware locked** option is displayed → 150. In addition, on the local display the -symbol appears in front of the parameters in the header of the operational display and in the navigation view.

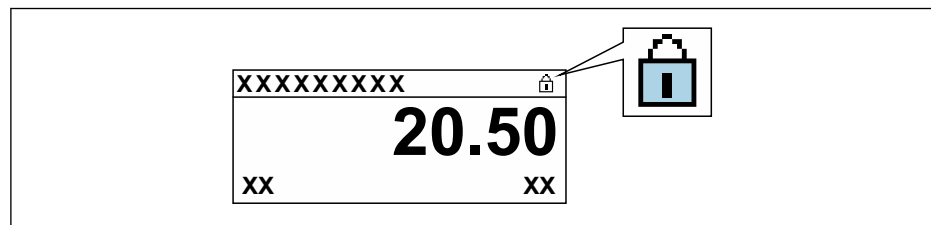

A0029425

5. Setting the write protection (WP) switch on the main electronics module to the **OFF** position (factory setting) disables hardware write protection.
  - ↳ No option is displayed in the **Locking status** parameter → 150. On the local display, the -symbol disappears from in front of the parameters in the header of the operational display and in the navigation view.



**Proline 500**

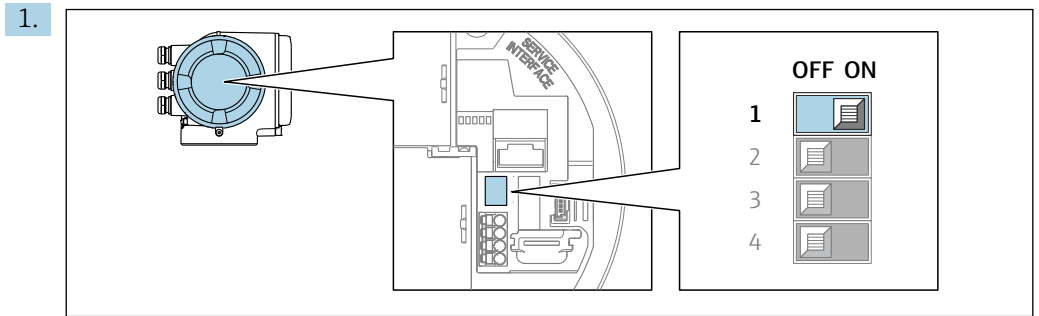

Setting the write protection (WP) switch on the main electronics module to the **ON** position enables hardware write protection.

- ↳ In the **Locking status** parameter the **Hardware locked** option is displayed → 150. In addition, on the local display the -symbol appears in front of the parameters in the header of the operational display and in the navigation view.

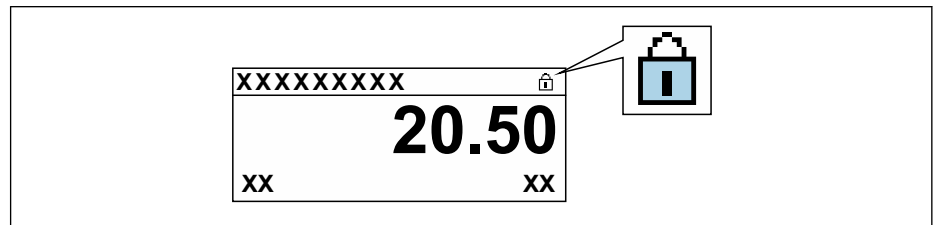

2. Setting the write protection (WP) switch on the main electronics module to the **OFF** position (factory setting) disables hardware write protection.

- ↳ No option is displayed in the **Locking status** parameter → 150. On the local display, the -symbol disappears from in front of the parameters in the header of the operational display and in the navigation view.

# 11 Operation

## 11.1 Reading the device locking status

Device active write protection: **Locking status** parameter

Operation → Locking status

*Function scope of the "Locking status" parameter*

Options	Description
None	The access status displayed in the <b>Access status</b> parameter applies → 74. Only appears on local display.
Hardware locked	The DIP switch for hardware locking is activated on the PCB board. This locks write access to the parameters (e.g. via local display or operating tool) .
Temporarily locked	Write access to the parameters is temporarily locked on account of internal processes running in the device (e.g. data upload/download, reset etc.). Once the internal processing has been completed, the parameters can be changed once again.

## 11.2 Adjusting the operating language

**i** Detailed information:

- To configure the operating language → 102
- For information on the operating languages supported by the measuring device → 259

## 11.3 Configuring the display

Detailed information:

- On the basic settings for the local display → 126
- On the advanced settings for the local display → 136

## 11.4 Reading measured values

With the **Measured values** submenu, it is possible to read all the measured values.

### Navigation

"Diagnostics" menu → Measured values

▶ Measured values	
▶ Measured variables	→ 151
▶ Input values	→ 153
▶ Output values	→ 154
▶ Totalizer 1 to n	→ 152

### 11.4.1 "Measured variables" submenu

The **Measured variables** submenu contains all the parameters needed to display the current measured values for each process variable.





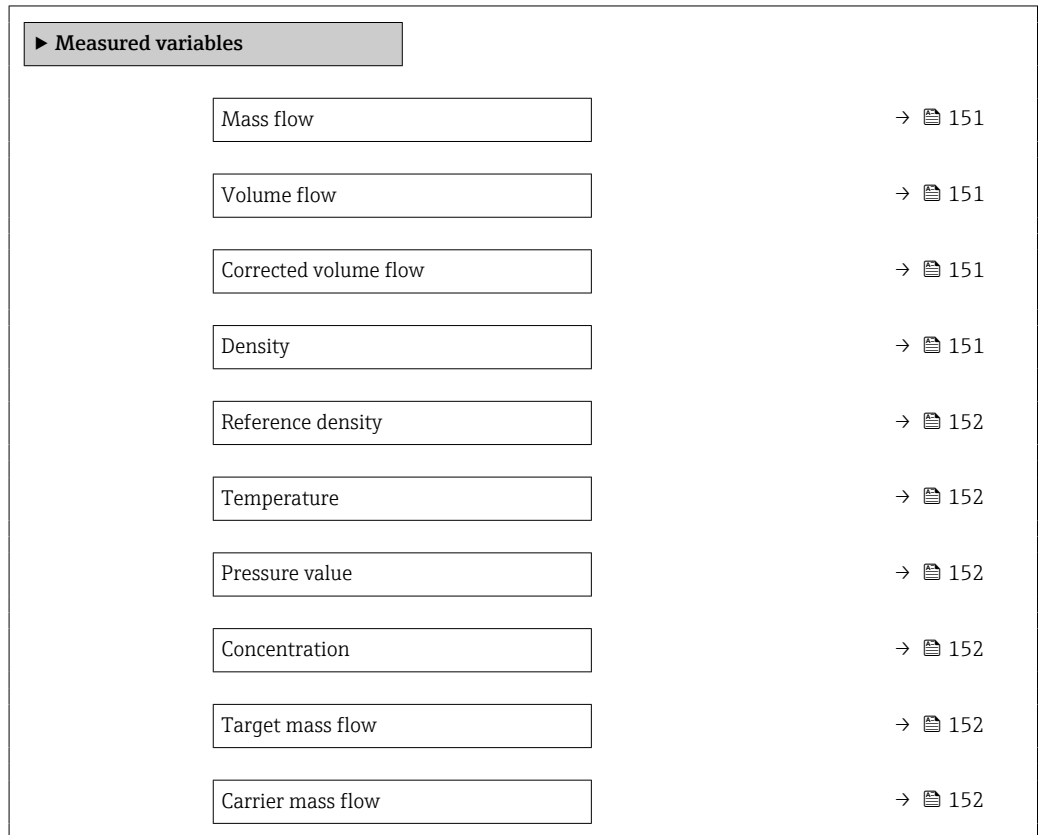



#### Navigation

"Diagnostics" menu → Measured values → Measured variables



#### Parameter overview with brief description

Parameter	Prerequisite	Description	User interface
Mass flow	–	Displays the mass flow currently measured. <i>Dependency</i> The unit is taken from the <b>Mass flow unit</b> parameter (→ 106).	Signed floating-point number
Volume flow	–	Displays the volume flow currently calculated. <i>Dependency</i> The unit is taken from the <b>Volume flow unit</b> parameter (→ 106).	Signed floating-point number
Corrected volume flow	–	Displays the corrected volume flow currently calculated. <i>Dependency</i> The unit is taken from the <b>Corrected volume flow unit</b> parameter (→ 106).	Signed floating-point number
Density	–	Shows the density currently measured. <i>Dependency</i> The unit is taken from the <b>Density unit</b> parameter (→ 106).	Signed floating-point number





Parameter	Prerequisite	Description	User interface
Reference density	–	Displays the reference density currently calculated. <i>Dependency</i> The unit is taken from the <b>Reference density unit</b> parameter (→  106).	Signed floating-point number
Temperature	–	Shows the medium temperature currently measured. <i>Dependency</i> The unit is taken from the <b>Temperature unit</b> parameter (→  107).	Signed floating-point number
Pressure value	–	Displays either a fixed or external pressure value. <i>Dependency</i> The unit is taken from the <b>Pressure unit</b> parameter (→  107).	Signed floating-point number
Concentration	For the following order code: Order code for "Application package", option <b>ED</b> "Concentration"  The software options currently enabled are displayed in the <b>Software option overview</b> parameter.	Displays the concentration currently calculated. <i>Dependency</i> The unit is taken from the <b>Concentration unit</b> parameter.	Signed floating-point number
Target mass flow	With the following conditions: Order code for "Application package", option <b>ED</b> "Concentration"  The software options currently enabled are displayed in the <b>Software option overview</b> parameter.	Displays the mass flow currently measured for the target medium. <i>Dependency</i> The unit is taken from the <b>Mass flow unit</b> parameter (→  106).	Signed floating-point number
Carrier mass flow	With the following conditions: Order code for "Application package", option <b>ED</b> "Concentration"  The software options currently enabled are displayed in the <b>Software option overview</b> parameter.	Displays the mass flow currently measured for the carrier medium. <i>Dependency</i> The unit is taken from the <b>Mass flow unit</b> parameter (→  106).	Signed floating-point number

### 11.4.2 Totalizer

The **Totalizer** submenu contains all the parameters needed to display the current measured values for every totalizer.

#### Navigation

"Diagnostics" menu → Measured values → Totalizer 1 to n

▶ <b>Totalizer 1 to n</b>	
Assign process variable	→  153
Totalizer value 1 to n	→  153
Totalizer status 1 to n	→  153
Totalizer status (Hex) 1 to n	→  153

**Parameter overview with brief description**

Parameter	Prerequisite	Description	Selection / User entry / User interface
Assign process variable	–	Select process variable for totalizer.	<ul style="list-style-type: none"> <li>■ Mass flow</li> <li>■ Volume flow</li> <li>■ Corrected volume flow</li> <li>■ Target mass flow</li> <li>■ Carrier mass flow</li> <li>■ Target volume flow</li> <li>■ Carrier volume flow</li> <li>■ Target corrected volume flow</li> <li>■ Carrier corrected volume flow</li> <li>■ GSV flow</li> <li>■ GSV flow alternative</li> <li>■ NSV flow</li> <li>■ NSV flow alternative</li> <li>■ S&amp;W volume flow</li> <li>■ Oil mass flow</li> <li>■ Water mass flow</li> <li>■ Oil volume flow</li> <li>■ Water volume flow</li> <li>■ Oil corrected volume flow</li> <li>■ Water corrected volume flow</li> </ul>
Totalizer value 1 to n	In the <b>Assign process variable</b> parameter one of the following options is selected: <ul style="list-style-type: none"> <li>■ Volume flow</li> <li>■ Mass flow</li> <li>■ Corrected volume flow</li> <li>■ Total mass flow</li> <li>■ Condensate mass flow</li> <li>■ Energy flow</li> <li>■ Heat flow difference</li> </ul>	Displays the current totalizer counter value.	Signed floating-point number
Totalizer status 1 to n	–	Displays the current totalizer status.	<ul style="list-style-type: none"> <li>■ Good</li> <li>■ Uncertain</li> <li>■ Bad</li> </ul>
Totalizer status (Hex) 1 to n	In <b>Target mode</b> parameter, the <b>Auto</b> option is selected.	Displays the current status value (hex) of the totalizer.	0 to 0xFF

**11.4.3 "Input values" submenu**

The **Input values** submenu guides you systematically to the individual input values.

**Navigation**

"Diagnostics" menu → Measured values → Input values

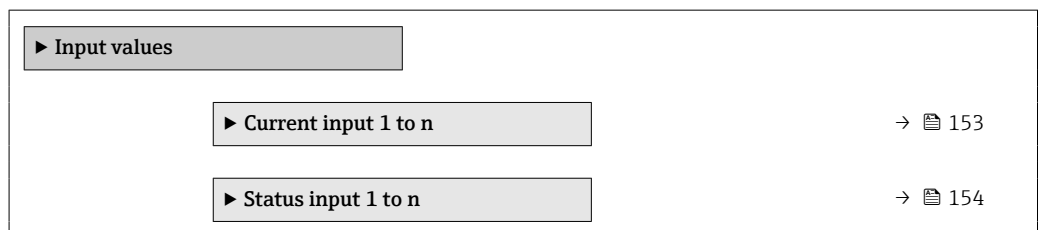

**Input values of current input**

The **Current input 1 to n** submenu contains all the parameters needed to display the current measured values for every current input.

**Navigation**

"Diagnostics" menu → Measured values → Input values → Current input 1 to n

▶ Current input 1 to n

Measured values 1 to n

→ 154

Measured current 1 to n

→ 154

**Parameter overview with brief description**

Parameter	Description	User interface
Measured values 1 to n	Displays the current input value.	Signed floating-point number
Measured current 1 to n	Displays the current value of the current input.	0 to 22.5 mA

**Input values of status input**

The **Status input 1 to n** submenu contains all the parameters needed to display the current measured values for every status input.

**Navigation**

"Diagnostics" menu → Measured values → Input values → Status input 1 to n

▶ Status input 1 to n

Value status input

→ 154

**Parameter overview with brief description**

Parameter	Description	User interface
Value status input	Shows the current input signal level.	<ul style="list-style-type: none"> <li>▪ High</li> <li>▪ Low</li> </ul>

**11.4.4 Output values**

The **Output values** submenu contains all the parameters needed to display the current measured values for every output.

**Navigation**

"Diagnostics" menu → Measured values → Output values

▶ Output values

▶ Current output 1 to n

→ 155

▶ Pulse/frequency/switch output 1 to n	→ 155
▶ Relay output 1 to n	→ 156

### Output values of current output

The **Value current output** submenu contains all the parameters needed to display the current measured values for every current output.

#### Navigation

"Diagnostics" menu → Measured values → Output values → Value current output 1 to n

▶ Current output 1 to n	
Output current 1 to n	→ 155
Measured current 1 to n	→ 155

### Parameter overview with brief description

Parameter	Description	User interface
Output current 1	Displays the current value currently calculated for the current output.	3.59 to 22.5 mA
Measured current	Displays the current value currently measured for the current output.	0 to 30 mA

### Output values for pulse/frequency/switch output

The **Pulse/frequency/switch output 1 to n** submenu contains all the parameters needed to display the current measured values for every pulse/frequency/switch output.

#### Navigation

"Diagnostics" menu → Measured values → Output values → Pulse/frequency/switch output 1 to n

▶ Pulse/frequency/switch output 1 to n	
Output frequency 1 to n	→ 156
Pulse output 1 to n	→ 156
Switch status 1 to n	→ 156

**Parameter overview with brief description**

Parameter	Prerequisite	Description	User interface
Output frequency 1 to n	In the <b>Operating mode</b> parameter, the <b>Frequency</b> option is selected.	Displays the value currently measured for the frequency output.	0.0 to 12 500.0 Hz
Pulse output 1 to n	The <b>Pulse</b> option is selected in the <b>Operating mode</b> parameter parameter.	Displays the pulse frequency currently output.	Positive floating-point number
Switch status 1 to n	The <b>Switch</b> option is selected in the <b>Operating mode</b> parameter.	Displays the current switch output status.	<ul style="list-style-type: none"> <li>▪ Open</li> <li>▪ Closed</li> </ul>

**Output values for relay output**

The **Relay output 1 to n** submenu contains all the parameters needed to display the current measured values for every relay output.

**Navigation**

"Diagnostics" menu → Measured values → Output values → Relay output 1 to n

▶ Relay output 1 to n		
Switch status	→	📖 156
Switch cycles	→	📖 156
Max. switch cycles number	→	📖 156

**Parameter overview with brief description**

Parameter	Description	User interface
Switch status	Shows the current relay switch status.	<ul style="list-style-type: none"> <li>▪ Open</li> <li>▪ Closed</li> </ul>
Switch cycles	Shows number of all performed switch cycles.	Positive integer
Max. switch cycles number	Shows the maximal number of guaranteed switch cycles.	Positive integer

**11.5 Adapting the measuring device to the process conditions**

The following are available for this purpose:

- Basic settings using the **Setup** menu (→ 📖 103)
- Advanced settings using the **Advanced setup** submenu (→ 📖 131)

**11.6 Performing a totalizer reset**

The totalizers are reset in the **Operation** submenu:  
Control Totalizer 1 to n



Function scope of the "Control Totalizer" parameter

Options	Description
Totalize	The totalizer is started.
Reset + hold	The totaling process is stopped and the totalizer is reset to 0.
Preset + hold	The totaling process is stopped and the totalizer is set to its defined start value from the <b>Preset value 1 to n</b> parameter.

Navigation

"Operation" menu → Totalizer handling

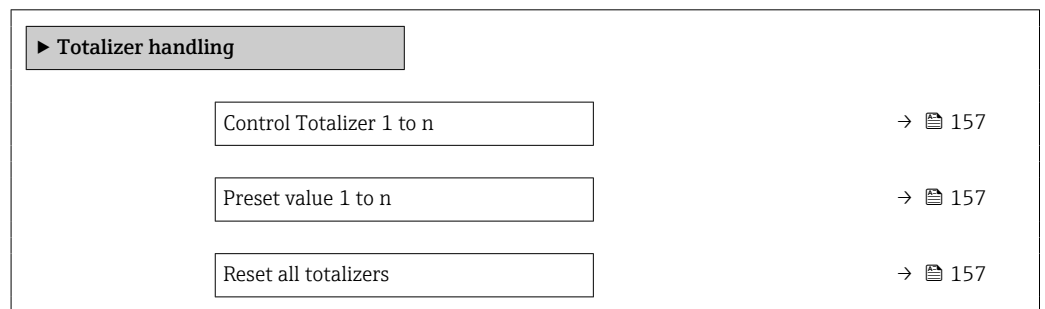

Parameter overview with brief description

Parameter	Description	Selection / User entry
Control Totalizer 1 to n	Control totalizer value.	<ul style="list-style-type: none"> <li>■ Totalize</li> <li>■ Reset + hold</li> <li>■ Preset + hold</li> </ul>
Preset value 1 to n	Specify start value for totalizer.	Signed floating-point number
Reset all totalizers	Reset all totalizers to 0 and start.	<ul style="list-style-type: none"> <li>■ Cancel</li> <li>■ Reset + totalize</li> </ul>

### 11.7 Showing data logging

The **Extended HistoROM** application package must be enabled in the device (order option) for the **Data logging** submenu to appear. This contains all the parameters for the measured value history.

- Data logging is also available via:
  - Plant Asset Management Tool FieldCare → 85.
  - Web browser

**Function range**

- A total of 1000 measured values can be stored
- 4 logging channels
- Adjustable logging interval for data logging
- Display of the measured value trend for each logging channel in the form of a chart

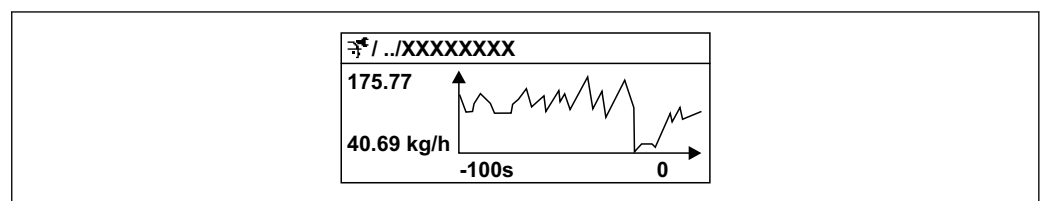

34 Chart of a measured value trend

A0016357

- x-axis: depending on the number of channels selected displays 250 to 1000 measured values of a process variable.
- y-axis: displays the approximate measured value span and constantly adapts this to the ongoing measurement.

 If the length of the logging interval or the assignment of the process variables to the channels is changed, the content of the data logging is deleted.

### Navigation

"Diagnostics" menu → Data logging

► Data logging	
Assign channel 1	→ 159
Assign channel 2	→ 159
Assign channel 3	→ 159
Assign channel 4	→ 159
Logging interval	→ 159
Clear logging data	→ 159
Data logging	→ 159
Logging delay	→ 160
Data logging control	→ 160
Data logging status	→ 160
Entire logging duration	→ 160
► Display channel 1	
► Display channel 2	
► Display channel 3	
► Display channel 4	

## Parameter overview with brief description

Parameter	Prerequisite	Description	Selection / User entry / User interface
Assign channel 1	The <b>Extended HistoROM</b> application package is available.	Assign process variable to logging channel.	<ul style="list-style-type: none"> <li>■ Off</li> <li>■ Mass flow</li> <li>■ Volume flow</li> <li>■ Corrected volume flow</li> <li>■ Target mass flow *</li> <li>■ Carrier mass flow *</li> <li>■ Target volume flow *</li> <li>■ Carrier volume flow *</li> <li>■ Target corrected volume flow *</li> <li>■ Carrier corrected volume flow *</li> <li>■ Density</li> <li>■ Reference density</li> <li>■ Concentration *</li> <li>■ Temperature</li> <li>■ Carrier pipe temperature *</li> <li>■ Electronic temperature</li> <li>■ Oscillation frequency 0</li> <li>■ Oscillation amplitude *</li> <li>■ Frequency fluctuation 0</li> <li>■ Oscillation damping 0</li> <li>■ Oscillation damping fluctuation 0</li> <li>■ Signal asymmetry</li> <li>■ Exciter current 0</li> <li>■ HBSI *</li> <li>■ Current output 1</li> <li>■ Current output 2 *</li> <li>■ Current output 3 *</li> <li>■ Current output 4 *</li> <li>■ Pressure</li> </ul>
Assign channel 2	The <b>Extended HistoROM</b> application package is available.  The software options currently enabled are displayed in the <b>Software option overview</b> parameter.	Assign process variable to logging channel.	Picklist, see <b>Assign channel 1</b> parameter (→  159)
Assign channel 3	The <b>Extended HistoROM</b> application package is available.  The software options currently enabled are displayed in the <b>Software option overview</b> parameter.	Assign process variable to logging channel.	Picklist, see <b>Assign channel 1</b> parameter (→  159)
Assign channel 4	The <b>Extended HistoROM</b> application package is available.  The software options currently enabled are displayed in the <b>Software option overview</b> parameter.	Assign process variable to logging channel.	Picklist, see <b>Assign channel 1</b> parameter (→  159)
Logging interval	The <b>Extended HistoROM</b> application package is available.	Define the logging interval for data logging. This value defines the time interval between the individual data points in the memory.	0.1 to 3 600.0 s
Clear logging data	The <b>Extended HistoROM</b> application package is available.	Clear the entire logging data.	<ul style="list-style-type: none"> <li>■ Cancel</li> <li>■ Clear data</li> </ul>
Data logging	–	Select the data logging method.	<ul style="list-style-type: none"> <li>■ Overwriting</li> <li>■ Not overwriting</li> </ul>

Parameter	Prerequisite	Description	Selection / User entry / User interface
Logging delay	In the <b>Data logging</b> parameter, the <b>Not overwriting</b> option is selected.	Enter the time delay for measured value logging.	0 to 999 h
Data logging control	In the <b>Data logging</b> parameter, the <b>Not overwriting</b> option is selected.	Start and stop measured value logging.	<ul style="list-style-type: none"> <li>▪ None</li> <li>▪ Delete + start</li> <li>▪ Stop</li> </ul>
Data logging status	In the <b>Data logging</b> parameter, the <b>Not overwriting</b> option is selected.	Displays the measured value logging status.	<ul style="list-style-type: none"> <li>▪ Done</li> <li>▪ Delay active</li> <li>▪ Active</li> <li>▪ Stopped</li> </ul>
Entire logging duration	In the <b>Data logging</b> parameter, the <b>Not overwriting</b> option is selected.	Displays the total logging duration.	Positive floating-point number

\* Visibility depends on order options or device settings

## 12 Diagnostics and troubleshooting

### 12.1 General troubleshooting

For local display

Error	Possible causes	Solution
Local display dark and no output signals	Supply voltage does not match the value indicated on the nameplate.	Apply the correct supply voltage .
Local display dark and no output signals	The polarity of the supply voltage is wrong.	Correct the polarity.
Local display dark and no output signals	No contact between connecting cables and terminals.	Check the connection of the cables and correct if necessary.
Local display dark and no output signals	Terminals are not plugged into the I/O electronics module correctly. Terminals are not plugged into the main electronics module correctly.	Check terminals.
Local display dark and no output signals	I/O electronics module is defective. Main electronics module is defective.	Order spare part → ☰ 234.
Local display dark and no output signals	The connector between the main electronics module and display module is not plugged in correctly.	Check the connection and correct if necessary.
Local display dark and no output signals	The connecting cable is not plugged in correctly.	1. Check the connection of the electrode cable and correct if necessary. 2. Check the connection of the coil current cable and correct if necessary.
Local display is dark, but signal output is within the valid range	Display is set too bright or too dark.	<ul style="list-style-type: none"> <li>▪ Set the display brighter by simultaneously pressing ☐ + ☒.</li> <li>▪ Set the display darker by simultaneously pressing ☐ + ☓.</li> </ul>
Local display is dark, but signal output is within the valid range	The cable of the display module is not plugged in correctly.	Insert the plug correctly into the main electronics module and display module.
Local display is dark, but signal output is within the valid range	Display module is defective.	Order spare part → ☰ 234.
Backlighting of local display is red	Diagnostic event with "Alarm" diagnostic behavior has occurred.	Take remedial measures → ☰ 175
Text on local display appears in a foreign language and cannot be understood.	Incorrect operating language is configured.	<ol style="list-style-type: none"> <li>1. Press ☐ + ☐ for 2 s ("home position").</li> <li>2. Press ☒.</li> <li>3. Set the desired language in the <b>Display language</b> parameter (→ ☰ 138).</li> </ol>
Message on local display: "Communication Error" "Check Electronics"	Communication between the display module and the electronics is interrupted.	<ul style="list-style-type: none"> <li>▪ Check the cable and the connector between the main electronics module and display module.</li> <li>▪ Order spare part → ☰ 234.</li> </ul>

*For output signals*

Error	Possible causes	Solution
Signal output outside the valid range	Main electronics module is defective.	Order spare part → ☰ 234.
Device shows correct value on local display, but signal output is incorrect, though in the valid range.	Configuration error	Check and correct the parameter configuration.
Device measures incorrectly.	Configuration error or device is operated outside the application.	1. Check and correct parameter configuration. 2. Observe limit values specified in the "Technical Data".

*For access*

Error	Possible causes	Solution
No write access to parameters	Hardware write protection enabled	Set the write protection switch on main electronics module to the <b>OFF</b> position → ☰ 147.
No write access to parameters	Current user role has limited access authorization	1. Check user role → ☰ 74. 2. Enter correct customer-specific access code → ☰ 74.
No connection via PROFIBUS DP	PROFIBUS DP bus cable connected incorrectly	Check terminal assignment → ☰ 40.
No connection via PROFIBUS DP	PROFIBUS DP cable incorrectly terminated	Check terminating resistor .
Not connecting to Web server	Web server disabled	Using the "FieldCare" or "DeviceCare" operating tool, check whether the Web server of the measuring device is enabled, and enable it if necessary → ☰ 81.
	Incorrect setting for the Ethernet interface of the computer	1. Check the properties of the Internet protocol (TCP/IP) → ☰ 77 → ☰ 77. 2. Check the network settings with the IT manager.
Not connecting to Web server	Incorrect IP address	Check the IP address: 192.168.1.212 → ☰ 77 → ☰ 77
Not connecting to Web server	Incorrect WLAN access data	<ul style="list-style-type: none"> <li>▪ Check WLAN network status.</li> <li>▪ Log on to the device again using WLAN access data.</li> <li>▪ Verify that WLAN is enabled on the measuring device and operating device → ☰ 77.</li> </ul>
	WLAN communication disabled	–
Not connecting to Web server, FieldCare or DeviceCare	No WLAN network available	<ul style="list-style-type: none"> <li>▪ Check if WLAN reception is present: LED on display module is lit blue</li> <li>▪ Check if WLAN connection is enabled: LED on display module flashes blue</li> <li>▪ Switch on instrument function.</li> </ul>
Network connection not present or unstable	WLAN network is weak.	<ul style="list-style-type: none"> <li>▪ Operating device is outside of reception range: Check network status on operating device.</li> <li>▪ To improve network performance, use an external WLAN antenna.</li> </ul>

Error	Possible causes	Solution
	Parallel WLAN and Ethernet communication	<ul style="list-style-type: none"> <li>▪ Check network settings.</li> <li>▪ Temporarily enable only the WLAN as an interface.</li> </ul>
Web browser frozen and operation no longer possible	Data transfer active	Wait until data transfer or current action is finished.
	Connection lost	<ol style="list-style-type: none"> <li>1. Check cable connection and power supply.</li> <li>2. Refresh the Web browser and restart if necessary.</li> </ol>
Content of Web browser incomplete or difficult to read	Not using optimum version of Web server.	<ol style="list-style-type: none"> <li>1. Use the correct Web browser version → 76.</li> <li>2. Clear the Web browser cache and restart the Web browser.</li> </ol>
	Unsuitable view settings.	Change the font size/display ratio of the Web browser.
No or incomplete display of contents in the Web browser	<ul style="list-style-type: none"> <li>▪ JavaScript not enabled</li> <li>▪ JavaScript cannot be enabled</li> </ul>	<ol style="list-style-type: none"> <li>1. Enable JavaScript.</li> <li>2. Enter <code>http://XXX.XXX.X.XXX/basic.html</code> as the IP address.</li> </ol>
Operation with FieldCare or DeviceCare via CDI-RJ45 service interface (port 8000)	Firewall of computer or network is preventing communication	Depending on the settings of the firewall used on the computer or in the network, the firewall must be adapted or disabled to allow FieldCare/DeviceCare access.
Flashing of firmware with FieldCare or DeviceCare via CDI-RJ45 service interface (via port 8000 or TFTP ports)	Firewall of computer or network is preventing communication	Depending on the settings of the firewall used on the computer or in the network, the firewall must be adapted or disabled to allow FieldCare/DeviceCare access.

## 12.2 Diagnostic information via light emitting diodes

### 12.2.1 Transmitter

#### Proline 500 – digital

Different LEDs in the transmitter provide information on the device status.

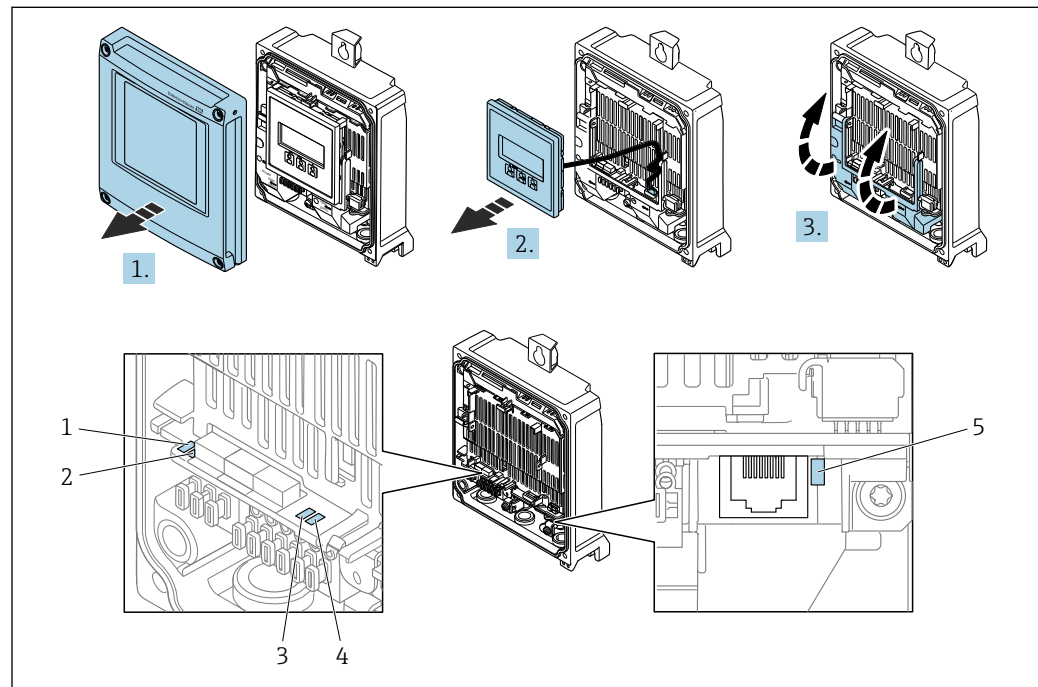

A0029689

- 1 Supply voltage
- 2 Device status
- 3 Not used
- 4 Communication
- 5 Service interface (CDI) active, Ethernet Link/Activity

1. Open the housing cover.
2. Remove the display module.
3. Fold open the terminal cover.

LED	Color	Meaning
1 Supply voltage	Off	Supply voltage is off or too low.
	Green	Supply voltage is ok.
2 Device status (normal operation)	Off	Firmware error
	Green	Device status is ok.
	Flashing green	Device is not configured.
	Flashing red	A diagnostic event with "Warning" diagnostic behavior has occurred.
	Red	A diagnostic event with "Alarm" diagnostic behavior has occurred.
	Flashing red/green	The device restarts.
2 Device status (during start-up)	Flashes red slowly	If > 30 seconds: problem with the boot loader.
	Flashes red quickly	If > 30 seconds: compatibility problem when reading the firmware.
3 Not used	-	-



LED	Color	Meaning
4 Communication	Off	Device does not receive any Profibus data.
	White	Device receives Profibus data.
5 Service interface (CDI), Ethernet Link/Activity	Off	Not connected or no connection established.
	Yellow	Connected and connection established.
	Flashing yellow	Service interface active.

**Proline 500**

Different LEDs in the transmitter provide information on the device status.

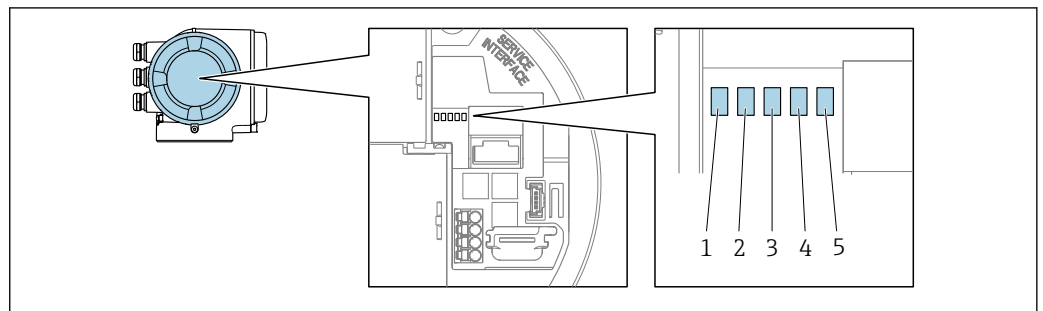

A0029629

- 1 Supply voltage
- 2 Device status
- 3 Not used
- 4 Communication
- 5 Service interface (CDI) active, Ethernet Link/Activity

LED	Color	Meaning
1 Supply voltage	Off	Supply voltage is off or too low.
	Green	Supply voltage is ok.
2 Device status (normal operation)	Off	Firmware error
	Green	Device status is ok.
	Flashing green	Device is not configured.
	Red	A diagnostic event with "Alarm" diagnostic behavior has occurred.
	Flashing red	A diagnostic event with "Warning" diagnostic behavior has occurred.
	Flashing red/green	The device restarts.
2 Device status (during start-up)	Flashes red slowly	If > 30 seconds: problem with the boot loader.
	Flashes red quickly	If > 30 seconds: compatibility problem when reading the firmware.
3 Not used	-	-
4 Communication	Off	Device does not receive any Profibus data.
	White	Device receives Profibus data.
5 Service interface (CDI), Ethernet Link/Activity	Off	Not connected or no connection established.
	Yellow	Connected and connection established.
	Flashing yellow	Service interface active.

## 12.2.2 Sensor connection housing

### Proline 500 – digital

Various light emitting diodes (LED) on the ISEM electronics (Intelligent Sensor Electronic Module) in the sensor connection housing provide information on the device status.

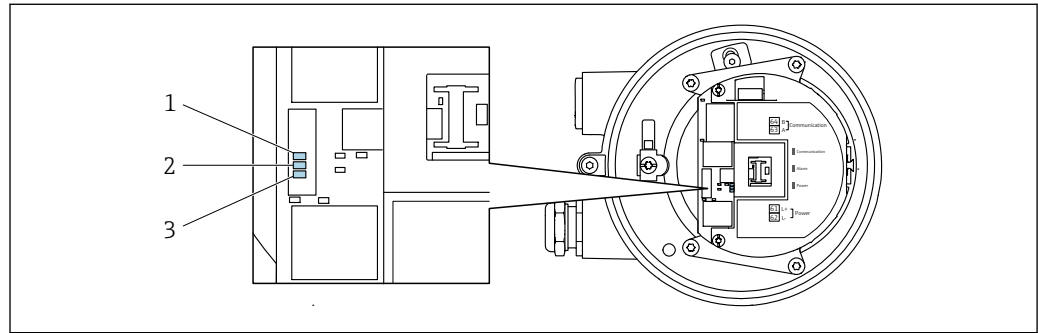

A0029699

- 1 *Communication*
- 2 *Device status*
- 3 *Supply voltage*

LED	Color	Meaning
1 Communication	White	Communication active.
2 Device status (normal operation)	Red	Problem
	Flashing red	Warning
2 Device status (during start-up)	Flashes red slowly	If > 30 seconds: problem with the boot loader.
	Flashes red quickly	If > 30 seconds: compatibility problem when reading the firmware.
3 Supply voltage	Green	Supply voltage is ok.
	Off	Supply voltage is off or too low.

## 12.3 Diagnostic information on local display

### 12.3.1 Diagnostic message

Faults detected by the self-monitoring system of the measuring device are displayed as a diagnostic message in alternation with the operational display.

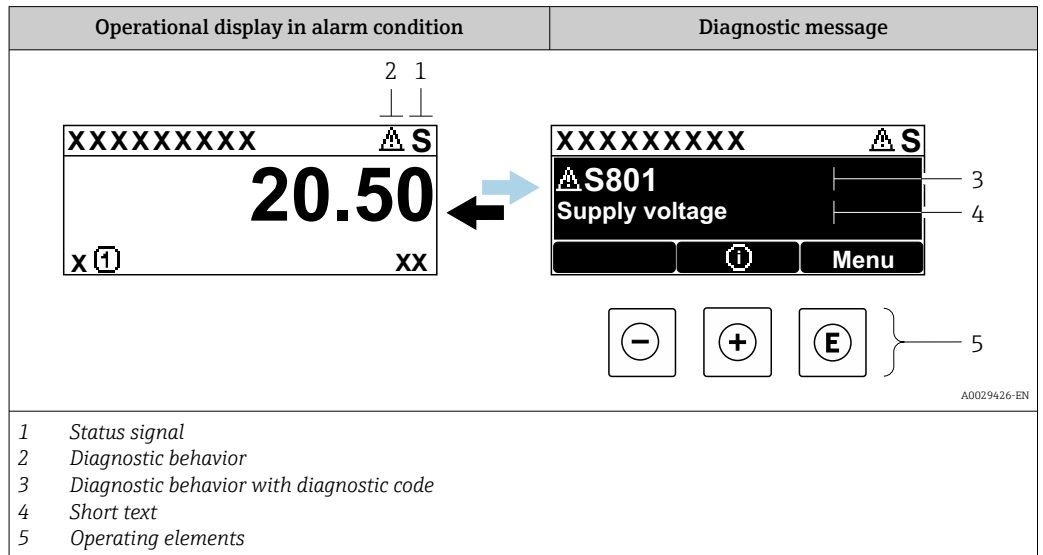

If two or more diagnostic events are pending simultaneously, only the message of the diagnostic event with the highest priority is shown.

- i** Other diagnostic events that have occurred can be displayed in the **Diagnostics** menu:
  - Via parameter → 226
  - Via submenus → 226



#### Status signals

The status signals provide information on the state and reliability of the device by categorizing the cause of the diagnostic information (diagnostic event).

- i** The status signals are categorized according to VDI/VDE 2650 and NAMUR Recommendation NE 107: F = Failure, C = Function Check, S = Out of Specification, M = Maintenance Required

Symbol	Meaning
<b>F</b>	<b>Failure</b> A device error has occurred. The measured value is no longer valid.
<b>C</b>	<b>Function check</b> The device is in service mode (e.g. during a simulation).
<b>S</b>	<b>Out of specification</b> The device is operated: Outside its technical specification limits (e.g. outside the process temperature range)
<b>M</b>	<b>Maintenance required</b> Maintenance is required. The measured value remains valid.

### Diagnostic behavior



Symbol	Meaning
	<b>Alarm</b> <ul style="list-style-type: none"> <li>▪ Measurement is interrupted.</li> <li>▪ Signal outputs and totalizers assume the defined alarm condition.</li> <li>▪ A diagnostic message is generated.</li> </ul>
	<b>Warning</b> Measurement is resumed. The signal outputs and totalizers are not affected. A diagnostic message is generated.

### Diagnostic information

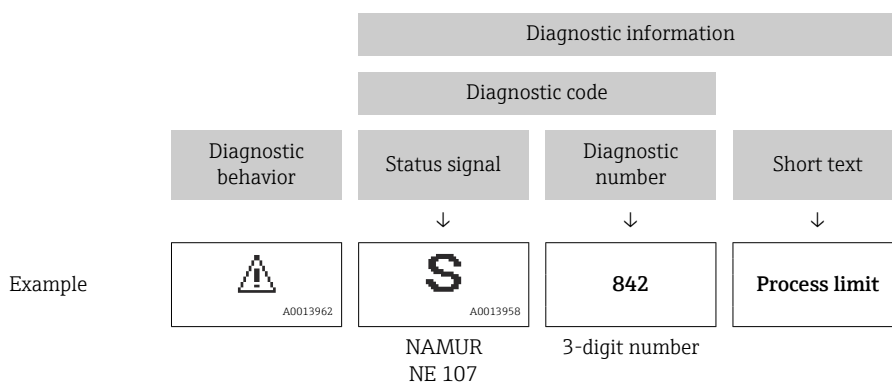
The fault can be identified using the diagnostic information. The short text helps you by providing information about the fault. In addition, the corresponding symbol for the diagnostic behavior is displayed in front of the diagnostic information on the local display.



### Operating elements

Key	Meaning
	<b>Plus key</b> <i>In a menu, submenu</i> Opens the message about remedy information.
	<b>Enter key</b> <i>In a menu, submenu</i> Opens the operating menu.

### 12.3.2 Calling up remedial measures

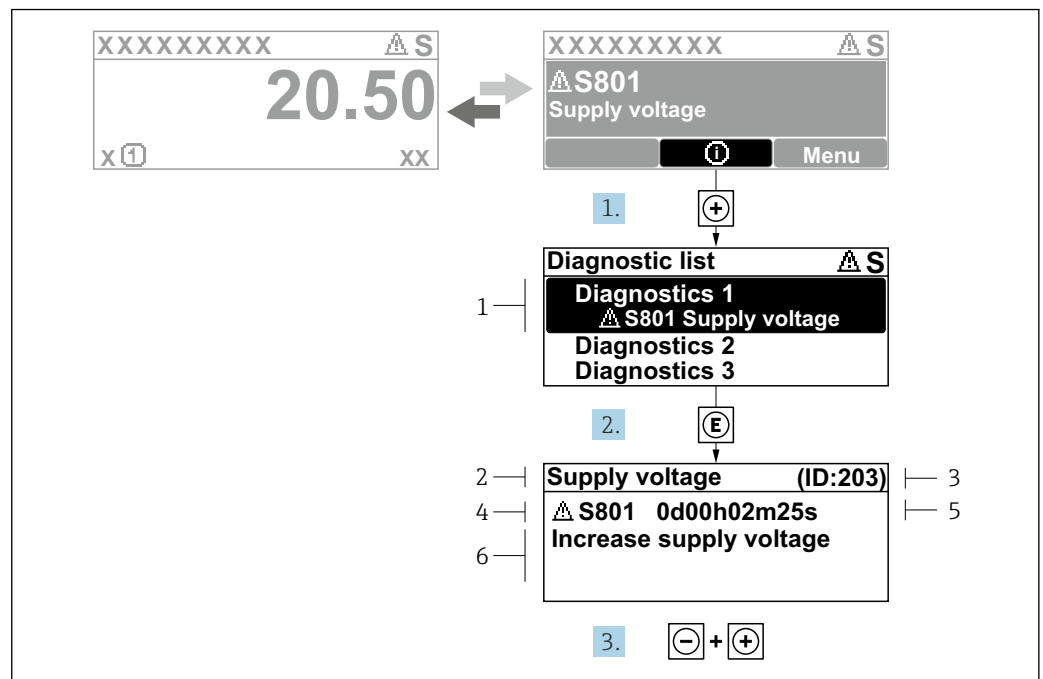

A0029431-EN

35 Message about remedial measures

- 1 Diagnostic information
- 2 Short text
- 3 Service ID
- 4 Diagnostic behavior with diagnostic code
- 5 Operation time of occurrence
- 6 Remedial measures

1. The user is in the diagnostic message.  
Press  $\oplus$  ( $\text{\textcircled{1}}$  symbol).  
↳ The **Diagnostic list** submenu opens.
2. Select the desired diagnostic event with  $\oplus$  or  $\ominus$  and press  $\text{\textcircled{E}}$ .  
↳ The message about the remedial measures opens.
3. Press  $\ominus + \oplus$  simultaneously.  
↳ The message about the remedial measures closes.

The user is in the **Diagnostics** menu at an entry for a diagnostics event, e.g. in the **Diagnostic list** submenu or **Previous diagnostics** parameter.

1. Press  $\text{\textcircled{E}}$ .  
↳ The message for the remedial measures for the selected diagnostic event opens.
2. Press  $\ominus + \oplus$  simultaneously.  
↳ The message for the remedial measures closes.



## 12.4 Diagnostic information in the Web browser

### 12.4.1 Diagnostic options

Any faults detected by the measuring device are displayed in the Web browser on the home page once the user has logged on.





- 1 Status area with status signal
- 2 Diagnostic information
- 3 Remedy information with Service ID

 In addition, diagnostic events which have occurred can be shown in the **Diagnostics** menu:

- Via parameter →  226
- Via submenu →  226

### Status signals

The status signals provide information on the state and reliability of the device by categorizing the cause of the diagnostic information (diagnostic event).

Symbol	Meaning
	<b>Failure</b> A device error has occurred. The measured value is no longer valid.
	<b>Function check</b> The device is in service mode (e.g. during a simulation).
	<b>Out of specification</b> The device is operated: Outside its technical specification limits (e.g. outside the process temperature range)
	<b>Maintenance required</b> Maintenance is required. The measured value is still valid.

 The status signals are categorized in accordance with VDI/VDE 2650 and NAMUR Recommendation NE 107.

### 12.4.2 Calling up remedy information

Remedy information is provided for every diagnostic event to ensure that problems can be rectified quickly. These measures are displayed in red along with the diagnostic event and the related diagnostic information.

## 12.5 Diagnostic information in FieldCare or DeviceCare

### 12.5.1 Diagnostic options

Any faults detected by the measuring device are displayed on the home page of the operating tool once the connection has been established.

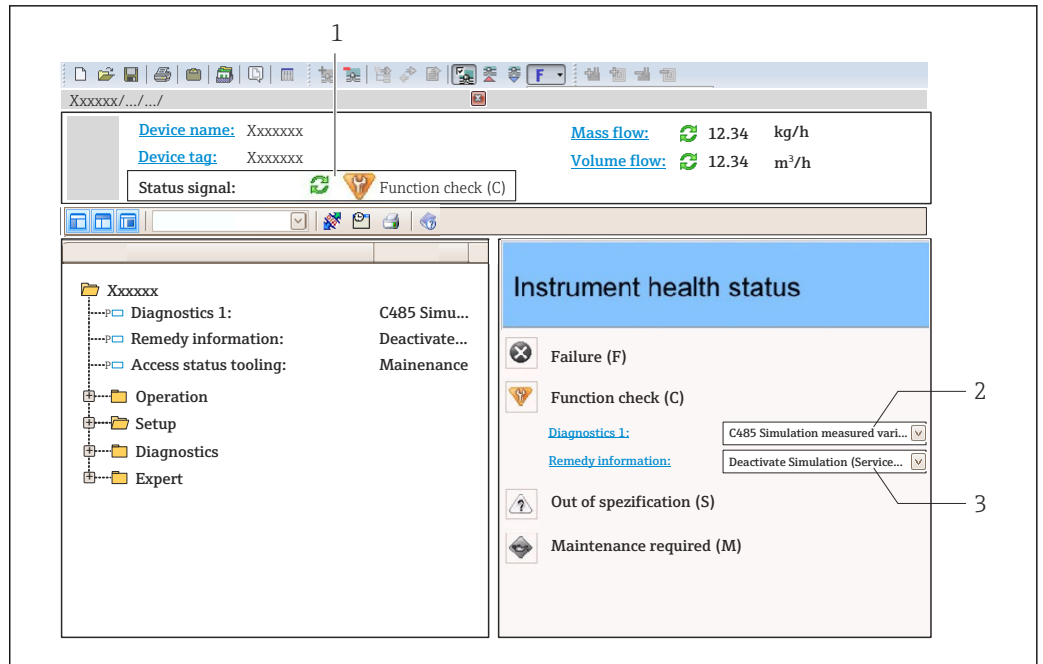

- 1 Status area with status signal → 167
- 2 Diagnostic information → 168
- 3 Remedy information with Service ID

**i** In addition, diagnostic events which have occurred can be shown in the **Diagnostics** menu:

- Via parameter → 226
- Via submenu → 226

### Diagnostic information

The fault can be identified using the diagnostic information. The short text helps you by providing information about the fault. In addition, the corresponding symbol for the diagnostic behavior is displayed in front of the diagnostic information on the local display.

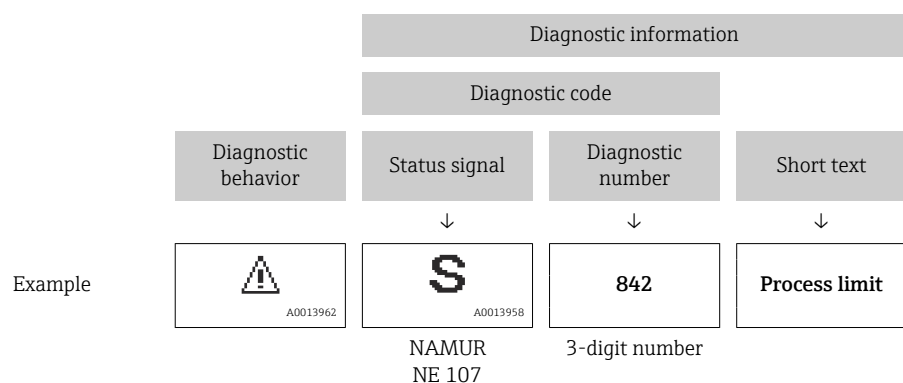

### 12.5.2 Calling up remedy information

Remedy information is provided for every diagnostic event to ensure that problems can be rectified quickly:

- On the home page  
Remedy information is displayed in a separate field below the diagnostics information.
- In the **Diagnostics** menu  
Remedy information can be called up in the working area of the user interface.

The user is in the **Diagnostics** menu.

1. Call up the desired parameter.
2. On the right in the working area, mouse over the parameter.
  - ↳ A tool tip with remedy information for the diagnostic event appears.

## 12.6 Adapting the diagnostic information

### 12.6.1 Adapting the diagnostic behavior

Each item of diagnostic information is assigned a specific diagnostic behavior at the factory. The user can change this assignment for specific diagnostic information in the **Diagnostic behavior** submenu.

Expert → System → Diagnostic handling → Diagnostic behavior

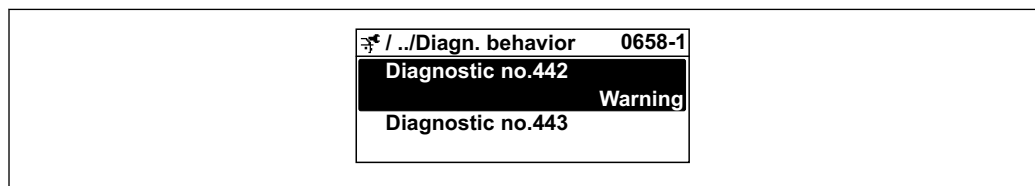

A0019179-EN

#### Available diagnostic behaviors

The following diagnostic behaviors can be assigned:

Diagnostic behavior	Description
Alarm	The device stops measurement. The totalizers assume the defined alarm condition. A diagnostic message is generated.
Warning	The device continues to measure. The measured value output via PROFIBUS and the totalizers are not affected. A diagnostic message is generated.
Logbook entry only	The device continues to measure. The diagnostic message is displayed only in the <b>Event logbook</b> submenu ( <b>Event list</b> submenu) and not in alternation with the operational display.
Off	The diagnostic event is ignored, and no diagnostic message is generated or entered.

#### Displaying the measured value status

If the Analog Input, Digital Input and Totalizer function blocks are configured for cyclic data transmission, the device status is coded as per PROFIBUS PA Profile 3.02 Specification and transmitted along with the measured value to the PROFIBUS Master (Class 1) via the coding byte (byte 5). The coding byte is split into three segments: Quality, Quality Substatus and Limits.



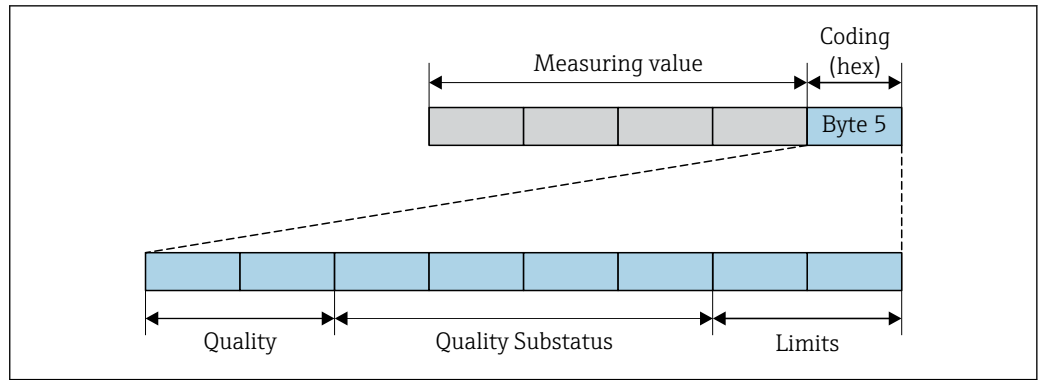

A0032228-EN

36 Structure of the coding byte

The content of the coding byte depends on the configured failsafe mode in the particular function block. Depending on which failsafe mode has been configured, status information in accordance with PROFIBUS PA Profile Specification 3.02 is transmitted to the PROFIBUS Master (Class 1) via the coding byte .

**Determining the measured value status and device status via the diagnostic behavior**

When the diagnostic behavior is assigned, this also changes the measured value status and device status for the diagnostic information. The measured value status and device status depend on the choice of diagnostic behavior and on the group in which the diagnostic information is located.

The diagnostic information is grouped as follows:

- Diagnostic information pertaining to the sensor: diagnostic number 000 to 199  
→ 173
- Diagnostic information pertaining to the electronics: diagnostic number 200 to 399  
→ 174
- Diagnostic information pertaining to the configuration: diagnostic number 400 to 599  
→ 174
- Diagnostic information pertaining to the process: diagnostic number 800 to 999  
→ 174

Depending on the group in which the diagnostic information is located, the following measured value status and device status are firmly assigned to the particular diagnostic behavior:

*Diagnostic information pertaining to the sensor: diagnostic number 000 to 199*

Diagnostic behavior (configurable)	Measured value status (fixed assignment)				Device diagnosis (fixed assignment)
	Quality	Quality Substatus	Coding (hex)	Category (NE107)	
Alarm	BAD	Maintenance alarm	0x24 to 0x27	F (Failure)	Maintenance alarm
Warning	GOOD	Maintenance demanded	0xA8 to 0xAB	M (Maintenance)	Maintenance demanded
Logbook entry only	GOOD	ok	0x80 to 0x8E	-	-
Off					

*Diagnostic information pertaining to the electronics: diagnostic number 200 to 399*

*Diagnostic number 200 to 301, 303 to 399*

Diagnostic behavior (configurable)	Measured value status (fixed assignment)				Device diagnosis (fixed assignment)
	Quality	Quality Substatus	Coding (hex)	Category (NE107)	
Alarm	BAD	Maintenance alarm	0x24 to 0x27	F (Failure)	Maintenance alarm
Warning					
Logbook entry only	GOOD	ok	0x80 to 0x8E	-	-
Off					

*Diagnostic information 302*

Diagnostic behavior (configurable)	Measured value status (fixed assignment)				Device diagnosis (fixed assignment)
	Quality	Quality Substatus	Coding (hex)	Category (NE107)	
Alarm	BAD	Function check, local override	0x3C to 0x3F	C	Function check
Warning	GOOD	Function check	0xBC to 0xBF	-	-

Diagnostic information 302 (device verification active) is output during internal or external Heartbeat verification.

- Signal status: Function check
- Choice of diagnostic behavior: alarm or warning (factory setting)

When Heartbeat verification starts, data logging is interrupted, the last valid measured value is output and the totalizers are stopped.



*Diagnostic information pertaining to the configuration: diagnostic number 400 to 599*

Diagnostic behavior (configurable)	Measured value status (fixed assignment)				Device diagnosis (fixed assignment)
	Quality	Quality Substatus	Coding (hex)	Category (NE107)	
Alarm	BAD	Function check	0x3C to 0x3F	C (Check)	Function check
Logbook entry only	GOOD	Function check	0xBC to 0xBF	-	Function check
Off					
Logbook entry only	GOOD	ok	0x80 to 0x8E	-	-
Off					

*Diagnostic information pertaining to the process: diagnostic number 800 to 999*

Diagnostic behavior (configurable)	Measured value status (fixed assignment)				Device diagnosis (fixed assignment)
	Quality	Quality Substatus	Coding (hex)	Category (NE107)	
Alarm	BAD	Process related	0x28 to 0x2B	F (Failure)	Invalid process condition
Warning	UNCERTAIN	Process related	0x78 to 0x7B	S (Out of specification)	Invalid process condition
Logbook entry only	GOOD	ok	0x80 to 0x8E	-	-
Off					

## 12.7 Overview of diagnostic information

-  The amount of diagnostic information and the number of measured variables affected increase if the measuring device has one or more application packages.
  - All of the measured variables affected in the entire Promass instrument family are always listed under "Measured variables affected". The measured variables available for the device in question depend on the device version. When assigning the measured variables to the device functions, for example to the individual outputs, all of the measured variables available for the device version in question are available for selection.
-  In the case of some items of diagnostic information, the diagnostic behavior can be changed. Change the diagnostic information →  172

### 12.7.1 Diagnostic of sensor

Diagnostic information		Remedy instructions	
No.	Short text		
022	Temperature sensor defective	1. Check or replace sensor electronic module (ISEM) 2. If available: Check connection cable between sensor and transmitter 3. Replace sensor	
	<b>Measured variable status</b>		
	Quality		Bad
	Quality substatus		Maintenance alarm
	Coding (hex)		0x24 to 0x27
	Status signal		F
	Diagnostic behavior		Alarm
<b>Influenced measured variables</b>			
<ul style="list-style-type: none"> <li>▪ Oscillation amplitude 1</li> <li>▪ Oscillation amplitude 2</li> <li>▪ Signal asymmetry</li> <li>▪ Carrier mass flow</li> <li>▪ Carrier pipe temperature</li> <li>▪ Target corrected volume flow</li> <li>▪ Carrier corrected volume flow</li> <li>▪ Concentration</li> <li>▪ Oscillation damping 1</li> <li>▪ Oscillation damping 2</li> <li>▪ Density</li> <li>▪ Oil density</li> <li>▪ Water density</li> <li>▪ Dynamic viscosity</li> <li>▪ Sensor electronic temperature (ISEM)</li> <li>▪ <b>Empty pipe detection</b> option</li> <li>▪ GSV flow</li> <li>▪ GSV flow alternative</li> </ul>		<ul style="list-style-type: none"> <li>▪ Kinematic viscosity</li> <li>▪ <b>Low flow cut off</b> option</li> <li>▪ Mass flow</li> <li>▪ Oil mass flow</li> <li>▪ Water mass flow</li> <li>▪ HBSI</li> <li>▪ NSV flow</li> <li>▪ NSV flow alternative</li> <li>▪ External pressure</li> <li>▪ Exciter current 1</li> <li>▪ Exciter current 2</li> <li>▪ Oscillation frequency 1</li> <li>▪ Oscillation frequency 2</li> <li>▪ S&amp;W volume flow</li> <li>▪ Reference density</li> <li>▪ Reference density alternative</li> <li>▪ Corrected volume flow</li> <li>▪ Oil corrected volume flow</li> </ul>	
		<ul style="list-style-type: none"> <li>▪ Water corrected volume flow</li> <li>▪ Oscillation damping fluctuation 1</li> <li>▪ Oscillation damping fluctuation 2</li> <li>▪ Frequency fluctuation 1</li> <li>▪ Frequency fluctuation 2</li> <li>▪ Target mass flow</li> <li>▪ Carrier volume flow</li> <li>▪ Target volume flow</li> <li>▪ Temp. compensated dynamic viscosity</li> <li>▪ Temp. compensated kinematic viscosity</li> <li>▪ Temperature</li> <li>▪ Status</li> <li>▪ Volume flow</li> <li>▪ Oil volume flow</li> <li>▪ Water volume flow</li> <li>▪ Water cut</li> </ul>	

Diagnostic information		Remedy instructions	
No.	Short text		
046	Sensor limit exceeded	1. Inspect sensor 2. Check process condition	
	<b>Measured variable status [from the factory] <sup>1)</sup></b>		
	Quality		Good
	Quality substatus		Maintenance demanded
	Coding (hex)		0xA8 to 0xAB
	Status signal		S
	Diagnostic behavior		Warning
<b>Influenced measured variables</b>			
<ul style="list-style-type: none"> <li>▪ Oscillation amplitude 1</li> <li>▪ Oscillation amplitude 2</li> <li>▪ Signal asymmetry</li> <li>▪ Carrier mass flow</li> <li>▪ Carrier pipe temperature</li> <li>▪ Target corrected volume flow</li> <li>▪ Carrier corrected volume flow</li> <li>▪ Concentration</li> <li>▪ Oscillation damping 1</li> <li>▪ Oscillation damping 2</li> <li>▪ Density</li> <li>▪ Oil density</li> <li>▪ Water density</li> <li>▪ Dynamic viscosity</li> <li>▪ Sensor electronic temperature (ISEM)</li> <li>▪ <b>Empty pipe detection</b> option</li> <li>▪ GSV flow</li> <li>▪ GSV flow alternative</li> <li>▪ Kinematic viscosity</li> <li>▪ <b>Low flow cut off</b> option</li> <li>▪ Mass flow</li> <li>▪ Oil mass flow</li> <li>▪ Water mass flow</li> <li>▪ HBSI</li> <li>▪ NSV flow</li> <li>▪ NSV flow alternative</li> <li>▪ External pressure</li> <li>▪ Exciter current 1</li> <li>▪ Exciter current 2</li> <li>▪ Oscillation frequency 1</li> <li>▪ Oscillation frequency 2</li> <li>▪ S&amp;W volume flow</li> <li>▪ Reference density</li> <li>▪ Reference density alternative</li> <li>▪ Corrected volume flow</li> <li>▪ Oil corrected volume flow</li> <li>▪ Water corrected volume flow</li> <li>▪ Oscillation damping fluctuation 1</li> <li>▪ Oscillation damping fluctuation 2</li> <li>▪ Frequency fluctuation 1</li> <li>▪ Frequency fluctuation 2</li> <li>▪ Target mass flow</li> <li>▪ Carrier volume flow</li> <li>▪ Target volume flow</li> <li>▪ Temp. compensated dynamic viscosity</li> <li>▪ Temp. compensated kinematic viscosity</li> <li>▪ Temperature</li> <li>▪ Status</li> <li>▪ Volume flow</li> <li>▪ Oil volume flow</li> <li>▪ Water volume flow</li> <li>▪ Water cut</li> </ul>			

1) Diagnostic behavior can be changed. This causes the overall status of the measured variable to change.

Diagnostic information		Remedy instructions	
No.	Short text		
062	Sensor connection faulty	1. Check or replace sensor electronic module (ISEM) 2. If available: Check connection cable between sensor and transmitter 3. Replace sensor	
	<b>Measured variable status</b>		
	Quality		Bad
	Quality substatus		Maintenance alarm
	Coding (hex)		0x24 to 0x27
	Status signal		F
	Diagnostic behavior		Alarm
<b>Influenced measured variables</b>			
<ul style="list-style-type: none"> <li>▪ Oscillation amplitude 1</li> <li>▪ Oscillation amplitude 2</li> <li>▪ Signal asymmetry</li> <li>▪ Carrier mass flow</li> <li>▪ Carrier pipe temperature</li> <li>▪ Target corrected volume flow</li> <li>▪ Carrier corrected volume flow</li> <li>▪ Concentration</li> <li>▪ Oscillation damping 1</li> <li>▪ Oscillation damping 2</li> <li>▪ Density</li> <li>▪ Oil density</li> <li>▪ Water density</li> <li>▪ Dynamic viscosity</li> <li>▪ Sensor electronic temperature (ISEM)</li> <li>▪ <b>Empty pipe detection</b> option</li> <li>▪ GSV flow</li> <li>▪ GSV flow alternative</li> </ul>		<ul style="list-style-type: none"> <li>▪ Kinematic viscosity</li> <li>▪ <b>Low flow cut off</b> option</li> <li>▪ Mass flow</li> <li>▪ Oil mass flow</li> <li>▪ Water mass flow</li> <li>▪ HBSI</li> <li>▪ NSV flow</li> <li>▪ NSV flow alternative</li> <li>▪ External pressure</li> <li>▪ Exciter current 1</li> <li>▪ Exciter current 2</li> <li>▪ Oscillation frequency 1</li> <li>▪ Oscillation frequency 2</li> <li>▪ S&amp;W volume flow</li> <li>▪ Reference density</li> <li>▪ Reference density alternative</li> <li>▪ Corrected volume flow</li> <li>▪ Oil corrected volume flow</li> </ul>	
<ul style="list-style-type: none"> <li>▪ Water corrected volume flow</li> <li>▪ Oscillation damping fluctuation 1</li> <li>▪ Oscillation damping fluctuation 2</li> <li>▪ Frequency fluctuation 1</li> <li>▪ Frequency fluctuation 2</li> <li>▪ Target mass flow</li> <li>▪ Carrier volume flow</li> <li>▪ Target volume flow</li> <li>▪ Temp. compensated dynamic viscosity</li> <li>▪ Temp. compensated kinematic viscosity</li> <li>▪ Temperature</li> <li>▪ Status</li> <li>▪ Volume flow</li> <li>▪ Oil volume flow</li> <li>▪ Water volume flow</li> <li>▪ Water cut</li> </ul>			

Diagnostic information		Remedy instructions	
No.	Short text		
063	Exciter current faulty	1. Check or replace sensor electronic module (ISEM) 2. If available: Check connection cable between sensor and transmitter 3. Replace sensor	
	<b>Measured variable status</b>		
	Quality		Bad
	Quality substatus		Maintenance alarm
	Coding (hex)		0x24 to 0x27
	Status signal		S
	Diagnostic behavior		Alarm
<b>Influenced measured variables</b>			
<ul style="list-style-type: none"> <li>▪ Oscillation amplitude 1</li> <li>▪ Oscillation amplitude 2</li> <li>▪ Signal asymmetry</li> <li>▪ Carrier mass flow</li> <li>▪ Carrier pipe temperature</li> <li>▪ Target corrected volume flow</li> <li>▪ Carrier corrected volume flow</li> <li>▪ Concentration</li> <li>▪ Oscillation damping 1</li> <li>▪ Oscillation damping 2</li> <li>▪ Density</li> <li>▪ Oil density</li> <li>▪ Water density</li> <li>▪ Dynamic viscosity</li> <li>▪ Sensor electronic temperature (ISEM)</li> <li>▪ <b>Empty pipe detection</b> option</li> </ul>		<ul style="list-style-type: none"> <li>▪ GSV flow</li> <li>▪ GSV flow alternative</li> <li>▪ Kinematic viscosity</li> <li>▪ <b>Low flow cut off</b> option</li> <li>▪ Mass flow</li> <li>▪ Oil mass flow</li> <li>▪ Water mass flow</li> <li>▪ HBSI</li> <li>▪ NSV flow</li> <li>▪ NSV flow alternative</li> <li>▪ External pressure</li> <li>▪ Exciter current 1</li> <li>▪ Exciter current 2</li> <li>▪ Oscillation frequency 1</li> <li>▪ Oscillation frequency 2</li> <li>▪ S&amp;W volume flow</li> </ul>	
<ul style="list-style-type: none"> <li>▪ Reference density</li> <li>▪ Reference density alternative</li> <li>▪ Corrected volume flow</li> <li>▪ Oil corrected volume flow</li> <li>▪ Water corrected volume flow</li> <li>▪ Target mass flow</li> <li>▪ Carrier volume flow</li> <li>▪ Target volume flow</li> <li>▪ Temp. compensated dynamic viscosity</li> <li>▪ Temp. compensated kinematic viscosity</li> <li>▪ Temperature</li> <li>▪ Status</li> <li>▪ Volume flow</li> <li>▪ Oil volume flow</li> <li>▪ Water volume flow</li> <li>▪ Water cut</li> </ul>			

Diagnostic information		Remedy instructions	
No.	Short text		
082	Data storage	1. Check module connections 2. Contact service	
<b>Measured variable status</b>			
Quality	Bad		
Quality substatus	Maintenance alarm		
Coding (hex)	0x24 to 0x27		
Status signal	F		
Diagnostic behavior	Alarm		
<b>Influenced measured variables</b>			
<ul style="list-style-type: none"> <li>▪ Oscillation amplitude 1</li> <li>▪ Oscillation amplitude 2</li> <li>▪ Signal asymmetry</li> <li>▪ Carrier mass flow</li> <li>▪ Carrier pipe temperature</li> <li>▪ Target corrected volume flow</li> <li>▪ Carrier corrected volume flow</li> <li>▪ Concentration</li> <li>▪ Measured values 1</li> <li>▪ Measured values 2</li> <li>▪ Measured values 3</li> <li>▪ Oscillation damping 1</li> <li>▪ Oscillation damping 2</li> <li>▪ Density</li> <li>▪ Oil density</li> <li>▪ Water density</li> <li>▪ Dynamic viscosity</li> <li>▪ Sensor electronic temperature (ISEM)</li> <li>▪ <b>Empty pipe detection</b> option</li> </ul>		<ul style="list-style-type: none"> <li>▪ GSV flow</li> <li>▪ GSV flow alternative</li> <li>▪ Kinematic viscosity</li> <li>▪ <b>Low flow cut off</b> option</li> <li>▪ Mass flow</li> <li>▪ Oil mass flow</li> <li>▪ Water mass flow</li> <li>▪ HBSI</li> <li>▪ NSV flow</li> <li>▪ NSV flow alternative</li> <li>▪ External pressure</li> <li>▪ Exciter current 1</li> <li>▪ Exciter current 2</li> <li>▪ Oscillation frequency 1</li> <li>▪ Oscillation frequency 2</li> <li>▪ S&amp;W volume flow</li> <li>▪ Reference density</li> <li>▪ Reference density alternative</li> <li>▪ Corrected volume flow</li> </ul>	<ul style="list-style-type: none"> <li>▪ Oil corrected volume flow</li> <li>▪ Water corrected volume flow</li> <li>▪ Oscillation damping fluctuation 1</li> <li>▪ Oscillation damping fluctuation 2</li> <li>▪ Frequency fluctuation 1</li> <li>▪ Frequency fluctuation 2</li> <li>▪ Target mass flow</li> <li>▪ Carrier volume flow</li> <li>▪ Target volume flow</li> <li>▪ Temp. compensated dynamic viscosity</li> <li>▪ Temp. compensated kinematic viscosity</li> <li>▪ Temperature</li> <li>▪ Status</li> <li>▪ Volume flow</li> <li>▪ Oil volume flow</li> <li>▪ Water volume flow</li> <li>▪ Water cut</li> </ul>

Diagnostic information		Remedy instructions	
No.	Short text		
083	Memory content	1. Restart device 2. Restore HistoROM S-DAT backup ('Device reset' parameter) 3. Replace HistoROM S-DAT	
	<b>Measured variable status</b>		
	Quality		Bad
	Quality substatus		Maintenance alarm
	Coding (hex)		0x24 to 0x27
	Status signal		F
	Diagnostic behavior		Alarm
<b>Influenced measured variables</b>			
<ul style="list-style-type: none"> <li>▪ Oscillation amplitude 1</li> <li>▪ Oscillation amplitude 2</li> <li>▪ Signal asymmetry</li> <li>▪ Carrier mass flow</li> <li>▪ Carrier pipe temperature</li> <li>▪ Target corrected volume flow</li> <li>▪ Carrier corrected volume flow</li> <li>▪ Concentration</li> <li>▪ Measured values 1</li> <li>▪ Measured values 2</li> <li>▪ Measured values 3</li> <li>▪ Oscillation damping 1</li> <li>▪ Oscillation damping 2</li> <li>▪ Density</li> <li>▪ Oil density</li> <li>▪ Water density</li> <li>▪ Dynamic viscosity</li> <li>▪ Sensor electronic temperature (ISEM)</li> <li>▪ <b>Empty pipe detection</b> option</li> <li>▪ GSV flow</li> <li>▪ GSV flow alternative</li> <li>▪ Kinematic viscosity</li> <li>▪ <b>Low flow cut off</b> option</li> <li>▪ Mass flow</li> <li>▪ Oil mass flow</li> <li>▪ Water mass flow</li> <li>▪ HBSI</li> <li>▪ NSV flow</li> <li>▪ NSV flow alternative</li> <li>▪ External pressure</li> <li>▪ Exciter current 1</li> <li>▪ Exciter current 2</li> <li>▪ Oscillation frequency 1</li> <li>▪ Oscillation frequency 2</li> <li>▪ S&amp;W volume flow</li> <li>▪ Reference density</li> <li>▪ Reference density alternative</li> <li>▪ Corrected volume flow</li> <li>▪ Oil corrected volume flow</li> <li>▪ Water corrected volume flow</li> <li>▪ Oscillation damping fluctuation 1</li> <li>▪ Oscillation damping fluctuation 2</li> <li>▪ Frequency fluctuation 1</li> <li>▪ Frequency fluctuation 2</li> <li>▪ Target mass flow</li> <li>▪ Carrier volume flow</li> <li>▪ Target volume flow</li> <li>▪ Temp. compensated dynamic viscosity</li> <li>▪ Temp. compensated kinematic viscosity</li> <li>▪ Temperature</li> <li>▪ Status</li> <li>▪ Volume flow</li> <li>▪ Oil volume flow</li> <li>▪ Water volume flow</li> <li>▪ Water cut</li> </ul>			

Diagnostic information		Remedy instructions	
No.	Short text		
140	Sensor signal asymmetrical	1. Check or replace sensor electronic module (ISEM) 2. If available: Check connection cable between sensor and transmitter 3. Replace sensor	
	<b>Measured variable status [from the factory] <sup>1)</sup></b>		
	Quality		Bad
	Quality substatus		Maintenance alarm
	Coding (hex)		0x24 to 0x27
	Status signal		S
	Diagnostic behavior		Alarm
<b>Influenced measured variables</b>			
<ul style="list-style-type: none"> <li>▪ Oscillation amplitude 1</li> <li>▪ Oscillation amplitude 2</li> <li>▪ Signal asymmetry</li> <li>▪ Carrier mass flow</li> <li>▪ Carrier pipe temperature</li> <li>▪ Target corrected volume flow</li> <li>▪ Carrier corrected volume flow</li> <li>▪ Concentration</li> <li>▪ Measured values 1</li> <li>▪ Measured values 2</li> <li>▪ Measured values 3</li> <li>▪ Oscillation damping 1</li> <li>▪ Oscillation damping 2</li> <li>▪ Density</li> <li>▪ Oil density</li> <li>▪ Water density</li> <li>▪ Dynamic viscosity</li> <li>▪ Sensor electronic temperature (ISEM)</li> <li>▪ <b>Empty pipe detection</b> option</li> <li>▪ GSV flow</li> <li>▪ GSV flow alternative</li> <li>▪ Kinematic viscosity</li> <li>▪ <b>Low flow cut off</b> option</li> <li>▪ Mass flow</li> <li>▪ Oil mass flow</li> <li>▪ Water mass flow</li> <li>▪ HBSI</li> <li>▪ NSV flow</li> <li>▪ NSV flow alternative</li> <li>▪ External pressure</li> <li>▪ Exciter current 1</li> <li>▪ Exciter current 2</li> <li>▪ Oscillation frequency 1</li> <li>▪ Oscillation frequency 2</li> <li>▪ S&amp;W volume flow</li> <li>▪ Reference density</li> <li>▪ Reference density alternative</li> <li>▪ Corrected volume flow</li> <li>▪ Oil corrected volume flow</li> <li>▪ Water corrected volume flow</li> <li>▪ Oscillation damping fluctuation 1</li> <li>▪ Oscillation damping fluctuation 2</li> <li>▪ Frequency fluctuation 1</li> <li>▪ Frequency fluctuation 2</li> <li>▪ Target mass flow</li> <li>▪ Carrier volume flow</li> <li>▪ Target volume flow</li> <li>▪ Temp. compensated dynamic viscosity</li> <li>▪ Temp. compensated kinematic viscosity</li> <li>▪ Temperature</li> <li>▪ Status</li> <li>▪ Volume flow</li> <li>▪ Oil volume flow</li> <li>▪ Water volume flow</li> <li>▪ Water cut</li> </ul>			

1) Diagnostic behavior can be changed. This causes the overall status of the measured variable to change.



Diagnostic information		Remedy instructions	
No.	Short text		
144	Measuring error too high	1. Check or change sensor 2. Check process conditions	
	<b>Measured variable status [from the factory] <sup>1)</sup></b>		
	Quality		Bad
	Quality substatus		Maintenance alarm
	Coding (hex)		0x24 to 0x27
	Status signal		F
	Diagnostic behavior		Alarm
<b>Influenced measured variables</b>			
<ul style="list-style-type: none"> <li>▪ Oscillation amplitude 1</li> <li>▪ Oscillation amplitude 2</li> <li>▪ Signal asymmetry</li> <li>▪ Carrier mass flow</li> <li>▪ Carrier pipe temperature</li> <li>▪ Target corrected volume flow</li> <li>▪ Carrier corrected volume flow</li> <li>▪ Concentration</li> <li>▪ Oscillation damping 1</li> <li>▪ Oscillation damping 2</li> <li>▪ Density</li> <li>▪ Oil density</li> <li>▪ Water density</li> <li>▪ Dynamic viscosity</li> <li>▪ Sensor electronic temperature (ISEM)</li> <li>▪ <b>Empty pipe detection</b> option</li> <li>▪ GSV flow</li> <li>▪ GSV flow alternative</li> <li>▪ Kinematic viscosity</li> <li>▪ <b>Low flow cut off</b> option</li> <li>▪ Mass flow</li> <li>▪ Oil mass flow</li> <li>▪ Water mass flow</li> <li>▪ HBSI</li> <li>▪ NSV flow</li> <li>▪ NSV flow alternative</li> <li>▪ External pressure</li> <li>▪ Exciter current 1</li> <li>▪ Exciter current 2</li> <li>▪ Oscillation frequency 1</li> <li>▪ Oscillation frequency 2</li> <li>▪ S&amp;W volume flow</li> <li>▪ Reference density</li> <li>▪ Reference density alternative</li> <li>▪ Corrected volume flow</li> <li>▪ Oil corrected volume flow</li> <li>▪ Water corrected volume flow</li> <li>▪ Oscillation damping fluctuation 1</li> <li>▪ Oscillation damping fluctuation 2</li> <li>▪ Frequency fluctuation 1</li> <li>▪ Frequency fluctuation 2</li> <li>▪ Target mass flow</li> <li>▪ Carrier volume flow</li> <li>▪ Target volume flow</li> <li>▪ Temp. compensated dynamic viscosity</li> <li>▪ Temp. compensated kinematic viscosity</li> <li>▪ Temperature</li> <li>▪ Status</li> <li>▪ Volume flow</li> <li>▪ Oil volume flow</li> <li>▪ Water volume flow</li> <li>▪ Water cut</li> </ul>			

1) Diagnostic behavior can be changed. This causes the overall status of the measured variable to change.

## 12.7.2 Diagnostic of electronic

Diagnostic information		Remedy instructions
No.	Short text	
201	Device failure	1. Restart device 2. Contact service
<b>Measured variable status</b>		
Quality	Bad	
Quality substatus	Maintenance alarm	
Coding (hex)	0x24 to 0x27	
Status signal	F	
Diagnostic behavior	Alarm	
<b>Influenced measured variables</b>		
<ul style="list-style-type: none"> <li>▪ Oscillation amplitude 1</li> <li>▪ Oscillation amplitude 2</li> <li>▪ Signal asymmetry</li> <li>▪ Carrier mass flow</li> <li>▪ Carrier pipe temperature</li> <li>▪ Target corrected volume flow</li> <li>▪ Carrier corrected volume flow</li> <li>▪ Concentration</li> <li>▪ Measured values 1</li> <li>▪ Measured values 2</li> <li>▪ Measured values 3</li> <li>▪ Oscillation damping 1</li> <li>▪ Oscillation damping 2</li> <li>▪ Density</li> <li>▪ Oil density</li> <li>▪ Water density</li> <li>▪ Dynamic viscosity</li> <li>▪ Sensor electronic temperature (ISEM)</li> <li>▪ <b>Empty pipe detection</b> option</li> </ul>		<ul style="list-style-type: none"> <li>▪ GSV flow</li> <li>▪ GSV flow alternative</li> <li>▪ Kinematic viscosity</li> <li>▪ <b>Low flow cut off</b> option</li> <li>▪ Mass flow</li> <li>▪ Oil mass flow</li> <li>▪ Water mass flow</li> <li>▪ HBSI</li> <li>▪ NSV flow</li> <li>▪ NSV flow alternative</li> <li>▪ External pressure</li> <li>▪ Exciter current 1</li> <li>▪ Exciter current 2</li> <li>▪ Oscillation frequency 1</li> <li>▪ Oscillation frequency 2</li> <li>▪ S&amp;W volume flow</li> <li>▪ Reference density</li> <li>▪ Reference density alternative</li> <li>▪ Corrected volume flow</li> </ul>
		<ul style="list-style-type: none"> <li>▪ Oil corrected volume flow</li> <li>▪ Water corrected volume flow</li> <li>▪ Oscillation damping fluctuation 1</li> <li>▪ Oscillation damping fluctuation 2</li> <li>▪ Frequency fluctuation 1</li> <li>▪ Frequency fluctuation 2</li> <li>▪ Target mass flow</li> <li>▪ Carrier volume flow</li> <li>▪ Target volume flow</li> <li>▪ Temp. compensated dynamic viscosity</li> <li>▪ Temp. compensated kinematic viscosity</li> <li>▪ Temperature</li> <li>▪ Status</li> <li>▪ Volume flow</li> <li>▪ Oil volume flow</li> <li>▪ Water volume flow</li> <li>▪ Water cut</li> </ul>

Diagnostic information		Remedy instructions	
No.	Short text		
242	Software incompatible	1. Check software 2. Flash or change main electronics module	
	<b>Measured variable status</b>		
	Quality		Bad
	Quality substatus		Maintenance alarm
	Coding (hex)		0x24 to 0x27
	Status signal		F
	Diagnostic behavior		Alarm
<b>Influenced measured variables</b>			
<ul style="list-style-type: none"> <li>▪ Oscillation amplitude 1</li> <li>▪ Oscillation amplitude 2</li> <li>▪ Signal asymmetry</li> <li>▪ Carrier mass flow</li> <li>▪ Carrier pipe temperature</li> <li>▪ Target corrected volume flow</li> <li>▪ Carrier corrected volume flow</li> <li>▪ Concentration</li> <li>▪ Measured values 1</li> <li>▪ Measured values 2</li> <li>▪ Measured values 3</li> <li>▪ Oscillation damping 1</li> <li>▪ Oscillation damping 2</li> <li>▪ Density</li> <li>▪ Oil density</li> <li>▪ Water density</li> <li>▪ Dynamic viscosity</li> <li>▪ Sensor electronic temperature (ISEM)</li> <li>▪ <b>Empty pipe detection</b> option</li> <li>▪ GSV flow</li> <li>▪ GSV flow alternative</li> <li>▪ Kinematic viscosity</li> <li>▪ <b>Low flow cut off</b> option</li> <li>▪ Mass flow</li> <li>▪ Oil mass flow</li> <li>▪ Water mass flow</li> <li>▪ HBSI</li> <li>▪ NSV flow</li> <li>▪ NSV flow alternative</li> <li>▪ External pressure</li> <li>▪ Exciter current 1</li> <li>▪ Exciter current 2</li> <li>▪ Oscillation frequency 1</li> <li>▪ Oscillation frequency 2</li> <li>▪ S&amp;W volume flow</li> <li>▪ Reference density</li> <li>▪ Reference density alternative</li> <li>▪ Corrected volume flow</li> <li>▪ Oil corrected volume flow</li> <li>▪ Water corrected volume flow</li> <li>▪ Oscillation damping fluctuation 1</li> <li>▪ Oscillation damping fluctuation 2</li> <li>▪ Frequency fluctuation 1</li> <li>▪ Frequency fluctuation 2</li> <li>▪ Target mass flow</li> <li>▪ Carrier volume flow</li> <li>▪ Target volume flow</li> <li>▪ Temp. compensated dynamic viscosity</li> <li>▪ Temp. compensated kinematic viscosity</li> <li>▪ Temperature</li> <li>▪ Status</li> <li>▪ Volume flow</li> <li>▪ Oil volume flow</li> <li>▪ Water volume flow</li> <li>▪ Water cut</li> </ul>			

Diagnostic information		Remedy instructions	
No.	Short text		
252	Modules incompatible	1. Check electronic modules 2. Check if correct modules are available (e.g. NEx, Ex) 3. Replace electronic modules	
	<b>Measured variable status</b>		
	Quality		Bad
	Quality substatus		Maintenance alarm
	Coding (hex)		0x24 to 0x27
	Status signal		F
	Diagnostic behavior		Alarm
	<b>Influenced measured variables</b>		
<ul style="list-style-type: none"> <li>▪ Oscillation amplitude 1</li> <li>▪ Oscillation amplitude 2</li> <li>▪ Signal asymmetry</li> <li>▪ Carrier mass flow</li> <li>▪ Carrier pipe temperature</li> <li>▪ Target corrected volume flow</li> <li>▪ Carrier corrected volume flow</li> <li>▪ Concentration</li> <li>▪ Measured values 1</li> <li>▪ Measured values 2</li> <li>▪ Measured values 3</li> <li>▪ Oscillation damping 1</li> <li>▪ Oscillation damping 2</li> <li>▪ Density</li> <li>▪ Oil density</li> <li>▪ Water density</li> <li>▪ Dynamic viscosity</li> <li>▪ Sensor electronic temperature (ISEM)</li> <li>▪ <b>Empty pipe detection</b> option</li> </ul>		<ul style="list-style-type: none"> <li>▪ GSV flow</li> <li>▪ GSV flow alternative</li> <li>▪ Kinematic viscosity</li> <li>▪ <b>Low flow cut off</b> option</li> <li>▪ Mass flow</li> <li>▪ Oil mass flow</li> <li>▪ Water mass flow</li> <li>▪ HBSI</li> <li>▪ NSV flow</li> <li>▪ NSV flow alternative</li> <li>▪ External pressure</li> <li>▪ Exciter current 1</li> <li>▪ Exciter current 2</li> <li>▪ Oscillation frequency 1</li> <li>▪ Oscillation frequency 2</li> <li>▪ S&amp;W volume flow</li> <li>▪ Reference density</li> <li>▪ Reference density alternative</li> <li>▪ Corrected volume flow</li> </ul>	
<ul style="list-style-type: none"> <li>▪ Oil corrected volume flow</li> <li>▪ Water corrected volume flow</li> <li>▪ Oscillation damping fluctuation 1</li> <li>▪ Oscillation damping fluctuation 2</li> <li>▪ Frequency fluctuation 1</li> <li>▪ Frequency fluctuation 2</li> <li>▪ Target mass flow</li> <li>▪ Carrier volume flow</li> <li>▪ Target volume flow</li> <li>▪ Temp. compensated dynamic viscosity</li> <li>▪ Temp. compensated kinematic viscosity</li> <li>▪ Temperature</li> <li>▪ Status</li> <li>▪ Volume flow</li> <li>▪ Oil volume flow</li> <li>▪ Water volume flow</li> <li>▪ Water cut</li> </ul>			

Diagnostic information		Remedy instructions	
No.	Short text		
252	Modules incompatible	1. Check if correct electronic modul is plugged 2. Replace electronic module	
	<b>Measured variable status</b>		
	Quality		Bad
	Quality substatus		Maintenance alarm
	Coding (hex)		0x24 to 0x27
	Status signal		F
	Diagnostic behavior		Alarm
	<b>Influenced measured variables</b>		
<ul style="list-style-type: none"> <li>▪ Oscillation amplitude 1</li> <li>▪ Oscillation amplitude 2</li> <li>▪ Signal asymmetry</li> <li>▪ Carrier mass flow</li> <li>▪ Carrier pipe temperature</li> <li>▪ Concentration</li> <li>▪ Measured values 1</li> <li>▪ Measured values 2</li> <li>▪ Measured values 3</li> <li>▪ Oscillation damping 1</li> <li>▪ Oscillation damping 2</li> <li>▪ Density</li> </ul>		<ul style="list-style-type: none"> <li>▪ Dynamic viscosity</li> <li>▪ Sensor electronic temperature (ISEM)</li> <li>▪ <b>Empty pipe detection</b> option</li> <li>▪ Kinematic viscosity</li> <li>▪ <b>Low flow cut off</b> option</li> <li>▪ Mass flow</li> <li>▪ HBSI</li> <li>▪ External pressure</li> <li>▪ Exciter current 1</li> <li>▪ Exciter current 2</li> <li>▪ Oscillation frequency 1</li> <li>▪ Oscillation frequency 2</li> </ul>	
<ul style="list-style-type: none"> <li>▪ Reference density</li> <li>▪ Corrected volume flow</li> <li>▪ Oscillation damping fluctuation 1</li> <li>▪ Oscillation damping fluctuation 2</li> <li>▪ Frequency fluctuation 1</li> <li>▪ Frequency fluctuation 2</li> <li>▪ Target mass flow</li> <li>▪ Temp. compensated dynamic viscosity</li> <li>▪ Temp. compensated kinematic viscosity</li> <li>▪ Temperature</li> <li>▪ Status</li> <li>▪ Volume flow</li> </ul>			

Diagnostic information		Remedy instructions	
No.	Short text		
262	Sensor electronic connection faulty	1. Check or replace connection cable between sensor electronic module (ISEM) and main electronics 2. Check or replace ISEM or main electronics	
	<b>Measured variable status</b>		
	Quality		Bad
	Quality substatus		Maintenance alarm
	Coding (hex)		0x24 to 0x27
	Status signal		F
	Diagnostic behavior		Alarm
<b>Influenced measured variables</b>			
<ul style="list-style-type: none"> <li>▪ Oscillation amplitude 1</li> <li>▪ Oscillation amplitude 2</li> <li>▪ Signal asymmetry</li> <li>▪ Carrier mass flow</li> <li>▪ Carrier pipe temperature</li> <li>▪ Target corrected volume flow</li> <li>▪ Carrier corrected volume flow</li> <li>▪ Concentration</li> <li>▪ Measured values 1</li> <li>▪ Measured values 2</li> <li>▪ Measured values 3</li> <li>▪ Oscillation damping 1</li> <li>▪ Oscillation damping 2</li> <li>▪ Density</li> <li>▪ Oil density</li> <li>▪ Water density</li> <li>▪ Dynamic viscosity</li> <li>▪ Sensor electronic temperature (ISEM)</li> <li>▪ <b>Empty pipe detection</b> option</li> </ul>		<ul style="list-style-type: none"> <li>▪ GSV flow</li> <li>▪ GSV flow alternative</li> <li>▪ Kinematic viscosity</li> <li>▪ <b>Low flow cut off</b> option</li> <li>▪ Mass flow</li> <li>▪ Oil mass flow</li> <li>▪ Water mass flow</li> <li>▪ HBSI</li> <li>▪ NSV flow</li> <li>▪ NSV flow alternative</li> <li>▪ External pressure</li> <li>▪ Exciter current 1</li> <li>▪ Exciter current 2</li> <li>▪ Oscillation frequency 1</li> <li>▪ Oscillation frequency 2</li> <li>▪ S&amp;W volume flow</li> <li>▪ Reference density</li> <li>▪ Reference density alternative</li> <li>▪ Corrected volume flow</li> </ul>	
<ul style="list-style-type: none"> <li>▪ Oil corrected volume flow</li> <li>▪ Water corrected volume flow</li> <li>▪ Oscillation damping fluctuation 1</li> <li>▪ Oscillation damping fluctuation 2</li> <li>▪ Frequency fluctuation 1</li> <li>▪ Frequency fluctuation 2</li> <li>▪ Target mass flow</li> <li>▪ Carrier volume flow</li> <li>▪ Target volume flow</li> <li>▪ Temp. compensated dynamic viscosity</li> <li>▪ Temp. compensated kinematic viscosity</li> <li>▪ Temperature</li> <li>▪ Status</li> <li>▪ Volume flow</li> <li>▪ Oil volume flow</li> <li>▪ Water volume flow</li> <li>▪ Water cut</li> </ul>			

Diagnostic information		Remedy instructions
No.	Short text	
270	Main electronic failure	Change main electronic module
<b>Measured variable status</b>		
Quality	Bad	
Quality substatus	Maintenance alarm	
Coding (hex)	0x24 to 0x27	
Status signal	F	
Diagnostic behavior	Alarm	
<b>Influenced measured variables</b>		
<ul style="list-style-type: none"> <li>▪ Oscillation amplitude 1</li> <li>▪ Oscillation amplitude 2</li> <li>▪ Signal asymmetry</li> <li>▪ Carrier mass flow</li> <li>▪ Carrier pipe temperature</li> <li>▪ Target corrected volume flow</li> <li>▪ Carrier corrected volume flow</li> <li>▪ Concentration</li> <li>▪ Measured values 1</li> <li>▪ Measured values 2</li> <li>▪ Measured values 3</li> <li>▪ Oscillation damping 1</li> <li>▪ Oscillation damping 2</li> <li>▪ Density</li> <li>▪ Oil density</li> <li>▪ Water density</li> <li>▪ Dynamic viscosity</li> <li>▪ Sensor electronic temperature (ISEM)</li> <li>▪ <b>Empty pipe detection</b> option</li> </ul>		<ul style="list-style-type: none"> <li>▪ GSV flow</li> <li>▪ GSV flow alternative</li> <li>▪ Kinematic viscosity</li> <li>▪ <b>Low flow cut off</b> option</li> <li>▪ Mass flow</li> <li>▪ Oil mass flow</li> <li>▪ Water mass flow</li> <li>▪ HBSI</li> <li>▪ NSV flow</li> <li>▪ NSV flow alternative</li> <li>▪ External pressure</li> <li>▪ Exciter current 1</li> <li>▪ Exciter current 2</li> <li>▪ Oscillation frequency 1</li> <li>▪ Oscillation frequency 2</li> <li>▪ S&amp;W volume flow</li> <li>▪ Reference density</li> <li>▪ Reference density alternative</li> <li>▪ Corrected volume flow</li> </ul>
		<ul style="list-style-type: none"> <li>▪ Oil corrected volume flow</li> <li>▪ Water corrected volume flow</li> <li>▪ Oscillation damping fluctuation 1</li> <li>▪ Oscillation damping fluctuation 2</li> <li>▪ Frequency fluctuation 1</li> <li>▪ Frequency fluctuation 2</li> <li>▪ Target mass flow</li> <li>▪ Carrier volume flow</li> <li>▪ Target volume flow</li> <li>▪ Temp. compensated dynamic viscosity</li> <li>▪ Temp. compensated kinematic viscosity</li> <li>▪ Temperature</li> <li>▪ Status</li> <li>▪ Volume flow</li> <li>▪ Oil volume flow</li> <li>▪ Water volume flow</li> <li>▪ Water cut</li> </ul>

Diagnostic information		Remedy instructions	
No.	Short text		
271	Main electronic failure	1. Restart device 2. Change main electronic module	
	<b>Measured variable status</b>		
	Quality		Bad
	Quality substatus		Maintenance alarm
	Coding (hex)		0x24 to 0x27
	Status signal		F
	Diagnostic behavior		Alarm
<b>Influenced measured variables</b>			
<ul style="list-style-type: none"> <li>▪ Oscillation amplitude 1</li> <li>▪ Oscillation amplitude 2</li> <li>▪ Signal asymmetry</li> <li>▪ Carrier mass flow</li> <li>▪ Carrier pipe temperature</li> <li>▪ Target corrected volume flow</li> <li>▪ Carrier corrected volume flow</li> <li>▪ Concentration</li> <li>▪ Measured values 1</li> <li>▪ Measured values 2</li> <li>▪ Measured values 3</li> <li>▪ Oscillation damping 1</li> <li>▪ Oscillation damping 2</li> <li>▪ Density</li> <li>▪ Oil density</li> <li>▪ Water density</li> <li>▪ Dynamic viscosity</li> <li>▪ Sensor electronic temperature (ISEM)</li> <li>▪ <b>Empty pipe detection</b> option</li> <li>▪ GSV flow</li> <li>▪ GSV flow alternative</li> <li>▪ Kinematic viscosity</li> <li>▪ <b>Low flow cut off</b> option</li> <li>▪ Mass flow</li> <li>▪ Oil mass flow</li> <li>▪ Water mass flow</li> <li>▪ HBSI</li> <li>▪ NSV flow</li> <li>▪ NSV flow alternative</li> <li>▪ External pressure</li> <li>▪ Exciter current 1</li> <li>▪ Exciter current 2</li> <li>▪ Oscillation frequency 1</li> <li>▪ Oscillation frequency 2</li> <li>▪ S&amp;W volume flow</li> <li>▪ Reference density</li> <li>▪ Reference density alternative</li> <li>▪ Corrected volume flow</li> <li>▪ Oil corrected volume flow</li> <li>▪ Water corrected volume flow</li> <li>▪ Oscillation damping fluctuation 1</li> <li>▪ Oscillation damping fluctuation 2</li> <li>▪ Frequency fluctuation 1</li> <li>▪ Frequency fluctuation 2</li> <li>▪ Target mass flow</li> <li>▪ Carrier volume flow</li> <li>▪ Target volume flow</li> <li>▪ Temp. compensated dynamic viscosity</li> <li>▪ Temp. compensated kinematic viscosity</li> <li>▪ Temperature</li> <li>▪ Status</li> <li>▪ Volume flow</li> <li>▪ Oil volume flow</li> <li>▪ Water volume flow</li> <li>▪ Water cut</li> </ul>			

Diagnostic information		Remedy instructions
No.	Short text	
272	Main electronic failure	1. Restart device 2. Contact service
<b>Measured variable status</b>		
Quality	Bad	
Quality substatus	Maintenance alarm	
Coding (hex)	0x24 to 0x27	
Status signal	F	
Diagnostic behavior	Alarm	
<b>Influenced measured variables</b>		
<ul style="list-style-type: none"> <li>▪ Oscillation amplitude 1</li> <li>▪ Oscillation amplitude 2</li> <li>▪ Signal asymmetry</li> <li>▪ Carrier mass flow</li> <li>▪ Carrier pipe temperature</li> <li>▪ Target corrected volume flow</li> <li>▪ Carrier corrected volume flow</li> <li>▪ Concentration</li> <li>▪ Measured values 1</li> <li>▪ Measured values 2</li> <li>▪ Measured values 3</li> <li>▪ Oscillation damping 1</li> <li>▪ Oscillation damping 2</li> <li>▪ Density</li> <li>▪ Oil density</li> <li>▪ Water density</li> <li>▪ Dynamic viscosity</li> <li>▪ Sensor electronic temperature (ISEM)</li> <li>▪ <b>Empty pipe detection</b> option</li> </ul>		<ul style="list-style-type: none"> <li>▪ GSV flow</li> <li>▪ GSV flow alternative</li> <li>▪ Kinematic viscosity</li> <li>▪ <b>Low flow cut off</b> option</li> <li>▪ Mass flow</li> <li>▪ Oil mass flow</li> <li>▪ Water mass flow</li> <li>▪ HBSI</li> <li>▪ NSV flow</li> <li>▪ NSV flow alternative</li> <li>▪ External pressure</li> <li>▪ Exciter current 1</li> <li>▪ Exciter current 2</li> <li>▪ Oscillation frequency 1</li> <li>▪ Oscillation frequency 2</li> <li>▪ S&amp;W volume flow</li> <li>▪ Reference density</li> <li>▪ Reference density alternative</li> <li>▪ Corrected volume flow</li> </ul>
		<ul style="list-style-type: none"> <li>▪ Oil corrected volume flow</li> <li>▪ Water corrected volume flow</li> <li>▪ Oscillation damping fluctuation 1</li> <li>▪ Oscillation damping fluctuation 2</li> <li>▪ Frequency fluctuation 1</li> <li>▪ Frequency fluctuation 2</li> <li>▪ Target mass flow</li> <li>▪ Carrier volume flow</li> <li>▪ Target volume flow</li> <li>▪ Temp. compensated dynamic viscosity</li> <li>▪ Temp. compensated kinematic viscosity</li> <li>▪ Temperature</li> <li>▪ Status</li> <li>▪ Volume flow</li> <li>▪ Oil volume flow</li> <li>▪ Water volume flow</li> <li>▪ Water cut</li> </ul>



Diagnostic information		Remedy instructions	
No.	Short text		
273	Main electronic failure	Change electronic	
	<b>Measured variable status</b>		
	Quality		Bad
	Quality substatus		Maintenance alarm
	Coding (hex)		0x24 to 0x27
	Status signal		F
	Diagnostic behavior		Alarm
<b>Influenced measured variables</b>			
<ul style="list-style-type: none"> <li>▪ Oscillation amplitude 1</li> <li>▪ Oscillation amplitude 2</li> <li>▪ Signal asymmetry</li> <li>▪ Carrier mass flow</li> <li>▪ Carrier pipe temperature</li> <li>▪ Target corrected volume flow</li> <li>▪ Carrier corrected volume flow</li> <li>▪ Concentration</li> <li>▪ Measured values 1</li> <li>▪ Measured values 2</li> <li>▪ Measured values 3</li> <li>▪ Oscillation damping 1</li> <li>▪ Oscillation damping 2</li> <li>▪ Density</li> <li>▪ Oil density</li> <li>▪ Water density</li> <li>▪ Dynamic viscosity</li> <li>▪ Sensor electronic temperature (ISEM)</li> <li>▪ <b>Empty pipe detection</b> option</li> <li>▪ GSV flow</li> <li>▪ GSV flow alternative</li> <li>▪ Kinematic viscosity</li> <li>▪ <b>Low flow cut off</b> option</li> <li>▪ Mass flow</li> <li>▪ Oil mass flow</li> <li>▪ Water mass flow</li> <li>▪ HBSI</li> <li>▪ NSV flow</li> <li>▪ NSV flow alternative</li> <li>▪ External pressure</li> <li>▪ Exciter current 1</li> <li>▪ Exciter current 2</li> <li>▪ Oscillation frequency 1</li> <li>▪ Oscillation frequency 2</li> <li>▪ S&amp;W volume flow</li> <li>▪ Reference density</li> <li>▪ Reference density alternative</li> <li>▪ Corrected volume flow</li> <li>▪ Oil corrected volume flow</li> <li>▪ Water corrected volume flow</li> <li>▪ Oscillation damping fluctuation 1</li> <li>▪ Oscillation damping fluctuation 2</li> <li>▪ Frequency fluctuation 1</li> <li>▪ Frequency fluctuation 2</li> <li>▪ Target mass flow</li> <li>▪ Carrier volume flow</li> <li>▪ Target volume flow</li> <li>▪ Temp. compensated dynamic viscosity</li> <li>▪ Temp. compensated kinematic viscosity</li> <li>▪ Temperature</li> <li>▪ Status</li> <li>▪ Volume flow</li> <li>▪ Oil volume flow</li> <li>▪ Water volume flow</li> <li>▪ Water cut</li> </ul>			

Diagnostic information		Remedy instructions	
No.	Short text		
275	I/O module 1 to n defective	Change I/O module	
	<b>Measured variable status</b>		
	Quality		Bad
	Quality substatus		Maintenance alarm
	Coding (hex)		0x24 to 0x27
	Status signal		F
	Diagnostic behavior		Alarm
<b>Influenced measured variables</b>			
<ul style="list-style-type: none"> <li>▪ Oscillation amplitude 1</li> <li>▪ Oscillation amplitude 2</li> <li>▪ Signal asymmetry</li> <li>▪ Carrier mass flow</li> <li>▪ Carrier pipe temperature</li> <li>▪ Concentration</li> <li>▪ Measured values 1</li> <li>▪ Measured values 2</li> <li>▪ Measured values 3</li> <li>▪ Oscillation damping 1</li> <li>▪ Oscillation damping 2</li> <li>▪ Density</li> <li>▪ Dynamic viscosity</li> <li>▪ Sensor electronic temperature (ISEM)</li> <li>▪ <b>Empty pipe detection</b> option</li> <li>▪ Kinematic viscosity</li> <li>▪ <b>Low flow cut off</b> option</li> <li>▪ Mass flow</li> <li>▪ HBSI</li> <li>▪ External pressure</li> <li>▪ Exciter current 1</li> <li>▪ Exciter current 2</li> <li>▪ Oscillation frequency 1</li> <li>▪ Oscillation frequency 2</li> <li>▪ Reference density</li> <li>▪ Corrected volume flow</li> <li>▪ Oscillation damping fluctuation 1</li> <li>▪ Oscillation damping fluctuation 2</li> <li>▪ Frequency fluctuation 1</li> <li>▪ Frequency fluctuation 2</li> <li>▪ Target mass flow</li> <li>▪ Temp. compensated dynamic viscosity</li> <li>▪ Temp. compensated kinematic viscosity</li> <li>▪ Temperature</li> <li>▪ Status</li> <li>▪ Volume flow</li> </ul>			

Diagnostic information		Remedy instructions	
No.	Short text		
276	I/O module 1 to n faulty	1. Restart device 2. Change I/O module	
	<b>Measured variable status</b>		
	Quality		Bad
	Quality substatus		Maintenance alarm
	Coding (hex)		0x24 to 0x27
	Status signal		F
	Diagnostic behavior		Alarm
<b>Influenced measured variables</b>			
<ul style="list-style-type: none"> <li>▪ Oscillation amplitude 1</li> <li>▪ Oscillation amplitude 2</li> <li>▪ Signal asymmetry</li> <li>▪ Carrier mass flow</li> <li>▪ Carrier pipe temperature</li> <li>▪ Target corrected volume flow</li> <li>▪ Carrier corrected volume flow</li> <li>▪ Concentration</li> <li>▪ Measured values 1</li> <li>▪ Measured values 2</li> <li>▪ Measured values 3</li> <li>▪ Oscillation damping 1</li> <li>▪ Oscillation damping 2</li> <li>▪ Density</li> <li>▪ Dynamic viscosity</li> <li>▪ Sensor electronic temperature (ISEM)</li> <li>▪ <b>Empty pipe detection</b> option</li> <li>▪ Kinematic viscosity</li> <li>▪ <b>Low flow cut off</b> option</li> <li>▪ Mass flow</li> <li>▪ HBSI</li> <li>▪ External pressure</li> <li>▪ Exciter current 1</li> <li>▪ Exciter current 2</li> <li>▪ Oscillation frequency 1</li> <li>▪ Oscillation frequency 2</li> <li>▪ Reference density</li> <li>▪ Corrected volume flow</li> <li>▪ Oscillation damping fluctuation 1</li> <li>▪ Oscillation damping fluctuation 2</li> <li>▪ Frequency fluctuation 1</li> <li>▪ Frequency fluctuation 2</li> <li>▪ Target mass flow</li> <li>▪ Carrier volume flow</li> <li>▪ Target volume flow</li> <li>▪ Temp. compensated dynamic viscosity</li> <li>▪ Temp. compensated kinematic viscosity</li> <li>▪ Temperature</li> <li>▪ Status</li> <li>▪ Volume flow</li> </ul>			

Diagnostic information		Remedy instructions	
No.	Short text		
283	Memory content	1. Reset device 2. Contact service	
	<b>Measured variable status</b>		
	Quality		Bad
	Quality substatus		Maintenance alarm
	Coding (hex)		0x24 to 0x27
	Status signal		F
	Diagnostic behavior		Alarm
<b>Influenced measured variables</b>			
<ul style="list-style-type: none"> <li>▪ Oscillation amplitude 1</li> <li>▪ Oscillation amplitude 2</li> <li>▪ Signal asymmetry</li> <li>▪ Carrier mass flow</li> <li>▪ Carrier pipe temperature</li> <li>▪ Target corrected volume flow</li> <li>▪ Carrier corrected volume flow</li> <li>▪ Concentration</li> <li>▪ Measured values 1</li> <li>▪ Measured values 2</li> <li>▪ Measured values 3</li> <li>▪ Oscillation damping 1</li> <li>▪ Oscillation damping 2</li> <li>▪ Density</li> <li>▪ Oil density</li> <li>▪ Water density</li> <li>▪ Dynamic viscosity</li> <li>▪ Sensor electronic temperature (ISEM)</li> <li>▪ <b>Empty pipe detection</b> option</li> <li>▪ GSV flow</li> <li>▪ GSV flow alternative</li> <li>▪ Kinematic viscosity</li> <li>▪ <b>Low flow cut off</b> option</li> <li>▪ Mass flow</li> <li>▪ Oil mass flow</li> <li>▪ Water mass flow</li> <li>▪ HBSI</li> <li>▪ NSV flow</li> <li>▪ NSV flow alternative</li> <li>▪ External pressure</li> <li>▪ Exciter current 1</li> <li>▪ Exciter current 2</li> <li>▪ Oscillation frequency 1</li> <li>▪ Oscillation frequency 2</li> <li>▪ S&amp;W volume flow</li> <li>▪ Reference density</li> <li>▪ Reference density alternative</li> <li>▪ Corrected volume flow</li> <li>▪ Oil corrected volume flow</li> <li>▪ Water corrected volume flow</li> <li>▪ Oscillation damping fluctuation 1</li> <li>▪ Oscillation damping fluctuation 2</li> <li>▪ Frequency fluctuation 1</li> <li>▪ Frequency fluctuation 2</li> <li>▪ Target mass flow</li> <li>▪ Carrier volume flow</li> <li>▪ Target volume flow</li> <li>▪ Temp. compensated dynamic viscosity</li> <li>▪ Temp. compensated kinematic viscosity</li> <li>▪ Temperature</li> <li>▪ Status</li> <li>▪ Volume flow</li> <li>▪ Oil volume flow</li> <li>▪ Water volume flow</li> <li>▪ Water cut</li> </ul>			

Diagnostic information		Remedy instructions	
No.	Short text		
302	Device verification active	Device verification active, please wait.	
	<b>Measured variable status</b>		
	Quality		Good
	Quality substatus		Function check
	Coding (hex)		0xBC to 0xBF
	Status signal		C
	Diagnostic behavior		Warning
<b>Influenced measured variables</b>			
<ul style="list-style-type: none"> <li>▪ Oscillation amplitude 1</li> <li>▪ Oscillation amplitude 2</li> <li>▪ Signal asymmetry</li> <li>▪ Carrier mass flow</li> <li>▪ Carrier pipe temperature</li> <li>▪ Target corrected volume flow</li> <li>▪ Carrier corrected volume flow</li> <li>▪ Concentration</li> <li>▪ Measured values 1</li> <li>▪ Measured values 2</li> <li>▪ Measured values 3</li> <li>▪ Oscillation damping 1</li> <li>▪ Oscillation damping 2</li> <li>▪ Density</li> <li>▪ Oil density</li> <li>▪ Water density</li> <li>▪ Dynamic viscosity</li> <li>▪ Sensor electronic temperature (ISEM)</li> <li>▪ <b>Empty pipe detection</b> option</li> </ul>		<ul style="list-style-type: none"> <li>▪ GSV flow</li> <li>▪ GSV flow alternative</li> <li>▪ Kinematic viscosity</li> <li>▪ <b>Low flow cut off</b> option</li> <li>▪ Mass flow</li> <li>▪ Oil mass flow</li> <li>▪ Water mass flow</li> <li>▪ HBSI</li> <li>▪ NSV flow</li> <li>▪ NSV flow alternative</li> <li>▪ External pressure</li> <li>▪ Exciter current 1</li> <li>▪ Exciter current 2</li> <li>▪ Oscillation frequency 1</li> <li>▪ Oscillation frequency 2</li> <li>▪ S&amp;W volume flow</li> <li>▪ Reference density</li> <li>▪ Reference density alternative</li> <li>▪ Corrected volume flow</li> </ul>	
		<ul style="list-style-type: none"> <li>▪ Oil corrected volume flow</li> <li>▪ Water corrected volume flow</li> <li>▪ Oscillation damping fluctuation 1</li> <li>▪ Oscillation damping fluctuation 2</li> <li>▪ Frequency fluctuation 1</li> <li>▪ Frequency fluctuation 2</li> <li>▪ Target mass flow</li> <li>▪ Carrier volume flow</li> <li>▪ Target volume flow</li> <li>▪ Temp. compensated dynamic viscosity</li> <li>▪ Temp. compensated kinematic viscosity</li> <li>▪ Temperature</li> <li>▪ Status</li> <li>▪ Volume flow</li> <li>▪ Oil volume flow</li> <li>▪ Water volume flow</li> <li>▪ Water cut</li> </ul>	

Diagnostic information		Remedy instructions	
No.	Short text		
303	I/O 1 to n configuration changed	1. Apply I/O module configuration (parameter 'Apply I/O configuration') 2. Afterwards reload device description and check wiring	
	<b>Measured variable status</b>		
	Quality		Bad
	Quality substatus		Maintenance alarm
	Coding (hex)		0x24 to 0x27
	Status signal		M
	Diagnostic behavior		Warning
<b>Influenced measured variables</b>			
-			

Diagnostic information		Remedy instructions	
No.	Short text		
311	Electronic failure	1. Do not reset device 2. Contact service	
	<b>Measured variable status</b>		
	Quality		Bad
	Quality substatus		Maintenance alarm
	Coding (hex)		0x24 to 0x27
	Status signal		M
	Diagnostic behavior		Warning
<b>Influenced measured variables</b>			
<ul style="list-style-type: none"> <li>▪ Oscillation amplitude 1</li> <li>▪ Oscillation amplitude 2</li> <li>▪ Signal asymmetry</li> <li>▪ Carrier mass flow</li> <li>▪ Carrier pipe temperature</li> <li>▪ Target corrected volume flow</li> <li>▪ Carrier corrected volume flow</li> <li>▪ Concentration</li> <li>▪ Measured values 1</li> <li>▪ Measured values 2</li> <li>▪ Measured values 3</li> <li>▪ Oscillation damping 1</li> <li>▪ Oscillation damping 2</li> <li>▪ Density</li> <li>▪ Oil density</li> <li>▪ Water density</li> <li>▪ Dynamic viscosity</li> <li>▪ Sensor electronic temperature (ISEM)</li> <li>▪ <b>Empty pipe detection</b> option</li> <li>▪ GSV flow</li> <li>▪ GSV flow alternative</li> <li>▪ Kinematic viscosity</li> <li>▪ <b>Low flow cut off</b> option</li> <li>▪ Mass flow</li> <li>▪ Oil mass flow</li> <li>▪ Water mass flow</li> <li>▪ HBSI</li> <li>▪ NSV flow</li> <li>▪ NSV flow alternative</li> <li>▪ External pressure</li> <li>▪ Exciter current 1</li> <li>▪ Exciter current 2</li> <li>▪ Oscillation frequency 1</li> <li>▪ Oscillation frequency 2</li> <li>▪ S&amp;W volume flow</li> <li>▪ Reference density</li> <li>▪ Reference density alternative</li> <li>▪ Corrected volume flow</li> <li>▪ Oil corrected volume flow</li> <li>▪ Water corrected volume flow</li> <li>▪ Oscillation damping fluctuation 1</li> <li>▪ Oscillation damping fluctuation 2</li> <li>▪ Frequency fluctuation 1</li> <li>▪ Frequency fluctuation 2</li> <li>▪ Target mass flow</li> <li>▪ Carrier volume flow</li> <li>▪ Target volume flow</li> <li>▪ Temp. compensated dynamic viscosity</li> <li>▪ Temp. compensated kinematic viscosity</li> <li>▪ Temperature</li> <li>▪ Status</li> <li>▪ Volume flow</li> <li>▪ Oil volume flow</li> <li>▪ Water volume flow</li> <li>▪ Water cut</li> </ul>			

Diagnostic information		Remedy instructions	
No.	Short text		
332	Writing in HistoROM backup failed	Replace user interface board Ex d/XP: replace transmitter	
	<b>Measured variable status</b>		
	Quality		Bad
	Quality substatus		Maintenance alarm
	Coding (hex)		0x24 to 0x27
	Status signal		F
	Diagnostic behavior		Alarm
<b>Influenced measured variables</b>			
<ul style="list-style-type: none"> <li>▪ Oscillation amplitude 1</li> <li>▪ Oscillation amplitude 2</li> <li>▪ Signal asymmetry</li> <li>▪ Carrier mass flow</li> <li>▪ Carrier pipe temperature</li> <li>▪ Target corrected volume flow</li> <li>▪ Carrier corrected volume flow</li> <li>▪ Concentration</li> <li>▪ Oscillation damping 1</li> <li>▪ Oscillation damping 2</li> <li>▪ Density</li> <li>▪ Oil density</li> <li>▪ Water density</li> <li>▪ Dynamic viscosity</li> <li>▪ Sensor electronic temperature (ISEM)</li> <li>▪ <b>Empty pipe detection</b> option</li> <li>▪ GSV flow</li> <li>▪ GSV flow alternative</li> </ul>		<ul style="list-style-type: none"> <li>▪ Kinematic viscosity</li> <li>▪ <b>Low flow cut off</b> option</li> <li>▪ Mass flow</li> <li>▪ Oil mass flow</li> <li>▪ Water mass flow</li> <li>▪ HBSI</li> <li>▪ NSV flow</li> <li>▪ NSV flow alternative</li> <li>▪ External pressure</li> <li>▪ Exciter current 1</li> <li>▪ Exciter current 2</li> <li>▪ Oscillation frequency 1</li> <li>▪ Oscillation frequency 2</li> <li>▪ S&amp;W volume flow</li> <li>▪ Reference density</li> <li>▪ Reference density alternative</li> <li>▪ Corrected volume flow</li> <li>▪ Oil corrected volume flow</li> </ul>	
		<ul style="list-style-type: none"> <li>▪ Water corrected volume flow</li> <li>▪ Oscillation damping fluctuation 1</li> <li>▪ Oscillation damping fluctuation 2</li> <li>▪ Frequency fluctuation 1</li> <li>▪ Frequency fluctuation 2</li> <li>▪ Target mass flow</li> <li>▪ Carrier volume flow</li> <li>▪ Target volume flow</li> <li>▪ Temp. compensated dynamic viscosity</li> <li>▪ Temp. compensated kinematic viscosity</li> <li>▪ Temperature</li> <li>▪ Status</li> <li>▪ Volume flow</li> <li>▪ Oil volume flow</li> <li>▪ Water volume flow</li> <li>▪ Water cut</li> </ul>	

Diagnostic information		Remedy instructions	
No.	Short text		
361	I/O module 1 to n faulty	1. Restart device 2. Check electronic modules 3. Change I/O Modul or main electronics	
	<b>Measured variable status</b>		
	Quality		Bad
	Quality substatus		Maintenance alarm
	Coding (hex)		0x24 to 0x27
	Status signal		F
	Diagnostic behavior		Alarm
<b>Influenced measured variables</b>			
<ul style="list-style-type: none"> <li>▪ Oscillation amplitude 1</li> <li>▪ Oscillation amplitude 2</li> <li>▪ Signal asymmetry</li> <li>▪ Carrier mass flow</li> <li>▪ Carrier pipe temperature</li> <li>▪ Concentration</li> <li>▪ Measured values 1</li> <li>▪ Measured values 2</li> <li>▪ Measured values 3</li> <li>▪ Oscillation damping 1</li> <li>▪ Oscillation damping 2</li> <li>▪ Density</li> </ul>		<ul style="list-style-type: none"> <li>▪ Dynamic viscosity</li> <li>▪ Sensor electronic temperature (ISEM)</li> <li>▪ <b>Empty pipe detection</b> option</li> <li>▪ Kinematic viscosity</li> <li>▪ <b>Low flow cut off</b> option</li> <li>▪ Mass flow</li> <li>▪ HBSI</li> <li>▪ External pressure</li> <li>▪ Exciter current 1</li> <li>▪ Exciter current 2</li> <li>▪ Oscillation frequency 1</li> <li>▪ Oscillation frequency 2</li> </ul>	
		<ul style="list-style-type: none"> <li>▪ Reference density</li> <li>▪ Corrected volume flow</li> <li>▪ Oscillation damping fluctuation 1</li> <li>▪ Oscillation damping fluctuation 2</li> <li>▪ Frequency fluctuation 1</li> <li>▪ Frequency fluctuation 2</li> <li>▪ Target mass flow</li> <li>▪ Temp. compensated dynamic viscosity</li> <li>▪ Temp. compensated kinematic viscosity</li> <li>▪ Temperature</li> <li>▪ Status</li> <li>▪ Volume flow</li> </ul>	

Diagnostic information		Remedy instructions	
No.	Short text		
372	Sensor electronic (ISEM) faulty	1. Restart device 2. Check if failure recurs 3. Replace sensor electronic module (ISEM)	
<b>Measured variable status</b>			
Quality	Bad		
Quality substatus	Maintenance alarm		
Coding (hex)	0x24 to 0x27		
Status signal	F		
Diagnostic behavior	Alarm		
<b>Influenced measured variables</b>			
<ul style="list-style-type: none"> <li>▪ Oscillation amplitude 1</li> <li>▪ Oscillation amplitude 2</li> <li>▪ Signal asymmetry</li> <li>▪ Carrier mass flow</li> <li>▪ Carrier pipe temperature</li> <li>▪ Target corrected volume flow</li> <li>▪ Carrier corrected volume flow</li> <li>▪ Concentration</li> <li>▪ Measured values 1</li> <li>▪ Measured values 2</li> <li>▪ Measured values 3</li> <li>▪ Oscillation damping 1</li> <li>▪ Oscillation damping 2</li> <li>▪ Density</li> <li>▪ Oil density</li> <li>▪ Water density</li> <li>▪ Dynamic viscosity</li> <li>▪ Sensor electronic temperature (ISEM)</li> <li>▪ <b>Empty pipe detection</b> option</li> </ul>		<ul style="list-style-type: none"> <li>▪ GSV flow</li> <li>▪ GSV flow alternative</li> <li>▪ Kinematic viscosity</li> <li>▪ <b>Low flow cut off</b> option</li> <li>▪ Mass flow</li> <li>▪ Oil mass flow</li> <li>▪ Water mass flow</li> <li>▪ HBSI</li> <li>▪ NSV flow</li> <li>▪ NSV flow alternative</li> <li>▪ External pressure</li> <li>▪ Exciter current 1</li> <li>▪ Exciter current 2</li> <li>▪ Oscillation frequency 1</li> <li>▪ Oscillation frequency 2</li> <li>▪ S&amp;W volume flow</li> <li>▪ Reference density</li> <li>▪ Reference density alternative</li> <li>▪ Corrected volume flow</li> </ul>	<ul style="list-style-type: none"> <li>▪ Oil corrected volume flow</li> <li>▪ Water corrected volume flow</li> <li>▪ Oscillation damping fluctuation 1</li> <li>▪ Oscillation damping fluctuation 2</li> <li>▪ Frequency fluctuation 1</li> <li>▪ Frequency fluctuation 2</li> <li>▪ Target mass flow</li> <li>▪ Carrier volume flow</li> <li>▪ Target volume flow</li> <li>▪ Temp. compensated dynamic viscosity</li> <li>▪ Temp. compensated kinematic viscosity</li> <li>▪ Temperature</li> <li>▪ Status</li> <li>▪ Volume flow</li> <li>▪ Oil volume flow</li> <li>▪ Water volume flow</li> <li>▪ Water cut</li> </ul>

Diagnostic information		Remedy instructions	
No.	Short text		
373	Sensor electronic (ISEM) faulty	1. Transfer data or reset device 2. Contact service	
	<b>Measured variable status</b>		
	Quality		Bad
	Quality substatus		Maintenance alarm
	Coding (hex)		0x24 to 0x27
	Status signal		F
	Diagnostic behavior		Alarm
<b>Influenced measured variables</b>			
<ul style="list-style-type: none"> <li>▪ Oscillation amplitude 1</li> <li>▪ Oscillation amplitude 2</li> <li>▪ Signal asymmetry</li> <li>▪ Carrier mass flow</li> <li>▪ Carrier pipe temperature</li> <li>▪ Target corrected volume flow</li> <li>▪ Carrier corrected volume flow</li> <li>▪ Concentration</li> <li>▪ Measured values 1</li> <li>▪ Measured values 2</li> <li>▪ Measured values 3</li> <li>▪ Oscillation damping 1</li> <li>▪ Oscillation damping 2</li> <li>▪ Density</li> <li>▪ Oil density</li> <li>▪ Water density</li> <li>▪ Dynamic viscosity</li> <li>▪ Sensor electronic temperature (ISEM)</li> <li>▪ <b>Empty pipe detection</b> option</li> </ul>		<ul style="list-style-type: none"> <li>▪ GSV flow</li> <li>▪ GSV flow alternative</li> <li>▪ Kinematic viscosity</li> <li>▪ <b>Low flow cut off</b> option</li> <li>▪ Mass flow</li> <li>▪ Oil mass flow</li> <li>▪ Water mass flow</li> <li>▪ HBSI</li> <li>▪ NSV flow</li> <li>▪ NSV flow alternative</li> <li>▪ External pressure</li> <li>▪ Exciter current 1</li> <li>▪ Exciter current 2</li> <li>▪ Oscillation frequency 1</li> <li>▪ Oscillation frequency 2</li> <li>▪ S&amp;W volume flow</li> <li>▪ Reference density</li> <li>▪ Reference density alternative</li> <li>▪ Corrected volume flow</li> </ul>	
		<ul style="list-style-type: none"> <li>▪ Oil corrected volume flow</li> <li>▪ Water corrected volume flow</li> <li>▪ Oscillation damping fluctuation 1</li> <li>▪ Oscillation damping fluctuation 2</li> <li>▪ Frequency fluctuation 1</li> <li>▪ Frequency fluctuation 2</li> <li>▪ Target mass flow</li> <li>▪ Carrier volume flow</li> <li>▪ Target volume flow</li> <li>▪ Temp. compensated dynamic viscosity</li> <li>▪ Temp. compensated kinematic viscosity</li> <li>▪ Temperature</li> <li>▪ Status</li> <li>▪ Volume flow</li> <li>▪ Oil volume flow</li> <li>▪ Water volume flow</li> <li>▪ Water cut</li> </ul>	

Diagnostic information		Remedy instructions	
No.	Short text		
374	Sensor electronic (ISEM) faulty	1. Restart device 2. Check if failure recurs 3. Replace sensor electronic module (ISEM)	
	<b>Measured variable status [from the factory] <sup>1)</sup></b>		
	Quality		Bad
	Quality substatus		Maintenance alarm
	Coding (hex)		0x24 to 0x27
	Status signal		S
	Diagnostic behavior		Warning
<b>Influenced measured variables</b>			
<ul style="list-style-type: none"> <li>▪ Oscillation amplitude 1</li> <li>▪ Oscillation amplitude 2</li> <li>▪ Signal asymmetry</li> <li>▪ Carrier mass flow</li> <li>▪ Carrier pipe temperature</li> <li>▪ Concentration</li> <li>▪ Oscillation damping 1</li> <li>▪ Oscillation damping 2</li> <li>▪ Density</li> <li>▪ Dynamic viscosity</li> <li>▪ Sensor electronic temperature (ISEM)</li> </ul>		<ul style="list-style-type: none"> <li>▪ <b>Empty pipe detection</b> option</li> <li>▪ Kinematic viscosity</li> <li>▪ <b>Low flow cut off</b> option</li> <li>▪ Mass flow</li> <li>▪ HBSI</li> <li>▪ External pressure</li> <li>▪ Exciter current 1</li> <li>▪ Exciter current 2</li> <li>▪ Oscillation frequency 1</li> <li>▪ Oscillation frequency 2</li> <li>▪ Reference density</li> </ul>	
		<ul style="list-style-type: none"> <li>▪ Corrected volume flow</li> <li>▪ Oscillation damping fluctuation 1</li> <li>▪ Oscillation damping fluctuation 2</li> <li>▪ Frequency fluctuation 1</li> <li>▪ Frequency fluctuation 2</li> <li>▪ Target mass flow</li> <li>▪ Temp. compensated dynamic viscosity</li> <li>▪ Temp. compensated kinematic viscosity</li> <li>▪ Temperature</li> <li>▪ Status</li> <li>▪ Volume flow</li> </ul>	

1) Diagnostic behavior can be changed. This causes the overall status of the measured variable to change.

Diagnostic information		Remedy instructions	
No.	Short text		
375	I/O- 1 to n communication failed	<ol style="list-style-type: none"> <li>1. Restart device</li> <li>2. Check if failure recurs</li> <li>3. Replace module rack inclusive electronic modules</li> </ol>	
<b>Measured variable status</b>			
Quality	Bad		
Quality substatus	Maintenance alarm		
Coding (hex)	0x24 to 0x27		
Status signal	F		
Diagnostic behavior	Alarm		
<b>Influenced measured variables</b>			
<ul style="list-style-type: none"> <li>▪ Oscillation amplitude 1</li> <li>▪ Oscillation amplitude 2</li> <li>▪ Signal asymmetry</li> <li>▪ Carrier mass flow</li> <li>▪ Carrier pipe temperature</li> <li>▪ Target corrected volume flow</li> <li>▪ Carrier corrected volume flow</li> <li>▪ Concentration</li> <li>▪ Measured values 1</li> <li>▪ Measured values 2</li> <li>▪ Measured values 3</li> <li>▪ Oscillation damping 1</li> <li>▪ Oscillation damping 2</li> <li>▪ Density</li> <li>▪ Oil density</li> <li>▪ Water density</li> <li>▪ Dynamic viscosity</li> <li>▪ Sensor electronic temperature (ISEM)</li> </ul>		<ul style="list-style-type: none"> <li>▪ <b>Empty pipe detection</b> option</li> <li>▪ GSV flow</li> <li>▪ GSV flow alternative</li> <li>▪ Kinematic viscosity</li> <li>▪ <b>Low flow cut off</b> option</li> <li>▪ Mass flow</li> <li>▪ Oil mass flow</li> <li>▪ Water mass flow</li> <li>▪ HBSI</li> <li>▪ NSV flow</li> <li>▪ NSV flow alternative</li> <li>▪ External pressure</li> <li>▪ Exciter current 1</li> <li>▪ Exciter current 2</li> <li>▪ Oscillation frequency 1</li> <li>▪ Oscillation frequency 2</li> <li>▪ S&amp;W volume flow</li> <li>▪ Reference density</li> </ul>	<ul style="list-style-type: none"> <li>▪ Reference density alternative</li> <li>▪ Corrected volume flow</li> <li>▪ Oil corrected volume flow</li> <li>▪ Water corrected volume flow</li> <li>▪ Oscillation damping fluctuation 1</li> <li>▪ Oscillation damping fluctuation 2</li> <li>▪ Frequency fluctuation 1</li> <li>▪ Frequency fluctuation 2</li> <li>▪ Target mass flow</li> <li>▪ Carrier volume flow</li> <li>▪ Target volume flow</li> <li>▪ Temp. compensated dynamic viscosity</li> <li>▪ Temp. compensated kinematic viscosity</li> <li>▪ Temperature</li> <li>▪ Status</li> <li>▪ Volume flow</li> </ul>



Diagnostic information		Remedy instructions	
No.	Short text		
382	Data storage	1. Insert T-DAT 2. Replace T-DAT	
	<b>Measured variable status</b>		
	Quality		Bad
	Quality substatus		Maintenance alarm
	Coding (hex)		0x24 to 0x27
	Status signal		F
	Diagnostic behavior		Alarm
<b>Influenced measured variables</b>			
<ul style="list-style-type: none"> <li>▪ Oscillation amplitude 1</li> <li>▪ Oscillation amplitude 2</li> <li>▪ Signal asymmetry</li> <li>▪ Carrier mass flow</li> <li>▪ Carrier pipe temperature</li> <li>▪ Target corrected volume flow</li> <li>▪ Carrier corrected volume flow</li> <li>▪ Concentration</li> <li>▪ Measured values 1</li> <li>▪ Measured values 2</li> <li>▪ Measured values 3</li> <li>▪ Oscillation damping 1</li> <li>▪ Oscillation damping 2</li> <li>▪ Density</li> <li>▪ Oil density</li> <li>▪ Water density</li> <li>▪ Dynamic viscosity</li> <li>▪ Sensor electronic temperature (ISEM)</li> <li>▪ <b>Empty pipe detection</b> option</li> <li>▪ GSV flow</li> <li>▪ GSV flow alternative</li> <li>▪ Kinematic viscosity</li> <li>▪ <b>Low flow cut off</b> option</li> <li>▪ Mass flow</li> <li>▪ Oil mass flow</li> <li>▪ Water mass flow</li> <li>▪ HBSI</li> <li>▪ NSV flow</li> <li>▪ NSV flow alternative</li> <li>▪ External pressure</li> <li>▪ Exciter current 1</li> <li>▪ Exciter current 2</li> <li>▪ Oscillation frequency 1</li> <li>▪ Oscillation frequency 2</li> <li>▪ S&amp;W volume flow</li> <li>▪ Reference density</li> <li>▪ Reference density alternative</li> <li>▪ Corrected volume flow</li> <li>▪ Oil corrected volume flow</li> <li>▪ Water corrected volume flow</li> <li>▪ Oscillation damping fluctuation 1</li> <li>▪ Oscillation damping fluctuation 2</li> <li>▪ Frequency fluctuation 1</li> <li>▪ Frequency fluctuation 2</li> <li>▪ Target mass flow</li> <li>▪ Carrier volume flow</li> <li>▪ Target volume flow</li> <li>▪ Temp. compensated dynamic viscosity</li> <li>▪ Temp. compensated kinematic viscosity</li> <li>▪ Temperature</li> <li>▪ Status</li> <li>▪ Volume flow</li> <li>▪ Oil volume flow</li> <li>▪ Water volume flow</li> <li>▪ Water cut</li> </ul>			

Diagnostic information		Remedy instructions	
No.	Short text		
383	Memory content	1. Restart device 2. Delete T-DAT via 'Reset device' parameter 3. Replace T-DAT	
	<b>Measured variable status</b>		
	Quality		Bad
	Quality substatus		Maintenance alarm
	Coding (hex)		0x24 to 0x27
	Status signal		F
	Diagnostic behavior		Alarm
<b>Influenced measured variables</b>			
<ul style="list-style-type: none"> <li>▪ Oscillation amplitude 1</li> <li>▪ Oscillation amplitude 2</li> <li>▪ Signal asymmetry</li> <li>▪ Carrier mass flow</li> <li>▪ Carrier pipe temperature</li> <li>▪ Target corrected volume flow</li> <li>▪ Carrier corrected volume flow</li> <li>▪ Concentration</li> <li>▪ Measured values 1</li> <li>▪ Measured values 2</li> <li>▪ Measured values 3</li> <li>▪ Oscillation damping 1</li> <li>▪ Oscillation damping 2</li> <li>▪ Density</li> <li>▪ Oil density</li> <li>▪ Water density</li> <li>▪ Dynamic viscosity</li> <li>▪ Sensor electronic temperature (ISEM)</li> <li>▪ <b>Empty pipe detection</b> option</li> <li>▪ GSV flow</li> <li>▪ GSV flow alternative</li> <li>▪ Kinematic viscosity</li> <li>▪ <b>Low flow cut off</b> option</li> <li>▪ Mass flow</li> <li>▪ Oil mass flow</li> <li>▪ Water mass flow</li> <li>▪ HBSI</li> <li>▪ NSV flow</li> <li>▪ NSV flow alternative</li> <li>▪ External pressure</li> <li>▪ Exciter current 1</li> <li>▪ Exciter current 2</li> <li>▪ Oscillation frequency 1</li> <li>▪ Oscillation frequency 2</li> <li>▪ S&amp;W volume flow</li> <li>▪ Reference density</li> <li>▪ Reference density alternative</li> <li>▪ Corrected volume flow</li> <li>▪ Oil corrected volume flow</li> <li>▪ Water corrected volume flow</li> <li>▪ Oscillation damping fluctuation 1</li> <li>▪ Oscillation damping fluctuation 2</li> <li>▪ Frequency fluctuation 1</li> <li>▪ Frequency fluctuation 2</li> <li>▪ Target mass flow</li> <li>▪ Carrier volume flow</li> <li>▪ Target volume flow</li> <li>▪ Temp. compensated dynamic viscosity</li> <li>▪ Temp. compensated kinematic viscosity</li> <li>▪ Temperature</li> <li>▪ Status</li> <li>▪ Volume flow</li> </ul>			

Diagnostic information		Remedy instructions	
No.	Short text		
387	HistoROM backup failed	Contact service organization	
	<b>Measured variable status</b>		
	Quality		Bad
	Quality substatus		Maintenance alarm
	Coding (hex)		0x24 to 0x27
	Status signal		F
	Diagnostic behavior		Alarm
<b>Influenced measured variables</b>			
<ul style="list-style-type: none"> <li>▪ Oscillation amplitude 1</li> <li>▪ Oscillation amplitude 2</li> <li>▪ Signal asymmetry</li> <li>▪ Carrier mass flow</li> <li>▪ Carrier pipe temperature</li> <li>▪ Target corrected volume flow</li> <li>▪ Carrier corrected volume flow</li> <li>▪ Concentration</li> <li>▪ Measured values 1</li> <li>▪ Measured values 2</li> <li>▪ Measured values 3</li> <li>▪ Oscillation damping 1</li> <li>▪ Oscillation damping 2</li> <li>▪ Density</li> <li>▪ Oil density</li> <li>▪ Water density</li> <li>▪ Dynamic viscosity</li> <li>▪ Sensor electronic temperature (ISEM)</li> <li>▪ <b>Empty pipe detection</b> option</li> <li>▪ GSV flow</li> <li>▪ GSV flow alternative</li> <li>▪ Kinematic viscosity</li> <li>▪ <b>Low flow cut off</b> option</li> <li>▪ Mass flow</li> <li>▪ Oil mass flow</li> <li>▪ Water mass flow</li> <li>▪ HBSI</li> <li>▪ NSV flow</li> <li>▪ NSV flow alternative</li> <li>▪ External pressure</li> <li>▪ Exciter current 1</li> <li>▪ Exciter current 2</li> <li>▪ Oscillation frequency 1</li> <li>▪ Oscillation frequency 2</li> <li>▪ S&amp;W volume flow</li> <li>▪ Reference density</li> <li>▪ Reference density alternative</li> <li>▪ Corrected volume flow</li> <li>▪ Oil corrected volume flow</li> <li>▪ Water corrected volume flow</li> <li>▪ Oscillation damping fluctuation 1</li> <li>▪ Oscillation damping fluctuation 2</li> <li>▪ Frequency fluctuation 1</li> <li>▪ Frequency fluctuation 2</li> <li>▪ Target mass flow</li> <li>▪ Carrier volume flow</li> <li>▪ Target volume flow</li> <li>▪ Temp. compensated dynamic viscosity</li> <li>▪ Temp. compensated kinematic viscosity</li> <li>▪ Temperature</li> <li>▪ Status</li> <li>▪ Volume flow</li> <li>▪ Oil volume flow</li> <li>▪ Water volume flow</li> <li>▪ Water cut</li> </ul>			

### 12.7.3 Diagnostic of configuration

Diagnostic information		Remedy instructions	
No.	Short text		
330	Flash file invalid	<ol style="list-style-type: none"> <li>1. Update firmware of device</li> <li>2. Restart device</li> </ol>	
	<b>Measured variable status</b>		
	Quality		Bad
	Quality substatus		Maintenance alarm
	Coding (hex)		0x24 to 0x27
	Status signal		M
	Diagnostic behavior		Warning
<b>Influenced measured variables</b>			
<ul style="list-style-type: none"> <li>▪ Oscillation amplitude 1</li> <li>▪ Oscillation amplitude 2</li> <li>▪ Signal asymmetry</li> <li>▪ Carrier mass flow</li> <li>▪ Carrier pipe temperature</li> <li>▪ Concentration</li> <li>▪ Measured values 1</li> <li>▪ Measured values 2</li> <li>▪ Measured values 3</li> <li>▪ Oscillation damping 1</li> <li>▪ Oscillation damping 2</li> <li>▪ Density</li> <li>▪ Dynamic viscosity</li> <li>▪ Sensor electronic temperature (ISEM)</li> <li>▪ <b>Empty pipe detection</b> option</li> <li>▪ Kinematic viscosity</li> <li>▪ <b>Low flow cut off</b> option</li> <li>▪ Mass flow</li> <li>▪ HBSI</li> <li>▪ External pressure</li> <li>▪ Exciter current 1</li> <li>▪ Exciter current 2</li> <li>▪ Oscillation frequency 1</li> <li>▪ Oscillation frequency 2</li> <li>▪ Reference density</li> <li>▪ Corrected volume flow</li> <li>▪ Oscillation damping fluctuation 1</li> <li>▪ Oscillation damping fluctuation 2</li> <li>▪ Frequency fluctuation 1</li> <li>▪ Frequency fluctuation 2</li> <li>▪ Target mass flow</li> <li>▪ Temp. compensated dynamic viscosity</li> <li>▪ Temp. compensated kinematic viscosity</li> <li>▪ Temperature</li> <li>▪ Status</li> <li>▪ Volume flow</li> </ul>			

Diagnostic information		Remedy instructions
No.	Short text	
331	Firmware update failed	1. Update firmware of device 2. Restart device
<b>Measured variable status</b>		
Quality	Bad	
Quality substatus	Maintenance alarm	
Coding (hex)	0x24 to 0x27	
Status signal	F	
Diagnostic behavior	Warning	
<b>Influenced measured variables</b>		
<ul style="list-style-type: none"> <li>▪ Oscillation amplitude 1</li> <li>▪ Oscillation amplitude 2</li> <li>▪ Signal asymmetry</li> <li>▪ Carrier mass flow</li> <li>▪ Carrier pipe temperature</li> <li>▪ Target corrected volume flow</li> <li>▪ Carrier corrected volume flow</li> <li>▪ Concentration</li> <li>▪ Measured values 1</li> <li>▪ Measured values 2</li> <li>▪ Measured values 3</li> <li>▪ Oscillation damping 1</li> <li>▪ Oscillation damping 2</li> <li>▪ Density</li> <li>▪ Oil density</li> <li>▪ Water density</li> <li>▪ Dynamic viscosity</li> <li>▪ Sensor electronic temperature (ISEM)</li> <li>▪ <b>Empty pipe detection</b> option</li> </ul>		<ul style="list-style-type: none"> <li>▪ GSV flow</li> <li>▪ GSV flow alternative</li> <li>▪ Kinematic viscosity</li> <li>▪ <b>Low flow cut off</b> option</li> <li>▪ Mass flow</li> <li>▪ Oil mass flow</li> <li>▪ Water mass flow</li> <li>▪ HBSI</li> <li>▪ NSV flow</li> <li>▪ NSV flow alternative</li> <li>▪ External pressure</li> <li>▪ Exciter current 1</li> <li>▪ Exciter current 2</li> <li>▪ Oscillation frequency 1</li> <li>▪ Oscillation frequency 2</li> <li>▪ S&amp;W volume flow</li> <li>▪ Reference density</li> <li>▪ Reference density alternative</li> <li>▪ Corrected volume flow</li> </ul>
		<ul style="list-style-type: none"> <li>▪ Oil corrected volume flow</li> <li>▪ Water corrected volume flow</li> <li>▪ Oscillation damping fluctuation 1</li> <li>▪ Oscillation damping fluctuation 2</li> <li>▪ Frequency fluctuation 1</li> <li>▪ Frequency fluctuation 2</li> <li>▪ Target mass flow</li> <li>▪ Carrier volume flow</li> <li>▪ Target volume flow</li> <li>▪ Temp. compensated dynamic viscosity</li> <li>▪ Temp. compensated kinematic viscosity</li> <li>▪ Temperature</li> <li>▪ Status</li> <li>▪ Volume flow</li> <li>▪ Oil volume flow</li> <li>▪ Water volume flow</li> <li>▪ Water cut</li> </ul>

Diagnostic information		Remedy instructions	
No.	Short text		
410	Data transfer	1. Check connection 2. Retry data transfer	
	<b>Measured variable status</b>		
	Quality		Bad
	Quality substatus		Maintenance alarm
	Coding (hex)		0x24 to 0x27
	Status signal		F
	Diagnostic behavior		Alarm
<b>Influenced measured variables</b>			
<ul style="list-style-type: none"> <li>▪ Oscillation amplitude 1</li> <li>▪ Oscillation amplitude 2</li> <li>▪ Signal asymmetry</li> <li>▪ Carrier mass flow</li> <li>▪ Carrier pipe temperature</li> <li>▪ Target corrected volume flow</li> <li>▪ Carrier corrected volume flow</li> <li>▪ Concentration</li> <li>▪ Measured values 1</li> <li>▪ Measured values 2</li> <li>▪ Measured values 3</li> <li>▪ Oscillation damping 1</li> <li>▪ Oscillation damping 2</li> <li>▪ Density</li> <li>▪ Oil density</li> <li>▪ Water density</li> <li>▪ Dynamic viscosity</li> <li>▪ Sensor electronic temperature (ISEM)</li> <li>▪ <b>Empty pipe detection</b> option</li> <li>▪ GSV flow</li> <li>▪ GSV flow alternative</li> <li>▪ Kinematic viscosity</li> <li>▪ <b>Low flow cut off</b> option</li> <li>▪ Mass flow</li> <li>▪ Oil mass flow</li> <li>▪ Water mass flow</li> <li>▪ HBSI</li> <li>▪ NSV flow</li> <li>▪ NSV flow alternative</li> <li>▪ External pressure</li> <li>▪ Exciter current 1</li> <li>▪ Exciter current 2</li> <li>▪ Oscillation frequency 1</li> <li>▪ Oscillation frequency 2</li> <li>▪ S&amp;W volume flow</li> <li>▪ Reference density</li> <li>▪ Reference density alternative</li> <li>▪ Corrected volume flow</li> <li>▪ Oil corrected volume flow</li> <li>▪ Water corrected volume flow</li> <li>▪ Oscillation damping fluctuation 1</li> <li>▪ Oscillation damping fluctuation 2</li> <li>▪ Frequency fluctuation 1</li> <li>▪ Frequency fluctuation 2</li> <li>▪ Target mass flow</li> <li>▪ Carrier volume flow</li> <li>▪ Target volume flow</li> <li>▪ Temp. compensated dynamic viscosity</li> <li>▪ Temp. compensated kinematic viscosity</li> <li>▪ Temperature</li> <li>▪ Status</li> <li>▪ Volume flow</li> <li>▪ Oil volume flow</li> <li>▪ Water volume flow</li> <li>▪ Water cut</li> </ul>			

Diagnostic information		Remedy instructions	
No.	Short text		
412	Processing download	Download active, please wait	
	<b>Measured variable status</b>		
	Quality		Uncertain
	Quality substatus		Initial value
	Coding (hex)		0x4C to 0x4F
	Status signal		C
	Diagnostic behavior		Warning
	<b>Influenced measured variables</b>		
<ul style="list-style-type: none"> <li>▪ Oscillation amplitude 1</li> <li>▪ Oscillation amplitude 2</li> <li>▪ Signal asymmetry</li> <li>▪ Carrier mass flow</li> <li>▪ Carrier pipe temperature</li> <li>▪ Target corrected volume flow</li> <li>▪ Carrier corrected volume flow</li> <li>▪ Concentration</li> <li>▪ Measured values 1</li> <li>▪ Measured values 2</li> <li>▪ Measured values 3</li> <li>▪ Oscillation damping 1</li> <li>▪ Oscillation damping 2</li> <li>▪ Density</li> <li>▪ Oil density</li> <li>▪ Water density</li> <li>▪ Dynamic viscosity</li> <li>▪ Sensor electronic temperature (ISEM)</li> <li>▪ <b>Empty pipe detection</b> option</li> <li>▪ GSV flow</li> <li>▪ GSV flow alternative</li> <li>▪ Kinematic viscosity</li> <li>▪ <b>Low flow cut off</b> option</li> <li>▪ Mass flow</li> <li>▪ Oil mass flow</li> <li>▪ Water mass flow</li> <li>▪ HBSI</li> <li>▪ NSV flow</li> <li>▪ NSV flow alternative</li> <li>▪ External pressure</li> <li>▪ Exciter current 1</li> <li>▪ Exciter current 2</li> <li>▪ Oscillation frequency 1</li> <li>▪ Oscillation frequency 2</li> <li>▪ S&amp;W volume flow</li> <li>▪ Reference density</li> <li>▪ Reference density alternative</li> <li>▪ Corrected volume flow</li> <li>▪ Oil corrected volume flow</li> <li>▪ Water corrected volume flow</li> <li>▪ Oscillation damping fluctuation 1</li> <li>▪ Oscillation damping fluctuation 2</li> <li>▪ Frequency fluctuation 1</li> <li>▪ Frequency fluctuation 2</li> <li>▪ Target mass flow</li> <li>▪ Carrier volume flow</li> <li>▪ Target volume flow</li> <li>▪ Temp. compensated dynamic viscosity</li> <li>▪ Temp. compensated kinematic viscosity</li> <li>▪ Temperature</li> <li>▪ Status</li> <li>▪ Volume flow</li> <li>▪ Oil volume flow</li> <li>▪ Water volume flow</li> <li>▪ Water cut</li> </ul>			

Diagnostic information		Remedy instructions	
No.	Short text		
431	Trim 1 to n	Carry out trim	
	<b>Measured variable status</b>		
	Quality		Good
	Quality substatus		Function check
	Coding (hex)		0xBC to 0xBF
	Status signal		C
	Diagnostic behavior		Warning
	<b>Influenced measured variables</b>		
-			

Diagnostic information		Remedy instructions	
No.	Short text		
437	Configuration incompatible	1. Restart device 2. Contact service	
	<b>Measured variable status</b>		
	Quality		Bad
	Quality substatus		Maintenance alarm
	Coding (hex)		0x24 to 0x27
	Status signal		F
	Diagnostic behavior		Alarm
<b>Influenced measured variables</b>			
<ul style="list-style-type: none"> <li>▪ Oscillation amplitude 1</li> <li>▪ Oscillation amplitude 2</li> <li>▪ Signal asymmetry</li> <li>▪ Carrier mass flow</li> <li>▪ Carrier pipe temperature</li> <li>▪ Target corrected volume flow</li> <li>▪ Carrier corrected volume flow</li> <li>▪ Concentration</li> <li>▪ Measured values 1</li> <li>▪ Measured values 2</li> <li>▪ Measured values 3</li> <li>▪ Oscillation damping 1</li> <li>▪ Oscillation damping 2</li> <li>▪ Density</li> <li>▪ Oil density</li> <li>▪ Water density</li> <li>▪ Dynamic viscosity</li> <li>▪ Sensor electronic temperature (ISEM)</li> <li>▪ <b>Empty pipe detection</b> option</li> <li>▪ GSV flow</li> <li>▪ GSV flow alternative</li> <li>▪ Kinematic viscosity</li> <li>▪ <b>Low flow cut off</b> option</li> <li>▪ Mass flow</li> <li>▪ Oil mass flow</li> <li>▪ Water mass flow</li> <li>▪ HBSI</li> <li>▪ NSV flow</li> <li>▪ NSV flow alternative</li> <li>▪ External pressure</li> <li>▪ Exciter current 1</li> <li>▪ Exciter current 2</li> <li>▪ Oscillation frequency 1</li> <li>▪ Oscillation frequency 2</li> <li>▪ S&amp;W volume flow</li> <li>▪ Reference density</li> <li>▪ Reference density alternative</li> <li>▪ Corrected volume flow</li> <li>▪ Oil corrected volume flow</li> <li>▪ Water corrected volume flow</li> <li>▪ Oscillation damping fluctuation 1</li> <li>▪ Oscillation damping fluctuation 2</li> <li>▪ Frequency fluctuation 1</li> <li>▪ Frequency fluctuation 2</li> <li>▪ Target mass flow</li> <li>▪ Carrier volume flow</li> <li>▪ Target volume flow</li> <li>▪ Temp. compensated dynamic viscosity</li> <li>▪ Temp. compensated kinematic viscosity</li> <li>▪ Temperature</li> <li>▪ Status</li> <li>▪ Volume flow</li> <li>▪ Oil volume flow</li> <li>▪ Water volume flow</li> <li>▪ Water cut</li> </ul>			

Diagnostic information		Remedy instructions	
No.	Short text		
438	Dataset	1. Check data set file 2. Check device configuration 3. Up- and download new configuration	
	<b>Measured variable status</b>		
	Quality		Uncertain
	Quality substatus		Maintenance demanded
	Coding (hex)		0x68 to 0x6B
	Status signal		M
	Diagnostic behavior		Warning
	<b>Influenced measured variables</b>		
<ul style="list-style-type: none"> <li>▪ Oscillation amplitude 1</li> <li>▪ Oscillation amplitude 2</li> <li>▪ Signal asymmetry</li> <li>▪ Carrier mass flow</li> <li>▪ Carrier pipe temperature</li> <li>▪ Target corrected volume flow</li> <li>▪ Carrier corrected volume flow</li> <li>▪ Concentration</li> <li>▪ Measured values 1</li> <li>▪ Measured values 2</li> <li>▪ Measured values 3</li> <li>▪ Oscillation damping 1</li> <li>▪ Oscillation damping 2</li> <li>▪ Density</li> <li>▪ Oil density</li> <li>▪ Water density</li> <li>▪ Dynamic viscosity</li> <li>▪ Sensor electronic temperature (ISEM)</li> <li>▪ <b>Empty pipe detection</b> option</li> <li>▪ GSV flow</li> <li>▪ GSV flow alternative</li> <li>▪ Kinematic viscosity</li> <li>▪ <b>Low flow cut off</b> option</li> <li>▪ Mass flow</li> <li>▪ Oil mass flow</li> <li>▪ Water mass flow</li> <li>▪ HBSI</li> <li>▪ NSV flow</li> <li>▪ NSV flow alternative</li> <li>▪ External pressure</li> <li>▪ Exciter current 1</li> <li>▪ Exciter current 2</li> <li>▪ Oscillation frequency 1</li> <li>▪ Oscillation frequency 2</li> <li>▪ S&amp;W volume flow</li> <li>▪ Reference density</li> <li>▪ Reference density alternative</li> <li>▪ Corrected volume flow</li> <li>▪ Oil corrected volume flow</li> <li>▪ Water corrected volume flow</li> <li>▪ Oscillation damping fluctuation 1</li> <li>▪ Oscillation damping fluctuation 2</li> <li>▪ Frequency fluctuation 1</li> <li>▪ Frequency fluctuation 2</li> <li>▪ Target mass flow</li> <li>▪ Carrier volume flow</li> <li>▪ Target volume flow</li> <li>▪ Temp. compensated dynamic viscosity</li> <li>▪ Temp. compensated kinematic viscosity</li> <li>▪ Temperature</li> <li>▪ Status</li> <li>▪ Volume flow</li> <li>▪ Oil volume flow</li> <li>▪ Water volume flow</li> <li>▪ Water cut</li> </ul>			

Diagnostic information		Remedy instructions	
No.	Short text		
441	Current output 1 to n	1. Check process 2. Check current output settings	
	<b>Measured variable status [from the factory] <sup>1)</sup></b>		
	Quality		Good
	Quality substatus		Function check
	Coding (hex)		0xBC to 0xBF
	Status signal		S
	Diagnostic behavior		Warning
	<b>Influenced measured variables</b>		
-			

1) Diagnostic behavior can be changed. This causes the overall status of the measured variable to change.



Diagnostic information		Remedy instructions	
No.	Short text		
442	Frequency output 1 to n	1. Check process 2. Check frequency output settings	
	<b>Measured variable status [from the factory] <sup>1)</sup></b>		
	Quality		Good
	Quality substatus		Function check
	Coding (hex)		0xBC to 0xBF
	Status signal		S
	Diagnostic behavior		Warning
	<b>Influenced measured variables</b>		
-			

1) Diagnostic behavior can be changed. This causes the overall status of the measured variable to change.

Diagnostic information		Remedy instructions	
No.	Short text		
443	Pulse output 1 to n	1. Check process 2. Check pulse output settings	
	<b>Measured variable status [from the factory] <sup>1)</sup></b>		
	Quality		Good
	Quality substatus		Function check
	Coding (hex)		0xBC to 0xBF
	Status signal		S
	Diagnostic behavior		Warning
	<b>Influenced measured variables</b>		
-			

1) Diagnostic behavior can be changed. This causes the overall status of the measured variable to change.

Diagnostic information		Remedy instructions	
No.	Short text		
444	Current input 1 to n	1. Check process 2. Check current input settings	
	<b>Measured variable status [from the factory] <sup>1)</sup></b>		
	Quality		Good
	Quality substatus		Function check
	Coding (hex)		0xBC to 0xBF
	Status signal		S
	Diagnostic behavior		Warning
	<b>Influenced measured variables</b>		
<ul style="list-style-type: none"> <li>■ Measured values 1</li> <li>■ Measured values 2</li> <li>■ Measured values 3</li> </ul>			

1) Diagnostic behavior can be changed. This causes the overall status of the measured variable to change.

Diagnostic information		Remedy instructions	
No.	Short text		
453	Flow override	Deactivate flow override	
	<b>Measured variable status</b>		
	Quality		Good
	Quality substatus		Function check
	Coding (hex)		0xBC to 0xBF
	Status signal		C
	Diagnostic behavior		Warning
<b>Influenced measured variables</b>			
<ul style="list-style-type: none"> <li>▪ Oscillation amplitude 1</li> <li>▪ Oscillation amplitude 2</li> <li>▪ Signal asymmetry</li> <li>▪ Carrier mass flow</li> <li>▪ Carrier pipe temperature</li> <li>▪ Target corrected volume flow</li> <li>▪ Carrier corrected volume flow</li> <li>▪ Concentration</li> <li>▪ Oscillation damping 1</li> <li>▪ Oscillation damping 2</li> <li>▪ Density</li> <li>▪ Oil density</li> <li>▪ Water density</li> <li>▪ Dynamic viscosity</li> <li>▪ Sensor electronic temperature (ISEM)</li> <li>▪ <b>Empty pipe detection</b> option</li> <li>▪ GSV flow</li> <li>▪ GSV flow alternative</li> </ul>		<ul style="list-style-type: none"> <li>▪ Kinematic viscosity</li> <li>▪ <b>Low flow cut off</b> option</li> <li>▪ Mass flow</li> <li>▪ Oil mass flow</li> <li>▪ Water mass flow</li> <li>▪ HBSI</li> <li>▪ NSV flow</li> <li>▪ NSV flow alternative</li> <li>▪ External pressure</li> <li>▪ Exciter current 1</li> <li>▪ Exciter current 2</li> <li>▪ Oscillation frequency 1</li> <li>▪ Oscillation frequency 2</li> <li>▪ S&amp;W volume flow</li> <li>▪ Reference density</li> <li>▪ Reference density alternative</li> <li>▪ Corrected volume flow</li> <li>▪ Oil corrected volume flow</li> </ul>	
<ul style="list-style-type: none"> <li>▪ Water corrected volume flow</li> <li>▪ Oscillation damping fluctuation 1</li> <li>▪ Oscillation damping fluctuation 2</li> <li>▪ Frequency fluctuation 1</li> <li>▪ Frequency fluctuation 2</li> <li>▪ Target mass flow</li> <li>▪ Carrier volume flow</li> <li>▪ Target volume flow</li> <li>▪ Temp. compensated dynamic viscosity</li> <li>▪ Temp. compensated kinematic viscosity</li> <li>▪ Temperature</li> <li>▪ Status</li> <li>▪ Volume flow</li> <li>▪ Oil volume flow</li> <li>▪ Water volume flow</li> <li>▪ Water cut</li> </ul>			

Diagnostic information		Remedy instructions	
No.	Short text		
463	Analog input 1 to n selection invalid	1. Check module/channel configuration 2. Check I/O module configuration	
	<b>Measured variable status</b>		
	Quality		Bad
	Quality substatus		Maintenance alarm
	Coding (hex)		0x24 to 0x27
	Status signal		F
	Diagnostic behavior		Alarm
<b>Influenced measured variables</b>			
<ul style="list-style-type: none"> <li>▪ Measured values 1</li> <li>▪ Measured values 2</li> <li>▪ Measured values 3</li> </ul>			

Diagnostic information		Remedy instructions	
No.	Short text		
482	FB not Auto/Cas	Set Block in AUTO mode	
	<b>Measured variable status</b>		
	Quality		Good
	Quality substatus		Ok
	Coding (hex)		0x80 to 0x83
	Status signal		F
	Diagnostic behavior		Alarm
	<b>Influenced measured variables</b>		
-			

Diagnostic information		Remedy instructions	
No.	Short text		
484	Failure mode simulation	Deactivate simulation	
	<b>Measured variable status</b>		
	Quality		Bad
	Quality substatus		Function check
	Coding (hex)		0x3C to 0x3F
	Status signal		C
	Diagnostic behavior		Alarm
	<b>Influenced measured variables</b>		
<ul style="list-style-type: none"> <li>▪ Oscillation amplitude 1</li> <li>▪ Oscillation amplitude 2</li> <li>▪ Signal asymmetry</li> <li>▪ Carrier mass flow</li> <li>▪ Carrier pipe temperature</li> <li>▪ Target corrected volume flow</li> <li>▪ Carrier corrected volume flow</li> <li>▪ Concentration</li> <li>▪ Oscillation damping 1</li> <li>▪ Oscillation damping 2</li> <li>▪ Density</li> <li>▪ Oil density</li> <li>▪ Water density</li> <li>▪ Dynamic viscosity</li> <li>▪ Sensor electronic temperature (ISEM)</li> <li>▪ <b>Empty pipe detection</b> option</li> <li>▪ GSV flow</li> <li>▪ GSV flow alternative</li> </ul>		<ul style="list-style-type: none"> <li>▪ Kinematic viscosity</li> <li>▪ <b>Low flow cut off</b> option</li> <li>▪ Mass flow</li> <li>▪ Oil mass flow</li> <li>▪ Water mass flow</li> <li>▪ HBSI</li> <li>▪ NSV flow</li> <li>▪ NSV flow alternative</li> <li>▪ External pressure</li> <li>▪ Exciter current 1</li> <li>▪ Exciter current 2</li> <li>▪ Oscillation frequency 1</li> <li>▪ Oscillation frequency 2</li> <li>▪ S&amp;W volume flow</li> <li>▪ Reference density</li> <li>▪ Reference density alternative</li> <li>▪ Corrected volume flow</li> <li>▪ Oil corrected volume flow</li> </ul>	<ul style="list-style-type: none"> <li>▪ Water corrected volume flow</li> <li>▪ Oscillation damping fluctuation 1</li> <li>▪ Oscillation damping fluctuation 2</li> <li>▪ Frequency fluctuation 1</li> <li>▪ Frequency fluctuation 2</li> <li>▪ Target mass flow</li> <li>▪ Carrier volume flow</li> <li>▪ Target volume flow</li> <li>▪ Temp. compensated dynamic viscosity</li> <li>▪ Temp. compensated kinematic viscosity</li> <li>▪ Temperature</li> <li>▪ Status</li> <li>▪ Volume flow</li> <li>▪ Oil volume flow</li> <li>▪ Water volume flow</li> <li>▪ Water cut</li> </ul>

Diagnostic information		Remedy instructions	
No.	Short text		
485	Measured variable simulation	Deactivate simulation	
	<b>Measured variable status</b>		
	Quality		Good
	Quality substatus		Function check
	Coding (hex)		0xBC to 0xBF
	Status signal		C
	Diagnostic behavior		Warning
<b>Influenced measured variables</b>			
<ul style="list-style-type: none"> <li>▪ Oscillation amplitude 1</li> <li>▪ Oscillation amplitude 2</li> <li>▪ Signal asymmetry</li> <li>▪ Carrier mass flow</li> <li>▪ Carrier pipe temperature</li> <li>▪ Target corrected volume flow</li> <li>▪ Carrier corrected volume flow</li> <li>▪ Concentration</li> <li>▪ Oscillation damping 1</li> <li>▪ Oscillation damping 2</li> <li>▪ Density</li> <li>▪ Oil density</li> <li>▪ Water density</li> <li>▪ Dynamic viscosity</li> <li>▪ Sensor electronic temperature (ISEM)</li> <li>▪ <b>Empty pipe detection</b> option</li> <li>▪ GSV flow</li> <li>▪ GSV flow alternative</li> <li>▪ Kinematic viscosity</li> <li>▪ <b>Low flow cut off</b> option</li> <li>▪ Mass flow</li> <li>▪ Oil mass flow</li> <li>▪ Water mass flow</li> <li>▪ HBSI</li> <li>▪ NSV flow</li> <li>▪ NSV flow alternative</li> <li>▪ External pressure</li> <li>▪ Exciter current 1</li> <li>▪ Exciter current 2</li> <li>▪ Oscillation frequency 1</li> <li>▪ Oscillation frequency 2</li> <li>▪ S&amp;W volume flow</li> <li>▪ Reference density</li> <li>▪ Reference density alternative</li> <li>▪ Corrected volume flow</li> <li>▪ Oil corrected volume flow</li> <li>▪ Water corrected volume flow</li> <li>▪ Oscillation damping fluctuation 1</li> <li>▪ Oscillation damping fluctuation 2</li> <li>▪ Frequency fluctuation 1</li> <li>▪ Frequency fluctuation 2</li> <li>▪ Target mass flow</li> <li>▪ Carrier volume flow</li> <li>▪ Target volume flow</li> <li>▪ Temp. compensated dynamic viscosity</li> <li>▪ Temp. compensated kinematic viscosity</li> <li>▪ Temperature</li> <li>▪ Status</li> <li>▪ Volume flow</li> <li>▪ Oil volume flow</li> <li>▪ Water volume flow</li> <li>▪ Water cut</li> </ul>			

Diagnostic information		Remedy instructions	
No.	Short text		
486	Current input 1 to n simulation	Deactivate simulation	
	<b>Measured variable status</b>		
	Quality		Good
	Quality substatus		Function check
	Coding (hex)		0xBC to 0xBF
	Status signal		C
	Diagnostic behavior		Warning
<b>Influenced measured variables</b>			
<ul style="list-style-type: none"> <li>▪ Measured values 1</li> <li>▪ Measured values 2</li> <li>▪ Measured values 3</li> </ul>			

Diagnostic information		Remedy instructions	
No.	Short text		
491	Current output 1 to n simulation	Deactivate simulation	
	<b>Measured variable status</b>		
	Quality		Good
	Quality substatus		Function check
	Coding (hex)		0xBC to 0xBF
	Status signal		C
	Diagnostic behavior		Warning
	<b>Influenced measured variables</b>		
-			

Diagnostic information		Remedy instructions	
No.	Short text		
492	Simulation frequency output 1 to n	Deactivate simulation frequency output	
	<b>Measured variable status</b>		
	Quality		Good
	Quality substatus		Function check
	Coding (hex)		0xBC to 0xBF
	Status signal		C
	Diagnostic behavior		Warning
	<b>Influenced measured variables</b>		
-			

Diagnostic information		Remedy instructions	
No.	Short text		
493	Simulation pulse output 1 to n	Deactivate simulation pulse output	
	<b>Measured variable status</b>		
	Quality		Good
	Quality substatus		Function check
	Coding (hex)		0xBC to 0xBF
	Status signal		C
	Diagnostic behavior		Warning
	<b>Influenced measured variables</b>		
-			

Diagnostic information		Remedy instructions	
No.	Short text		
494	Switch output simulation 1 to n	Deactivate simulation switch output	
	<b>Measured variable status</b>		
	Quality		Good
	Quality substatus		Function check
	Coding (hex)		0xBC to 0xBF
	Status signal		C
	Diagnostic behavior		Warning
	<b>Influenced measured variables</b>		
-			

Diagnostic information		Remedy instructions	
No.	Short text		
495	Diagnostic event simulation	Deactivate simulation	
	<b>Measured variable status</b>		
	Quality		Good
	Quality substatus		Ok
	Coding (hex)		0x80 to 0x83
	Status signal		C
	Diagnostic behavior		Warning
	<b>Influenced measured variables</b>		
-			

Diagnostic information		Remedy instructions	
No.	Short text		
496	Status input simulation	Deactivate simulation status input	
	<b>Measured variable status</b>		
	Quality		Good
	Quality substatus		Function check
	Coding (hex)		0xBC to 0xBF
	Status signal		C
	Diagnostic behavior		Warning
	<b>Influenced measured variables</b>		
-			

Diagnostic information		Remedy instructions	
No.	Short text		
497	Simulation block output	Deactivate simulation	
	<b>Measured variable status</b>		
	Quality		Good
	Quality substatus		Ok
	Coding (hex)		0x80 to 0x83
	Status signal		C
	Diagnostic behavior		Warning
	<b>Influenced measured variables</b>		
-			

Diagnostic information		Remedy instructions	
No.	Short text		
520	I/O 1 to n hardware configuration invalid	1. Check I/O hardware configuration 2. Replace wrong I/O module 3. Plug the module of double pulse output on correct slot	
	<b>Measured variable status</b>		
	Quality		Bad
	Quality substatus		Function check
	Coding (hex)		0x3C to 0x3F
	Status signal		F
	Diagnostic behavior		Alarm
	<b>Influenced measured variables</b>		
-			

Diagnostic information		Remedy instructions	
No.	Short text		
528	Concentration settings faulty	1. Check concentration settings 2. Check input values e.g. pressure, temperature	
	<b>Measured variable status</b>		
	Quality		Bad
	Quality substatus		Function check
	Coding (hex)		0x3C to 0x3F
	Status signal		S
	Diagnostic behavior		Alarm
	<b>Influenced measured variables</b>		
<ul style="list-style-type: none"> <li>▪ Carrier mass flow</li> <li>▪ Target corrected volume flow</li> <li>▪ Carrier corrected volume flow</li> <li>▪ Concentration</li> <li>▪ Density</li> <li>▪ Mass flow</li> <li>▪ Target mass flow</li> <li>▪ Carrier volume flow</li> <li>▪ Target volume flow</li> <li>▪ Volume flow</li> </ul>			

Diagnostic information		Remedy instructions	
No.	Short text		
529	Concentration settings faulty	1. Check concentration settings 2. Check input values e.g. pressure, temperature	
	<b>Measured variable status</b>		
	Quality		Bad
	Quality substatus		Function check
	Coding (hex)		0x3C to 0x3F
	Status signal		S
	Diagnostic behavior		Warning
	<b>Influenced measured variables</b>		
<ul style="list-style-type: none"> <li>▪ Carrier mass flow</li> <li>▪ Target corrected volume flow</li> <li>▪ Carrier corrected volume flow</li> <li>▪ Concentration</li> <li>▪ Density</li> <li>▪ Mass flow</li> <li>▪ Target mass flow</li> <li>▪ Carrier volume flow</li> <li>▪ Target volume flow</li> <li>▪ Volume flow</li> </ul>			

Diagnostic information		Remedy instructions	
No.	Short text		
537	Configuration	1. Check IP addresses in network 2. Change IP address	
	<b>Measured variable status</b>		
	Quality		Good
	Quality substatus		Function check
	Coding (hex)		0xBC to 0xBF
	Status signal		F
	Diagnostic behavior		Warning
	<b>Influenced measured variables</b>		
-			

Diagnostic information		Remedy instructions	
No.	Short text		
594	Relay output simulation	Deactivate simulation switch output	
	<b>Measured variable status</b>		
	Quality		Good
	Quality substatus		Function check
	Coding (hex)		0xBC to 0xBF
	Status signal		C
	Diagnostic behavior		Warning
	<b>Influenced measured variables</b>		
-			



### 12.7.4 Diagnostic of process

Diagnostic information		Remedy instructions	
No.	Short text		
803	Current loop	1. Check wiring 2. Change I/O module	
	<b>Measured variable status</b>		
	Quality		Bad
	Quality substatus		Process related
	Coding (hex)		0x28 to 0x2B
	Status signal		F
	Diagnostic behavior		Alarm
	<b>Influenced measured variables</b>		
-			

Diagnostic information		Remedy instructions	
No.	Short text		
830	Sensor temperature too high	Reduce ambient temp. around the sensor housing	
	<b>Measured variable status [from the factory] <sup>1)</sup></b>		
	Quality		Uncertain
	Quality substatus		Process related
	Coding (hex)		0x78 to 0x7B
	Status signal		S
	Diagnostic behavior		Warning
	<b>Influenced measured variables</b>		
<ul style="list-style-type: none"> <li>▪ Oscillation amplitude 1</li> <li>▪ Oscillation amplitude 2</li> <li>▪ Signal asymmetry</li> <li>▪ Carrier mass flow</li> <li>▪ Carrier pipe temperature</li> <li>▪ Target corrected volume flow</li> <li>▪ Carrier corrected volume flow</li> <li>▪ Concentration</li> <li>▪ Oscillation damping 1</li> <li>▪ Oscillation damping 2</li> <li>▪ Density</li> <li>▪ Oil density</li> <li>▪ Water density</li> <li>▪ Dynamic viscosity</li> <li>▪ Sensor electronic temperature (ISEM)</li> <li>▪ <b>Empty pipe detection</b> option</li> <li>▪ GSV flow</li> <li>▪ GSV flow alternative</li> <li>▪ Kinematic viscosity</li> <li>▪ <b>Low flow cut off</b> option</li> <li>▪ Mass flow</li> <li>▪ Oil mass flow</li> <li>▪ Water mass flow</li> <li>▪ HBSI</li> <li>▪ NSV flow</li> <li>▪ NSV flow alternative</li> <li>▪ External pressure</li> <li>▪ Exciter current 1</li> <li>▪ Exciter current 2</li> <li>▪ Oscillation frequency 1</li> <li>▪ Oscillation frequency 2</li> <li>▪ S&amp;W volume flow</li> <li>▪ Reference density</li> <li>▪ Reference density alternative</li> <li>▪ Corrected volume flow</li> <li>▪ Oil corrected volume flow</li> <li>▪ Water corrected volume flow</li> <li>▪ Oscillation damping fluctuation 1</li> <li>▪ Oscillation damping fluctuation 2</li> <li>▪ Frequency fluctuation 1</li> <li>▪ Frequency fluctuation 2</li> <li>▪ Target mass flow</li> <li>▪ Carrier volume flow</li> <li>▪ Target volume flow</li> <li>▪ Temp. compensated dynamic viscosity</li> <li>▪ Temp. compensated kinematic viscosity</li> <li>▪ Temperature</li> <li>▪ Status</li> <li>▪ Volume flow</li> <li>▪ Oil volume flow</li> <li>▪ Water volume flow</li> <li>▪ Water cut</li> </ul>			

1) Diagnostic behavior can be changed. This causes the overall status of the measured variable to change.

Diagnostic information		Remedy instructions
No.	Short text	
831	Sensor temperature too low	Increase ambient temp. around the sensor housing
<b>Measured variable status [from the factory] <sup>1)</sup></b>		
Quality	Uncertain	
Quality substatus	Process related	
Coding (hex)	0x78 to 0x7B	
Status signal	S	
Diagnostic behavior	Warning	
<b>Influenced measured variables</b>		
<ul style="list-style-type: none"> <li>▪ Oscillation amplitude 1</li> <li>▪ Oscillation amplitude 2</li> <li>▪ Signal asymmetry</li> <li>▪ Carrier mass flow</li> <li>▪ Carrier pipe temperature</li> <li>▪ Target corrected volume flow</li> <li>▪ Carrier corrected volume flow</li> <li>▪ Concentration</li> <li>▪ Oscillation damping 1</li> <li>▪ Oscillation damping 2</li> <li>▪ Density</li> <li>▪ Oil density</li> <li>▪ Water density</li> <li>▪ Dynamic viscosity</li> <li>▪ Sensor electronic temperature (ISEM)</li> <li>▪ <b>Empty pipe detection</b> option</li> <li>▪ GSV flow</li> <li>▪ GSV flow alternative</li> </ul>		<ul style="list-style-type: none"> <li>▪ Kinematic viscosity</li> <li>▪ <b>Low flow cut off</b> option</li> <li>▪ Mass flow</li> <li>▪ Oil mass flow</li> <li>▪ Water mass flow</li> <li>▪ HBSI</li> <li>▪ NSV flow</li> <li>▪ NSV flow alternative</li> <li>▪ External pressure</li> <li>▪ Exciter current 1</li> <li>▪ Exciter current 2</li> <li>▪ Oscillation frequency 1</li> <li>▪ Oscillation frequency 2</li> <li>▪ S&amp;W volume flow</li> <li>▪ Reference density</li> <li>▪ Reference density alternative</li> <li>▪ Corrected volume flow</li> <li>▪ Oil corrected volume flow</li> </ul>
		<ul style="list-style-type: none"> <li>▪ Water corrected volume flow</li> <li>▪ Oscillation damping fluctuation 1</li> <li>▪ Oscillation damping fluctuation 2</li> <li>▪ Frequency fluctuation 1</li> <li>▪ Frequency fluctuation 2</li> <li>▪ Target mass flow</li> <li>▪ Carrier volume flow</li> <li>▪ Target volume flow</li> <li>▪ Temp. compensated dynamic viscosity</li> <li>▪ Temp. compensated kinematic viscosity</li> <li>▪ Temperature</li> <li>▪ Status</li> <li>▪ Volume flow</li> <li>▪ Oil volume flow</li> <li>▪ Water volume flow</li> <li>▪ Water cut</li> </ul>

1) Diagnostic behavior can be changed. This causes the overall status of the measured variable to change.

Diagnostic information		Remedy instructions
No.	Short text	
832	Electronic temperature too high	Reduce ambient temperature
<b>Measured variable status [from the factory] <sup>1)</sup></b>		
Quality	Bad	
Quality substatus	Process related	
Coding (hex)	0x28 to 0x2B	
Status signal	S	
Diagnostic behavior	Warning	
<b>Influenced measured variables</b>		
<ul style="list-style-type: none"> <li>▪ Oscillation amplitude 1</li> <li>▪ Oscillation amplitude 2</li> <li>▪ Signal asymmetry</li> <li>▪ Carrier mass flow</li> <li>▪ Carrier pipe temperature</li> <li>▪ Target corrected volume flow</li> <li>▪ Carrier corrected volume flow</li> <li>▪ Concentration</li> <li>▪ Measured values 1</li> <li>▪ Measured values 2</li> <li>▪ Measured values 3</li> <li>▪ Oscillation damping 1</li> <li>▪ Oscillation damping 2</li> <li>▪ Density</li> <li>▪ Oil density</li> <li>▪ Water density</li> <li>▪ Dynamic viscosity</li> <li>▪ Sensor electronic temperature (ISEM)</li> <li>▪ <b>Empty pipe detection</b> option</li> </ul>		<ul style="list-style-type: none"> <li>▪ GSV flow</li> <li>▪ GSV flow alternative</li> <li>▪ Kinematic viscosity</li> <li>▪ <b>Low flow cut off</b> option</li> <li>▪ Mass flow</li> <li>▪ Oil mass flow</li> <li>▪ Water mass flow</li> <li>▪ HBSI</li> <li>▪ NSV flow</li> <li>▪ NSV flow alternative</li> <li>▪ External pressure</li> <li>▪ Exciter current 1</li> <li>▪ Exciter current 2</li> <li>▪ Oscillation frequency 1</li> <li>▪ Oscillation frequency 2</li> <li>▪ S&amp;W volume flow</li> <li>▪ Reference density</li> <li>▪ Reference density alternative</li> <li>▪ Corrected volume flow</li> </ul>
		<ul style="list-style-type: none"> <li>▪ Oil corrected volume flow</li> <li>▪ Water corrected volume flow</li> <li>▪ Oscillation damping fluctuation 1</li> <li>▪ Oscillation damping fluctuation 2</li> <li>▪ Frequency fluctuation 1</li> <li>▪ Frequency fluctuation 2</li> <li>▪ Target mass flow</li> <li>▪ Carrier volume flow</li> <li>▪ Target volume flow</li> <li>▪ Temp. compensated dynamic viscosity</li> <li>▪ Temp. compensated kinematic viscosity</li> <li>▪ Temperature</li> <li>▪ Status</li> <li>▪ Volume flow</li> <li>▪ Oil volume flow</li> <li>▪ Water volume flow</li> <li>▪ Water cut</li> </ul>

1) Diagnostic behavior can be changed. This causes the overall status of the measured variable to change.

Diagnostic information		Remedy instructions
No.	Short text	
833	Electronic temperature too low	Increase ambient temperature
<b>Measured variable status [from the factory] <sup>1)</sup></b>		
Quality	Bad	
Quality substatus	Process related	
Coding (hex)	0x28 to 0x2B	
Status signal	S	
Diagnostic behavior	Warning	
<b>Influenced measured variables</b>		
<ul style="list-style-type: none"> <li>▪ Oscillation amplitude 1</li> <li>▪ Oscillation amplitude 2</li> <li>▪ Signal asymmetry</li> <li>▪ Carrier mass flow</li> <li>▪ Carrier pipe temperature</li> <li>▪ Target corrected volume flow</li> <li>▪ Carrier corrected volume flow</li> <li>▪ Concentration</li> <li>▪ Measured values 1</li> <li>▪ Measured values 2</li> <li>▪ Measured values 3</li> <li>▪ Oscillation damping 1</li> <li>▪ Oscillation damping 2</li> <li>▪ Density</li> <li>▪ Oil density</li> <li>▪ Water density</li> <li>▪ Dynamic viscosity</li> <li>▪ Sensor electronic temperature (ISEM)</li> <li>▪ <b>Empty pipe detection</b> option</li> </ul>		<ul style="list-style-type: none"> <li>▪ GSV flow</li> <li>▪ GSV flow alternative</li> <li>▪ Kinematic viscosity</li> <li>▪ <b>Low flow cut off</b> option</li> <li>▪ Mass flow</li> <li>▪ Oil mass flow</li> <li>▪ Water mass flow</li> <li>▪ HBSI</li> <li>▪ NSV flow</li> <li>▪ NSV flow alternative</li> <li>▪ External pressure</li> <li>▪ Exciter current 1</li> <li>▪ Exciter current 2</li> <li>▪ Oscillation frequency 1</li> <li>▪ Oscillation frequency 2</li> <li>▪ S&amp;W volume flow</li> <li>▪ Reference density</li> <li>▪ Reference density alternative</li> <li>▪ Corrected volume flow</li> </ul>
		<ul style="list-style-type: none"> <li>▪ Oil corrected volume flow</li> <li>▪ Water corrected volume flow</li> <li>▪ Oscillation damping fluctuation 1</li> <li>▪ Oscillation damping fluctuation 2</li> <li>▪ Frequency fluctuation 1</li> <li>▪ Frequency fluctuation 2</li> <li>▪ Target mass flow</li> <li>▪ Carrier volume flow</li> <li>▪ Target volume flow</li> <li>▪ Temp. compensated dynamic viscosity</li> <li>▪ Temp. compensated kinematic viscosity</li> <li>▪ Temperature</li> <li>▪ Status</li> <li>▪ Volume flow</li> <li>▪ Oil volume flow</li> <li>▪ Water volume flow</li> <li>▪ Water cut</li> </ul>

1) Diagnostic behavior can be changed. This causes the overall status of the measured variable to change.

Diagnostic information		Remedy instructions	
No.	Short text		
834	Process temperature too high	Reduce process temperature	
	<b>Measured variable status [from the factory] <sup>1)</sup></b>		
	Quality		Uncertain
	Quality substatus		Process related
	Coding (hex)		0x78 to 0x7B
	Status signal		S
	Diagnostic behavior		Warning
<b>Influenced measured variables</b>			
<ul style="list-style-type: none"> <li>▪ Oscillation amplitude 1</li> <li>▪ Oscillation amplitude 2</li> <li>▪ Signal asymmetry</li> <li>▪ Carrier mass flow</li> <li>▪ Carrier pipe temperature</li> <li>▪ Target corrected volume flow</li> <li>▪ Carrier corrected volume flow</li> <li>▪ Concentration</li> <li>▪ Oscillation damping 1</li> <li>▪ Oscillation damping 2</li> <li>▪ Density</li> <li>▪ Oil density</li> <li>▪ Water density</li> <li>▪ Dynamic viscosity</li> <li>▪ Sensor electronic temperature (ISEM)</li> <li>▪ <b>Empty pipe detection</b> option</li> <li>▪ GSV flow</li> <li>▪ GSV flow alternative</li> <li>▪ Kinematic viscosity</li> <li>▪ <b>Low flow cut off</b> option</li> <li>▪ Mass flow</li> <li>▪ Oil mass flow</li> <li>▪ Water mass flow</li> <li>▪ HBSI</li> <li>▪ NSV flow</li> <li>▪ NSV flow alternative</li> <li>▪ External pressure</li> <li>▪ Exciter current 1</li> <li>▪ Exciter current 2</li> <li>▪ Oscillation frequency 1</li> <li>▪ Oscillation frequency 2</li> <li>▪ S&amp;W volume flow</li> <li>▪ Reference density</li> <li>▪ Reference density alternative</li> <li>▪ Corrected volume flow</li> <li>▪ Oil corrected volume flow</li> <li>▪ Water corrected volume flow</li> <li>▪ Oscillation damping fluctuation 1</li> <li>▪ Oscillation damping fluctuation 2</li> <li>▪ Frequency fluctuation 1</li> <li>▪ Frequency fluctuation 2</li> <li>▪ Target mass flow</li> <li>▪ Carrier volume flow</li> <li>▪ Target volume flow</li> <li>▪ Temp. compensated dynamic viscosity</li> <li>▪ Temp. compensated kinematic viscosity</li> <li>▪ Temperature</li> <li>▪ Status</li> <li>▪ Volume flow</li> <li>▪ Oil volume flow</li> <li>▪ Water volume flow</li> <li>▪ Water cut</li> </ul>			

1) Diagnostic behavior can be changed. This causes the overall status of the measured variable to change.

Diagnostic information		Remedy instructions
No.	Short text	
835	Process temperature too low	Increase process temperature
<b>Measured variable status [from the factory] <sup>1)</sup></b>		
Quality	Uncertain	
Quality substatus	Process related	
Coding (hex)	0x78 to 0x7B	
Status signal	S	
Diagnostic behavior	Warning	
<b>Influenced measured variables</b>		
<ul style="list-style-type: none"> <li>▪ Oscillation amplitude 1</li> <li>▪ Oscillation amplitude 2</li> <li>▪ Signal asymmetry</li> <li>▪ Carrier mass flow</li> <li>▪ Carrier pipe temperature</li> <li>▪ Target corrected volume flow</li> <li>▪ Carrier corrected volume flow</li> <li>▪ Concentration</li> <li>▪ Oscillation damping 1</li> <li>▪ Oscillation damping 2</li> <li>▪ Density</li> <li>▪ Oil density</li> <li>▪ Water density</li> <li>▪ Dynamic viscosity</li> <li>▪ Sensor electronic temperature (ISEM)</li> <li>▪ <b>Empty pipe detection</b> option</li> <li>▪ GSV flow</li> <li>▪ GSV flow alternative</li> </ul>		<ul style="list-style-type: none"> <li>▪ Kinematic viscosity</li> <li>▪ <b>Low flow cut off</b> option</li> <li>▪ Mass flow</li> <li>▪ Oil mass flow</li> <li>▪ Water mass flow</li> <li>▪ HBSI</li> <li>▪ NSV flow</li> <li>▪ NSV flow alternative</li> <li>▪ External pressure</li> <li>▪ Exciter current 1</li> <li>▪ Exciter current 2</li> <li>▪ Oscillation frequency 1</li> <li>▪ Oscillation frequency 2</li> <li>▪ S&amp;W volume flow</li> <li>▪ Reference density</li> <li>▪ Reference density alternative</li> <li>▪ Corrected volume flow</li> <li>▪ Oil corrected volume flow</li> </ul>
		<ul style="list-style-type: none"> <li>▪ Water corrected volume flow</li> <li>▪ Oscillation damping fluctuation 1</li> <li>▪ Oscillation damping fluctuation 2</li> <li>▪ Frequency fluctuation 1</li> <li>▪ Frequency fluctuation 2</li> <li>▪ Target mass flow</li> <li>▪ Carrier volume flow</li> <li>▪ Target volume flow</li> <li>▪ Temp. compensated dynamic viscosity</li> <li>▪ Temp. compensated kinematic viscosity</li> <li>▪ Temperature</li> <li>▪ Status</li> <li>▪ Volume flow</li> <li>▪ Oil volume flow</li> <li>▪ Water volume flow</li> <li>▪ Water cut</li> </ul>

1) Diagnostic behavior can be changed. This causes the overall status of the measured variable to change.

Diagnostic information		Remedy instructions	
No.	Short text		
842	Process limit	Low flow cut off active! 1. Check low flow cut off configuration	
	<b>Measured variable status [from the factory] <sup>1)</sup></b>		
	Quality		Uncertain
	Quality substatus		Process related
	Coding (hex)		0x78 to 0x7B
	Status signal		S
	Diagnostic behavior		Warning
<b>Influenced measured variables</b>			
<ul style="list-style-type: none"> <li>▪ Oscillation amplitude 1</li> <li>▪ Oscillation amplitude 2</li> <li>▪ Signal asymmetry</li> <li>▪ Carrier mass flow</li> <li>▪ Carrier pipe temperature</li> <li>▪ Target corrected volume flow</li> <li>▪ Carrier corrected volume flow</li> <li>▪ Concentration</li> <li>▪ Oscillation damping 1</li> <li>▪ Oscillation damping 2</li> <li>▪ Density</li> <li>▪ Oil density</li> <li>▪ Water density</li> <li>▪ Dynamic viscosity</li> <li>▪ Sensor electronic temperature (ISEM)</li> <li>▪ <b>Empty pipe detection</b> option</li> <li>▪ GSV flow</li> <li>▪ GSV flow alternative</li> <li>▪ Kinematic viscosity</li> <li>▪ <b>Low flow cut off</b> option</li> <li>▪ Mass flow</li> <li>▪ Oil mass flow</li> <li>▪ Water mass flow</li> <li>▪ HBSI</li> <li>▪ NSV flow</li> <li>▪ NSV flow alternative</li> <li>▪ External pressure</li> <li>▪ Exciter current 1</li> <li>▪ Exciter current 2</li> <li>▪ Oscillation frequency 1</li> <li>▪ Oscillation frequency 2</li> <li>▪ S&amp;W volume flow</li> <li>▪ Reference density</li> <li>▪ Reference density alternative</li> <li>▪ Corrected volume flow</li> <li>▪ Oil corrected volume flow</li> <li>▪ Water corrected volume flow</li> <li>▪ Oscillation damping fluctuation 1</li> <li>▪ Oscillation damping fluctuation 2</li> <li>▪ Frequency fluctuation 1</li> <li>▪ Frequency fluctuation 2</li> <li>▪ Target mass flow</li> <li>▪ Carrier volume flow</li> <li>▪ Target volume flow</li> <li>▪ Temp. compensated dynamic viscosity</li> <li>▪ Temp. compensated kinematic viscosity</li> <li>▪ Temperature</li> <li>▪ Status</li> <li>▪ Volume flow</li> <li>▪ Oil volume flow</li> <li>▪ Water volume flow</li> <li>▪ Water cut</li> </ul>			

1) Diagnostic behavior can be changed. This causes the overall status of the measured variable to change.

Diagnostic information		Remedy instructions	
No.	Short text		
862	Partly filled pipe	1. Check for gas in process 2. Adjust detection limits	
	<b>Measured variable status [from the factory] <sup>1)</sup></b>		
	Quality		Bad
	Quality substatus		Process related
	Coding (hex)		0x28 to 0x2B
	Status signal		S
	Diagnostic behavior		Warning
<b>Influenced measured variables</b>			
<ul style="list-style-type: none"> <li>▪ Carrier mass flow</li> <li>▪ Target corrected volume flow</li> <li>▪ Carrier corrected volume flow</li> <li>▪ Concentration</li> <li>▪ Density</li> <li>▪ Oil density</li> <li>▪ Water density</li> <li>▪ Dynamic viscosity</li> <li>▪ <b>Empty pipe detection</b> option</li> <li>▪ GSV flow</li> <li>▪ GSV flow alternative</li> <li>▪ Kinematic viscosity</li> <li>▪ <b>Low flow cut off</b> option</li> <li>▪ Mass flow</li> <li>▪ Oil mass flow</li> <li>▪ Water mass flow</li> <li>▪ HBSI</li> <li>▪ NSV flow</li> <li>▪ NSV flow alternative</li> <li>▪ External pressure</li> <li>▪ S&amp;W volume flow</li> <li>▪ Reference density</li> <li>▪ Reference density alternative</li> <li>▪ Corrected volume flow</li> <li>▪ Oil corrected volume flow</li> <li>▪ Water corrected volume flow</li> <li>▪ Target mass flow</li> <li>▪ Carrier volume flow</li> <li>▪ Target volume flow</li> <li>▪ Temp. compensated dynamic viscosity</li> <li>▪ Temp. compensated kinematic viscosity</li> <li>▪ Temperature</li> <li>▪ Status</li> <li>▪ Volume flow</li> <li>▪ Oil volume flow</li> <li>▪ Water volume flow</li> <li>▪ Water cut</li> </ul>			

1) Diagnostic behavior can be changed. This causes the overall status of the measured variable to change.

Diagnostic information		Remedy instructions	
No.	Short text		
882	Input signal	1. Check input configuration 2. Check external device or process conditions	
	<b>Measured variable status</b>		
	Quality		Bad
	Quality substatus		Maintenance alarm
	Coding (hex)		0x24 to 0x27
	Status signal		F
	Diagnostic behavior		Alarm
<b>Influenced measured variables</b>			
<ul style="list-style-type: none"> <li>▪ Oscillation amplitude 1</li> <li>▪ Oscillation amplitude 2</li> <li>▪ Signal asymmetry</li> <li>▪ Carrier mass flow</li> <li>▪ Carrier pipe temperature</li> <li>▪ Target corrected volume flow</li> <li>▪ Carrier corrected volume flow</li> <li>▪ Concentration</li> <li>▪ Measured values 1</li> <li>▪ Measured values 2</li> <li>▪ Measured values 3</li> <li>▪ Oscillation damping 1</li> <li>▪ Oscillation damping 2</li> <li>▪ Density</li> <li>▪ Oil density</li> <li>▪ Water density</li> <li>▪ Dynamic viscosity</li> <li>▪ Sensor electronic temperature (ISEM)</li> <li>▪ <b>Empty pipe detection</b> option</li> <li>▪ GSV flow</li> <li>▪ GSV flow alternative</li> <li>▪ Kinematic viscosity</li> <li>▪ <b>Low flow cut off</b> option</li> <li>▪ Mass flow</li> <li>▪ Oil mass flow</li> <li>▪ Water mass flow</li> <li>▪ HBSI</li> <li>▪ NSV flow</li> <li>▪ NSV flow alternative</li> <li>▪ External pressure</li> <li>▪ Exciter current 1</li> <li>▪ Exciter current 2</li> <li>▪ Oscillation frequency 1</li> <li>▪ Oscillation frequency 2</li> <li>▪ S&amp;W volume flow</li> <li>▪ Reference density</li> <li>▪ Reference density alternative</li> <li>▪ Corrected volume flow</li> <li>▪ Oil corrected volume flow</li> <li>▪ Water corrected volume flow</li> <li>▪ Oscillation damping fluctuation 1</li> <li>▪ Oscillation damping fluctuation 2</li> <li>▪ Frequency fluctuation 1</li> <li>▪ Frequency fluctuation 2</li> <li>▪ Target mass flow</li> <li>▪ Carrier volume flow</li> <li>▪ Target volume flow</li> <li>▪ Temp. compensated dynamic viscosity</li> <li>▪ Temp. compensated kinematic viscosity</li> <li>▪ Temperature</li> <li>▪ Status</li> <li>▪ Volume flow</li> <li>▪ Oil volume flow</li> <li>▪ Water volume flow</li> <li>▪ Water cut</li> </ul>			



Diagnostic information		Remedy instructions	
No.	Short text		
910	Tubes not oscillating	1. Check electronic 2. Inspect sensor	
	<b>Measured variable status</b>		
	Quality		Bad
	Quality substatus		Maintenance alarm
	Coding (hex)		0x24 to 0x27
	Status signal		F
	Diagnostic behavior		Alarm
<b>Influenced measured variables</b>			
<ul style="list-style-type: none"> <li>▪ Oscillation amplitude 1</li> <li>▪ Oscillation amplitude 2</li> <li>▪ Signal asymmetry</li> <li>▪ Carrier mass flow</li> <li>▪ Carrier pipe temperature</li> <li>▪ Target corrected volume flow</li> <li>▪ Carrier corrected volume flow</li> <li>▪ Concentration</li> <li>▪ Oscillation damping 1</li> <li>▪ Oscillation damping 2</li> <li>▪ Density</li> <li>▪ Oil density</li> <li>▪ Water density</li> <li>▪ Dynamic viscosity</li> <li>▪ Sensor electronic temperature (ISEM)</li> <li>▪ <b>Empty pipe detection</b> option</li> <li>▪ GSV flow</li> <li>▪ GSV flow alternative</li> </ul>		<ul style="list-style-type: none"> <li>▪ Kinematic viscosity</li> <li>▪ <b>Low flow cut off</b> option</li> <li>▪ Mass flow</li> <li>▪ Oil mass flow</li> <li>▪ Water mass flow</li> <li>▪ HBSI</li> <li>▪ NSV flow</li> <li>▪ NSV flow alternative</li> <li>▪ External pressure</li> <li>▪ Exciter current 1</li> <li>▪ Exciter current 2</li> <li>▪ Oscillation frequency 1</li> <li>▪ Oscillation frequency 2</li> <li>▪ S&amp;W volume flow</li> <li>▪ Reference density</li> <li>▪ Reference density alternative</li> <li>▪ Corrected volume flow</li> <li>▪ Oil corrected volume flow</li> </ul>	
		<ul style="list-style-type: none"> <li>▪ Water corrected volume flow</li> <li>▪ Oscillation damping fluctuation 1</li> <li>▪ Oscillation damping fluctuation 2</li> <li>▪ Frequency fluctuation 1</li> <li>▪ Frequency fluctuation 2</li> <li>▪ Target mass flow</li> <li>▪ Carrier volume flow</li> <li>▪ Target volume flow</li> <li>▪ Temp. compensated dynamic viscosity</li> <li>▪ Temp. compensated kinematic viscosity</li> <li>▪ Temperature</li> <li>▪ Status</li> <li>▪ Volume flow</li> <li>▪ Oil volume flow</li> <li>▪ Water volume flow</li> <li>▪ Water cut</li> </ul>	

Diagnostic information		Remedy instructions	
No.	Short text		
912	Medium inhomogeneous	1. Check process cond. 2. Increase system pressure	
	<b>Measured variable status [from the factory] <sup>1)</sup></b>		
	Quality		Uncertain
	Quality substatus		Process related
	Coding (hex)		0x78 to 0x7B
	Status signal		S
	Diagnostic behavior		Warning
<b>Influenced measured variables</b>			
<ul style="list-style-type: none"> <li>▪ Oscillation amplitude 1</li> <li>▪ Oscillation amplitude 2</li> <li>▪ Signal asymmetry</li> <li>▪ Carrier mass flow</li> <li>▪ Carrier pipe temperature</li> <li>▪ Target corrected volume flow</li> <li>▪ Carrier corrected volume flow</li> <li>▪ Concentration</li> <li>▪ Oscillation damping 1</li> <li>▪ Oscillation damping 2</li> <li>▪ Density</li> <li>▪ Oil density</li> <li>▪ Water density</li> <li>▪ Dynamic viscosity</li> <li>▪ Sensor electronic temperature (ISEM)</li> <li>▪ <b>Empty pipe detection</b> option</li> <li>▪ GSV flow</li> <li>▪ GSV flow alternative</li> <li>▪ Kinematic viscosity</li> <li>▪ <b>Low flow cut off</b> option</li> <li>▪ Mass flow</li> <li>▪ Oil mass flow</li> <li>▪ Water mass flow</li> <li>▪ HBSI</li> <li>▪ NSV flow</li> <li>▪ NSV flow alternative</li> <li>▪ External pressure</li> <li>▪ Exciter current 1</li> <li>▪ Exciter current 2</li> <li>▪ Oscillation frequency 1</li> <li>▪ Oscillation frequency 2</li> <li>▪ S&amp;W volume flow</li> <li>▪ Reference density</li> <li>▪ Reference density alternative</li> <li>▪ Corrected volume flow</li> <li>▪ Oil corrected volume flow</li> <li>▪ Water corrected volume flow</li> <li>▪ Oscillation damping fluctuation 1</li> <li>▪ Oscillation damping fluctuation 2</li> <li>▪ Frequency fluctuation 1</li> <li>▪ Frequency fluctuation 2</li> <li>▪ Target mass flow</li> <li>▪ Carrier volume flow</li> <li>▪ Target volume flow</li> <li>▪ Temp. compensated dynamic viscosity</li> <li>▪ Temp. compensated kinematic viscosity</li> <li>▪ Temperature</li> <li>▪ Status</li> <li>▪ Volume flow</li> <li>▪ Oil volume flow</li> <li>▪ Water volume flow</li> <li>▪ Water cut</li> </ul>			

1) Diagnostic behavior can be changed. This causes the overall status of the measured variable to change.

Diagnostic information		Remedy instructions	
No.	Short text		
913	Medium unsuitable	1. Check process conditions 2. Check electronic modules or sensor	
	<b>Measured variable status [from the factory] <sup>1)</sup></b>		
	Quality		Uncertain
	Quality substatus		Process related
	Coding (hex)		0x78 to 0x7B
	Status signal		S
	Diagnostic behavior		Warning
<b>Influenced measured variables</b>			
<ul style="list-style-type: none"> <li>▪ Oscillation amplitude 1</li> <li>▪ Oscillation amplitude 2</li> <li>▪ Signal asymmetry</li> <li>▪ Carrier mass flow</li> <li>▪ Carrier pipe temperature</li> <li>▪ Target corrected volume flow</li> <li>▪ Carrier corrected volume flow</li> <li>▪ Concentration</li> <li>▪ Oscillation damping 1</li> <li>▪ Oscillation damping 2</li> <li>▪ Density</li> <li>▪ Oil density</li> <li>▪ Water density</li> <li>▪ Dynamic viscosity</li> <li>▪ Sensor electronic temperature (ISEM)</li> <li>▪ <b>Empty pipe detection</b> option</li> <li>▪ GSV flow</li> <li>▪ GSV flow alternative</li> <li>▪ Kinematic viscosity</li> <li>▪ <b>Low flow cut off</b> option</li> <li>▪ Mass flow</li> <li>▪ Oil mass flow</li> <li>▪ Water mass flow</li> <li>▪ HBSI</li> <li>▪ NSV flow</li> <li>▪ NSV flow alternative</li> <li>▪ External pressure</li> <li>▪ Exciter current 1</li> <li>▪ Exciter current 2</li> <li>▪ Oscillation frequency 1</li> <li>▪ Oscillation frequency 2</li> <li>▪ S&amp;W volume flow</li> <li>▪ Reference density</li> <li>▪ Reference density alternative</li> <li>▪ Corrected volume flow</li> <li>▪ Oil corrected volume flow</li> <li>▪ Water corrected volume flow</li> <li>▪ Oscillation damping fluctuation 1</li> <li>▪ Oscillation damping fluctuation 2</li> <li>▪ Frequency fluctuation 1</li> <li>▪ Frequency fluctuation 2</li> <li>▪ Target mass flow</li> <li>▪ Carrier volume flow</li> <li>▪ Target volume flow</li> <li>▪ Temp. compensated dynamic viscosity</li> <li>▪ Temp. compensated kinematic viscosity</li> <li>▪ Temperature</li> <li>▪ Status</li> <li>▪ Volume flow</li> <li>▪ Oil volume flow</li> <li>▪ Water volume flow</li> <li>▪ Water cut</li> </ul>			

1) Diagnostic behavior can be changed. This causes the overall status of the measured variable to change.

Diagnostic information		Remedy instructions	
No.	Short text		
941	API temperature out of specification	1. Check process temperature with selected API commodity group 2. Check API related parameters	
	<b>Measured variable status</b>		
	Quality		Bad
	Quality substatus		Maintenance alarm
	Coding (hex)		0x24 to 0x27
	Status signal		S
	Diagnostic behavior		Alarm
<b>Influenced measured variables</b>			
<ul style="list-style-type: none"> <li>▪ Oil density</li> <li>▪ Water density</li> <li>▪ GSV flow</li> <li>▪ GSV flow alternative</li> <li>▪ Mass flow</li> <li>▪ Oil mass flow</li> <li>▪ Water mass flow</li> <li>▪ NSV flow</li> <li>▪ NSV flow alternative</li> <li>▪ External pressure</li> <li>▪ S&amp;W volume flow</li> <li>▪ Reference density alternative</li> <li>▪ Corrected volume flow</li> <li>▪ Oil corrected volume flow</li> <li>▪ Water corrected volume flow</li> <li>▪ Oil volume flow</li> <li>▪ Water volume flow</li> <li>▪ Water cut</li> </ul>			

Diagnostic information		Remedy instructions
No.	Short text	
942	API density out of specification	1. Check process density with selected API commodity group 2. Check API related parameters
<b>Measured variable status</b>		
Quality	Bad	
Quality substatus	Maintenance alarm	
Coding (hex)	0x24 to 0x27	
Status signal	S	
Diagnostic behavior	Alarm	
<b>Influenced measured variables</b>		
Mass flow		

Diagnostic information		Remedy instructions
No.	Short text	
943	API pressure out of specification	1. Check process pressure with selected API commodity group 2. Check API related parameters
<b>Measured variable status</b>		
Quality	Bad	
Quality substatus	Maintenance alarm	
Coding (hex)	0x24 to 0x27	
Status signal	S	
Diagnostic behavior	Alarm	
<b>Influenced measured variables</b>		
<ul style="list-style-type: none"> <li>▪ Oil density</li> <li>▪ Water density</li> <li>▪ GSV flow</li> <li>▪ GSV flow alternative</li> <li>▪ Mass flow</li> <li>▪ Oil mass flow</li> <li>▪ Water mass flow</li> <li>▪ NSV flow</li> <li>▪ NSV flow alternative</li> <li>▪ External pressure</li> <li>▪ S&amp;W volume flow</li> <li>▪ Reference density alternative</li> <li>▪ Corrected volume flow</li> <li>▪ Oil corrected volume flow</li> <li>▪ Water corrected volume flow</li> <li>▪ Oil volume flow</li> <li>▪ Water volume flow</li> <li>▪ Water cut</li> </ul>		

Diagnostic information		Remedy instructions	
No.	Short text		
944	Monitoring failed	Check process conditions for Heartbeat Monitoring	
	<b>Measured variable status [from the factory] <sup>1)</sup></b>		
	Quality		Bad
	Quality substatus		Maintenance alarm
	Coding (hex)		0x24 to 0x27
	Status signal		S
	Diagnostic behavior		Warning
<b>Influenced measured variables</b>			
<ul style="list-style-type: none"> <li>▪ Oscillation amplitude 1</li> <li>▪ Oscillation amplitude 2</li> <li>▪ Signal asymmetry</li> <li>▪ Carrier mass flow</li> <li>▪ Carrier pipe temperature</li> <li>▪ Concentration</li> <li>▪ Oscillation damping 1</li> <li>▪ Oscillation damping 2</li> <li>▪ Density</li> <li>▪ Dynamic viscosity</li> <li>▪ Sensor electronic temperature (ISEM)</li> <li>▪ <b>Empty pipe detection</b> option</li> <li>▪ Kinematic viscosity</li> <li>▪ <b>Low flow cut off</b> option</li> <li>▪ Mass flow</li> <li>▪ HBSI</li> <li>▪ External pressure</li> <li>▪ Exciter current 1</li> <li>▪ Exciter current 2</li> <li>▪ Oscillation frequency 1</li> <li>▪ Oscillation frequency 2</li> <li>▪ Reference density</li> <li>▪ Corrected volume flow</li> <li>▪ Oscillation damping fluctuation 1</li> <li>▪ Oscillation damping fluctuation 2</li> <li>▪ Frequency fluctuation 1</li> <li>▪ Frequency fluctuation 2</li> <li>▪ Target mass flow</li> <li>▪ Temp. compensated dynamic viscosity</li> <li>▪ Temp. compensated kinematic viscosity</li> <li>▪ Temperature</li> <li>▪ Status</li> <li>▪ Volume flow</li> </ul>			

1) Diagnostic behavior can be changed. This causes the overall status of the measured variable to change.





Diagnostic information		Remedy instructions	
No.	Short text		
948	Oscillation damping too high	Check process conditions	
	<b>Measured variable status [from the factory] <sup>1)</sup></b>		
	Quality		Uncertain
	Quality substatus		Process related
	Coding (hex)		0x78 to 0x7B
	Status signal		S
	Diagnostic behavior		Warning
<b>Influenced measured variables</b>			
<ul style="list-style-type: none"> <li>▪ Oscillation amplitude 1</li> <li>▪ Oscillation amplitude 2</li> <li>▪ Signal asymmetry</li> <li>▪ Carrier mass flow</li> <li>▪ Carrier pipe temperature</li> <li>▪ Target corrected volume flow</li> <li>▪ Carrier corrected volume flow</li> <li>▪ Concentration</li> <li>▪ Oscillation damping 1</li> <li>▪ Oscillation damping 2</li> <li>▪ Density</li> <li>▪ Oil density</li> <li>▪ Water density</li> <li>▪ Dynamic viscosity</li> <li>▪ Sensor electronic temperature (ISEM)</li> <li>▪ <b>Empty pipe detection</b> option</li> <li>▪ GSV flow</li> <li>▪ GSV flow alternative</li> <li>▪ Kinematic viscosity</li> <li>▪ <b>Low flow cut off</b> option</li> <li>▪ Mass flow</li> <li>▪ Oil mass flow</li> <li>▪ Water mass flow</li> <li>▪ HBSI</li> <li>▪ NSV flow</li> <li>▪ NSV flow alternative</li> <li>▪ External pressure</li> <li>▪ Exciter current 1</li> <li>▪ Exciter current 2</li> <li>▪ Oscillation frequency 1</li> <li>▪ Oscillation frequency 2</li> <li>▪ S&amp;W volume flow</li> <li>▪ Reference density</li> <li>▪ Reference density alternative</li> <li>▪ Corrected volume flow</li> <li>▪ Oil corrected volume flow</li> <li>▪ Water corrected volume flow</li> <li>▪ Oscillation damping fluctuation 1</li> <li>▪ Oscillation damping fluctuation 2</li> <li>▪ Frequency fluctuation 1</li> <li>▪ Frequency fluctuation 2</li> <li>▪ Target mass flow</li> <li>▪ Carrier volume flow</li> <li>▪ Target volume flow</li> <li>▪ Temp. compensated dynamic viscosity</li> <li>▪ Temp. compensated kinematic viscosity</li> <li>▪ Temperature</li> <li>▪ Status</li> <li>▪ Volume flow</li> <li>▪ Oil volume flow</li> <li>▪ Water volume flow</li> <li>▪ Water cut</li> </ul>			



1) Diagnostic behavior can be changed. This causes the overall status of the measured variable to change.

## 12.8 Pending diagnostic events

The **Diagnostics** menu allows the user to view the current diagnostic event and the previous diagnostic event separately.





 To call up the measures to rectify a diagnostic event:

- Via local display →  169
- Via Web browser →  170
- Via "FieldCare" operating tool →  171
- Via "DeviceCare" operating tool →  171

 Other pending diagnostic events can be displayed in the **Diagnostic list** submenu →  226

### Navigation

"Diagnostics" menu

 <b>Diagnostics</b>	
Actual diagnostics	→  226
Previous diagnostics	→  226
Operating time from restart	→  226
Operating time	→  226

### Parameter overview with brief description

Parameter	Prerequisite	Description	User interface
Actual diagnostics	A diagnostic event has occurred.	Shows the current occurred diagnostic event along with its diagnostic information.  If two or more messages occur simultaneously, the message with the highest priority is shown on the display.	Symbol for diagnostic behavior, diagnostic code and short message.
Previous diagnostics	Two diagnostic events have already occurred.	Shows the diagnostic event that occurred prior to the current diagnostic event along with its diagnostic information.	Symbol for diagnostic behavior, diagnostic code and short message.
Operating time from restart	–	Shows the time the device has been in operation since the last device restart.	Days (d), hours (h), minutes (m) and seconds (s)
Operating time	–	Indicates how long the device has been in operation.	Days (d), hours (h), minutes (m) and seconds (s)

## 12.9 Diagnostic list

Up to 5 currently pending diagnostic events can be displayed in the **Diagnostic list** submenu along with the associated diagnostic information. If more than 5 diagnostic events are pending, the events with the highest priority are shown on the display.

### Navigation path

Diagnostics → Diagnostic list

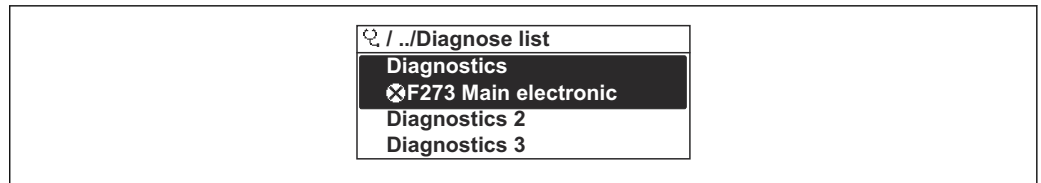

A0014006-EN

37 Taking the example of the local display

- i** To call up the measures to rectify a diagnostic event:
- Via local display → 169
  - Via Web browser → 170
  - Via "FieldCare" operating tool → 171
  - Via "DeviceCare" operating tool → 171

## 12.10 Event logbook

### 12.10.1 Reading out the event logbook

A chronological overview of the event messages that have occurred is provided in the **Events list** submenu.

#### Navigation path

**Diagnostics** menu → **Event logbook** submenu → Event list

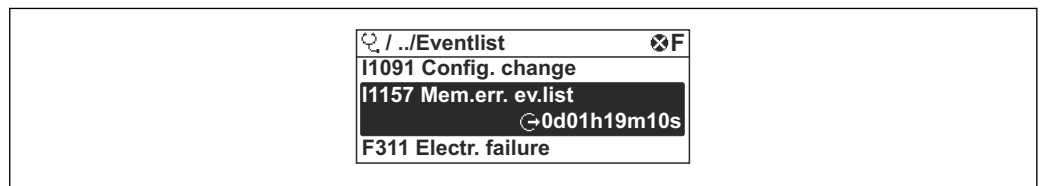

A0014008-EN

38 Taking the example of the local display

- A maximum of 20 event messages can be displayed in chronological order.
- If the **Extended HistoROM** application package (order option) is enabled in the device, the event list can contain up to 100 entries .

The event history includes entries for:

- Diagnostic events → 175
- Information events → 228

In addition to the operation time of its occurrence, each event is also assigned a symbol that indicates whether the event has occurred or is ended:

- Diagnostic event
  - ☒: Occurrence of the event
  - ☑: End of the event
- Information event
  - ☒: Occurrence of the event

- i** To call up the measures to rectify a diagnostic event:
- Via local display → 169
  - Via Web browser → 170
  - Via "FieldCare" operating tool → 171
  - Via "DeviceCare" operating tool → 171

- i** For filtering the displayed event messages → 228

## 12.10.2 Filtering the event logbook

Using the **Filter options** parameter you can define which category of event message is displayed in the **Events list** submenu.

### Navigation path

Diagnostics → Event logbook → Filter options

### Filter categories

- All
- Failure (F)
- Function check (C)
- Out of specification (S)
- Maintenance required (M)
- Information (I)

## 12.10.3 Overview of information events

Unlike a diagnostic event, an information event is displayed in the event logbook only and not in the diagnostic list.

Info number	Info name
I1000	----- (Device ok)
I1079	Sensor changed
I1089	Power on
I1090	Configuration reset
I1091	Configuration changed
I1092	HistoROM backup deleted
I1111	Density adjust failure
I1137	Electronic changed
I1151	History reset
I1155	Reset electronic temperature
I1156	Memory error trend
I1157	Memory error event list
I1184	Display connected
I1209	Density adjustment ok
I1221	Zero point adjust failure
I1222	Zero point adjustment ok
I1256	Display: access status changed
I1278	I/O module reset detected
I1335	Firmware changed
I1361	Web server: login failed
I1397	Fieldbus: access status changed
I1398	CDI: access status changed
I1444	Device verification passed
I1445	Device verification failed
I1447	Record application reference data
I1448	Application reference data recorded
I1449	Recording application ref. data failed
I1450	Monitoring off



Info number	Info name
I1451	Monitoring on
I1457	Measured error verification failed
I1459	I/O module verification failed
I1460	HBSI verification failed
I1461	Sensor verification failed
I1462	Sensor electronic module verific. failed
I1512	Download started
I1513	Download finished
I1514	Upload started
I1515	Upload finished
I1618	I/O module 2 replaced
I1619	I/O module 3 replaced
I1621	I/O module 4 replaced
I1622	Calibration changed
I1624	Reset all totalizers
I1625	Write protection activated
I1626	Write protection deactivated
I1627	Web server: login successful
I1628	Display: login successful
I1629	CDI: login successful
I1631	Web server access changed
I1632	Display: login failed
I1633	CDI: login failed
I1634	Reset to factory settings
I1635	Reset to delivery settings
I1636	Fieldbus address reset
I1639	Max. switch cycles number reached
I1649	Hardware write protection activated
I1650	Hardware write protection deactivated
I1712	New flash file received
I1725	Sensor electronic module (ISEM) changed
I1726	Configuration backup failed

## 12.11 Resetting the measuring device

Using the **Device reset** parameter (→  143) it is possible to reset the entire device configuration or some of the configuration to a defined state.

### 12.11.1 Function scope of the "Device reset" parameter











Options	Description
Cancel	No action is executed and the user exits the parameter.
To delivery settings	Every parameter for which a customer-specific default setting was ordered is reset to this customer-specific value. All other parameters are reset to the factory setting.
Restart device	The restart resets every parameter whose data are in the volatile memory (RAM) to the factory setting (e.g. measured value data). The device configuration remains unchanged.
Restore S-DAT backup	Restore the data that are saved on the S-DAT. The data record is restored from the electronics memory to the S-DAT.  This option is displayed only in an alarm condition.

## 12.12 Device information





The **Device information** submenu contains all parameters that display different information for device identification.

### Navigation

"Diagnostics" menu → Device information

▶ Device information	
Device tag	→  231
Serial number	→  231
Firmware version	→  231
Device name	→  231
Order code	→  231
Extended order code 1	→  231
Extended order code 2	→  231
Extended order code 3	→  231
ENP version	→  231
PROFIBUS ident number	→  231
Status PROFIBUS Master Config	→  231

## Parameter overview with brief description

Parameter	Description	User interface	Factory setting
Device tag	Shows name of measuring point.	Max. 32 characters, such as letters, numbers or special characters (e.g. @, %, /).	Promass 500 DP
Serial number	Shows the serial number of the measuring device.	Max. 11-digit character string comprising letters and numbers.	–
Firmware version	Shows the device firmware version installed.	Character string in the format xx.yy.zz	–
Device name	Shows the name of the transmitter.  The name can be found on the nameplate of the transmitter.	Promass 300/500	–
Order code	Shows the device order code.  The order code can be found on the nameplate of the sensor and transmitter in the "Order code" field.	Character string composed of letters, numbers and certain punctuation marks (e.g. /).	–
Extended order code 1	Shows the 1st part of the extended order code.  The extended order code can also be found on the nameplate of the sensor and transmitter in the "Ext. ord. cd." field.	Character string	–
Extended order code 2	Shows the 2nd part of the extended order code.  The extended order code can also be found on the nameplate of the sensor and transmitter in the "Ext. ord. cd." field.	Character string	–
Extended order code 3	Shows the 3rd part of the extended order code.  The extended order code can also be found on the nameplate of the sensor and transmitter in the "Ext. ord. cd." field.	Character string	–
ENP version	Shows the version of the electronic nameplate (ENP).	Character string	–
PROFIBUS ident number	Displays the PROFIBUS identification number.	0 to FFFF	0x156D
Status PROFIBUS Master Config	Displays the status of the PROFIBUS Master configuration.	<ul style="list-style-type: none"> <li>■ Active</li> <li>■ Not active</li> </ul>	–

## 12.13 Firmware history

Release date	Firmware version	Order code for "Firmware version"	Firmware changes	Documentation type	Documentation
06.2018	01.00.zz	Option 75	Original firmware	Operating Instructions	

 It is possible to flash the firmware to the current version or the previous version using the service interface.

 For the compatibility of the firmware version with the previous version, the installed device description files and operating tools, observe the information about the device in the "Manufacturer's information" document.

 The manufacturer's information is available:

- In the Download Area of the Endress+Hauser web site: [www.endress.com](http://www.endress.com) → Downloads
- Specify the following details:
  - Product root: e.g. 8S5B  
The product root is the first part of the order code: see the nameplate on the device.
  - Text search: Manufacturer's information
  - Media type: Documentation – Technical Documentation

## 13 Maintenance

### 13.1 Maintenance tasks

No special maintenance work is required.

#### 13.1.1 Exterior cleaning

When cleaning the exterior of measuring devices, always use cleaning agents that do not attack the surface of the housing or the seals.

#### 13.1.2 Interior cleaning

Observe the following points for CIP and SIP cleaning:

- Use only cleaning agents to which the process-wetted materials are adequately resistant.
- Observe the maximum permitted medium temperature for the measuring device  
→  254.

Observe the following point for cleaning with pigs:

Observe the inside diameter of the measuring tube and process connection.

### 13.2 Measuring and test equipment

Endress+Hauser offers a wide variety of measuring and test equipment, such as W@M or device tests.

 Your Endress+Hauser Sales Center can provide detailed information on the services.

List of some of the measuring and testing equipment: →  236 →  238

### 13.3 Endress+Hauser services

Endress+Hauser offers a wide variety of services for maintenance such as recalibration, maintenance service or device tests.

 Your Endress+Hauser Sales Center can provide detailed information on the services.

## 14 Repair

### 14.1 General notes

#### 14.1.1 Repair and conversion concept

The Endress+Hauser repair and conversion concept provides for the following:

- The measuring devices have a modular design.
- Spare parts are grouped into logical kits with the associated Installation Instructions.
- Repairs are carried out by Endress+Hauser Service or by appropriately trained customers.
- Certified devices can only be converted to other certified devices by Endress+Hauser Service or at the factory.

#### 14.1.2 Notes for repair and conversion



For repair and modification of a measuring device, observe the following notes:

- ▶ Use only original Endress+Hauser spare parts.
- ▶ Carry out the repair according to the Installation Instructions.
- ▶ Observe the applicable standards, federal/national regulations, Ex documentation (XA) and certificates.
- ▶ Document every repair and each conversion and enter them into the *W@M* life cycle management database.

### 14.2 Spare parts

*W@M Device Viewer* ([www.endress.com/deviceviewer](http://www.endress.com/deviceviewer)):

All the spare parts for the measuring device, along with the order code, are listed here and can be ordered. If available, users can also download the associated Installation Instructions.

-  Measuring device serial number:
  - Is located on the nameplate of the device.
  - Can be read out via the **Serial number** parameter (→  231) in the **Device information** submenu.

### 14.3 Endress+Hauser services

Endress+Hauser offers a wide range of services.

-  Your Endress+Hauser Sales Center can provide detailed information on the services.

### 14.4 Return

The requirements for safe device return can vary depending on the device type and national legislation.

1. Refer to the website for more information:  
<http://www.endress.com/support/return-material>
2. Return the device if repairs or a factory calibration are required, or if the wrong device was ordered or delivered.

## 14.5 Disposal



If required by the Directive 2012/19/EU on waste electrical and electronic equipment (WEEE), the product is marked with the depicted symbol in order to minimize the disposal of WEEE as unsorted municipal waste. Do not dispose of products bearing this marking as unsorted municipal waste. Instead, return them to Endress+Hauser for disposal under the applicable conditions.

### 14.5.1 Removing the measuring device

1. Switch off the device.

#### **⚠ WARNING**

**Danger to persons from process conditions.**

- ▶ Beware of hazardous process conditions such as pressure in the measuring device, high temperatures or aggressive fluids.
2. Carry out the mounting and connection steps from the "Mounting the measuring device" and "Connecting the measuring device" sections in reverse order. Observe the safety instructions.

### 14.5.2 Disposing of the measuring device

#### **⚠ WARNING**

**Danger to personnel and environment from fluids that are hazardous to health.**

- ▶ Ensure that the measuring device and all cavities are free of fluid residues that are hazardous to health or the environment, e.g. substances that have permeated into crevices or diffused through plastic.

Observe the following notes during disposal:













- ▶ Observe valid federal/national regulations.
- ▶ Ensure proper separation and reuse of the device components.

## 15 Accessories





Various accessories, which can be ordered with the device or subsequently from Endress+Hauser, are available for the device. Detailed information on the order code in question is available from your local Endress+Hauser sales center or on the product page of the Endress+Hauser website: [www.endress.com](http://www.endress.com).

### 15.1 Device-specific accessories



#### 15.1.1 For the transmitter

Accessories	Description
Transmitter <ul style="list-style-type: none"> <li>▪ Proline 500 – digital</li> <li>▪ Proline 500</li> </ul>	Transmitter for replacement or storage. Use the order code to define the following specifications: <ul style="list-style-type: none"> <li>▪ Approvals</li> <li>▪ Output</li> <li>▪ Input</li> <li>▪ Display/operation</li> <li>▪ Housing</li> <li>▪ Software</li> </ul> <ul style="list-style-type: none"> <li> ▪ Proline 500 – digital transmitter: Order number: 8X5BXX-*****A</li> <li>▪ Proline 500 transmitter: Order number: 8X5BXX-*****B</li> </ul> <ul style="list-style-type: none"> <li> Proline 500 transmitter for replacement: It is essential to specify the serial number of the current transmitter when ordering. Based on the serial number, the device-specific data (e.g., calibration factors) of the replacement device can be used for the new transmitter.</li> </ul> <ul style="list-style-type: none"> <li> ▪ Proline 500 – digital transmitter: Installation Instructions EA01151D</li> <li>▪ Proline 500 transmitter: Installation Instructions EA01152D</li> </ul>
External WLAN antenna	External WLAN antenna with 1.5 m (59.1 in) connecting cable and two angle brackets. Order code for "Accessory enclosed", option P8 "Wireless antenna wide area". <ul style="list-style-type: none"> <li> ▪ The external WLAN antenna is not suitable for use in hygienic applications.</li> <li>▪ Further information on the WLAN interface →  83.</li> </ul> <ul style="list-style-type: none"> <li> Order number: 71351317</li> </ul> <ul style="list-style-type: none"> <li> Installation Instructions EA01238D</li> </ul>
Pipe mounting set	Pipe mounting set for transmitter. <ul style="list-style-type: none"> <li> Proline 500 – digital transmitter Order number: 71346427</li> </ul> <ul style="list-style-type: none"> <li> Installation Instructions EA01195D</li> </ul> <ul style="list-style-type: none"> <li> Proline 500 transmitter Order number: 71346428</li> </ul>
Protective cover Transmitter <ul style="list-style-type: none"> <li>▪ Proline 500 – digital</li> <li>▪ Proline 500</li> </ul>	Is used to protect the measuring device from the effects of the weather: e.g. rainwater, excess heating from direct sunlight. <ul style="list-style-type: none"> <li> ▪ Proline 500 – digital transmitter Order number: 71343504</li> <li>▪ Proline 500 transmitter Order number: 71343505</li> </ul> <ul style="list-style-type: none"> <li> Installation Instructions EA01191D</li> </ul>





Display guard Proline 500 – digital	Is used to protect the display against impact or scoring from sand in desert areas.  Order number: 71228792   Installation Instructions EA01093D
Connecting cable Proline 500 – digital Sensor – Transmitter	The connecting cable can be ordered directly with the measuring device (order code for "Cable, sensor connection) or as an accessory (order number DK8012).  The following cable lengths are available: order code for "Cable, sensor connection" <ul style="list-style-type: none"> <li>▪ Option B: 20 m (65 ft)</li> <li>▪ Option E: User configurable up to max. 50 m</li> <li>▪ Option F: User configurable up to max. 165 ft</li> </ul>  Maximum possible cable length for a Proline 500 – digital connecting cable: 300 m (1 000 ft)
Connecting cable Proline 500 Sensor – Transmitter	The connecting cable can be ordered directly with the measuring device (order code for "Cable, sensor connection") or as an accessory (order number DK8012).  The following cable lengths are available: order code for "Cable, sensor connection" <ul style="list-style-type: none"> <li>▪ Option 1: 5 m (16 ft)</li> <li>▪ Option 2: 10 m (32 ft)</li> <li>▪ Option 3: 20 m (65 ft)</li> </ul>  Possible cable length for a Proline 500 connecting cable: max. 20 m (65 ft)





### 15.1.2 For the sensor

Accessories	Description
Heating jacket	Is used to stabilize the temperature of the fluids in the sensor. Water, water vapor and other non-corrosive liquids are permitted for use as fluids.   If using oil as a heating medium, please consult with Endress+Hauser.  <ul style="list-style-type: none"> <li>▪ If ordered together with the measuring device:                      order code for "Enclosed accessories"  <ul style="list-style-type: none"> <li>▪ Option RB "heating jacket, G 1/2" internal thread"</li> <li>▪ Option RC "heating jacket, G 3/4" internal thread"</li> <li>▪ Option RD "Heating jacket, NPT 1/2" internal thread"</li> <li>▪ Option RE "Heating jacket, NPT 3/4" internal thread"</li> </ul> </li> <li>▪ If ordered subsequently:                      Use the order code with the product root DK8003.</li> </ul>  Special Documentation SD02162D

## 15.2 Service-specific accessories

Accessories	Description
Applicator	<p>Software for selecting and sizing Endress+Hauser measuring devices:</p> <ul style="list-style-type: none"> <li>Choice of measuring devices for industrial requirements</li> <li>Calculation of all the necessary data for identifying the optimum flowmeter: e.g. nominal diameter, pressure loss, flow velocity and accuracy.</li> <li>Graphic illustration of the calculation results</li> <li>Determination of the partial order code, administration, documentation and access to all project-related data and parameters over the entire life cycle of a project.</li> </ul> <p>Applicator is available:</p> <ul style="list-style-type: none"> <li>Via the Internet: <a href="https://portal.endress.com/webapp/applicator">https://portal.endress.com/webapp/applicator</a></li> <li>As a downloadable DVD for local PC installation.</li> </ul>
W@M	<p>W@M Life Cycle Management</p> <p>Improved productivity with information at your fingertips. Data relevant to a plant and its components is generated from the first stages of planning and during the asset's complete life cycle.</p> <p>W@M Life Cycle Management is an open and flexible information platform with online and on-site tools. Instant access for your staff to current, in-depth data shortens your plant's engineering time, speeds up procurement processes and increases plant uptime.</p> <p>Combined with the right services, W@M Life Cycle Management boosts productivity in every phase. For more information, visit <a href="http://www.endress.com/lifecyclemanagement">www.endress.com/lifecyclemanagement</a></p>
FieldCare	<p>FDT-based plant asset management tool from Endress+Hauser.</p> <p>It can configure all smart field units in your system and helps you manage them. By using the status information, it is also a simple but effective way of checking their status and condition.</p> <p> Operating Instructions BA00027S and BA00059S</p>
DeviceCare	<p>Tool to connect and configure Endress+Hauser field devices.</p> <p> Innovation brochure IN01047S</p>

## 15.3 System components

Accessories	Description
Memograph M graphic data manager	<p>The Memograph M graphic data manager provides information on all the relevant measured variables. Measured values are recorded correctly, limit values are monitored and measuring points analyzed. The data are stored in the 256 MB internal memory and also on a SD card or USB stick.</p> <p> <ul style="list-style-type: none"> <li>Technical Information TI00133R</li> <li>Operating Instructions BA00247R</li> </ul> </p>
Cerabar M	<p>The pressure transmitter for measuring the absolute and gauge pressure of gases, steam and liquids. It can be used to read in the operating pressure value.</p> <p> <ul style="list-style-type: none"> <li>Technical Information TI00426P and TI00436P</li> <li>Operating Instructions BA00200P and BA00382P</li> </ul> </p>
Cerabar S	<p>The pressure transmitter for measuring the absolute and gauge pressure of gases, steam and liquids. It can be used to read in the operating pressure value.</p> <p> <ul style="list-style-type: none"> <li>Technical Information TI00383P</li> <li>Operating Instructions BA00271P</li> </ul> </p>
iTEMP	<p>The temperature transmitters can be used in all applications and are suitable for the measurement of gases, steam and liquids. They can be used to read in the medium temperature.</p> <p> "Fields of Activity" document FA00006T</p>

## 16 Technical data

### 16.1 Application

The measuring device is intended only for the flow measurement of liquids.

Depending on the version ordered, the measuring device can also measure potentially explosive, flammable, poisonous and oxidizing media.

To ensure that the device remains in proper operating condition for its service life, use the measuring device only for media against which the process-wetted materials are sufficiently resistant.

### 16.2 Function and system design

---

Measuring principle

Mass flow measurement based on the Coriolis measuring principle

---

Measuring system

The measuring system consists of a transmitter and a sensor. The transmitter and sensor are mounted in physically separate locations. They are interconnected by connecting cables.

For information on the structure of the device →  15

## 16.3 Input

Measured variable

### Direct measured variables

- Mass flow
- Density
- Temperature

### Calculated measured variables



- Volume flow
- Corrected volume flow
- Reference density

Measuring range

### Measuring range for liquids

DN		Measuring range full scale values $\dot{m}_{\min(F)}$ to $\dot{m}_{\max(F)}$	
[mm]	[in]	[kg/h]	[lb/min]
8	$\frac{3}{8}$	0 to 2 000	0 to 73.50
15	$\frac{1}{2}$	0 to 6 500	0 to 238.9
25	1	0 to 18 000	0 to 661.5
40	$1\frac{1}{2}$	0 to 45 000	0 to 1 654
50	2	0 to 70 000	0 to 2 573

### Recommended measuring range

 Flow limit →  255

Operable flow range

Over 1000 : 1.



Flow rates above the preset full scale value do not override the electronics unit, with the result that the totalizer values are registered correctly.

Input signal

### External measured values

To increase the accuracy of certain measured variables, the automation system can continuously write various measured values to the measuring device:

- Operating pressure to increase accuracy (Endress+Hauser recommends the use of a pressure measuring device for absolute pressure, e.g. Cerabar M or Cerabar S)
- Medium temperature to increase accuracy (e.g. iTEMP)

 Various pressure and temperature measuring devices can be ordered from Endress +Hauser: see "Accessories" section →  238

#### Current input

The measured values are written from the automation system to the measuring device via the current input →  241.

#### Digital communication

The measured values are written from the automation system to the measuring device via PROFIBUS DP.

**Current input 0/4 to 20 mA**

<b>Current input</b>	0/4 to 20 mA (active/passive)
<b>Current span</b>	<ul style="list-style-type: none"> <li>▪ 4 to 20 mA (active)</li> <li>▪ 0/4 to 20 mA (passive)</li> </ul>
<b>Resolution</b>	1 $\mu$ A
<b>Voltage drop</b>	Typically: 0.6 to 2 V for 3.6 to 22 mA (passive)
<b>Maximum input voltage</b>	$\leq$ 30 V (passive)
<b>Open-circuit voltage</b>	$\leq$ 28.8 V (active)
<b>Possible input variables</b>	<ul style="list-style-type: none"> <li>▪ Pressure</li> <li>▪ Temperature</li> <li>▪ Density</li> </ul>

**Status input**

<b>Maximum input values</b>	<ul style="list-style-type: none"> <li>▪ DC -3 to 30 V</li> <li>▪ If status input is active (ON): <math>R_i &gt; 3 \text{ k}\Omega</math></li> </ul>
<b>Response time</b>	Configurable: 5 to 200 ms
<b>Input signal level</b>	<ul style="list-style-type: none"> <li>▪ Low signal: DC -3 to +5 V</li> <li>▪ High signal: DC 12 to 30 V</li> </ul>
<b>Assignable functions</b>	<ul style="list-style-type: none"> <li>▪ Off</li> <li>▪ Reset the individual totalizers separately</li> <li>▪ Reset all totalizers</li> <li>▪ Flow override</li> </ul>

## 16.4 Output

Output signal

**PROFIBUS DP**

Signal encoding	NRZ code
Data transfer	9.6 kBaud...12 MBaud

### Current output 4 to 20 mA

Signal mode	Can be set to: <ul style="list-style-type: none"> <li>▪ Active</li> <li>▪ Passive</li> </ul>
Current span	Can be set to: <ul style="list-style-type: none"> <li>▪ 4 to 20 mA NAMUR</li> <li>▪ 4 to 20 mA US</li> <li>▪ 4 to 20 mA</li> <li>▪ 0 to 20 mA (only if the signal mode is active)</li> <li>▪ Fixed current</li> </ul>
Maximum output values	22.5 mA
Open-circuit voltage	DC 28.8 V (active)
Maximum input voltage	DC 30 V (passive)
Load	0 to 700 Ω
Resolution	0.38 μA
Damping	Configurable: 0 to 999.9 s
Assignable measured variables	<ul style="list-style-type: none"> <li>▪ Mass flow</li> <li>▪ Volume flow</li> <li>▪ Corrected volume flow</li> <li>▪ Density</li> <li>▪ Reference density</li> <li>▪ Temperature</li> <li>▪ Electronics temperature</li> <li>▪ Oscillation frequency 0</li> <li>▪ Oscillation damping 0</li> <li>▪ Signal asymmetry</li> <li>▪ Exciter current 0</li> </ul> <p> The range of options increases if the measuring device has one or more application packages.</p>



### Current output 4 to 20 mA Ex i passive

Order code	"Output; input 2" (21), "Output; input 3" (022): Option C: current output 4 to 20 mA Ex i passive
Signal mode	Passive
Current span	Can be set to: <ul style="list-style-type: none"> <li>▪ 4 to 20 mA NAMUR</li> <li>▪ 4 to 20 mA US</li> <li>▪ 4 to 20 mA</li> <li>▪ Fixed current</li> </ul>
Maximum output values	22.5 mA
Maximum input voltage	DC 30 V
Load	0 to 700 Ω
Resolution	0.38 μA

<b>Damping</b>	Configurable: 0 to 999 s
<b>Assignable measured variables</b>	<ul style="list-style-type: none"> <li>▪ Mass flow</li> <li>▪ Volume flow</li> <li>▪ Corrected volume flow</li> <li>▪ Density</li> <li>▪ Reference density</li> <li>▪ Temperature</li> <li>▪ Electronics temperature</li> <li>▪ Oscillation frequency 0</li> <li>▪ Oscillation damping 0</li> <li>▪ Signal asymmetry</li> <li>▪ Exciter current 0</li> </ul> <p> The range of options increases if the measuring device has one or more application packages.</p>

### Pulse/frequency/switch output

<b>Function</b>	Can be set to pulse, frequency or switch output
<b>Version</b>	Open collector Can be set to: <ul style="list-style-type: none"> <li>▪ Active</li> <li>▪ Passive</li> <li>▪ Passive NAMUR</li> </ul> <p> Ex-i, passive</p>
<b>Maximum input values</b>	DC 30 V, 250 mA (passive)
<b>Open-circuit voltage</b>	DC 28.8 V (active)
<b>Voltage drop</b>	For 22.5 mA: ≤ DC 2 V
<b>Pulse output</b>	
<b>Maximum input values</b>	DC 30 V, 250 mA (passive)
<b>Maximum output current</b>	22.5 mA (active)
<b>Open-circuit voltage</b>	DC 28.8 V (active)
<b>Pulse width</b>	Configurable: 0.05 to 2 000 ms
<b>Maximum pulse rate</b>	10 000 Impulse/s
<b>Pulse value</b>	Adjustable
<b>Assignable measured variables</b>	<ul style="list-style-type: none"> <li>▪ Mass flow</li> <li>▪ Volume flow</li> <li>▪ Corrected volume flow</li> </ul>
<b>Frequency output</b>	
<b>Maximum input values</b>	DC 30 V, 250 mA (passive)
<b>Maximum output current</b>	22.5 mA (active)
<b>Open-circuit voltage</b>	DC 28.8 V (active)
<b>Output frequency</b>	Adjustable: end value frequency 2 to 10 000 Hz ( $f_{max} = 12\,500$ Hz)
<b>Damping</b>	Configurable: 0 to 999.9 s
<b>Pulse/pause ratio</b>	1:1

<b>Assignable measured variables</b>	<ul style="list-style-type: none"> <li>■ Mass flow</li> <li>■ Volume flow</li> <li>■ Corrected volume flow</li> <li>■ Density</li> <li>■ Reference density</li> <li>■ Temperature</li> <li>■ Electronics temperature</li> <li>■ Oscillation frequency 0</li> <li>■ Oscillation damping 0</li> <li>■ Signal asymmetry</li> <li>■ Exciter current 0</li> </ul> <p> The range of options increases if the measuring device has one or more application packages.</p>
<b>Switch output</b>	
<b>Maximum input values</b>	DC 30 V, 250 mA (passive)
<b>Open-circuit voltage</b>	DC 28.8 V (active)
<b>Switching behavior</b>	Binary, conductive or non-conductive
<b>Switching delay</b>	Configurable: 0 to 100 s
<b>Number of switching cycles</b>	Unlimited
<b>Assignable functions</b>	<ul style="list-style-type: none"> <li>■ Off</li> <li>■ On</li> <li>■ Diagnostic behavior</li> <li>■ Limit value                             <ul style="list-style-type: none"> <li>■ Mass flow</li> <li>■ Volume flow</li> <li>■ Corrected volume flow</li> <li>■ Density</li> <li>■ Reference density</li> <li>■ Temperature</li> <li>■ Totalizer 1-3</li> </ul> </li> <li>■ Flow direction monitoring</li> <li>■ Status                             <ul style="list-style-type: none"> <li>■ Partially filled pipe detection</li> <li>■ Low flow cut off</li> </ul> </li> </ul> <p> The range of options increases if the measuring device has one or more application packages.</p>

**Relay output**

<b>Function</b>	Switch output
<b>Version</b>	Relay output, galvanically isolated
<b>Switching behavior</b>	<p>Can be set to:</p> <ul style="list-style-type: none"> <li>■ NO (normally open), factory setting</li> <li>■ NC (normally closed)</li> </ul>



<b>Maximum switching capacity (passive)</b>	<ul style="list-style-type: none"> <li>▪ DC 30 V, 0.1 A</li> <li>▪ AC 30 V, 0.5 A</li> </ul>
<b>Assignable functions</b>	<ul style="list-style-type: none"> <li>▪ Off</li> <li>▪ On</li> <li>▪ Diagnostic behavior</li> <li>▪ Limit value                             <ul style="list-style-type: none"> <li>▪ Mass flow</li> <li>▪ Volume flow</li> <li>▪ Corrected volume flow</li> <li>▪ Density</li> <li>▪ Reference density</li> <li>▪ Temperature</li> <li>▪ Totalizer 1-3</li> </ul> </li> <li>▪ Flow direction monitoring</li> <li>▪ Status                             <ul style="list-style-type: none"> <li>▪ Partially filled pipe detection</li> <li>▪ Low flow cut off</li> </ul> </li> </ul> <p> The range of options increases if the measuring device has one or more application packages.</p>

**User-configurable input/output**

**One** specific input or output is assigned to a user-configurable input/output (configurable I/O) during device commissioning.

The following inputs and outputs are available for assignment:

- Choice of current output: 4 to 20 mA (active), 0/4 to 20 mA (passive)
- Pulse/frequency/switch output
- Choice of current input: 4 to 20 mA (active), 0/4 to 20 mA (passive)
- Status input

Signal on alarm

Depending on the interface, failure information is displayed as follows:

**PROFIBUS DP**

<b>Status and alarm messages</b>	Diagnostics in accordance with PROFIBUS PA Profile 3.02
----------------------------------	---

**Current output 0/4 to 20 mA**

*4 to 20 mA*

<b>Failure mode</b>	Choose from: <ul style="list-style-type: none"> <li>▪ 4 to 20 mA in accordance with NAMUR recommendation NE 43</li> <li>▪ 4 to 20 mA in accordance with US</li> <li>▪ Min. value: 3.59 mA</li> <li>▪ Max. value: 22.5 mA</li> <li>▪ Freely definable value between: 3.59 to 22.5 mA</li> <li>▪ Actual value</li> <li>▪ Last valid value</li> </ul>
---------------------	--

*0 to 20 mA*

<b>Failure mode</b>	Choose from: <ul style="list-style-type: none"> <li>▪ Maximum alarm: 22 mA</li> <li>▪ Freely definable value between: 0 to 20.5 mA</li> </ul>
---------------------	---

### Pulse/frequency/switch output

Pulse output	
Failure mode	Choose from: <ul style="list-style-type: none"> <li>▪ Actual value</li> <li>▪ No pulses</li> </ul>
Frequency output	
Failure mode	Choose from: <ul style="list-style-type: none"> <li>▪ Actual value</li> <li>▪ 0 Hz</li> <li>▪ Defined value (<math>f_{max}</math> 2 to 12 500 Hz)</li> </ul>
Switch output	
Failure mode	Choose from: <ul style="list-style-type: none"> <li>▪ Current status</li> <li>▪ Open</li> <li>▪ Closed</li> </ul>

### Relay output

Failure mode	Choose from: <ul style="list-style-type: none"> <li>▪ Current status</li> <li>▪ Open</li> <li>▪ Closed</li> </ul>
--------------	---

### Local display

Plain text display	With information on cause and remedial measures
Backlight	Red backlighting indicates a device error.

 Status signal as per NAMUR recommendation NE 107

### Interface/protocol



- Via digital communication:
  - PROFIBUS DP
- Via service interface
  - CDI-RJ45 service interface
  - WLAN interface

Plain text display	With information on cause and remedial measures
--------------------	---

### Web browser

Plain text display	With information on cause and remedial measures
--------------------	---

### Light emitting diodes (LED)

Status information	Status indicated by various light emitting diodes The following information is displayed depending on the device version: <ul style="list-style-type: none"> <li>▪ Supply voltage active</li> <li>▪ Data transmission active</li> <li>▪ Device alarm/error has occurred</li> </ul>  Diagnostic information via light emitting diodes →  164
--------------------	--

Low flow cut off                      The switch points for low flow cut off are user-selectable.

Galvanic isolation                      The outputs are galvanically isolated from one another and from earth (PE).

Protocol-specific data	<b>Manufacturer ID</b>	0x11
	<b>Ident number</b>	0x156F
	<b>Profile version</b>	3.02
	<b>Device description files (GSD, DTM, DD)</b>	Information and files under: <ul style="list-style-type: none"> <li>▪ <a href="http://www.endress.com">www.endress.com</a> On the product page for the device: Documents/Software → Device drivers</li> <li>▪ <a href="http://www.profibus.org">www.profibus.org</a></li> </ul>
	<b>Supported functions</b>	<ul style="list-style-type: none"> <li>▪ Identification &amp; Maintenance Simplest device identification on the part of the control system and nameplate</li> <li>▪ PROFIBUS upload/download Reading and writing parameters is up to ten times faster with PROFIBUS upload/download</li> <li>▪ Condensed status Simplest and self-explanatory diagnostic information by categorizing diagnostic messages that occur</li> </ul>
	<b>Configuration of the device address</b>	<ul style="list-style-type: none"> <li>▪ DIP switches on the I/O electronics module</li> <li>▪ Via operating tools (e.g. FieldCare)</li> </ul>
	<b>Compatibility with earlier model</b>	<p>If the device is replaced, the measuring device Promass 500 supports the compatibility of the cyclic data with previous models. It is not necessary to adjust the engineering parameters of the PROFIBUS network with the Promass 500 GSD file.</p> <p>Previous model: Promass 83 PROFIBUS DP</p> <ul style="list-style-type: none"> <li>▪ ID No.: 1529 (hex)</li> <li>▪ Extended GSD file: EH3x1529.gsd</li> <li>▪ Standard GSD file: EH3_1529.gsd</li> </ul>
	<b>System integration</b>	<p>Information regarding system integration .</p> <ul style="list-style-type: none"> <li>▪ Cyclic data transmission</li> <li>▪ Block model</li> <li>▪ Description of the modules</li> </ul>



## 16.5 Power supply

Terminal assignment                      →  40





Supply voltage	Order code for "Power supply"	Terminal voltage		Frequency range
	Option D	DC 24 V	±20%	–
Option E	AC 100 to 240 V	–15 to +10%	50/60 Hz	
Option I	DC 24 V	±20%	–	
	AC 100 to 240 V	–15 to +10%	50/60 Hz	

Power consumption                      **Transmitter**  
Max. 10 W (active power)

<b>switch-on current</b>	Max. 36 A (<5 ms) as per NAMUR Recommendation NE 21
--------------------------	---

Current consumption	<p><b>Transmitter</b></p> <ul style="list-style-type: none"> <li>▪ Max. 400 mA (24 V)</li> <li>▪ Max. 200 mA (110 V, 50/60 Hz; 230 V, 50/60 Hz)</li> </ul>
Power supply failure	<ul style="list-style-type: none"> <li>▪ Totalizers stop at the last value measured.</li> <li>▪ Depending on the device version, the configuration is retained in the device memory or in the pluggable data memory (HistoROM DAT).</li> <li>▪ Error messages (incl. total operated hours) are stored.</li> </ul>
Electrical connection	→  50
Potential equalization	→  52
Terminals	Spring-loaded terminals: Suitable for strands and strands with ferrules. Conductor cross-section 0.2 to 2.5 mm <sup>2</sup> (24 to 12 AWG).
Cable entries	<ul style="list-style-type: none"> <li>▪ Cable gland: M20 × 1.5 with cable Ø 6 to 12 mm (0.24 to 0.47 in)</li> <li>▪ Thread for cable entry: <ul style="list-style-type: none"> <li>▪ NPT ½"</li> <li>▪ G ½"</li> <li>▪ M20</li> </ul> </li> <li>▪ Device plug for digital communication: M12</li> <li>▪ Device plug for connecting cable: M12</li> </ul> <p>A device plug is always used for the device version with the order code for "Sensor connection housing", option <b>C</b> "Ultra-compact, hygienic, stainless".</p>
Cable specification	→  35

## 16.6 Performance characteristics

Reference operating conditions	<ul style="list-style-type: none"> <li>▪ Error limits based on ISO 11631</li> <li>▪ Water with +15 to +45 °C (+59 to +113 °F) at 2 to 6 bar (29 to 87 psi)</li> <li>▪ Specifications as per calibration protocol</li> <li>▪ Accuracy based on accredited calibration rigs that are traced to ISO 17025.</li> </ul> <p> To obtain measured errors, use the <i>Applicator</i> sizing tool →  238</p>
Maximum measured error	<p>o.r. = of reading; 1 g/cm<sup>3</sup> = 1 kg/l; T = medium temperature</p> <p><b>Base accuracy</b></p> <p> Design fundamentals →  251</p> <p><i>Mass flow and volume flow (liquids)</i></p> <p>±0.10 % o.r.</p>

*Density (liquids)*

Under reference conditions	Standard density calibration <sup>1)</sup>	Wide-range Density specification <sup>2) 3)</sup>
[g/cm <sup>3</sup> ]	[g/cm <sup>3</sup> ]	[g/cm <sup>3</sup> ]
±0.0005	±0.01	±0.002

- 1) Valid over the entire temperature and density range
- 2) Valid range for special density calibration: 0 to 2 g/cm<sup>3</sup>, +10 to +80 °C (+50 to +176 °F)
- 3) Order code for "Application package", option EE "Special density"

*Temperature*

$$\pm 0.5 \text{ °C} \pm 0.005 \cdot T \text{ °C} (\pm 0.9 \text{ °F} \pm 0.003 \cdot (T - 32) \text{ °F})$$

**Zero point stability**

DN		Zero point stability	
[mm]	[in]	[kg/h]	[lb/min]
8	$\frac{3}{8}$	0.20	0.007
15	$\frac{1}{2}$	0.65	0.024
25	1	1.80	0.066
40	$1\frac{1}{2}$	4.50	0.165
50	2	7.0	0.257

**Flow values**

Flow values as turndown parameter depending on nominal diameter.

*SI units*

DN	1:1	1:10	1:20	1:50	1:100	1:500
[mm]	[kg/h]	[kg/h]	[kg/h]	[kg/h]	[kg/h]	[kg/h]
8	2 000	200	100	40	20	4
15	6 500	650	325	130	65	13
25	18 000	1 800	900	360	180	36
40	45 000	4 500	2 250	900	450	90
50	70 000	7 000	3 500	1 400	700	140

*US units*

DN	1:1	1:10	1:20	1:50	1:100	1:500
[inch]	[lb/min]	[lb/min]	[lb/min]	[lb/min]	[lb/min]	[lb/min]
$\frac{3}{8}$	73.50	7.350	3.675	1.470	0.735	0.147
$\frac{1}{2}$	238.9	23.89	11.95	4.778	2.389	0.478
1	661.5	66.15	33.08	13.23	6.615	1.323
$1\frac{1}{2}$	1 654	165.4	82.70	33.08	16.54	3.308
2	2 573	257.3	128.7	51.46	25.73	5.146

**Accuracy of outputs**

The outputs have the following base accuracy specifications.

*Current output*

<b>Accuracy</b>	±5 µA
-----------------	-------



*Pulse/frequency output*

o.r. = of reading

<b>Accuracy</b>	Max. ±50 ppm o.r. (over the entire ambient temperature range)
-----------------	---

Repeatability o.r. = of reading; 1 g/cm<sup>3</sup> = 1 kg/l; T = medium temperature

**Base repeatability**

 Design fundamentals →  251

*Mass flow and volume flow (liquids)*

±0.05 % o.r.

*Density (liquids)*

±0.00025 g/cm<sup>3</sup>

*Temperature*

±0.25 °C ± 0.0025 · T °C (±0.45 °F ± 0.0015 · (T-32) °F)

Response time The response time depends on the configuration (damping).

Influence of ambient temperature

**Current output**

<b>Temperature coefficient</b>	Max. 1 µA/°C
--------------------------------	--------------

**Pulse/frequency output**

<b>Temperature coefficient</b>	No additional effect. Included in accuracy.
--------------------------------	---

Influence of medium temperature

**Mass flow and volume flow**

o.f.s. = of full scale value

When there is a difference between the temperature for zero point adjustment and the process temperature, the additional measured error of the sensor is typically ±0.0002 % o.f.s./°C (±0.0001 % o. f.s./°F).

The effect is reduced if zero point adjustment is performed at process temperature.

**Density**

When there is a difference between the density calibration temperature and the process temperature, the typical measured error of the sensor is ±0.0001 g/cm<sup>3</sup> /°C (±0.00005 g/cm<sup>3</sup> /°F). Field density calibration is possible.

**Wide-range density specification (special density calibration)**

If the process temperature is outside the valid range (→  248) the measured error is  $\pm 0.0001 \text{ g/cm}^3 / ^\circ\text{C}$  ( $\pm 0.00005 \text{ g/cm}^3 / ^\circ\text{F}$ )

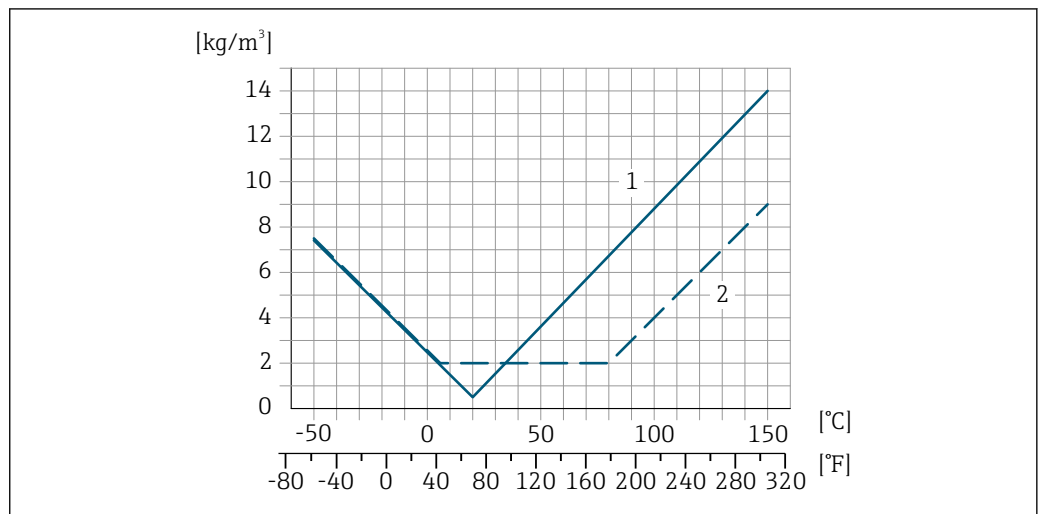

A0016611

- 1 Field density calibration, for example at +20 °C (+68 °F)
- 2 Special density calibration

**Temperature**

$\pm 0.005 \cdot T \text{ } ^\circ\text{C}$  ( $\pm 0.005 \cdot (T - 32) \text{ } ^\circ\text{F}$ )

**Influence of medium pressure**

The table below shows the effect on accuracy of mass flow due to a difference between calibration pressure and process pressure.

*o.r.* = of reading

-  It is possible to compensate for the effect by:
  - Reading in the current pressure measured value via the current input.
  - Specifying a fixed value for the pressure in the device parameters.

 Operating Instructions .

DN		[% o.r./bar]	[% o.r./psi]
[mm]	[in]		
8	3/8	-0.002	-0.0001
15	1/2	-0.006	-0.0004
25	1	-0.005	-0.0003
40	1 1/2	-0.007	-0.0005
50	2	-0.006	-0.0004

**Design fundamentals**

*o.r.* = of reading, *o.f.s.* = of full scale value

BaseAccu = base accuracy in % *o.r.*, BaseRepeat = base repeatability in % *o.r.*

MeasValue = measured value; ZeroPoint = zero point stability

Calculation of the maximum measured error as a function of the flow rate

Flow rate	Maximum measured error in % o.r.
$\geq \frac{\text{ZeroPoint}}{\text{BaseAccu}} \cdot 100$ <small>A0021332</small>	$\pm \text{BaseAccu}$ <small>A0021339</small>
$< \frac{\text{ZeroPoint}}{\text{BaseAccu}} \cdot 100$ <small>A0021333</small>	$\pm \frac{\text{ZeroPoint}}{\text{MeasValue}} \cdot 100$ <small>A0021334</small>

Calculation of the maximum repeatability as a function of the flow rate

Flow rate	Maximum repeatability in % o.r.
$\geq \frac{1/2 \cdot \text{ZeroPoint}}{\text{BaseRepeat}} \cdot 100$ <small>A0021335</small>	$\pm \text{BaseRepeat}$ <small>A0021340</small>
$< \frac{1/2 \cdot \text{ZeroPoint}}{\text{BaseRepeat}} \cdot 100$ <small>A0021336</small>	$\pm 1/2 \cdot \frac{\text{ZeroPoint}}{\text{MeasValue}} \cdot 100$ <small>A0021337</small>

Example for maximum measured error

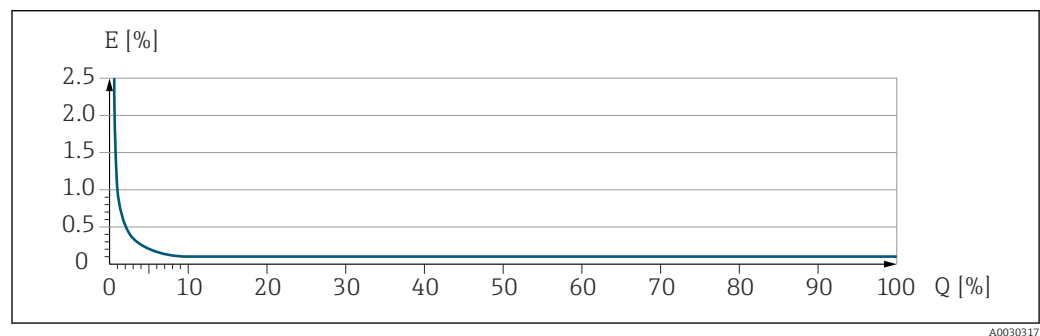

E Maximum measured error in % o.r. (example)  
 Q Flow rate in % of maximum full scale value

## 16.7 Installation

Installation conditions → 23

## 16.8 Environment



Ambient temperature range → 26 → 26

### Temperature tables

- Observe the interdependencies between the permitted ambient and fluid temperatures when operating the device in hazardous areas.
- For detailed information on the temperature tables, see the separate document entitled "Safety Instructions" (XA) for the device.

Storage temperature -50 to +80 °C (-58 to +176 °F)



Climate class	DIN EN 60068-2-38 (test Z/AD)
Degree of protection	<p><b>Transmitter</b></p> <ul style="list-style-type: none"> <li>■ As standard: IP66/67, type 4X enclosure</li> <li>■ When housing is open: IP20, type 1 enclosure</li> <li>■ Display module: IP20, type 1 enclosure</li> </ul> <p><b>Sensor</b></p> <ul style="list-style-type: none"> <li>■ As standard: IP66/67, type 4X enclosure</li> <li>■ With the order code for "Sensor options", option <b>CM</b>: IP69 can also be ordered</li> </ul> <p><b>External WLAN antenna</b> IP67</p>
Vibration- and shock-resistance	<p><b>Vibration sinusoidal, in accordance with IEC 60068-2-6</b></p> <p>Sensor</p> <ul style="list-style-type: none"> <li>■ 2 to 8.4 Hz, 3.5 mm peak</li> <li>■ 8.4 to 2 000 Hz, 1 g peak</li> </ul> <p>Transmitter</p> <ul style="list-style-type: none"> <li>■ 2 to 8.4 Hz, 7.5 mm peak</li> <li>■ 8.4 to 2 000 Hz, 2 g peak</li> </ul> <p><b>Vibration broad-band random, according to IEC 60068-2-64</b></p> <p>Sensor</p> <ul style="list-style-type: none"> <li>■ 10 to 200 Hz, 0.003 g<sup>2</sup>/Hz</li> <li>■ 200 to 2 000 Hz, 0.001 g<sup>2</sup>/Hz</li> <li>■ Total: 1.54 g rms</li> </ul> <p>Transmitter</p> <ul style="list-style-type: none"> <li>■ 10 to 200 Hz, 0.01 g<sup>2</sup>/Hz</li> <li>■ 200 to 2 000 Hz, 0.003 g<sup>2</sup>/Hz</li> <li>■ Total: 2.70 g rms</li> </ul> <p><b>Shock half-sine, according to IEC 60068-2-27</b></p> <ul style="list-style-type: none"> <li>■ Sensor 6 ms 30 g</li> <li>■ Transmitter 6 ms 50 g</li> </ul> <p><b>Rough handling shocks, according to IEC 60068-2-31</b></p>
Mechanical load	Never use the transmitter housing as a ladder or climbing aid.
Electromagnetic compatibility (EMC)	<ul style="list-style-type: none"> <li>■ As per IEC/EN 61326 and NAMUR Recommendation 21 (NE 21)</li> <li>■ Device version with PROFIBUS DP: Complies with emission limits for industry as per EN 50170 Volume 2, IEC 61784</li> </ul> <p> The following applies for PROFIBUS DP: If baud rates &gt; 1.5 Mbaud, an EMC cable entry must be used and the cable shield must continue as far as the terminal wherever possible.</p> <p> Details are provided in the Declaration of Conformity.</p>

## 16.9 Process

Medium temperature range -50 to +150 °C (-58 to +302 °F)

### Dependency of ambient temperature on medium temperature

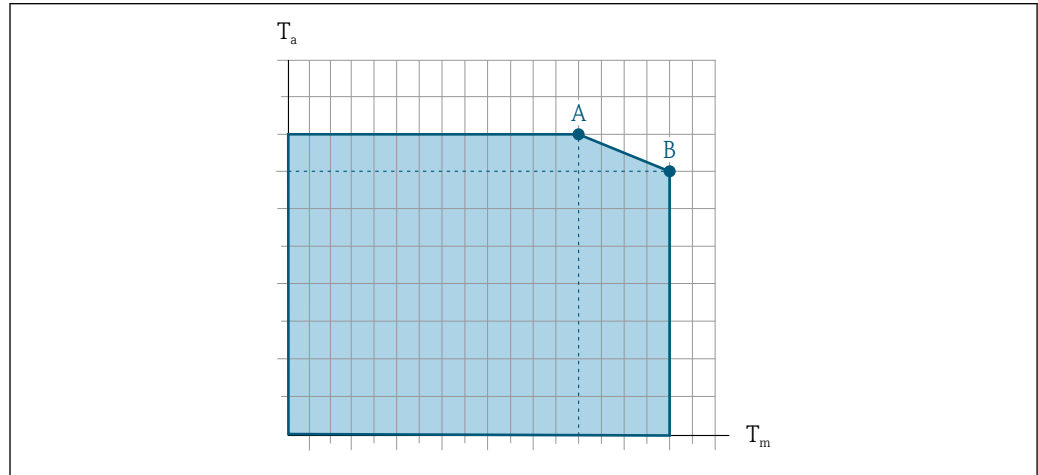

A0031121

39 Exemplary representation, values in the table below.

$T_a$  Ambient temperature range

$T_m$  Medium temperature

A Maximum permitted medium temperature  $T_m$  at  $T_{a\ max} = 60\ \text{°C}$  (140 °F); higher medium temperatures  $T_m$  require a reduced ambient temperature  $T_a$

B Maximum permitted ambient temperature  $T_a$  for the maximum specified medium temperature  $T_m$  of the sensor

**i** Values for devices used in the hazardous area:  
Separate Ex documentation (XA) for the device → 267.

Version	Not insulated				Insulated			
	A		B		A		B	
	$T_a$	$T_m$	$T_a$	$T_m$	$T_a$	$T_m$	$T_a$	$T_m$
Promass S 500 – digital	60 °C (140 °F)	150 °C (302 °F)	-	-	60 °C (140 °F)	90 °C (194 °F)	45 °C (113 °F)	150 °C (302 °F)
Promass S 500								

Density 0 to 5 000 kg/m<sup>3</sup> (0 to 312 lb/cf)

Pressure-temperature ratings **i** An overview of the pressure-temperature ratings for the process connections is provided in the "Technical Information" document

Sensor housing The sensor housing is filled with dry nitrogen gas and protects the electronics and mechanics inside.

**i** If a measuring tube fails (e.g. due to process characteristics like corrosive or abrasive fluids), the fluid will initially be contained by the sensor housing.

If the sensor is to be purged with gas (gas detection), it should be equipped with purge connections.

 Do not open the purge connections unless the containment can be filled immediately with a dry, inert gas. Use only low pressure to purge.

Maximum pressure: 5 bar (72.5 psi)

### Burst pressure of the sensor housing

The following sensor housing burst pressures are only valid for standard devices and/or devices equipped with closed purge connections (not opened/as delivered).

If a device fitted with purge connections (order code for "Sensor option", option CH "Purge connection") is connected to the purge system, the maximum pressure is determined by the purge system itself or by the device, depending on which component has the lower pressure classification.



The sensor housing burst pressure refers to a typical internal pressure which is reached prior to mechanical failure of the sensor housing and which was determined during type testing. The corresponding type test declaration can be ordered with the device (order code for "Additional approval", option LN "Sensor housing burst pressure, type test").

DN		Sensor housing burst pressure	
[mm]	[in]	[bar]	[psi]
8	$\frac{3}{8}$	190	2 755
15	$\frac{1}{2}$	175	2 538
25	1	165	2 392
40	$1\frac{1}{2}$	152	2 204
50	2	103	1 494



 For information on the dimensions: see the "Mechanical construction" section of the "Technical Information" document

### Flow limit



Select the nominal diameter by optimizing between the required flow range and permissible pressure loss.

 For an overview of the full scale values for the measuring range, see the "Measuring range" section →  240

- The minimum recommended full scale value is approx. 1/20 of the maximum full scale value
- In most applications, 20 to 50 % of the maximum full scale value can be considered ideal
- A low full scale value must be selected for abrasive media (such as liquids with entrained solids): flow velocity < 1 m/s (< 3 ft/s).

 To calculate the flow limit, use the *Applicator* sizing tool →  238

### Pressure loss

 To calculate the pressure loss, use the *Applicator* sizing tool →  238

### System pressure

→  26

## 16.10 Mechanical construction

Design, dimensions



For the dimensions and installation lengths of the device, see the "Technical Information" document, "Mechanical construction" section.

Weight

All values (weight exclusive of packaging material) refer to devices with EN/DIN PN 40 flanges.

**Transmitter**

- Proline 500 – digital polycarbonate: 1.4 kg (3.1 lbs)
- Proline 500 – digital aluminum: 2.4 kg (5.3 lbs)
- Proline 500 aluminum: 6.5 kg (14.3 lbs)

**Sensor**

Sensor with aluminum connection housing version: see the information in the following table

**Weight in SI units**

DN [mm]	Weight [kg]
8	11
15	13
25	19
40	35
50	58

**Weight in US units**

DN [in]	Weight [lbs]
3/8	24
1/2	29
1	42
1 1/2	77
2	128

Materials

**Transmitter housing**

*Housing of Proline 500 – digital transmitter*

Order code for "Transmitter housing":

- Option **A** "Aluminum coated": aluminum, AlSi10Mg, coated
- Option **D** "Polycarbonate": polycarbonate

*Housing of Proline 500 transmitter*

Order code for "Transmitter housing":

Option **A** "Aluminum coated": aluminum, AlSi10Mg, coated

*Window material*

Order code for "Transmitter housing":

- Option **A** "Aluminum, coated": glass
- Option **D** "Polycarbonate": plastic

*Fastening components for mounting on a post*

- Screws, threaded bolts, washers, nuts: stainless A2 (chrome-nickel steel)
- Metal plates: stainless steel, 1.4301 (304)

**Sensor connection housing**

Order code for "Sensor connection housing":

- Option **A** "Aluminum coated": aluminum, AlSi10Mg, coated
- Option **B** "Stainless":
  - Stainless steel 1.4301 (304)
  - Optional: Order code for "Sensor feature", option **CC** "Hygienic version, for maximum corrosion resistance": stainless steel, 1.4404 (316L)
- Option **C** "Ultra-compact, stainless":
  - Stainless steel 1.4301 (304)
  - Optional: Order code for "Sensor feature", option **CC** "Hygienic version, for maximum corrosion resistance": stainless steel, 1.4404 (316L)

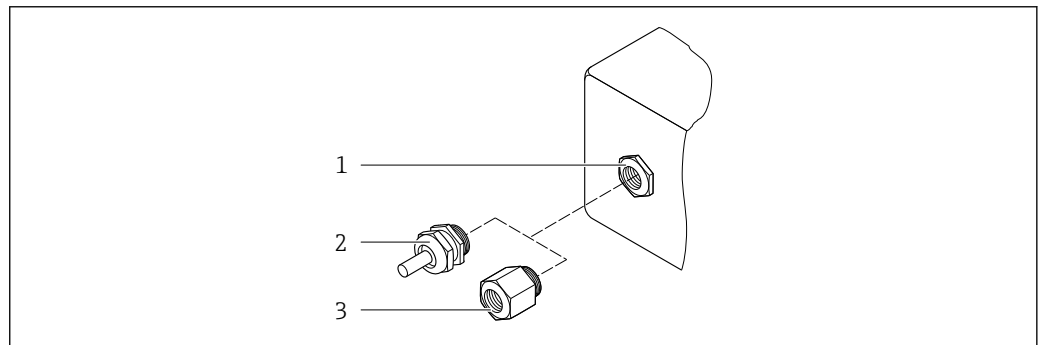
**Cable entries/cable glands**

A0020640

40 Possible cable entries/cable glands

- 1 Female thread M20 × 1.5
- 2 Cable gland M20 × 1.5
- 3 Adapter for cable entry with female thread G ½" or NPT ½"

Cable entries and adapters	Material
Cable gland M20 × 1.5	Plastic
<ul style="list-style-type: none"> <li>▪ Adapter for cable entry with female thread G ½"</li> <li>▪ Adapter for cable entry with female thread NPT ½"</li> </ul> <p><b>i</b> Only available for certain device versions:</p> <ul style="list-style-type: none"> <li>▪ Order code for "Transmitter housing":               <ul style="list-style-type: none"> <li>▪ Option A "Aluminum, coated"</li> <li>▪ Option D "Polycarbonate"</li> </ul> </li> <li>▪ Order code for "Sensor connection housing":               <ul style="list-style-type: none"> <li>▪ Proline 500 – digital:                   <ul style="list-style-type: none"> <li>Option A "Aluminum coated"</li> <li>Option B "Stainless"</li> </ul> </li> <li>▪ Proline 500:                   <ul style="list-style-type: none"> <li>Option B "Stainless"</li> </ul> </li> </ul> </li> </ul>	Nickel-plated brass

**Connecting cable**

- i** UV rays can impair the cable outer sheath. Protect the cable from exposure to sun as much as possible.

*Connecting cable for sensor - Proline 500 – digital transmitter*

PVC cable with copper shield

*Connecting cable for sensor - Proline 500 transmitter*

- Standard cable: PVC cable with copper shield
- Armored cable: PVC cable with copper shield and additional steel wire braided jacket

**Sensor housing**



- Acid and alkali-resistant outer surface
- Stainless steel 1.4301 (304)

**Measuring tubes**

Stainless steel, 1.4435 (316L)

**Process connections**

<b>Flange according to EN 1092-1 (DIN 2501)/ASME B16.5/JIS B2220:</b>	Stainless steel, 1.4404 (316/316L)
<b>All other process connections:</b>	Stainless steel, 1.4435 (316L)

 Available process connections →  259

**Seals**

Welded process connections without internal seals



**Accessories**

*Protective cover*

Stainless steel, 1.4404 (316L)

*External WLAN antenna*



- Antenna: ASA plastic (acrylic ester-styrene-acrylonitrile) and nickel-plated brass
- Adapter: Stainless steel and nickel-plated brass
- Cable: Polyethylene
- Plug: Nickel-plated brass
- Angle bracket: Stainless steel

Process connections	<ul style="list-style-type: none"> <li>■ Fixed flange connections: <ul style="list-style-type: none"> <li>■ EN 1092-1 (DIN 2501) flange</li> <li>■ EN 1092-1 (DIN 2512N) flange</li> <li>■ ASME B16.5 flange</li> <li>■ JIS B2220 flange</li> <li>■ DIN 11864-2 Form A flange, DIN 11866 series A, flange with notch</li> </ul> </li> <li>■ Clamp connections: <ul style="list-style-type: none"> <li>■ Tri-Clamp (OD tubes), DIN 11866 series C</li> <li>■ DIN 11864-3 Form A clamp, DIN 11866 series A, with notch</li> <li>■ DIN 32676 clamp, DIN 11866 series A</li> <li>■ ISO 2852 clamp, ISO 2037</li> </ul> </li> <li>■ Thread: <ul style="list-style-type: none"> <li>■ DIN 11851 thread, DIN 11866 series A</li> <li>■ SMS 1145 thread</li> <li>■ ISO 2853 thread, ISO 2037</li> <li>■ DIN 11864-1 Form A thread, DIN 11866 series A</li> </ul> </li> </ul> <p> Process connection materials →  258</p>
---------------------	--

Surface roughness	<p>All data relate to parts in contact with fluid. The following surface roughness quality can be ordered.</p> <ul style="list-style-type: none"> <li>■ <math>Ra_{max} = 0.76 \mu\text{m}</math> (30 <math>\mu\text{in}</math>)</li> <li>■ <math>Ra_{max} = 0.38 \mu\text{m}</math> (15 <math>\mu\text{in}</math>)</li> </ul>
-------------------	---

## 16.11 Human interface

Languages	<p>Can be operated in the following languages:</p> <ul style="list-style-type: none"> <li>■ Via local operation English, German, French, Spanish, Italian, Dutch, Portuguese, Polish, Russian, Turkish, Chinese, Japanese, Korean, Bahasa (Indonesian), Vietnamese, Czech, Swedish</li> <li>■ Via Web browser English, German, French, Spanish, Italian, Dutch, Portuguese, Polish, Russian, Turkish, Chinese, Japanese, Korean, Bahasa (Indonesian), Vietnamese, Czech, Swedish</li> <li>■ Via "FieldCare", "DeviceCare" operating tool: English, German, French, Spanish, Italian, Chinese, Japanese</li> </ul>
-----------	---

Local operation	<p><b>Via display module</b></p> <p>Equipment:</p> <ul style="list-style-type: none"> <li>■ Order code for "Display; operation", option F "4-line, illuminated, graphic display; touch control"</li> <li>■ Order code for "Display; operation", option G "4-line, illuminated, graphic display; touch control + WLAN"</li> </ul> <p> Information about WLAN interface →  83</p>
-----------------	--

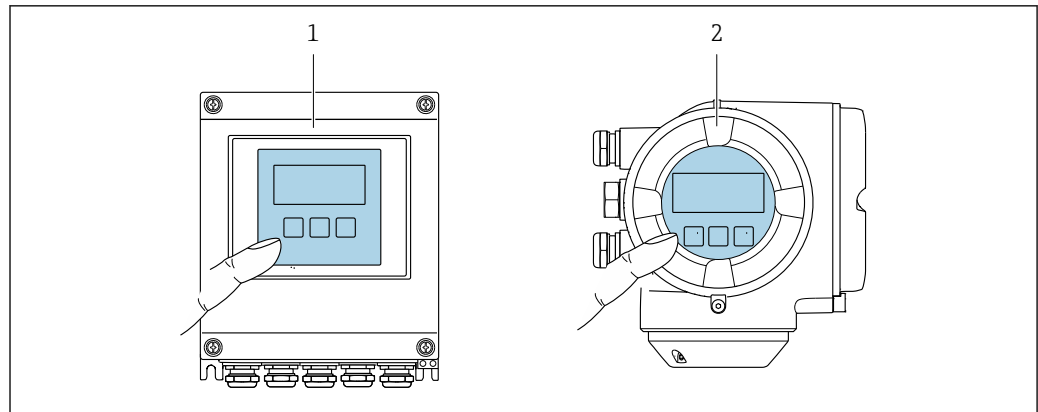

A0028232



41 Operation with touch control

- 1 Proline 500 – digital
- 2 Proline 500

Display elements

- 4-line, illuminated, graphic display
- White background lighting; switches to red in event of device errors
- Format for displaying measured variables and status variables can be individually configured
- Permitted ambient temperature for the display: -20 to +60 °C (-4 to +140 °F)  
The readability of the display may be impaired at temperatures outside the temperature range.

Operating elements



- External operation via touch control (3 optical keys) without opening the housing: , , 
- Operating elements also accessible in the various zones of the hazardous area

Remote operation →  82

Service interface →  82

Supported operating tools Different operating tools can be used for local or remote access to the measuring device. Depending on the operating tool used, access is possible with different operating units and via a variety of interfaces.



Supported operating tools	Operating unit	Interface	Additional information
Web browser	Notebook, PC or tablet with Web browser	<ul style="list-style-type: none"> <li>■ CDI-RJ45 service interface</li> <li>■ WLAN interface</li> </ul>	Special Documentation for device →  267
DeviceCare SFE100	Notebook, PC or tablet with Microsoft Windows system	<ul style="list-style-type: none"> <li>■ CDI-RJ45 service interface</li> <li>■ WLAN interface</li> <li>■ Fieldbus protocol</li> </ul>	→  238
FieldCare SFE500	Notebook, PC or tablet with Microsoft Windows system	<ul style="list-style-type: none"> <li>■ CDI-RJ45 service interface</li> <li>■ WLAN interface</li> <li>■ Fieldbus protocol</li> </ul>	→  238

 Other operating tools based on FDT technology with a device driver such as DTM/iDTM or DD/EDD can be used for device operation. These operating tools are available from the individual manufacturers. Integration into the following operating tools, among others, is supported:

- Field Device Manager (FDM) by Honeywell → [www.honeywellprocess.com](http://www.honeywellprocess.com)
- FieldMate by Yokogawa → [www.yokogawa.com](http://www.yokogawa.com)
- PACTWare → [www.pactware.com](http://www.pactware.com)

The associated device description files are available at: [www.endress.com](http://www.endress.com) → Downloads

### Web server



Thanks to the integrated Web server, the device can be operated and configured via a Web browser and via a service interface (CDI-RJ45) or via a WLAN interface. The structure of the operating menu is the same as for the local display. In addition to the measured values, status information on the device is also displayed and allows the user to monitor the status of the device. Furthermore the device data can be managed and the network parameters can be configured.

A device that has a WLAN interface (can be ordered as an option) is required for the WLAN connection: order code for "Display; operation", option G "4-line, illuminated; touch control + WLAN". The device acts as an Access Point and enables communication by computer or a mobile handheld terminal.

#### Supported functions

Data exchange between the operating unit (such as a notebook for example) and the measuring device:

- Upload the configuration from the measuring device (XML format, configuration backup)
- Save the configuration to the measuring device (XML format, restore configuration)
- Export event list (.csv file)
- Export parameter settings (.csv file or PDF file, document the measuring point configuration)
- Export the Heartbeat verification log (PDF file, only available with the "Heartbeat Verification" application package)
- Flash firmware version for device firmware upgrade, for instance
- Download driver for system integration
- Visualize up to 1000 saved measured values (only available with the **Extended HistoROM** application package →  265)

 Web server special documentation →  267

HistoROM data management

The measuring device features HistoROM data management. HistoROM data management comprises both the storage and import/export of key device and process data, making operation and servicing far more reliable, secure and efficient.

 When the device is delivered, the factory settings of the configuration data are stored as a backup in the device memory. This memory can be overwritten with an updated data record, for example after commissioning.

**Additional information on the data storage concept**

*There are different types of data storage units in which device data are stored and used by the device:*

	Device memory	T-DAT	S-DAT
<b>Available data</b>	<ul style="list-style-type: none"> <li>▪ Event logbook such as diagnostic events for example</li> <li>▪ Parameter data record backup</li> <li>▪ Device firmware package</li> <li>▪ Driver for system integration for exporting via Web server, e.g: GSD for PROFIBUS DP</li> </ul>	<ul style="list-style-type: none"> <li>▪ Measured value logging ("Extended HistoROM" order option)</li> <li>▪ Current parameter data record (used by firmware at run time)</li> <li>▪ Peakhold indicator (min/max values)</li> <li>▪ Totalizer values</li> </ul>	<ul style="list-style-type: none"> <li>▪ Sensor data: nominal diameter etc.</li> <li>▪ Serial number</li> <li>▪ Calibration data</li> <li>▪ Device configuration (e.g. SW options, fixed I/O or multi I/O)</li> </ul>
<b>Storage location</b>	Fixed on the user interface board in the connection compartment	Attachable to the user interface board in the connection compartment	In the sensor plug in the transmitter neck part

**Data backup**

**Automatic**

- The most important device data (sensor and transmitter) are automatically saved in the DAT modules
- If the transmitter or measuring device is replaced: once the T-DAT containing the previous device data has been exchanged, the new measuring device is ready for operation again immediately without any errors
- If the sensor is replaced: once the sensor has been replaced, new sensor data are transferred from the S-DAT in the measuring device and the measuring device is ready for operation again immediately without any errors
- If exchanging the electronics module (e.g. I/O electronics module): Once the electronics module has been replaced, the software of the module is compared against the current device firmware. The module software is upgraded or downgraded where necessary. The electronics module is available for use immediately afterwards and no compatibility problems occur.

**Manual**

Additional parameter data record (complete parameter settings) in the integrated device memory HistoROM backup for:

- Data backup function  
Backup and subsequent restoration of a device configuration in the device memory HistoROM backup
- Data comparison function  
Comparison of the current device configuration with the device configuration saved in the device memory HistoROM backup

**Data transfer**

**Manual**

- Transfer of a device configuration to another device using the export function of the specific operating tool, e.g. with FieldCare, DeviceCare or Web server: to duplicate the configuration or to store in an archive (e.g. for backup purposes)
- Transmission of the drivers for system integration via Web server, e.g.: GSD for PROFIBUS DP

**Event list****Automatic**

- Chronological display of up to 20 event messages in the events list
- If the **Extended HistoROM** application package (order option) is enabled: up to 100 event messages are displayed in the events list along with a time stamp, plain text description and remedial measures
- The events list can be exported and displayed via a variety of interfaces and operating tools e.g. DeviceCare, FieldCare or Web server

**Data logging****Manual**



If the **Extended HistoROM** application package (order option) is enabled:

- Record up to 1 000 measured values via 1 to 4 channels
- User configurable recording interval
- Record up to 250 measured values via each of the 4 memory channels
- Export the measured value log via a variety of interfaces and operating tools e.g. FieldCare, DeviceCare or web server

**16.12 Certificates and approvals**

 Currently available certificates and approvals can be called up via the product configurator.

CE mark	<p>The device meets the legal requirements of the applicable EU Directives. These are listed in the corresponding EU Declaration of Conformity along with the standards applied.</p> <p>Endress+Hauser confirms successful testing of the device by affixing to it the CE mark.</p>
RCM-tick symbol	<p>The measuring system meets the EMC requirements of the "Australian Communications and Media Authority (ACMA)".</p>
Ex approval	<p>The devices are certified for use in hazardous areas and the relevant safety instructions are provided in the separate "Safety Instructions" (XA) document. Reference is made to this document on the nameplate.</p>
Sanitary compatibility	<ul style="list-style-type: none"> <li>■ 3-A approval           <ul style="list-style-type: none"> <li>■ Only measuring devices with the order code for "Additional approval", option LP "3A" have 3-A approval.</li> <li>■ The 3-A approval refers to the measuring device.</li> <li>■ When installing the measuring device, ensure that no liquid can accumulate on the outside of the measuring device. Remote transmitters must be installed in accordance with the 3-A Standard.</li> <li>■ Accessories (e.g. heating jacket, weather protection cover, wall holder unit) must be installed in accordance with the 3-A Standard. Each accessory can be cleaned. Disassembly may be necessary under certain circumstances.</li> </ul> </li> <li>■ EHEDG-tested Only devices with the order code for "Additional approval", option LT "EHEDG" have been tested and meet the requirements of the EHEDG. To meet the requirements for EHEDG certification, the device must be used with process connections in accordance with the EHEDG position paper entitled "Easy Cleanable Pipe Couplings and Process Connections" (<a href="http://www.ehedg.org">www.ehedg.org</a>).</li> <li>■ FDA</li> <li>■ Food Contact Materials Regulation (EC) 1935/2004</li> </ul>



<p>Pharmaceutical compatibility</p>	<ul style="list-style-type: none"> <li>■ FDA 21 CFR 177</li> <li>■ USP &lt;87&gt;</li> <li>■ USP &lt;88&gt; Class VI 121 °C</li> <li>■ TSE/BSE Certificate of Suitability</li> <li>■ cGMP</li> </ul> <p> Devices with order code for "Test, certificate", option JG "Compliance with requirements derived from cGMP, declaration" are in accordance with cGMP requirements relating to the surfaces of wetted parts, design, FDA 21 CFR material conformity, USP Class VI tests and TSE/BSE-compliance.</p> <p>A manufacturer's declaration specific to the serial number is supplied with the device.</p>
<p>Certification PROFIBUS</p>	<p><b>PROFIBUS interface</b></p> <p>The measuring device is certified and registered by the PNO (PROFIBUS User Organization Organization). The measuring system meets all the requirements of the following specifications:</p> <ul style="list-style-type: none"> <li>■ Certified in accordance with PROFIBUS PA Profile 3.02</li> <li>■ The device can also be operated with certified devices of other manufacturers (interoperability)</li> </ul>
<p>Pressure Equipment Directive</p>	<ul style="list-style-type: none"> <li>■ With the identification PED/G1/x (x = category) on the sensor nameplate, Endress+Hauser confirms conformity with the "Essential Safety Requirements" specified in Appendix I of the Pressure Equipment Directive 2014/68/EU.</li> <li>■ Devices not bearing this marking (PED) are designed and manufactured according to good engineering practice. They meet the requirements of Article 4 paragraph 3 of the Pressure Equipment Directive 2014/68/EU. The range of application is indicated in tables 6 to 9 in Annex II of the Pressure Equipment Directive 2014/68/EU.</li> </ul>
<p>Radio approval</p>	<p>The measuring device has radio approval.</p> <p> For detailed information regarding radio approval, see Special Documentation →  267</p>
<p>Additional certification</p>	<p><b>CRN approval</b></p> <p>Some device versions have CRN approval. A CRN-approved process connection with a CSA approval must be ordered for a CRN-approved device.</p> <p><b>Tests and certificates</b></p> <ul style="list-style-type: none"> <li>■ EN10204-3.1 material certificate, parts and sensor housing in contact with medium</li> <li>■ Pressure testing, internal procedure, inspection certificate</li> <li>■ PMI test (XRF), internal procedure, wetted parts, test report</li> <li>■ Compliance with requirements derived from cGMP, Declaration</li> <li>■ EN10204-2.1 confirmation of compliance with the order and EN10204-2.2 test report</li> </ul>
<p>Other standards and guidelines</p>	<ul style="list-style-type: none"> <li>■ EN 60529 Degrees of protection provided by enclosures (IP code)</li> <li>■ IEC/EN 60068-2-6 Environmental influences: Test procedure - Test Fc: vibrate (sinusoidal).</li> <li>■ IEC/EN 60068-2-31 Environmental influences: Test procedure - Test Ec: shocks due to rough handling, primarily for devices.</li> <li>■ EN 61010-1 Safety requirements for electrical equipment for measurement, control and laboratory use - general requirements</li> </ul>

- IEC/EN 61326  
Emission in accordance with Class A requirements. Electromagnetic compatibility (EMC requirements).
- NAMUR NE 21  
Electromagnetic compatibility (EMC) of industrial process and laboratory control equipment
- NAMUR NE 32  
Data retention in the event of a power failure in field and control instruments with microprocessors
- NAMUR NE 43  
Standardization of the signal level for the breakdown information of digital transmitters with analog output signal.
- NAMUR NE 53  
Software of field devices and signal-processing devices with digital electronics
- NAMUR NE 80  
The application of the pressure equipment directive to process control devices
- NAMUR NE 105  
Specifications for integrating fieldbus devices in engineering tools for field devices
- NAMUR NE 107  
Self-monitoring and diagnosis of field devices
- NAMUR NE 131  
Requirements for field devices for standard applications
- NAMUR NE 132  
Coriolis mass meter

## 16.13 Application packages

Many different application packages are available to enhance the functionality of the device. Such packages might be needed to address safety aspects or specific application requirements.

The application packages can be ordered with the device or subsequently from Endress+Hauser. Detailed information on the order code in question is available from your local Endress+Hauser sales center or on the product page of the Endress+Hauser website: [www.endress.com](http://www.endress.com).

 Detailed information on the application packages:  
Special Documentation for the device →  267

### Diagnostics functions



Package	Description
Extended HistoROM	<p>Comprises extended functions concerning the event log and the activation of the measured value memory.</p> <p>Event log: Memory volume is extended from 20 message entries (standard version) to up to 100 entries.</p> <p>Data logging (line recorder):</p> <ul style="list-style-type: none"> <li>▪ Memory capacity for up to 1000 measured values is activated.</li> <li>▪ 250 measured values can be output via each of the 4 memory channels. The recording interval can be defined and configured by the user.</li> <li>▪ Measured value logs can be accessed via the local display or operating tool e.g. FieldCare, DeviceCare or Web server.</li> </ul>

Package	Description
Heartbeat Verification +Monitoring	<p><b>Heartbeat Verification</b> Meets the requirement for traceable verification to DIN ISO 9001:2008 Chapter 7.6 a) "Control of monitoring and measuring equipment".</p> <ul style="list-style-type: none"> <li>■ Functional testing in the installed state without interrupting the process.</li> <li>■ Traceable verification results on request, including a report.</li> <li>■ Simple testing process via local operation or other operating interfaces.</li> <li>■ Clear measuring point assessment (pass/fail) with high test coverage within the framework of manufacturer specifications.</li> <li>■ Extension of calibration intervals according to operator's risk assessment.</li> </ul> <p><b>Heartbeat Monitoring</b> Continuously supplies data, which are characteristic of the measuring principle, to an external condition monitoring system for the purpose of preventive maintenance or process analysis. These data enable the operator to:</p> <ul style="list-style-type: none"> <li>■ Draw conclusions - using these data and other information - about the impact process influences (such as corrosion, abrasion, buildup etc.) have on the measuring performance over time.</li> <li>■ Schedule servicing in time.</li> <li>■ Monitor the process or product quality, e.g. gas pockets.</li> </ul>

Package	Description
Concentration	<p><b>Calculation and outputting of fluid concentrations</b> The measured density is converted to the concentration of a substance of a binary mixture using the "Concentration" application package:</p> <ul style="list-style-type: none"> <li>■ Choice of predefined fluids (e.g. various sugar solutions, acids, alkalis, salts, ethanol etc.)</li> <li>■ Common or user-defined units (°Brix, °Plato, % mass, % volume, mol/l etc.) for standard applications.</li> <li>■ Concentration calculation from user-defined tables.</li> </ul>

Package	Description
Special density	<p>Many applications use density as a key measured value for monitoring quality or controlling processes. The device measures the density of the fluid as standard and makes this value available to the control system. The "Special Density" application package offers high-precision density measurement over a wide density and temperature range particularly for applications subject to varying process conditions.</p>

## 16.14 Accessories

 Overview of accessories available for order →  236

## 16.15 Supplementary documentation

 For an overview of the scope of the associated Technical Documentation, refer to the following:

- *W@M Device Viewer* ([www.endress.com/deviceviewer](http://www.endress.com/deviceviewer)): Enter the serial number from nameplate
- *Endress+Hauser Operations App*: Enter the serial number from the nameplate or scan the 2D matrix code (QR code) on the nameplate

Standard documentation **Brief Operating Instructions***Brief Operating Instructions for the sensor*

Measuring device	Documentation code
Proline Promass S	KA01287D

*Brief Operating Instructions for transmitter*

Measuring device	Documentation code
Proline 500 – digital	KA01390D
Proline 500	KA01389D

**Technical Information**

Measuring device	Documentation code
Promass S 500	TI01288D

**Description of Device Parameters**

Measuring device	Documentation code
Promass 500	GP01137D

Device-dependent  
additional documentation**Safety instructions**

Safety instructions for electrical equipment for hazardous areas.

Contents	Documentation code
	Measuring device
ATEX/IECEX Ex i	XA01473D
ATEX/IECEX Ex ec	XA01474D
cCSAus IS	XA01475D
cCSAus Ex i	XA01509D
cCSAus Ex nA	XA01510D
INMETRO Ex i	XA01476D
INMETRO Ex ec	XA01477D
NEPSI Ex i	XA01478D
NEPSI Ex nA	XA01479D
NEPSI Ex i	XA01658D
NEPSI Ex nA	XA01659D
JPN	XA01780D

**Special Documentation**

Contents	Documentation code
Information on the Pressure Equipment Directive	SD01614D
Radio approvals for WLAN interface for A309/A310 display module	SD01793D
Web server	SD02232D

Contents	Documentation code
Heartbeat Technology	SD02203D
Concentration measurement	SD02213D

### Installation Instructions

Contents	Comment
Installation instructions for spare part sets and accessories	<ul style="list-style-type: none"> <li>▪ Access the overview of all the available spare part sets via <i>W@M Device Viewer</i> → 📄 234</li> <li>▪ Accessories available for order with Installation Instructions → 📄 236</li> </ul>



# Index

## 0 ... 9

3-A approval . . . . . 263

## A

Access authorization to parameters  
 Read access . . . . . 74  
 Write access . . . . . 74  
 Access code . . . . . 74  
 Incorrect input . . . . . 74  
 Accuracy . . . . . 248  
 Adapting the diagnostic behavior . . . . . 172  
 Additional certification . . . . . 264  
 Ambient temperature  
 Influence . . . . . 250  
 Analog Input module . . . . . 93  
 Analog Output module . . . . . 96  
 Application . . . . . 239  
 Application packages . . . . . 265  
 Approvals . . . . . 263

## C

Cable entries  
 Technical data . . . . . 248  
 Cable entry  
 Degree of protection . . . . . 60  
 CE mark . . . . . 11, 263  
 Certificates . . . . . 263  
 Certification PROFIBUS . . . . . 264  
 cGMP . . . . . 264  
 Check  
 Installation . . . . . 34  
 Checklist  
 Post-connection check . . . . . 60  
 Post-installation check . . . . . 34  
 Cleaning  
 Cleaning in place (CIP) . . . . . 233  
 Exterior cleaning . . . . . 233  
 Interior cleaning . . . . . 233  
 Sterilization in place (SIP) . . . . . 233  
 Climate class . . . . . 253  
 Commissioning . . . . . 102  
 Advanced settings . . . . . 131  
 Configuring the measuring device . . . . . 103  
 Compatibility with earlier model . . . . . 88  
 Connecting cable . . . . . 35  
 Connecting the connecting cable  
 Proline 500 – digital transmitter . . . . . 47  
 Proline 500 terminal assignment . . . . . 50  
 Proline 500 transmitter . . . . . 52  
 Sensor connection housing, Proline 500 . . . . . 50  
 Sensor connection housing, Proline 500 - digital . . . . . 43  
 Terminal assignment of Proline 500 - digital . . . . . 43  
 Connecting the measuring device  
 Proline 500 . . . . . 50  
 Proline 500 – digital . . . . . 43

Connecting the signal cable/supply voltage cable  
 Proline 500 – digital transmitter . . . . . 48  
 Connection  
 see Electrical connection  
 Connection preparations . . . . . 41  
 Connection tools . . . . . 35  
 Context menu  
 Calling up . . . . . 70  
 Closing . . . . . 70  
 Explanation . . . . . 70  
 Current consumption . . . . . 248  
 Cyclic data transmission . . . . . 92

## D

Declaration of Conformity . . . . . 11  
 Define access code . . . . . 146  
 Degree of protection . . . . . 60, 253  
 Density . . . . . 254  
 Design fundamentals  
 Maximum measured error . . . . . 251  
 Repeatability . . . . . 251  
 Designated use . . . . . 10  
 Device components . . . . . 15  
 Device description files . . . . . 88  
 Device documentation  
 Supplementary documentation . . . . . 8  
 Device locking, status . . . . . 150  
 Device master file  
 GSD . . . . . 88  
 Device name  
 Sensor . . . . . 20  
 Transmitter . . . . . 18  
 Device repair . . . . . 234  
 Device revision . . . . . 88  
 Device type ID . . . . . 88  
 DeviceCare . . . . . 86  
 Device description file . . . . . 88  
 Diagnostic behavior  
 Explanation . . . . . 168  
 Symbols . . . . . 168  
 Diagnostic information  
 Design, description . . . . . 168, 171  
 DeviceCare . . . . . 170  
 FieldCare . . . . . 170  
 Light emitting diodes . . . . . 164  
 Local display . . . . . 167  
 Overview . . . . . 175  
 Remedial measures . . . . . 175  
 Web browser . . . . . 169  
 Diagnostic list . . . . . 226  
 Diagnostic message . . . . . 167  
 Diagnostics  
 Symbols . . . . . 167  
 DIP switch  
 see Write protection switch  
 Direct access . . . . . 72

- Direct access code . . . . . 66
  - Disabling write protection . . . . . 146
  - Discrete Input module . . . . . 96
  - Discrete Output module . . . . . 97
  - Display
    - see Onsite display
  - Display area
    - For operational display . . . . . 65
    - In the navigation view . . . . . 67
  - Display values
    - For locking status . . . . . 150
  - Disposal . . . . . 235
  - Document
    - Function . . . . . 6
    - Symbols . . . . . 6
  - Document function . . . . . 6
  - Down pipe . . . . . 24
- E**
- Editing view . . . . . 68
    - Input screen . . . . . 69
    - Using operating elements . . . . . 68, 69
  - EHDEG-certified . . . . . 263
  - Electrical connection
    - Degree of protection . . . . . 60
    - Measuring device . . . . . 35
    - Operating tools
      - Via PROFIBUS DP network . . . . . 82
      - Via service interface (CDI-RJ45) . . . . . 82
      - Via WLAN interface . . . . . 83
    - Web server . . . . . 82
    - WLAN interface . . . . . 83
  - Electromagnetic compatibility . . . . . 253
  - Electronics module . . . . . 15
  - EMPTY\_MODULE module . . . . . 98
  - Enabling write protection . . . . . 146
  - Enabling/disabling the keypad lock . . . . . 75
  - Endress+Hauser services
    - Maintenance . . . . . 233
    - Repair . . . . . 234
  - Environment
    - Mechanical load . . . . . 253
    - Storage temperature . . . . . 252
    - Vibration- and shock-resistance . . . . . 253
  - Error messages
    - see Diagnostic messages
  - Event list . . . . . 227
  - Event logbook . . . . . 227
  - Ex approval . . . . . 263
  - Extended order code
    - Sensor . . . . . 20
    - Transmitter . . . . . 18
  - Exterior cleaning . . . . . 233
- F**
- FDA . . . . . 263, 264
  - Field of application
    - Residual risks . . . . . 11
- FieldCare** . . . . . 85
  - Device description file . . . . . 88
  - Establishing a connection . . . . . 85
  - Function . . . . . 85
  - User interface . . . . . 86
- Filtering the event logbook . . . . . 228
  - Firmware
    - Release date . . . . . 88
    - Version . . . . . 88
  - Firmware history . . . . . 232
  - Flow direction . . . . . 24, 30
  - Flow limit . . . . . 255
  - Food Contact Materials Regulation . . . . . 263
  - Function check . . . . . 102
  - Functions
    - see Parameters
- G**
- Galvanic isolation . . . . . 247
- H**
- Hardware write protection . . . . . 147
  - Help text
    - Calling up . . . . . 73
    - Closing . . . . . 73
    - Explanation . . . . . 73
  - HistoROM . . . . . 140
- I**
- Identifying the measuring device . . . . . 17
  - Incoming acceptance . . . . . 17
  - Influence
    - Ambient temperature . . . . . 250
    - Medium pressure . . . . . 251
    - Medium temperature . . . . . 250
  - Information on the document . . . . . 6
  - Inlet runs . . . . . 25
  - Input . . . . . 240
  - Inspection
    - Received goods . . . . . 17
  - Inspection check
    - Connection . . . . . 60
  - Installation . . . . . 23
  - Installation conditions
    - Down pipe . . . . . 24
    - Inlet and outlet runs . . . . . 25
    - Installation dimensions . . . . . 25
    - Mounting location . . . . . 23
    - Orientation . . . . . 24
    - Sensor heating . . . . . 27
    - System pressure . . . . . 26
    - Thermal insulation . . . . . 26
    - Vibrations . . . . . 27
  - Installation dimensions . . . . . 25
  - Interior cleaning . . . . . 233
- L**
- Languages, operation options . . . . . 259
  - Line recorder . . . . . 157

- Local display . . . . . 259
  - Navigation view . . . . . 66
  - see Diagnostic message
  - see In alarm condition
  - see Operational display
- Low flow cut off . . . . . 247
- M**
- Main electronics module . . . . . 15
- Maintenance tasks . . . . . 233
- Managing the device configuration . . . . . 140
- Manufacturer ID . . . . . 88
- Manufacturing date . . . . . 18, 20
- Materials . . . . . 256
- Maximum measured error . . . . . 248
- Measured values
  - see Process variables
- Measuring and test equipment . . . . . 233
- Measuring device
  - Configuration . . . . . 103
  - Conversion . . . . . 234
  - Disposal . . . . . 235
  - Mounting the sensor . . . . . 30
  - Preparing for electrical connection . . . . . 41
  - Preparing for mounting . . . . . 29
  - Removing . . . . . 235
  - Repairs . . . . . 234
  - Structure . . . . . 15
  - Switch-on . . . . . 102
- Measuring principle . . . . . 239
- Measuring range
  - For liquids . . . . . 240
- Measuring range, recommended . . . . . 255
- Measuring system . . . . . 239
- Mechanical load . . . . . 253
- Medium pressure
  - Influence . . . . . 251
- Medium temperature
  - Influence . . . . . 250
- Menu
  - Diagnostics . . . . . 226
  - Setup . . . . . 103, 104
- Menus
  - For measuring device configuration . . . . . 103
  - For specific settings . . . . . 131
- Module
  - Analog input . . . . . 93
  - Analog output . . . . . 96
  - Discrete Input . . . . . 96
  - Discrete Output . . . . . 97
  - EMPTY\_MODULE . . . . . 98
  - Totalizer
    - SETTOT\_MODETOT\_TOTAL . . . . . 95
    - SETTOT\_TOTAL . . . . . 95
    - TOTAL . . . . . 94
- Mounting dimensions
  - see Installation dimensions
- Mounting location . . . . . 23
- Mounting preparations . . . . . 29
- Mounting tools . . . . . 29
- N**
- Nameplate
  - Sensor . . . . . 20
  - Transmitter . . . . . 18
- Navigation path (navigation view) . . . . . 66
- Navigation view
  - In the submenu . . . . . 66
  - In the wizard . . . . . 66
- Numeric editor . . . . . 68
- O**
- Onsite display
  - Numeric editor . . . . . 68
  - Text editor . . . . . 68
- Operable flow range . . . . . 240
- Operating elements . . . . . 70, 168
- Operating keys
  - see Operating elements
- Operating menu
  - Menus, submenus . . . . . 62
  - Structure . . . . . 62
  - Submenus and user roles . . . . . 63
- Operating philosophy . . . . . 63
- Operation . . . . . 150
- Operation options . . . . . 61
- Operational display . . . . . 64
- Operational safety . . . . . 11
- Order code . . . . . 18, 20
- Orientation (vertical, horizontal) . . . . . 24
- Outlet runs . . . . . 25
- Output . . . . . 242
- Output signal . . . . . 242
- P**
- Packaging disposal . . . . . 23
- Parameter
  - Changing . . . . . 73
  - Entering values or text . . . . . 73
- Parameter settings
  - Administration (Submenu) . . . . . 143
  - Analog inputs (Submenu) . . . . . 110
  - Calculated values (Submenu) . . . . . 132
  - Communication (Submenu) . . . . . 108
  - Configuration backup (Submenu) . . . . . 140
  - Current input . . . . . 112
  - Current input (Wizard) . . . . . 112
  - Current input 1 to n (Submenu) . . . . . 153
  - Current output . . . . . 114
  - Current output (Wizard) . . . . . 114
  - Data logging (Submenu) . . . . . 157
  - Define access code (Wizard) . . . . . 142
  - Device information (Submenu) . . . . . 230
  - Diagnostics (Menu) . . . . . 226
  - Display (Submenu) . . . . . 136
  - Display (Wizard) . . . . . 126
  - I/O configuration . . . . . 111
  - I/O configuration (Submenu) . . . . . 111

- Low flow cut off (Wizard) . . . . . 129
- Measured variables (Submenu) . . . . . 151
- Partially filled pipe detection (Wizard) . . . . . 130
- Pulse/frequency/switch output . . . . . 117
- Pulse/frequency/switch output (Wizard) . . . . . 117, 119, 122
- Pulse/frequency/switch output 1 to n (Submenu) . . . . . 155
- Relay output . . . . . 124
- Relay output 1 to n (Submenu) . . . . . 156
- Relay output 1 to n (Wizard) . . . . . 124
- Reset access code (Submenu) . . . . . 142
- Select medium (Wizard) . . . . . 108
- Sensor adjustment (Submenu) . . . . . 133
- Setup (Menu) . . . . . 104
- Simulation (Submenu) . . . . . 143
- Status input . . . . . 113
- Status input (Submenu) . . . . . 113
- Status input 1 to n (Submenu) . . . . . 154
- System units (Submenu) . . . . . 105
- Totalizer 1 to n (Submenu) . . . . . 134, 152
- Totalizer handling (Submenu) . . . . . 156
- Value current output 1 to n (Submenu) . . . . . 155
- Web server (Submenu) . . . . . 81
- WLAN Settings (Submenu) . . . . . 139
- Zero point adjustment (Submenu) . . . . . 133
- Performance characteristics . . . . . 248
- Pharmaceutical compatibility . . . . . 264
- Post-connection check (checklist) . . . . . 60
- Post-installation check . . . . . 102
- Post-installation check (checklist) . . . . . 34
- Potential equalization . . . . . 52
- Power consumption . . . . . 247
- Power supply failure . . . . . 248
- Pressure Equipment Directive . . . . . 264
- Pressure loss . . . . . 255
- Pressure-temperature ratings . . . . . 254
- Process connections . . . . . 259
- Process variables
  - Calculated . . . . . 240
  - Measured . . . . . 240
- Product safety . . . . . 11
- Proline 500 – digital transmitter
  - Connecting the signal cable/supply voltage cable . . . . . 48
- Proline 500 connecting cable terminal assignment
  - Sensor connection housing . . . . . 50
- Protecting parameter settings . . . . . 146
- R**
  - Radio approval . . . . . 264
  - RCM-tick symbol . . . . . 263
  - Read access . . . . . 74
  - Reading measured values . . . . . 150
  - Recalibration . . . . . 233
  - Reference operating conditions . . . . . 248
  - Registered trademarks . . . . . 8
  - Remedial measures
    - Calling up . . . . . 169
    - Closing . . . . . 169
  - Remote operation . . . . . 260
  - Repair . . . . . 234
  - Repair of a device . . . . . 234
  - Repairs
    - Notes . . . . . 234
  - Repeatability . . . . . 250
  - Replacement
    - Device components . . . . . 234
  - Requirements for personnel . . . . . 10
  - Response time . . . . . 250
  - Return . . . . . 234
  - S**
    - Safety . . . . . 10
    - Sanitary compatibility . . . . . 263
    - Sensor
      - Mounting . . . . . 30
    - Sensor heating . . . . . 27
    - Sensor housing . . . . . 254
    - Serial number . . . . . 18, 20
    - Setting the operating language . . . . . 102
    - Settings
      - Adapting the measuring device to the process conditions . . . . . 156
      - Administration . . . . . 141
      - Advanced display configurations . . . . . 136
      - Analog input . . . . . 110
      - Communication interface . . . . . 108
      - Current input . . . . . 112
      - Current output . . . . . 114
      - Device reset . . . . . 229
      - Device tag . . . . . 104
      - I/O configuration . . . . . 111
      - Local display . . . . . 126
      - Low flow . . . . . 129
      - Managing the device configuration . . . . . 140
      - Medium . . . . . 108
      - Operating language . . . . . 102
      - Partial filled pipe detection . . . . . 130
      - Pulse output . . . . . 117
      - Pulse/frequency/switch output . . . . . 117, 119
      - Relay output . . . . . 124
      - Resetting the totalizer . . . . . 156
      - Sensor adjustment . . . . . 133
      - Simulation . . . . . 143
      - Status input . . . . . 113
      - Switch output . . . . . 122
      - System units . . . . . 105
      - Totalizer . . . . . 134
      - Totalizer reset . . . . . 156
      - WLAN . . . . . 139
  - SETTOT\_MODETOT\_TOTAL module . . . . . 95
  - SETTOT\_TOTAL module . . . . . 95
  - Showing data logging . . . . . 157
  - Signal on alarm . . . . . 245
  - Software release . . . . . 88
  - Spare part . . . . . 234
  - Spare parts . . . . . 234
  - Special connection instructions . . . . . 53

- Special mounting instructions
    - Sanitary compatibility . . . . . 28
  - Standards and guidelines . . . . . 264
  - Status area
    - For operational display . . . . . 64
    - In the navigation view . . . . . 66
  - Status signals . . . . . 167, 170
  - Storage concept . . . . . 262
  - Storage conditions . . . . . 22
  - Storage temperature . . . . . 22
  - Storage temperature range . . . . . 252
  - Structure
    - Measuring device . . . . . 15
    - Operating menu . . . . . 62
  - Submenu
    - Administration . . . . . 141, 143
    - Advanced setup . . . . . 131
    - Analog inputs . . . . . 110
    - Calculated values . . . . . 132
    - Communication . . . . . 102, 108
    - Configuration backup . . . . . 140
    - Current input 1 to n . . . . . 153
    - Data logging . . . . . 157
    - Device information . . . . . 230
    - Display . . . . . 136
    - Event list . . . . . 227
    - I/O configuration . . . . . 111
    - Input values . . . . . 153
    - Measured values . . . . . 150
    - Measured variables . . . . . 151
    - Output values . . . . . 154
    - Overview . . . . . 63
    - Process variables . . . . . 132
    - Pulse/frequency/switch output 1 to n . . . . . 155
    - Relay output 1 to n . . . . . 156
    - Reset access code . . . . . 142
    - Sensor adjustment . . . . . 133
    - Simulation . . . . . 143
    - Status input . . . . . 113
    - Status input 1 to n . . . . . 154
    - System units . . . . . 105
    - Totalizer 1 to n . . . . . 134, 152
    - Totalizer handling . . . . . 156
    - Value current output 1 to n . . . . . 155
    - Web server . . . . . 81
    - WLAN Settings . . . . . 139
    - Zero point adjustment . . . . . 133
  - Supply voltage . . . . . 247
  - Surface roughness . . . . . 259
  - Switch output . . . . . 244
  - Symbols
    - Controlling data entries . . . . . 69
    - For communication . . . . . 64
    - For diagnostic behavior . . . . . 64
    - For locking . . . . . 64
    - For measured variable . . . . . 65
    - For measurement channel number . . . . . 65
    - For menus . . . . . 67
    - For parameters . . . . . 67
    - For status signal . . . . . 64
    - For submenu . . . . . 67
    - For wizard . . . . . 67
    - In the status area of the local display . . . . . 64
    - Input screen . . . . . 69
    - Operating elements . . . . . 68
  - System design
    - Measuring system . . . . . 239
    - see Measuring device design
  - System integration . . . . . 88
  - System pressure . . . . . 26
- T**
- Technical data, overview . . . . . 239
  - Temperature range
    - Ambient temperature range for display . . . . . 259
    - Medium temperature . . . . . 254
    - Storage temperature . . . . . 22
  - Terminal assignment . . . . . 40
  - Terminal assignment of connecting cable for Proline 500- digital
    - Sensor connection housing . . . . . 43
  - Terminals . . . . . 248
  - Tests and certificates . . . . . 264
  - Text editor . . . . . 68
  - Thermal insulation . . . . . 26
  - Tool tip
    - see Help text
  - Tools
    - Electrical connection . . . . . 35
    - For mounting . . . . . 29
    - Transport . . . . . 22
  - TOTAL module . . . . . 94
  - Totalizer
    - Assign process variable . . . . . 152
    - Configuration . . . . . 134
    - Operation . . . . . 156
    - Reset . . . . . 156
  - Transmitter
    - Turning the display module . . . . . 33
    - Turning the housing . . . . . 33
  - Transporting the measuring device . . . . . 22
  - Troubleshooting
    - General . . . . . 161
  - TSE/BSE Certificate of Suitability . . . . . 264
  - Turning the display module . . . . . 33
  - Turning the electronics housing
    - see Turning the transmitter housing
  - Turning the transmitter housing . . . . . 33
- U**
- Use of the measuring device
    - Borderline cases . . . . . 10
    - Incorrect use . . . . . 10
    - see Designated use
  - User interface
    - Current diagnostic event . . . . . 226
    - Previous diagnostic event . . . . . 226
  - User roles . . . . . 63

USP Class VI . . . . .	264
<b>V</b>	
Version data for the device . . . . .	88
Vibration- and shock-resistance . . . . .	253
Vibrations . . . . .	27
<b>W</b>	
W@M . . . . .	233, 234
W@M Device Viewer . . . . .	17, 234
Weight	
SI units . . . . .	256
Transport (notes) . . . . .	22
US units . . . . .	256
Wizard	
Current input . . . . .	112
Current output . . . . .	114
Define access code . . . . .	142
Display . . . . .	126
Low flow cut off . . . . .	129
Partially filled pipe detection . . . . .	130
Pulse/frequency/switch output . . . . .	117, 119, 122
Relay output 1 to n . . . . .	124
Select medium . . . . .	108
WLAN settings . . . . .	139
Workplace safety . . . . .	11
Write access . . . . .	74
Write protection	
Via access code . . . . .	146
Via write protection switch . . . . .	147
Write protection switch . . . . .	147





[www.addresses.endress.com](http://www.addresses.endress.com)

---