

# Operating Instructions

## CNGmass

### Modbus RS485

Coriolis flowmeter

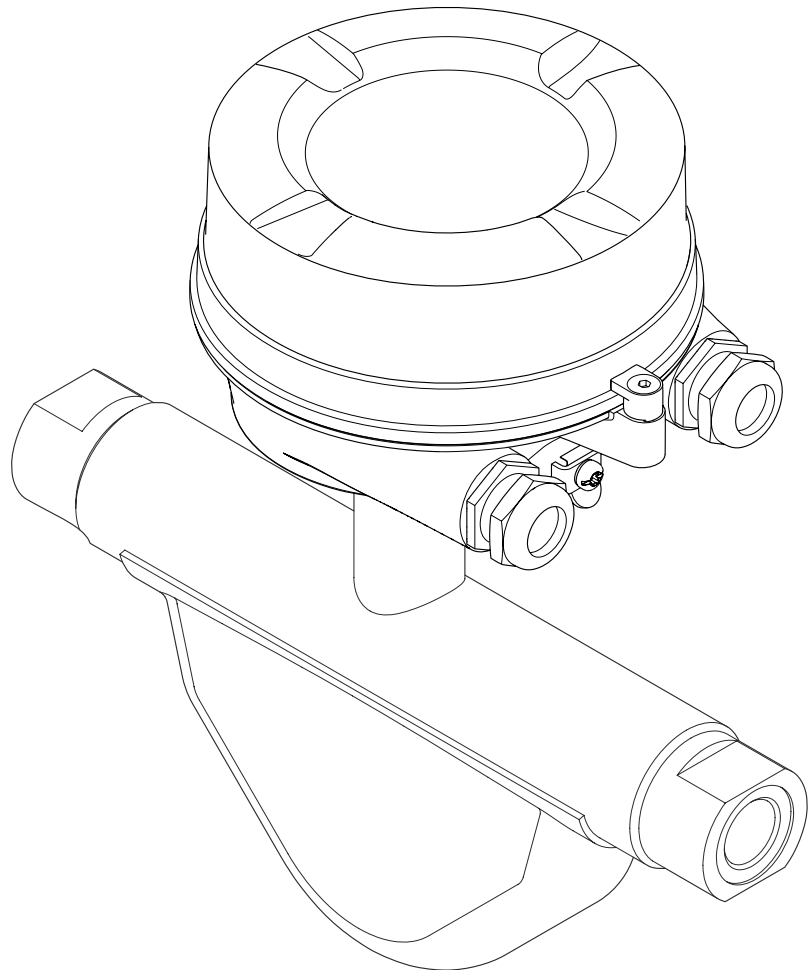

- Make sure the document is stored in a safe place such that it is always available when working on or with the device.
- To avoid danger to individuals or the facility, read the "Basic safety instructions" section carefully, as well as all other safety instructions in the document that are specific to working procedures.
- The manufacturer reserves the right to modify technical data without prior notice. Your Endress+Hauser Sales Center will supply you with current information and updates to these Instructions.

## Table of contents

<b>1</b>	<b>Document information</b> . . . . .	<b>5</b>			
1.1	Document function . . . . .	5			
1.2	Symbols used . . . . .	5			
1.2.1	Safety symbols . . . . .	5			
1.2.2	Electrical symbols . . . . .	5			
1.2.3	Tool symbols . . . . .	6			
1.2.4	Symbols for certain types of information . . . . .	6			
1.2.5	Symbols in graphics . . . . .	6			
1.3	Documentation . . . . .	7			
1.3.1	Standard documentation . . . . .	7			
1.3.2	Supplementary device-dependent documentation . . . . .	7			
1.4	Registered trademarks . . . . .	7			
<b>2</b>	<b>Basic safety instructions</b> . . . . .	<b>8</b>			
2.1	Requirements for the personnel . . . . .	8			
2.2	Designated use . . . . .	8			
2.3	Workplace safety . . . . .	9			
2.4	Operational safety . . . . .	9			
2.5	Product safety . . . . .	9			
2.6	IT security . . . . .	9			
<b>3</b>	<b>Product description</b> . . . . .	<b>11</b>			
3.1	Product design . . . . .	11			
3.1.1	Device version with Modbus RS485 communication type . . . . .	11			
<b>4</b>	<b>Incoming acceptance and product identification</b> . . . . .	<b>12</b>			
4.1	Incoming acceptance . . . . .	12			
4.2	Product identification . . . . .	12			
4.2.1	Transmitter nameplate . . . . .	13			
4.2.2	Sensor nameplate . . . . .	13			
4.2.3	Promass 100 safety barrier - nameplate . . . . .	14			
4.2.4	Symbols on measuring device . . . . .	14			
<b>5</b>	<b>Storage and transport</b> . . . . .	<b>15</b>			
5.1	Storage conditions . . . . .	15			
5.2	Transporting the product . . . . .	15			
5.3	Packaging disposal . . . . .	16			
<b>6</b>	<b>Installation</b> . . . . .	<b>17</b>			
6.1	Installation conditions . . . . .	17			
6.1.1	Mounting position . . . . .	17			
6.1.2	Requirements from environment and process . . . . .	17			
6.1.3	Special mounting instructions . . . . .	17			
6.2	Mounting the measuring device . . . . .	18			
6.2.1	Required tools . . . . .	18			
6.2.2	Preparing the measuring device . . . . .	18			
6.2.3	Mounting the measuring device . . . . .	19			
6.3	Post-installation check . . . . .	19			
<b>7</b>	<b>Electrical connection</b> . . . . .	<b>20</b>			
7.1	Connection conditions . . . . .	20			
7.1.1	Required tools . . . . .	20			
7.1.2	Requirements for connecting cable . . . . .	20			
7.1.3	Terminal assignment . . . . .	22			
7.1.4	Shielding and grounding . . . . .	23			
7.1.5	Preparing the measuring device . . . . .	23			
7.2	Connecting the measuring device . . . . .	24			
7.2.1	Connecting the transmitter . . . . .	24			
7.2.2	Connecting the Safety Barrier Promass 100 . . . . .	25			
7.3	Hardware settings . . . . .	26			
7.3.1	Enabling the terminating resistor . . . . .	26			
7.4	Ensuring the degree of protection . . . . .	27			
7.5	Post-connection check . . . . .	27			
<b>8</b>	<b>Operation options</b> . . . . .	<b>28</b>			
8.1	Overview of operation options . . . . .	28			
8.2	Structure and function of the operating menu . . . . .	29			
8.2.1	Structure of the operating menu . . . . .	29			
8.2.2	Operating philosophy . . . . .	30			
8.3	Access to the operating menu via the operating tool . . . . .	31			
8.3.1	Connecting the operating tool . . . . .	31			
8.3.2	FieldCare . . . . .	31			
<b>9</b>	<b>System integration</b> . . . . .	<b>33</b>			
9.1	Overview of device description files . . . . .	33			
9.1.1	Current version data for the device . . . . .	33			
9.1.2	Operating tools . . . . .	33			
9.2	Modbus RS485 information . . . . .	33			
9.2.1	Function codes . . . . .	33			
9.2.2	Register information . . . . .	34			
9.2.3	Response time . . . . .	34			
9.2.4	Modbus data map . . . . .	34			
<b>10</b>	<b>Commissioning</b> . . . . .	<b>37</b>			
10.1	Function check . . . . .	37			
10.2	Establishing a connection via FieldCare . . . . .	37			
10.3	Configuring the measuring device . . . . .	37			
10.3.1	Defining the tag name . . . . .	37			
10.3.2	Setting the system units . . . . .	37			
10.3.3	Selecting and setting the medium . . . . .	40			
10.3.4	Configuring the communication interface . . . . .	40			
10.3.5	Configuring the low flow cut off . . . . .	43			
10.3.6	Configuring the partial filled pipe detection . . . . .	44			

10.4	Advanced settings . . . . .	45	14.4	Return . . . . .	64
10.4.1	Calculated values . . . . .	45	14.5	Disposal . . . . .	64
10.4.2	Carrying out a sensor adjustment . . . . .	46	14.5.1	Removing the measuring device . . . . .	64
10.4.3	Configuring the totalizer . . . . .	46	14.5.2	Disposing of the measuring device . . . . .	65
10.5	Simulation . . . . .	47			
10.6	Protecting settings from unauthorized access . . . . .	48	<b>15</b>	<b>Accessories . . . . .</b>	<b>66</b>
10.6.1	Write protection via write protection switch . . . . .	48	15.1	Communication-specific accessories . . . . .	66
			15.2	Service-specific accessories . . . . .	66
<b>11</b>	<b>Operation . . . . .</b>	<b>50</b>	<b>16</b>	<b>Technical data . . . . .</b>	<b>67</b>
11.1	Reading device locking status . . . . .	50	16.1	Application . . . . .	67
11.2	Reading measured values . . . . .	50	16.2	Function and system design . . . . .	67
11.2.1	Process variables . . . . .	50	16.3	Input . . . . .	67
11.2.2	Totalizer . . . . .	51	16.4	Output . . . . .	68
11.3	Adapting the measuring device to the process conditions . . . . .	51	16.5	Power supply . . . . .	69
11.4	Performing a totalizer reset . . . . .	52	16.6	Performance characteristics . . . . .	70
			16.7	Installation . . . . .	71
			16.8	Environment . . . . .	71
			16.9	Process . . . . .	71
<b>12</b>	<b>Diagnostics and troubleshooting . . . . .</b>	<b>53</b>	16.10	Mechanical construction . . . . .	73
12.1	General troubleshooting . . . . .	53	16.11	Operability . . . . .	74
12.2	Diagnostic information via light emitting diodes . . . . .	53	16.12	Certificates and approvals . . . . .	75
12.2.1	Transmitter . . . . .	53	16.13	Application packages . . . . .	75
12.2.2	Safety Barrier Promass 100 . . . . .	54	16.14	Accessories . . . . .	75
12.3	Diagnostic information in FieldCare . . . . .	54	16.15	Documentation . . . . .	75
12.3.1	Diagnostic options . . . . .	54			
12.3.2	Calling up remedy information . . . . .	55	<b>17</b>	<b>Appendix . . . . .</b>	<b>77</b>
12.4	Diagnostic information via communication interface . . . . .	55	17.1	Overview of the operating menu . . . . .	77
12.4.1	Reading out diagnostic information . . . . .	55			
12.4.2	Configuring error response mode . . . . .	56	<b>Index . . . . .</b>	<b>88</b>	
12.5	Adapting the diagnostic information . . . . .	56			
12.5.1	Adapting the diagnostic behavior . . . . .	56			
12.6	Overview of diagnostic information . . . . .	57			
12.7	Pending diagnostic events . . . . .	58			
12.8	Diagnostic list . . . . .	59			
12.9	Event logbook . . . . .	59			
12.9.1	Event history . . . . .	59			
12.9.2	Filtering the event logbook . . . . .	60			
12.9.3	Overview of information events . . . . .	60			
12.10	Resetting the measuring device . . . . .	61			
12.11	Device information . . . . .	61			
12.12	Firmware history . . . . .	62			
<b>13</b>	<b>Maintenance . . . . .</b>	<b>63</b>			
13.1	Maintenance tasks . . . . .	63			
13.1.1	Exterior cleaning . . . . .	63			
13.1.2	Interior cleaning . . . . .	63			
13.2	Measuring and test equipment . . . . .	63			
13.3	Endress+Hauser services . . . . .	63			
<b>14</b>	<b>Repair . . . . .</b>	<b>64</b>			
14.1	General notes . . . . .	64			
14.2	Spare parts . . . . .	64			
14.3	Endress+Hauser services . . . . .	64			

# 1 Document information

## 1.1 Document function

These Operating Instructions contain all the information that is required in various phases of the life cycle of the device: from product identification, incoming acceptance and storage, to mounting, connection, operation and commissioning through to troubleshooting, maintenance and disposal.

## 1.2 Symbols used



### 1.2.1 Safety symbols

Symbol	Meaning
 A0011189-EN	<b>DANGER!</b> This symbol alerts you to a dangerous situation. Failure to avoid this situation will result in serious or fatal injury.
 A0011190-EN	<b>WARNING!</b> This symbol alerts you to a dangerous situation. Failure to avoid this situation can result in serious or fatal injury.
 A0011191-EN	<b>CAUTION!</b> This symbol alerts you to a dangerous situation. Failure to avoid this situation can result in minor or medium injury.
 A0011192-EN	<b>NOTICE!</b> This symbol contains information on procedures and other facts which do not result in personal injury.











### 1.2.2 Electrical symbols

Symbol	Meaning
 A0011197	<b>Direct current</b> A terminal to which DC voltage is applied or through which direct current flows.
 A0011198	<b>Alternating current</b> A terminal to which alternating voltage is applied or through which alternating current flows.
 A0017381	<b>Direct current and alternating current</b> <ul style="list-style-type: none"> <li>▪ A terminal to which alternating voltage or DC voltage is applied.</li> <li>▪ A terminal through which alternating current or direct current flows.</li> </ul>
 A0011200	<b>Ground connection</b> A grounded terminal which, as far as the operator is concerned, is grounded via a grounding system.
 A0011199	<b>Protective ground connection</b> A terminal which must be connected to ground prior to establishing any other connections.
 A0011201	<b>Equipotential connection</b> A connection that has to be connected to the plant grounding system: This may be a potential equalization line or a star grounding system depending on national or company codes of practice.





### 1.2.3 Tool symbols

Symbol	Meaning
 A0011221	Allen key
 A0011222	Open-ended wrench



### 1.2.4 Symbols for certain types of information

Symbol	Meaning
 A0011182	<b>Allowed</b> Indicates procedures, processes or actions that are allowed.
 A0011183	<b>Preferred</b> Indicates procedures, processes or actions that are preferred.
 A0011184	<b>Forbidden</b> Indicates procedures, processes or actions that are forbidden.
 A0011193	<b>Tip</b> Indicates additional information.
 A0011194	<b>Reference to documentation</b> Refers to the corresponding device documentation.
 A0011195	<b>Reference to page</b> Refers to the corresponding page number.
 A0011196	<b>Reference to graphic</b> Refers to the corresponding graphic number and page number.
	<b>Series of steps</b>
	<b>Result of a sequence of actions</b>
 A0013562	<b>Help in the event of a problem</b>
 A0015502	<b>Visual inspection</b>

### 1.2.5 Symbols in graphics

Symbol	Meaning
<b>1, 2, 3,...</b>	Item numbers
	Series of steps
<b>A, B, C, ...</b>	Views
<b>A-A, B-B, C-C, ...</b>	Sections
 A0013441	Flow direction
 A0011187	<b>Hazardous area</b> Indicates a hazardous area.
 A0011188	<b>Safe area (non-hazardous area)</b> Indicates a non-hazardous area.

## 1.3 Documentation

-  For an overview of the scope of the associated Technical Documentation, refer to the following:
- The CD-ROM provided for the device (depending on the device version, the CD-ROM might not be part of the delivery!)
  - The *W@M Device Viewer* : Enter the serial number from the nameplate ([www.endress.com/deviceviewer](http://www.endress.com/deviceviewer))
  - The *Endress+Hauser Operations App*: Enter the serial number from the nameplate or scan the 2-D matrix code (QR code) on the nameplate.
-  For a detailed list of the individual documents along with the documentation code (→  75)

### 1.3.1 Standard documentation

Document type	Purpose and content of the document
Technical Information	<b>Planning aid for your device</b> The document contains all the technical data on the device and provides an overview of the accessories and other products that can be ordered for the device.
Brief Operating Instructions	<b>Guide that takes you quickly to the 1st measured value</b> The Brief Operating Instructions contain all the essential information from incoming acceptance to initial commissioning.
Modbus RS485 register information	<b>Reference for Modbus RS485 register information</b> The document provides Modbus-specific information for each individual parameter in the operating menu.

### 1.3.2 Supplementary device-dependent documentation

Additional documents are supplied depending on the device version ordered: Always comply strictly with the instructions in the supplementary documentation. The supplementary documentation is an integral part of the device documentation.

## 1.4 Registered trademarks

**Modbus®**

Registered trademark of SCHNEIDER AUTOMATION, INC.

## 2 Basic safety instructions

### 2.1 Requirements for the personnel

The personnel for installation, commissioning, diagnostics and maintenance must fulfill the following requirements:

- ▶ Trained, qualified specialists must have a relevant qualification for this specific function and task
- ▶ Are authorized by the plant owner/operator
- ▶ Are familiar with federal/national regulations
- ▶ Before beginning work, the specialist staff must have read and understood the instructions in the Operating Instructions and supplementary documentation as well as in the certificates (depending on the application)
- ▶ Following instructions and basic conditions

The operating personnel must fulfill the following requirements:

- ▶ Being instructed and authorized according to the requirements of the task by the facility's owner-operator
- ▶ Following the instructions in these Operating Instructions

### 2.2 Designated use

#### Application and media

The measuring device described in these Instructions is intended only for flow measurement of liquids and gases.

Depending on the version ordered, the measuring device can also measure potentially explosive, flammable, poisonous and oxidizing media.

Measuring devices for use in hazardous areas, in hygienic applications or in applications where there is an increased risk due to process pressure, are labeled accordingly on the nameplate.

To ensure that the measuring device remains in proper condition for the operation time:

- ▶ Only use the measuring device in full compliance with the data on the nameplate and the general conditions listed in the Operating Instructions and supplementary documentation.
- ▶ Based on the nameplate, check whether the ordered device is permitted for the intended use in the hazardous area (e.g. explosion protection, pressure vessel safety).
- ▶ Use the measuring device only for media against which the process-wetted materials are adequately resistant.
- ▶ If the measuring device is not operated at atmospheric temperature, compliance with the relevant basic conditions specified in the associated device documentation is absolutely essential: "Documentation" section (→  7).

#### Incorrect use

Non-designated use can compromise safety. The manufacturer is not liable for damage caused by improper or non-designated use.

#### WARNING

#### Danger of breakage of the measuring tube due to corrosive or abrasive fluids.

Housing breakage due to mechanical overload possible!

- ▶ Verify the compatibility of the process fluid with the measuring tube material.
- ▶ Ensure the resistance of all fluid-wetted materials in the process.
- ▶ Observe the specified pressure and temperature range.

Verification for borderline cases:

- ▶ For special fluids and fluids for cleaning, Endress+Hauser is glad to provide assistance in verifying the corrosion resistance of fluid-wetted materials, but does not accept any



warranty or liability as minute changes in the temperature, concentration or level of contamination in the process can alter the corrosion resistance properties.

#### **Residual risks**

The external surface temperature of the housing can increase by max. 20 K due to the power consumption of the electronic components. Hot process fluids passing through the measuring device will further increase the surface temperature of the housing. The surface of the sensor, in particular, can reach temperatures which are close to the fluid temperature.

Possible burn hazard due to fluid temperatures!

- ▶ For elevated fluid temperature, ensure protection against contact to prevent burns.

## **2.3 Workplace safety**

For work on and with the device:

- ▶ Wear the required personal protective equipment according to federal/national regulations.

For welding work on the piping:

- ▶ Do not ground the welding unit via the measuring device.

If working on and with the device with wet hands:

- ▶ It is recommended to wear gloves on account of the higher risk of electric shock.

## **2.4 Operational safety**

Risk of injury.

- ▶ Operate the device in proper technical condition and fail-safe condition only.
- ▶ The operator is responsible for interference-free operation of the device.

#### **Conversions to the device**

Unauthorized modifications to the device are not permitted and can lead to unforeseeable dangers.

- ▶ If, despite this, modifications are required, consult with Endress+Hauser.

#### **Repair**

To ensure continued operational safety and reliability,

- ▶ Carry out repairs on the device only if they are expressly permitted.
- ▶ Observe federal/national regulations pertaining to repair of an electrical device.
- ▶ Use original spare parts and accessories from Endress+Hauser only.

## **2.5 Product safety**

This measuring device is designed in accordance with good engineering practice to meet state-of-the-art safety requirements, has been tested, and left the factory in a condition in which it is safe to operate.

It meets general safety standards and legal requirements. It also complies with the EC directives listed in the device-specific EC Declaration of Conformity. Endress+Hauser confirms this by affixing the CE mark to the device.

## **2.6 IT security**

We only provide a warranty if the device is installed and used as described in the Operating Instructions. The device is equipped with security mechanisms to protect it against any inadvertent changes to the device settings.

IT security measures in line with operators' security standards and designed to provide additional protection for the device and device data transfer must be implemented by the operators themselves.

Endress+Hauser can be contacted to provide support in performing this task.

## 3 Product description

### 3.1 Product design

#### 3.1.1 Device version with Modbus RS485 communication type

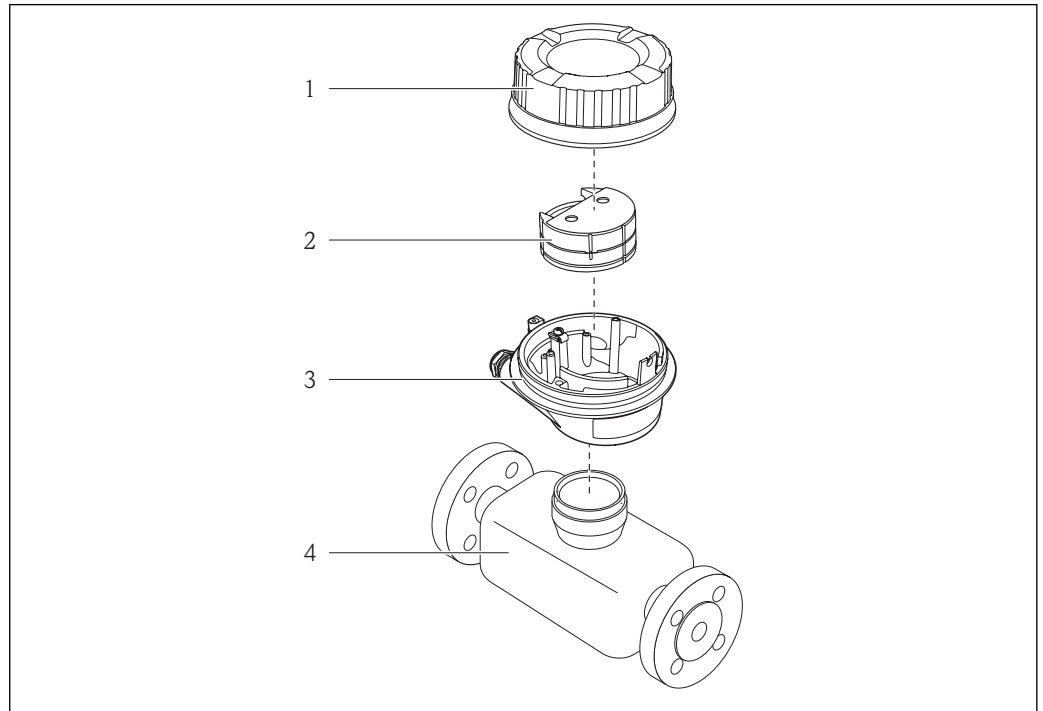

A0017609













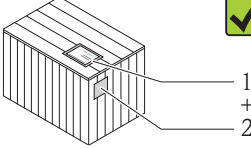

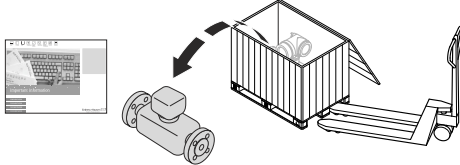

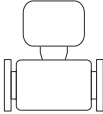
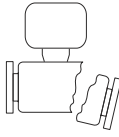
#### 1 Important components of a measuring device

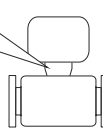

- 1 Transmitter housing cover
- 2 Main electronics module
- 3 Transmitter housing
- 4 Sensor

 In the case of the device version with Modbus RS485 intrinsically safe, the Safety Barrier Promass 100 forms part of the scope of supply.

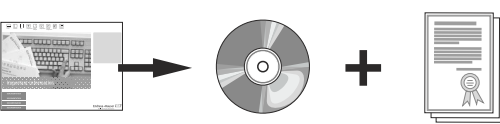
## 4 Incoming acceptance and product identification

### 4.1 Incoming acceptance

 A0015502					Are the order codes on the delivery note (1) and the product sticker (2) identical?	
A0013843						
						A0013695
 A0015502					Are the goods undamaged?	
A0013698						
 A0015502					Do the nameplate data match the ordering information on the delivery note?	
A0013699						
 A0015502				Is the CD-ROM with the Technical Documentation (depends on device version) and documents present?		
A0013697						



-  If one of the conditions is not satisfied, contact your Endress+Hauser Sales Center.
- Depending on the device version, the CD-ROM might not be part of the delivery! In such cases, the technical documentation is available via the Internet or via the *Endress+Hauser Operations App*, see the "Product identification" section (→  13).

### 4.2 Product identification

The following options are available for identification of the measuring device:

- Nameplate specifications
- Order code with breakdown of the device features on the delivery note
- Enter serial numbers from nameplates in *W@M Device Viewer* ([www.endress.com/deviceviewer](http://www.endress.com/deviceviewer)): All information about the measuring device is displayed.
- Enter the serial number from the nameplates into the *Endress+Hauser Operations App* or scan the 2-D matrix code (QR code) on the nameplate with the *Endress+Hauser Operations App*: all the information for the measuring device is displayed.

For an overview of the scope of the associated Technical Documentation, refer to the following:

- The chapters "Additional standard documentation on the device" (→  7) and "Supplementary device-dependent documentation" (→  7)
- The *W@M Device Viewer*: Enter the serial number from the nameplate ([www.endress.com/deviceviewer](http://www.endress.com/deviceviewer))
- The *Endress+Hauser Operations App*: Enter the serial number from the nameplate or scan the 2-D matrix code (QR code) on the nameplate.

### 4.2.1 Transmitter nameplate

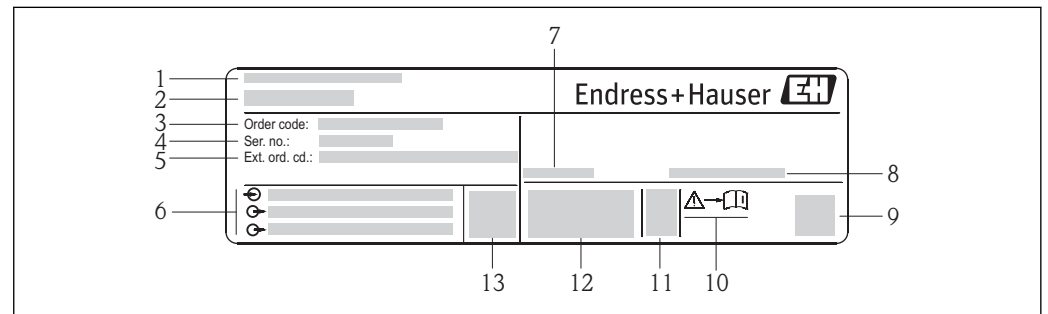

A0017520

 2 Example of a transmitter nameplate

- 1 Manufacturing location
- 2 Name of the transmitter
- 3 Order code
- 4 Serial number
- 5 Extended order code
- 6 Electrical connection data, e.g. available inputs and outputs, supply voltage
- 7 Permitted ambient temperature range ( $T_a$ )
- 8 Degree of protection
- 9 2-D matrix code
- 10 Document number of safety-related supplementary documentation (→  76)
- 11 Manufacturing date: year-month
- 12 CE mark, C-Tick
- 13 Firmware version (FW)

### 4.2.2 Sensor nameplate



#### Order code

The measuring device is reordered using the order code.

#### Extended order code

- The device type (product root) and basic specifications (mandatory features) are always listed.
- Of the optional specifications (optional features), only the safety and approval-related specifications are listed (e.g. LA). If other optional specifications are also ordered, these are indicated collectively using the # placeholder symbol (e.g. #LA#).
- If the ordered optional specifications do not include any safety and approval-related specifications, they are indicated by the + placeholder symbol (e.g. XXXXXX-ABCDE+).

### 4.2.3 Promass 100 safety barrier - nameplate

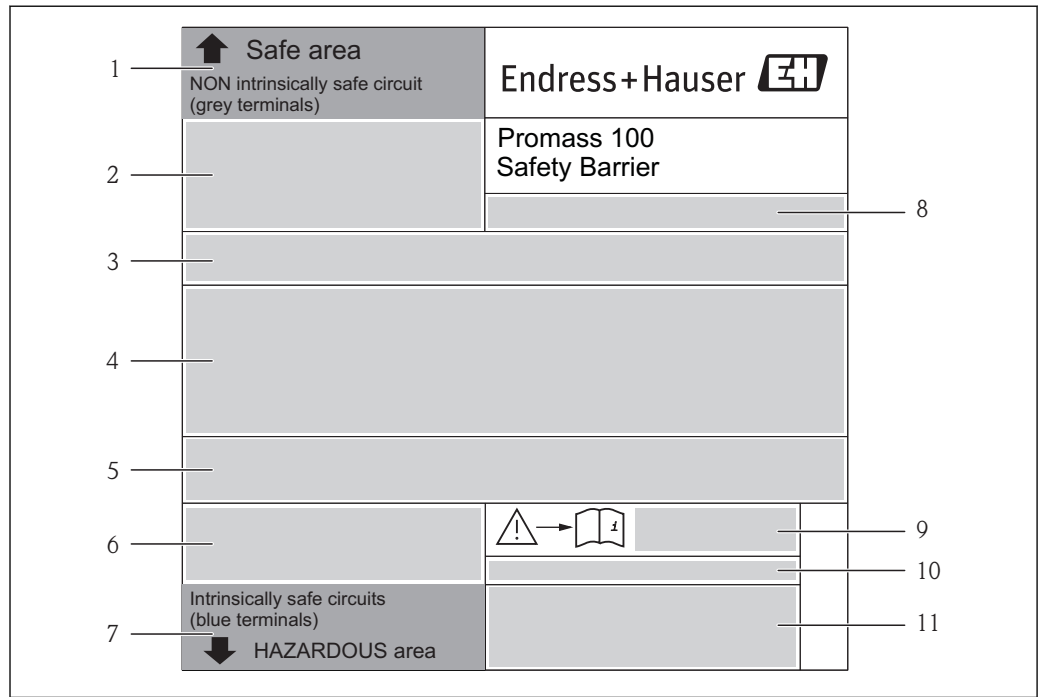

A0017854

3 Example of a Safety Barrier Promass 100 nameplate

- 1 Non-hazardous area or zone 2/div. 2
- 2 Serial number, material number and 2-D matrix code of the Safety Barrier Promass 100
- 3 Electrical connection data, e.g. available inputs and outputs, supply voltage
- 4 Approval information for explosion protection
- 5 Safety warning
- 6 Communication-specific information
- 7 Intrinsically safe area
- 8 Manufacturing location
- 9 Document number of safety-related supplementary documentation (→ 76)
- 10 Permitted ambient temperature ( $T_a$ )
- 11 CE mark, C-Tick

### 4.2.4 Symbols on measuring device

Symbol	Meaning
	<b>WARNING!</b> This symbol alerts you to a dangerous situation. Failure to avoid this situation can result in serious or fatal injury.
 <small>A0011194</small>	<b>Reference to documentation</b> Refers to the corresponding device documentation.
 <small>A0011199</small>	<b>Protective ground connection</b> A terminal which must be connected to ground prior to establishing any other connections.

## 5 Storage and transport

### 5.1 Storage conditions

Observe the following notes for storage:

- Store in the original packaging to ensure protection from shock.
- Do not remove protective covers or protective caps installed on process connections. They prevent mechanical damage to the sealing surfaces and fouling in the measuring tube.
- Protect from direct sunlight to avoid unacceptably high surface temperatures.
- Storage temperature:  $-40$  to  $+80$  °C ( $-40$  to  $+176$  °F), preferable for  $+20$  °C ( $+68$  °F)
- Store in a dry and dust-free place.
- Do not store outdoors.

### 5.2 Transporting the product

#### **⚠ WARNING**

**Center of gravity of the measuring device is higher than the suspension points of the webbing slings.**

Risk of injury if the measuring device slips.

- ▶ Secure the measuring device from rotating or slipping.
- ▶ Observe the weight specified on the packaging (stick-on label).
- ▶ Observe the transport instructions on the stick-on label on the electronics compartment cover.

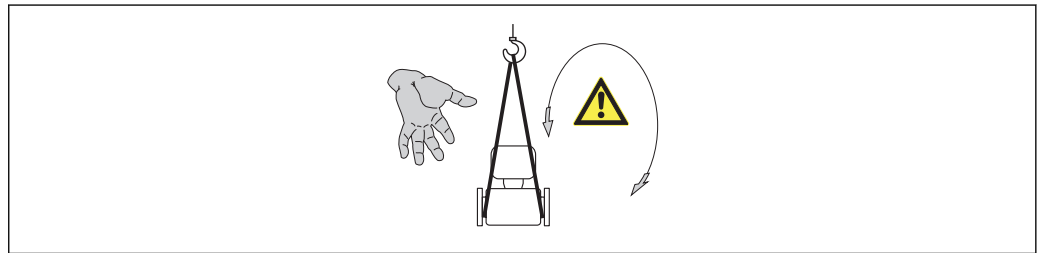

A0015606

Observe the following notes during transport:

- Transport the measuring device to the measuring point in the original packaging.
- Lifting gear
  - Webbing slings: Do not use chains, as they could damage the housing.
  - For wood crates, the floor structure enables these to be loaded lengthwise or broadside using a forklift.
- For measuring device > DN 40 (1½ in): lift the measuring device using the webbing slings at the process connections; do not lift at the transmitter housing.
- Do not remove protective covers or protective caps installed on process connections. They prevent mechanical damage to the sealing surfaces and fouling in the measuring tube.

### 5.3 Packaging disposal

All packaging materials are environmentally friendly and 100% recyclable:

- Measuring device secondary packaging: polymer stretch film that conforms to EC Directive 2002/95/EC (RoHS).
- Packaging:
  - Wood crate, treated in accordance with ISPM 15 standard, which is confirmed by the affixed IPPC logo.
  - or
  - Carton in accordance with European Packaging Directive 94/62EC; recyclability is confirmed by the affixed RESY symbol.
- Seaworthy packaging (optional): Wood crate, treated in accordance with ISPM 15 standard, which is confirmed by the affixed IPPC logo.
- Carrying and mounting hardware:
  - Disposable plastic pallet
  - Plastic straps
  - Plastic adhesive strips
- Dunnage: Paper cushion



## 6 Installation

### 6.1 Installation conditions

No special measures such as supports are necessary. External forces are absorbed by the construction of the device.

#### 6.1.1 Mounting position

##### Inlet and outlet runs

No special precautions need to be taken for fittings which create turbulence, such as valves, elbows or T-pieces, as long as no cavitation occurs .

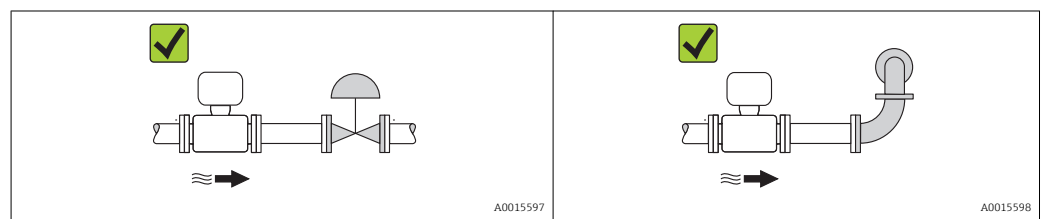

##### Installation dimensions

 For the dimensions and installation lengths of the device, see the "Technical Information" document, "Mechanical construction" section

#### 6.1.2 Requirements from environment and process

##### Ambient temperature range

Measuring device	-40 to +60 °C (-40 to +140 °F)
Safety Barrier Promass 100	-40 to +60 °C (-40 to +140 °F)

- ▶ If operating outdoors:  
Avoid direct sunlight, particularly in warm climatic regions.

##### Vibrations

The high oscillation frequency of the measuring tubes ensures that the correct operation of the measuring system is not influenced by plant vibrations.

#### 6.1.3 Special mounting instructions

##### Rupture disk

Make sure that the function and operation of the rupture disk is not impeded through the installation of the device. The position of the rupture disk is indicated on a sticker applied over it. If the rupture disk is triggered, the sticker is destroyed. The disk can therefore be visually monitored. For additional information that is relevant to the process (→  72).

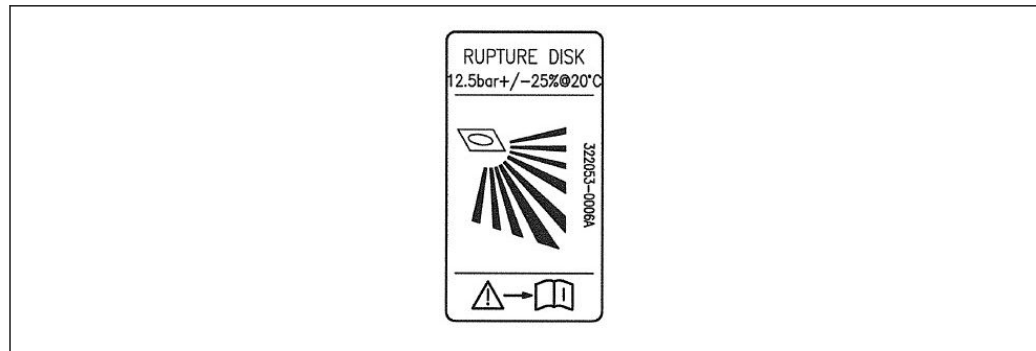

A0022770

 4 Rupture disk label**⚠ WARNING****Limited functional reliability of the rupture disk.**

Danger to persons from escaping fluids!

- ▶ Do not remove the rupture disk.
- ▶ When using a rupture disk, do not use a heating jacket.
- ▶ Make sure that the function and operation of the rupture disk is not impeded through the installation of the device.
- ▶ Take precautions to prevent damage and danger to persons if the rupture disk is actuated.
- ▶ Observe information on the rupture disk sticker.

**Zero point adjustment**

All measuring devices are calibrated in accordance with state-of-the-art technology. Calibration takes place under reference conditions (→  70). Therefore, a zero point adjustment in the field is generally not required.

Experience shows that zero point adjustment is advisable only in special cases:

- To achieve maximum measuring accuracy even with low flow rates
- Under extreme process or operating conditions (e.g. very high process temperatures or very high-viscosity fluids).

## 6.2 Mounting the measuring device

### 6.2.1 Required tools

**For sensor**

For flanges and other process connections: Corresponding mounting tools

### 6.2.2 Preparing the measuring device

1. Remove all remaining transport packaging.
2. Remove any protective covers or protective caps present from the sensor.
3. Remove stick-on label on the electronics compartment cover.

### 6.2.3 Mounting the measuring device

**⚠ WARNING**

**Danger due to improper process sealing!**

- ▶ Ensure that the inside diameters of the gaskets are greater than or equal to that of the process connections and piping.
  - ▶ Ensure that the gaskets are clean and undamaged.
  - ▶ Install the gaskets correctly.
1. Ensure that the direction of the arrow on the nameplate of the sensor matches the flow direction of the fluid.
  2. Install the measuring device or turn the transmitter housing so that the cable entries do not point upwards.

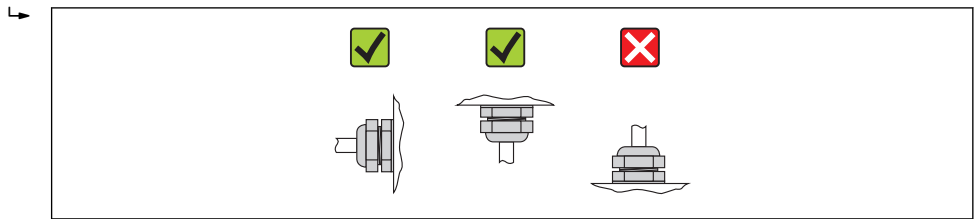

A0013964

### 6.3 Post-installation check

Is the device undamaged (visual inspection)?	<input type="checkbox"/>
Does the measuring device conform to the measuring point specifications? For example: <ul style="list-style-type: none"> <li>▪ Process temperature (→ 71)</li> <li>▪ Process pressure (refer to the chapter on "Material load curves" of the "Technical Information" document)</li> <li>▪ Ambient temperature (→ 17)</li> <li>▪ Measuring range (→ 67)</li> </ul>	<input type="checkbox"/>
Has the correct orientation for the sensor been selected ? <ul style="list-style-type: none"> <li>▪ According to sensor type</li> <li>▪ According to medium temperature</li> <li>▪ According to medium properties (outgassing, with entrained solids)</li> </ul>	<input type="checkbox"/>
Does the arrow on the sensor nameplate match the direction of flow of the fluid through the piping ?	<input type="checkbox"/>
Are the measuring point identification and labeling correct (visual inspection)?	<input type="checkbox"/>
Is the device adequately protected from precipitation and direct sunlight?	<input type="checkbox"/>
Are the securing screw and securing clamp tightened securely?	<input type="checkbox"/>

## 7 Electrical connection

**i** The measuring device does not have an internal circuit breaker. For this reason, assign the measuring device a switch or power-circuit breaker so that the power supply line can be easily disconnected from the mains.

### 7.1 Connection conditions

#### 7.1.1 Required tools

- For cable entries: Use corresponding tools
- For securing clamp (on aluminum housing): Allen screw 3 mm
- For securing screw (for stainless steel housing): open-ended wrench 8 mm
- Wire stripper
- When using stranded cables: crimping tool for ferrule

#### 7.1.2 Requirements for connecting cable

The connecting cables provided by the customer must fulfill the following requirements.

##### Electrical safety

In accordance with applicable federal/national regulations.

##### Permitted temperature range

- $-40\text{ °C}$  ( $-40\text{ °F}$ ) to  $+80\text{ °C}$  ( $+176\text{ °F}$ )
- Minimum requirement: cable temperature range  $\geq$  ambient temperature  $+20\text{ K}$

##### Power supply cable

Standard installation cable is sufficient.

##### Signal cable

###### *Modbus RS485*

The EIA/TIA-485 standard specifies two types of cable (A and B) for the bus line which can be used for every transmission rate. Cable type A is recommended.

<b>Cable type</b>	A
<b>Characteristic impedance</b>	135 to 165 $\Omega$ at a measuring frequency of 3 to 20 MHz
<b>Cable capacitance</b>	<30 pF/m
<b>Wire cross-section</b>	>0.34 mm <sup>2</sup> (22 AWG)
<b>Cable type</b>	Twisted pairs
<b>Loop resistance</b>	$\leq 110\ \Omega/\text{km}$
<b>Signal damping</b>	Max. 9 dB over the entire length of the cable cross-section
<b>Shielding</b>	Copper braided shielding or braided shielding with foil shield. When grounding the cable shield, observe the grounding concept of the plant.

### Connecting cable between Safety Barrier Promass 100 and measuring device

<b>Cable type</b>	Shielded twisted-pair cable with 2x2 wires. When grounding the cable shield, observe the grounding concept of the plant.
<b>Maximum cable resistance</b>	2.5 Ω, one side

- ▶ Comply with the maximum cable resistance specifications to ensure the operational reliability of the measuring device.

The maximum cable length for individual wire cross-sections is specified in the table below. Observe the maximum capacitance and inductance per unit length of the cable and the connection values in the Ex documentation (→  76).

Wire cross-section		Maximum cable length	
[mm <sup>2</sup> ]	[AWG]	[m]	[ft]
0.5	20	70	230
0.75	18	100	328
1.0	17	100	328
1.5	16	200	656
2.5	14	300	984

#### Cable diameter

- Cable glands supplied:  
M20 × 1.5 with cable  $\phi$ 6 to 12 mm (0.24 to 0.47 in)
- Spring terminals:  
Wire cross-sections 0.5 to 2.5 mm<sup>2</sup> (20 to 14 AWG)
- With Safety Barrier Promass 100:  
Plug-in screw terminals for wire cross-sections 0.5 to 2.5 mm<sup>2</sup> (20 to 14 AWG)

### 7.1.3 Terminal assignment

#### Transmitter

*Modbus RS485 connection version, for use in intrinsically safe areas*

Order code for "Output", option **M** (connection via Safety Barrier Promass 100)

Order code for "Housing"	Connection methods available		Possible options for order code "Electrical connection"
	Output	Power supply	
Options <b>A</b>	Terminals	Terminals	<ul style="list-style-type: none"> <li>■ Option <b>B</b>: thread M20x1</li> <li>■ Option <b>C</b>: thread G ½"</li> <li>■ Option <b>D</b>: thread NPT ½"</li> </ul>
Order code for "Housing": Option <b>A</b> : compact, coated aluminum			

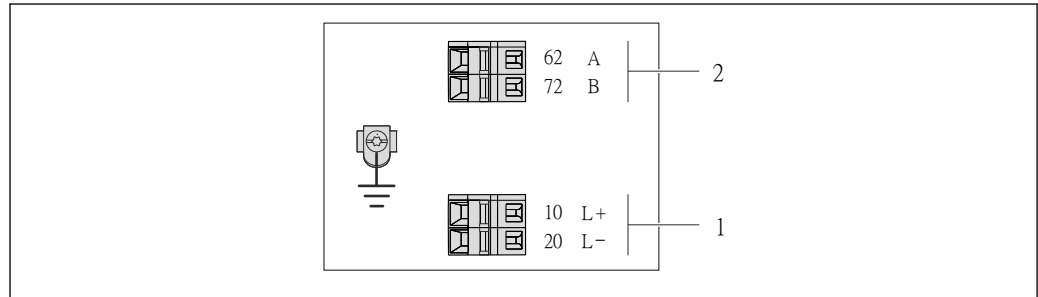

A0017053

5 *Modbus RS485 terminal assignment, connection version for use in intrinsically safe areas (connection via Safety Barrier Promass 100)*

- 1 *Intrinsically safe power supply*
- 2 *Modbus RS485*

Order code for "Output"	20 (L-)	10 (L+)	72 (B)	62 (A)
Option <b>M</b>	Intrinsically safe supply voltage		Modbus RS485 intrinsically safe	
Order code for "Output": Option <b>M</b> : Modbus RS485, for use in intrinsically safe areas (connection via Safety Barrier Promass 100)				

## Safety Barrier Promass 100

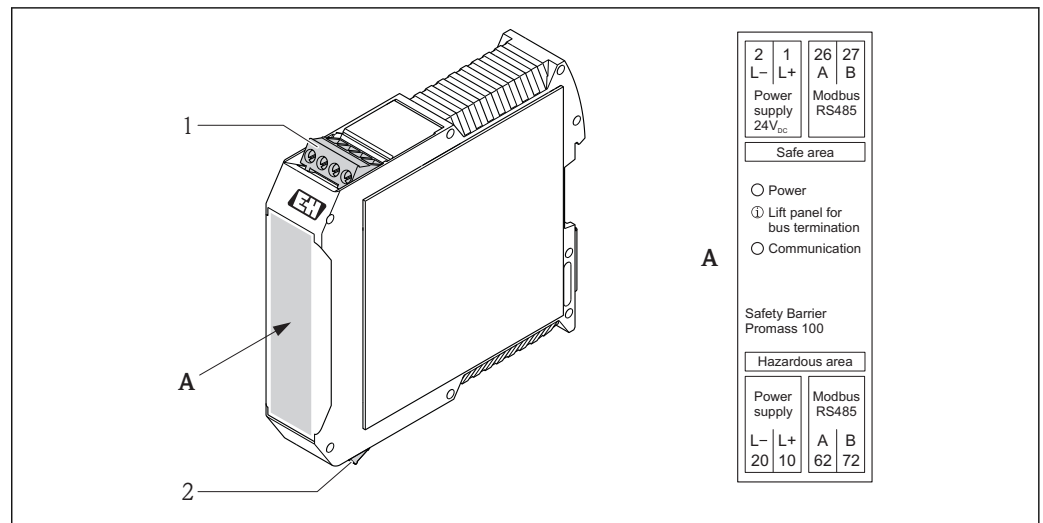

6 Safety Barrier Promass 100 with terminals

- 1 Non-hazardous area and Zone 2/Div. 2  
2 Intrinsically safe area

### 7.1.4 Shielding and grounding

The shielding and grounding concept requires compliance with the following:

- Electromagnetic compatibility (EMC)
- Explosion protection
- Personal protection equipment
- National installation regulations and guidelines
- Observe cable specification (→ 20).
- Keep the stripped and twisted lengths of cable shield to the ground terminal as short as possible.
- Seamless cable shielding.

#### Grounding of the cable shield

To comply with EMC requirements:

- Ensure the cable shield is grounded to the potential matching line at multiple points.
- Connect every local ground terminal to the potential matching line.

#### NOTICE

**In systems without potential matching, the multiple grounding of the cable shield causes mains frequency equalizing currents!**

Damage to the bus cable shield.

- ▶ Only ground the bus cable shield to either the local ground or the protective ground at one end.

### 7.1.5 Preparing the measuring device

1. Remove dummy plug if present.
2. **NOTICE!** Insufficient sealing of the housing! Operational reliability of the measuring device could be compromised. Use suitable cable glands corresponding to the degree of protection.  
If measuring device is delivered without cable glands:  
Provide suitable cable gland for corresponding connecting cable (→ 20).
3. If measuring device is delivered with cable glands:  
Observe cable specification (→ 20).

## 7.2 Connecting the measuring device

### NOTICE

#### Limitation of electrical safety due to incorrect connection!

- ▶ Have electrical connection work carried out by correspondingly trained specialists only.
- ▶ Observe applicable federal/national installation codes and regulations.
- ▶ Comply with local workplace safety regulations.
- ▶ For use in potentially explosive atmospheres, observe the information in the device-specific Ex documentation.

### 7.2.1 Connecting the transmitter

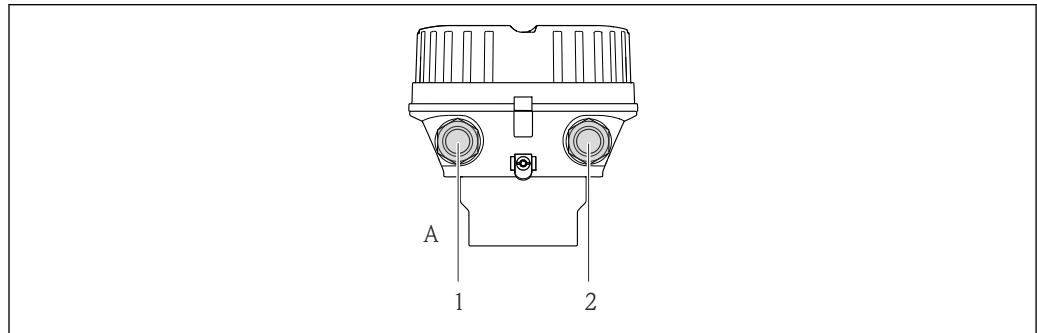

A0019824

 7 Device versions and connection versions

A Housing version: compact, aluminum coated

1 Cable entry for signal transmission

2 Cable entry for supply voltage



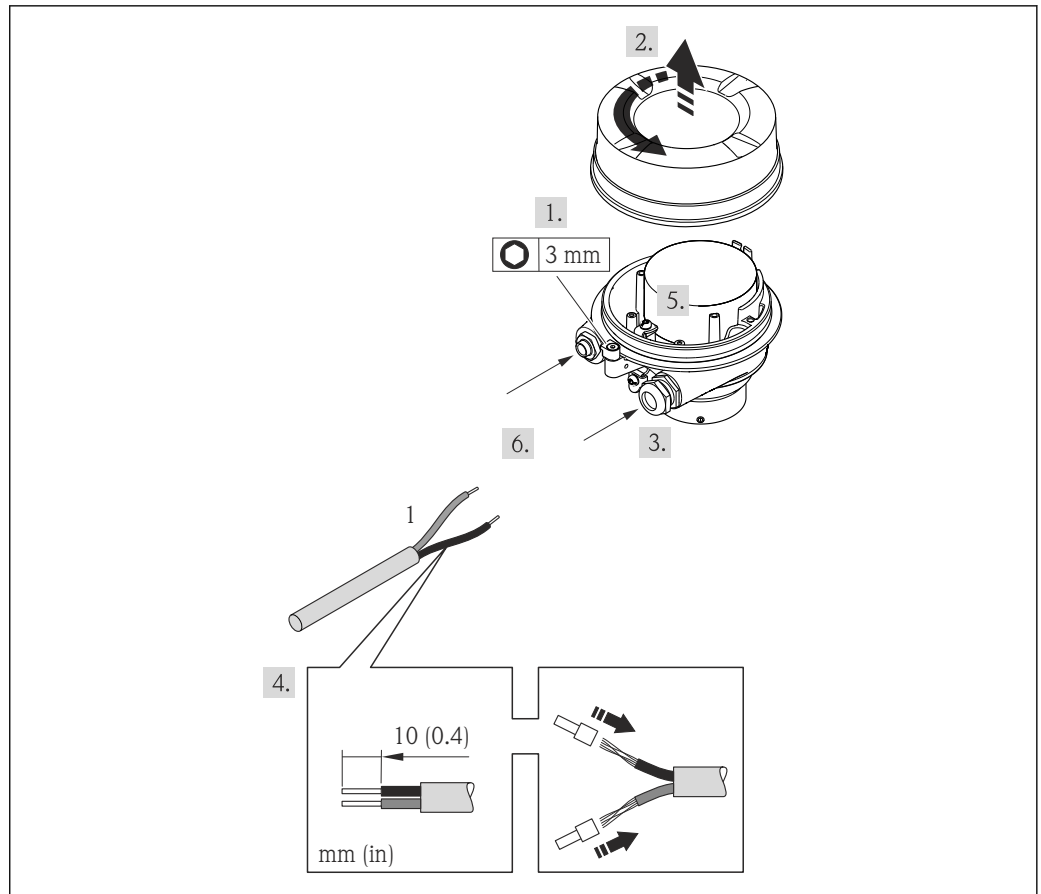

A0021923

#### 8 Device versions with connection example

##### 1 Cable

1. Loosen the securing clamp of the housing cover.
2. Unscrew the housing cover.
3. Push the cable through the cable entry . To ensure tight sealing, do not remove the sealing ring from the cable entry.
4. Strip the cable and cable ends. In the case of stranded cables, also fit ferrules.
5. Connect the cable in accordance with the terminal assignment .
6. Firmly tighten the cable glands. .
7. Enable the terminating resistor if applicable (→ 26).
8. **WARNING!** Housing degree of protection may be voided due to insufficient sealing of the housing. Screw in the screw without using any lubricant. The threads on the cover are coated with a dry lubricant.  
Reverse the removal procedure to reassemble the transmitter.

### 7.2.2 Connecting the Safety Barrier Promass 100

In the case of the device version with Modbus RS485 intrinsically safe, the transmitter must be connected to the Safety Barrier Promass 100.

1. Strip the cable ends. In the case of stranded cables, also fit ferrules.
2. Connect the cable in accordance with the terminal assignment (→ 23).
3. Where applicable, enable the terminating resistor in the Safety Barrier Promass 100 (→ 26).

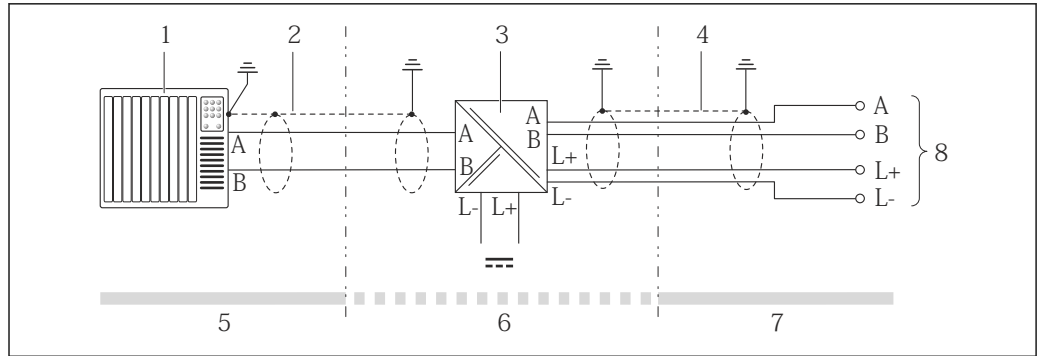

A0016804

9 Electrical connection between the transmitter and Safety Barrier Promass 100

- 1 Control system (e.g. PLC)
- 2 Observe cable specification
- 3 Safety Barrier Promass 100: terminal assignment (→ 23)
- 4 Observe cable specification (→ 20)
- 5 Non-hazardous area
- 6 Non-hazardous area and Zone 2/Div. 2
- 7 Intrinsically safe area
- 8 Transmitter: terminal assignment

## 7.3 Hardware settings

### 7.3.1 Enabling the terminating resistor

#### Modbus RS485

To avoid incorrect communication transmission caused by impedance mismatch, terminate the Modbus RS485 cable correctly at the start and end of the bus segment.

*If the transmitter is used in the intrinsically safe area*

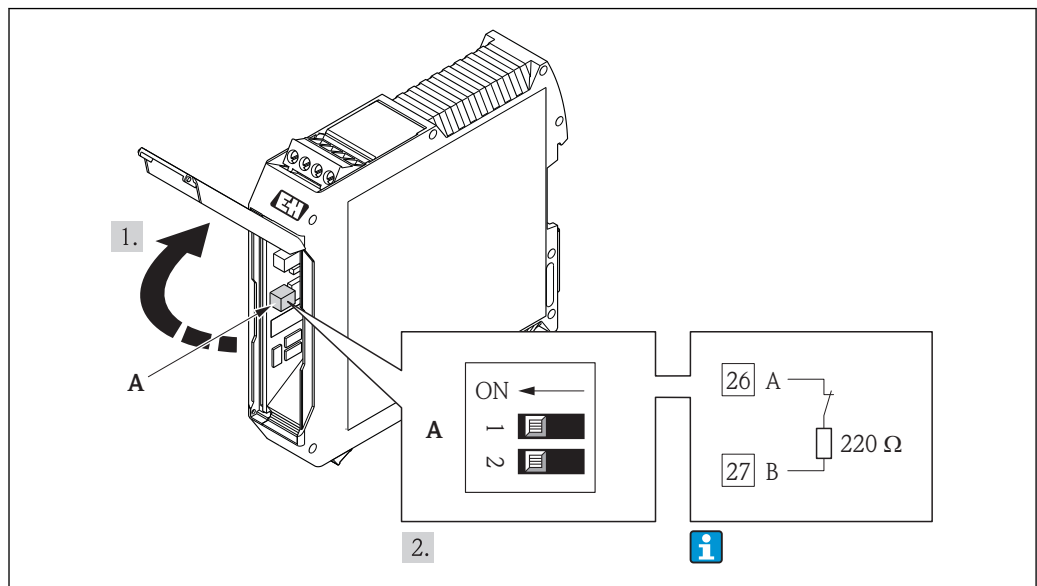

A0017791

10 Terminating resistor can be enabled via DIP switch in the Safety Barrier Promass 100

## 7.4 Ensuring the degree of protection

The measuring device fulfills all the requirements for the IP66/67 degree of protection, Type 4X enclosure.

To guarantee IP66/67 degree of protection, Type 4X enclosure, carry out the following steps after the electrical connection:

1. Check that the housing seals are clean and fitted correctly. Dry, clean or replace the seals if necessary.
2. Tighten all housing screws and screw covers.
3. Firmly tighten the cable glands.
4. To ensure that moisture does not enter the cable entry, route the cable so that it loops down before the cable entry ("water trap").

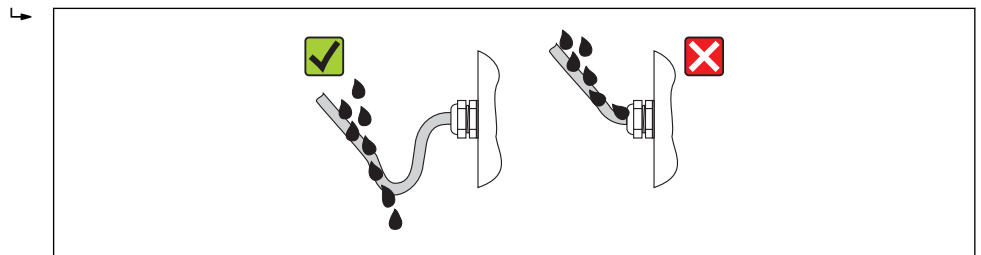

A0013960

5. Insert dummy plugs into unused cable entries.

## 7.5 Post-connection check

Are cables or the device undamaged (visual inspection)?	<input type="checkbox"/>
Do the cables comply with the requirements (→ 20)?	<input type="checkbox"/>
Do the cables have adequate strain relief?	<input type="checkbox"/>
Are all the cable glands installed, firmly tightened and leak-tight? Cable run with "water trap" (→ 27)?	<input type="checkbox"/>
<ul style="list-style-type: none"> <li>▪ Does the supply voltage match the specifications on the transmitter nameplate (→ 69)?</li> <li>▪ For device version with Modbus RS485 intrinsically safe: does the supply voltage match the specifications on the nameplate of the Safety Barrier Promass 100 (→ 69)?</li> </ul>	<input type="checkbox"/>
Is the terminal assignment correct?	<input type="checkbox"/>
<ul style="list-style-type: none"> <li>▪ If supply voltage is present, is the power LED on the electronics module of the transmitter lit green (→ 11)?</li> <li>▪ For device version with Modbus RS485 intrinsically safe, if supply voltage is present, is the power LED on the Safety Barrier Promass 100 lit (→ 11)?</li> </ul>	<input type="checkbox"/>
Depending on the device version, is the securing clamp or fixing screw firmly tightened?	<input type="checkbox"/>

## 8 Operation options

### 8.1 Overview of operation options

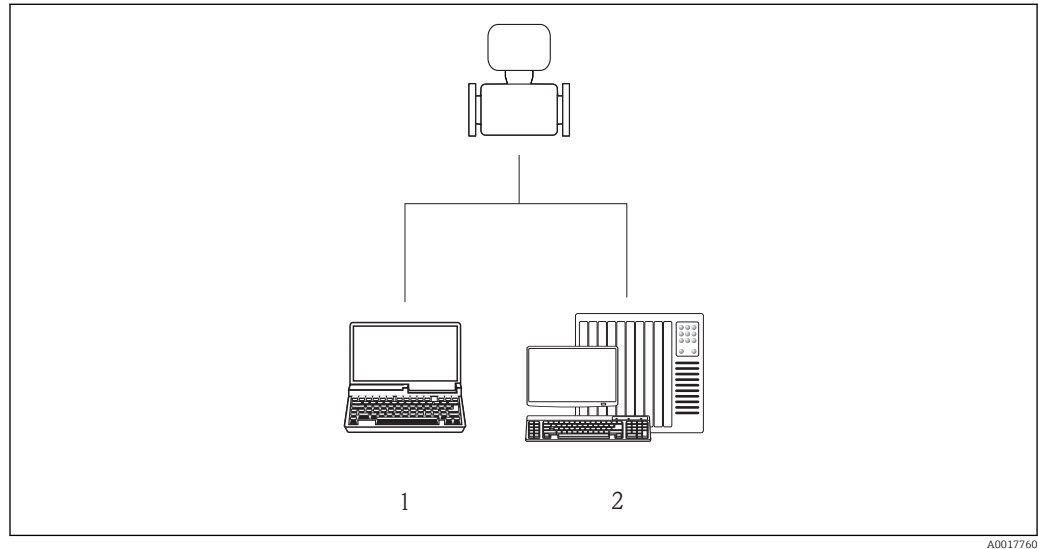



- 1 Computer with Web browser (e.g. Internet Explorer) or with "FieldCare" operating tool via Commubox FXA291 and service interface
- 2 Control system (e.g. PLC)

## 8.2 Structure and function of the operating menu

### 8.2.1 Structure of the operating menu

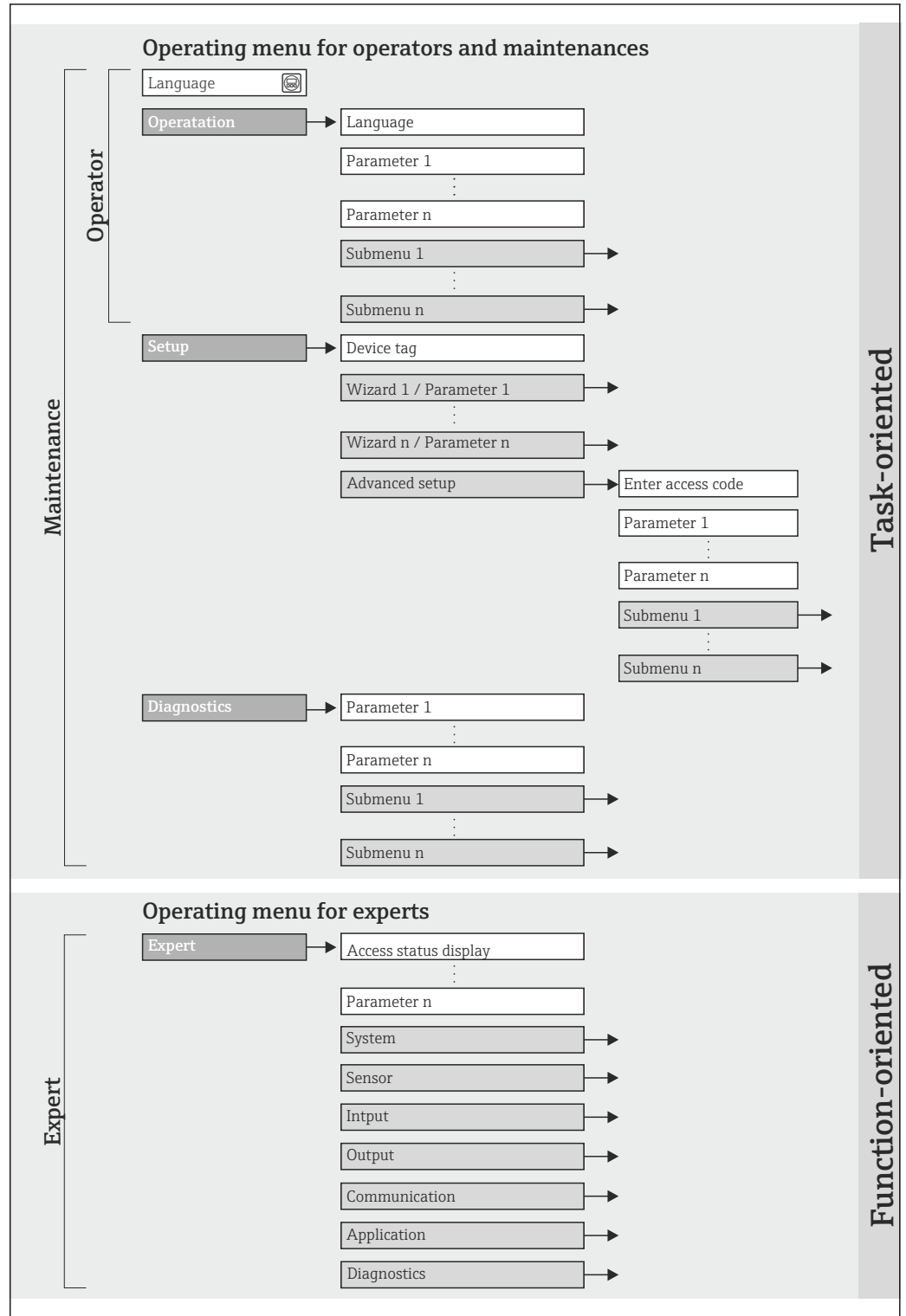
 For an overview of the operating menu with menus and parameters (→  77)



 11 Schematic structure of the operating menu

A0018237-EN

### 8.2.2 Operating philosophy

The individual parts of the operating menu are assigned to certain user roles. Each user role corresponds to typical tasks within the device lifecycle.

Menu		User role and tasks	Content/meaning
Operation	task-oriented	<b>Role "Operator", "Maintenance"</b> Tasks during operation: Reading measured values	Resetting and controlling totalizers
Setup		<b>"Maintenance" role</b> Commissioning: <ul style="list-style-type: none"> <li>▪ Configuration of the measurement</li> <li>▪ Configuration of the communication interface</li> </ul>	Submenus for fast commissioning: <ul style="list-style-type: none"> <li>▪ Setting the individual system units</li> <li>▪ Defining the medium</li> <li>▪ Configuration of the digital communication interface</li> <li>▪ Configuring the low flow cut off</li> <li>▪ Configuring the monitoring of partial and empty pipe detection</li> </ul> <b>"Advanced setup" submenu:</b> <ul style="list-style-type: none"> <li>▪ For more customized configuration of the measurement (adaptation to special measuring conditions)</li> <li>▪ Configuration of totalizers</li> </ul> <b>"Device reset" submenu</b> Resets the device configuration to certain settings
Diagnostics		<b>"Maintenance" role</b> Fault elimination: <ul style="list-style-type: none"> <li>▪ Diagnostics and elimination of process and device errors</li> <li>▪ Measured value simulation</li> </ul>	Contains all parameters for error detection and analyzing process and device errors: <ul style="list-style-type: none"> <li>▪ <b>"Diagnostic list" submenu</b> Contains up to 5 currently pending diagnostic messages.</li> <li>▪ <b>"Event logbook" submenu</b> Contains 20 event messages that have occurred.</li> <li>▪ <b>"Device information" submenu</b> Contains information for identifying the device.</li> <li>▪ <b>"Measured values" submenu</b> Contains all current measured values.</li> <li>▪ <b>"Simulation" submenu</b> Is used to simulate measured values or output values.</li> </ul>
Expert	function-oriented	Tasks that require detailed knowledge of the function of the device: <ul style="list-style-type: none"> <li>▪ Commissioning measurements under difficult conditions</li> <li>▪ Optimal adaptation of the measurement to difficult conditions</li> <li>▪ Detailed configuration of the communication interface</li> <li>▪ Error diagnostics in difficult cases</li> </ul>	Contains all the parameters of the device and makes it possible to access these parameters directly using an access code. The structure of this menu is based on the function blocks of the device: <ul style="list-style-type: none"> <li>▪ <b>"System" submenu</b> Contains all higher-order device parameters that do not pertain either to measurement or the measured value communication.</li> <li>▪ <b>"Sensor" submenu</b> Configuration of the measurement.</li> <li>▪ <b>"Communication" submenu</b> Configuration of the digital communication interface.</li> <li>▪ <b>"Application" submenu</b> Configuration of the functions that go beyond the actual measurement (e.g. totalizer).</li> <li>▪ <b>"Diagnostics" submenu</b> Error detection and analysis of process and device errors and for device simulation and Heartbeat Technology.</li> </ul>

## 8.3 Access to the operating menu via the operating tool

### 8.3.1 Connecting the operating tool

#### Via service interface (CDI)

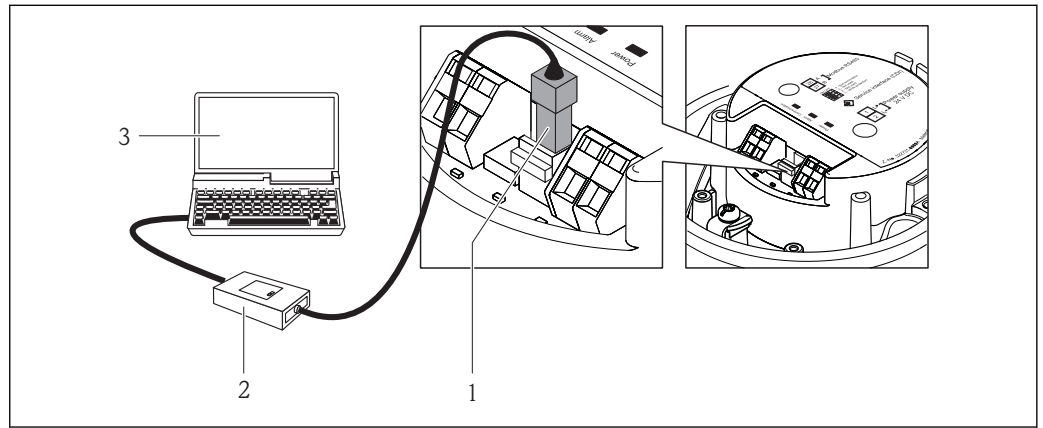

- 1 Service interface (CDI) of the measuring device  
 2 Commubox FXA291  
 3 Computer with "FieldCare" operating tool with COM DTM "CDI Communication FXA291"

### 8.3.2 FieldCare

#### Function scope

FDT-based plant asset management tool from Endress+Hauser. It can configure all smart field devices in a system and helps you manage them. By using the status information, it is also a simple but effective way of checking their status and condition.

Access takes place via:

Service interface CDI (→ 31)

Typical functions:

- Configuring parameters of transmitters
- Loading and saving device data (upload/download)
- Documentation of the measuring point
- Visualization of the measured value memory (line recorder) and event logbook

For details, see Operating Instructions BA00027S and BA00059S

#### Source for device description files

See data (→ 33)

#### Establishing a connection

Via service interface (CDI)

1. Start FieldCare and launch the project.
2. In the network: Add a device.
  - ↳ The **Add device** window opens.
3. Select the **CDI Communication FXA291** option from the list and press **OK** to confirm.
4. Right-click **CDI Communication FXA291** and select the **Add device** option in the context menu that opens.



5. Select the desired device from the list and press **OK** to confirm.
6. Establish the online connection to the device.

 For details, see Operating Instructions BA00027S and BA00059S

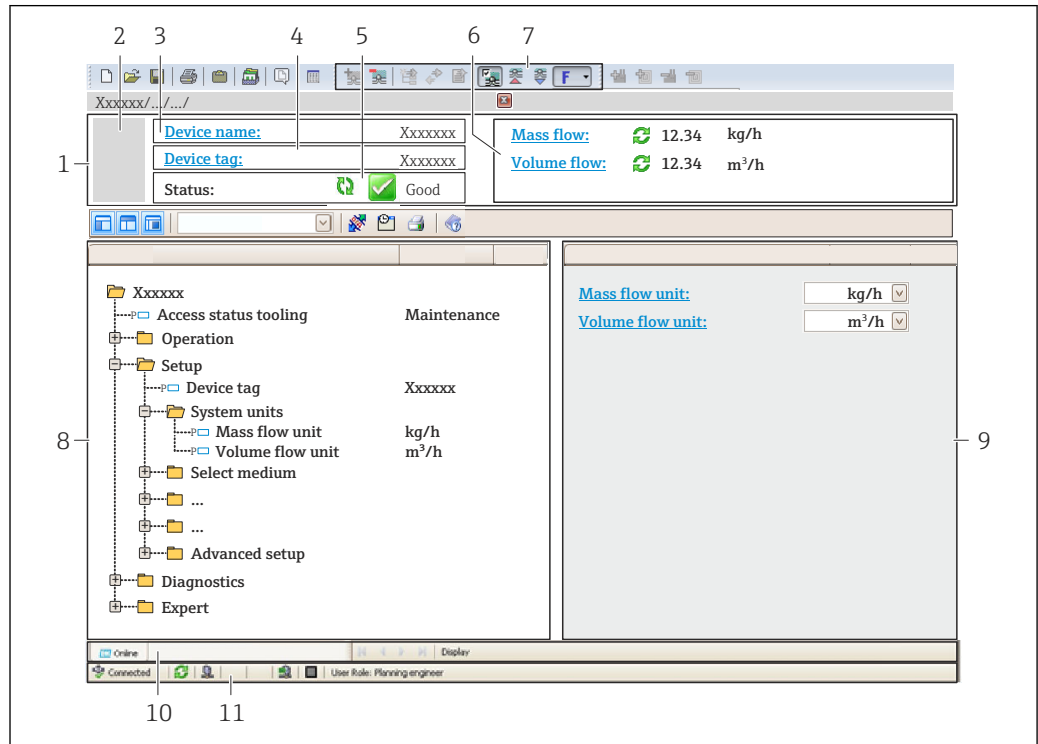
**User interface**



A0021051-EN

- 1 Header
- 2 Picture of device
- 3 Device name
- 4 Device tag (→  37)
- 5 Status area with status signal (→  55)
- 6 Display area for current measured values (→  50)
- 7 Event list with additional functions such as save/load, events list and document creation
- 8 Navigation area with operating menu structure
- 9 Operating range
- 10 Range of action
- 11 Status area



## 9 System integration

### 9.1 Overview of device description files

#### 9.1.1 Current version data for the device

Firmware version	01.02.00	<ul style="list-style-type: none"> <li>▪ On the title page of the Operating instructions</li> <li>▪ On transmitter nameplate (→  13)</li> <li>▪ Parameter <b>firmware version</b> Diagnostics → Device info → Firmware version</li> </ul>
Release date of firmware version	04.2013	---

#### 9.1.2 Operating tools



The suitable device description file for the operating tool is listed in the table below, along with information on where the file can be acquired.



Operating tool via service interface (CDI)	Sources for obtaining device descriptions
FieldCare	<ul style="list-style-type: none"> <li>▪ <a href="http://www.endress.com">www.endress.com</a> → Download Area</li> <li>▪ CD-ROM (contact Endress+Hauser)</li> <li>▪ DVD (contact Endress+Hauser)</li> </ul>

## 9.2 Modbus RS485 information

### 9.2.1 Function codes



Function codes are used to define which read or write action is carried out via the Modbus protocol. The measuring device supports the following function codes:

Code	Name	Description	Application
03	Read holding register	<p>Master reads one or more Modbus registers from the device. A maximum of 125 consecutive registers can be read with 1 telegram: 1 register = 2 bytes</p> <p> The measuring device does not make a distinction between function codes 03 and 04; these codes therefore yield the same result.</p>	<p>Read device parameters with read and write access</p> <p>Example: Read mass flow</p>
04	Read input register	<p>Master reads one or more Modbus registers from the device. A maximum of 125 consecutive registers can be read with 1 telegram: 1 register = 2 bytes</p> <p> The measuring device does not make a distinction between function codes 03 and 04; these codes therefore yield the same result.</p>	<p>Read device parameters with read access</p> <p>Example: Read totalizer value</p>

Code	Name	Description	Application
06	Write single registers	Master writes a new value to <b>one</b> Modbus register of the measuring device.  Use function code 16 to write multiple registers with just 1 telegram.	Write only 1 device parameter Example: reset totalizer
08	Diagnostics	Master checks the communication connection to the measuring device. The following "Diagnostics codes" are supported: <ul style="list-style-type: none"> <li>▪ Sub-function 00 = Return query data (loopback test)</li> <li>▪ Sub-function 02 = Return diagnostics register</li> </ul>	
16	Write multiple registers	Master writes a new value to multiple Modbus registers of the device. A maximum of 120 consecutive registers can be written with 1 telegram.  If the required device parameters are not available as a group, yet must nevertheless be addressed with a single telegram, use Modbus data map (→  34)	Write multiple device parameters Example: <ul style="list-style-type: none"> <li>▪ Mass flow unit</li> <li>▪ Mass unit</li> </ul>
23	Read/Write multiple registers	Master reads and writes a maximum of 118 Modbus registers of the measuring device simultaneously with 1 telegram. Write access is executed <b>before</b> read access.	Write and read multiple device parameters Example: <ul style="list-style-type: none"> <li>▪ Read mass flow</li> <li>▪ Reset totalizer</li> </ul>

 Broadcast messages are only allowed with function codes 06, 16 and 23.

### 9.2.2 Register information

 For an overview on Modbus-specific information of the individual device parameters, please refer to the additional document on Modbus RS485 register information (→  76)

### 9.2.3 Response time

Response time of the measuring device to the request telegram of the Modbus master: typically 3 to 5 ms

### 9.2.4 Modbus data map

#### Function of the Modbus data map



The device offers a special memory area, the Modbus data map (for a maximum of 16 device parameters), to allow users to call up multiple device parameters via Modbus RS485 and not only individual device parameters or a group of consecutive device parameters.

Grouping of device parameters is flexible and the Modbus master can read or write to the entire data block simultaneously with a single request telegram.

### Structure of the Modbus data map

The Modbus data map consists of two data sets:

- Scan list: Configuration area  
The device parameters to be grouped are defined in a list in that their Modbus RS485 register addresses are entered in the list.
- Data area  
The measuring device reads out the register addresses entered in the scan list cyclically and writes the associated device data (values) to the data area.

 For an overview of device parameters with their individual Modbus register address, please refer to the additional document on Modbus RS485 register information (→  76)

### Scan list configuration

For configuration, the Modbus RS485 register addresses of the device parameters to be grouped must be entered in the scan list. Please note the following basic requirements of the scan list:

<b>Max. entries</b>	16 device parameters
<b>Supported device parameters</b>	Only parameters with the following characteristics are supported: <ul style="list-style-type: none"> <li>■ Access type: read or write access</li> <li>■ Data type: float or integer</li> </ul>

#### Configuring the scan list via FieldCare

Carried out using the operating menu of the measuring device:  
Expert → Communication → Modbus data map → Scan list register 0 -15

Scan list	
No.	Configuration register
0	Scan list register 0
...	...
15	Scan list register 15

#### Configuring the scan list via Modbus RS485

Carried out using register addresses 5001 - 5016

Scan list			
No.	Modbus RS485 register	Data type	Configuration register
0	5001	Integer	Scan list register 0
...	...	Integer	...
15	5016	Integer	Scan list register 15

### Reading out data via Modbus RS485

The Modbus master accesses the data area of the Modbus data map to read out the current values of the device parameters defined in the scan list.

<b>Master access to data area</b>	Via register addresses 5051-5081
-----------------------------------	----------------------------------

<b>Data area</b>			
<b>Device parameter value</b>	<b>Modbus RS485 register</b>	<b>Data type*</b>	<b>Access**</b>
Value of scan list register 0	5051	Integer/float	Read/write
Value of scan list register 1	5053	Integer/float	Read/write
Value of scan list register ...	...	...	...
Value of scan list register 15	5081	Integer/float	Read/write
* Data type depends on the device parameters entered in the scan list. ** Data access depends on the device parameters entered in the scan list. If the device parameter entered supports read and write access, the parameter can also be accessed via the data area.			



## 10 Commissioning

### 10.1 Function check

Before commissioning the device, make sure that the post-installation and post-connection checks have been performed.

- "Post-installation check" checklist (→  19)
- "Post-connection check" checklist (→  27)

### 10.2 Establishing a connection via FieldCare

- For FieldCare connection (→  31)
- For establishing a connection via FieldCare (→  31)
- For FieldCare user interface (→  32)

### 10.3 Configuring the measuring device

The **Setup** menu with its submenus contains all the parameters needed for standard operation.

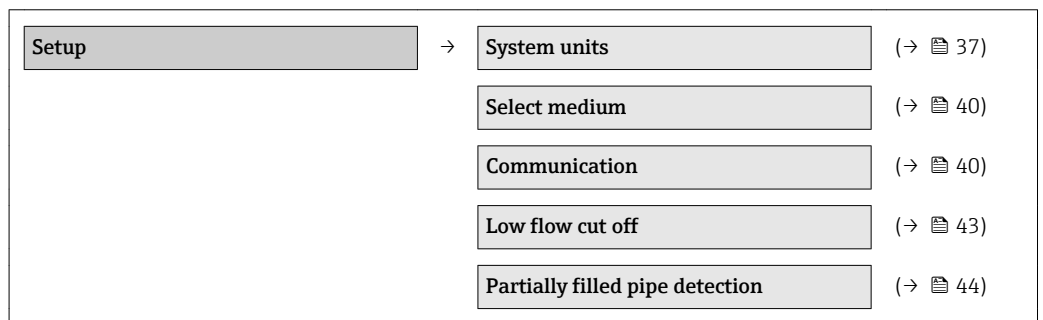

Structure of the "Setup" menu



#### 10.3.1 Defining the tag name

To enable fast identification of the measuring point within the system, you can enter a unique designation using the **Device tag** parameter and thus change the factory setting.

 The number of characters displayed depends on the characters used.

 For information on the tag name in the "FieldCare" operating tool (→  32)

#### Navigation

"Setup" menu → Advanced setup → Device tag

#### Parameter overview with brief description

Parameter	Description	User entry	Factory setting
Device tag	Enter the name for the measuring point.	Max. 32 characters, such as letters, numbers or special characters (e.g. @, %, /).	CNGmass

#### 10.3.2 Setting the system units

In the **System units** submenu the units of all the measured values can be set.

Structure of the submenu

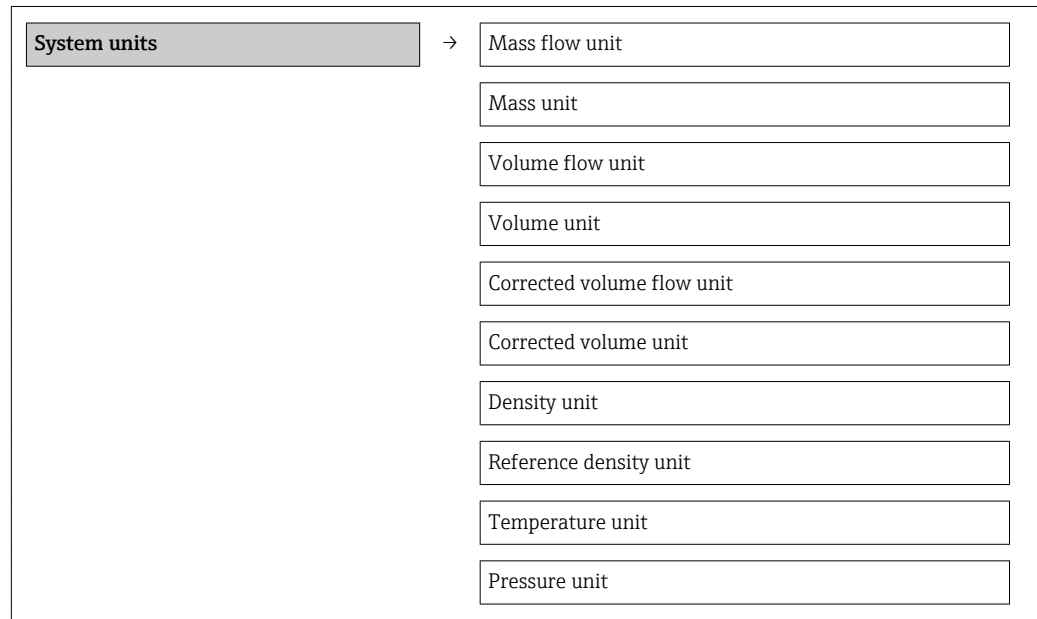

Parameter overview with brief description

Parameter	Description	Selection	Factory setting
Mass flow unit	Select mass flow unit. <i>Result</i> The selected unit applies for: <ul style="list-style-type: none"> <li>▪ Output</li> <li>▪ Low flow cut off</li> <li>▪ Simulation process variable</li> </ul>	Unit choose list	Country-specific: <ul style="list-style-type: none"> <li>▪ kg/h</li> <li>▪ lb/min</li> </ul>
Mass unit	Select mass unit. <i>Result</i> The selected unit is taken from: <b>Mass flow unit</b> parameter	Unit choose list	Country-specific: <ul style="list-style-type: none"> <li>▪ kg</li> <li>▪ lb</li> </ul>
Volume flow unit	Select volume flow unit. <i>Result</i> The selected unit applies for: <ul style="list-style-type: none"> <li>▪ Output</li> <li>▪ Low flow cut off</li> <li>▪ Simulation process variable</li> </ul>	Unit choose list	Country-specific: <ul style="list-style-type: none"> <li>▪ l/h</li> <li>▪ gal/min (us)</li> </ul>
Volume unit	Select volume unit. <b>Result</b> The selected unit is taken from: <b>Volume flow unit</b> parameter	Unit choose list	Country-specific: <ul style="list-style-type: none"> <li>▪ l</li> <li>▪ gal (us)</li> </ul>
Corrected volume flow unit	Select corrected volume flow unit. <i>Result</i> The selected unit applies for: <ul style="list-style-type: none"> <li>▪ Output</li> <li>▪ Low flow cut off</li> <li>▪ Simulation process variable</li> </ul>	Unit choose list	Country-specific: <ul style="list-style-type: none"> <li>▪ NI/h</li> <li>▪ Sft<sup>3</sup>/h</li> </ul>
Corrected volume unit	Select corrected volume unit. <b>Result</b> The selected unit is taken from: <b>Corrected volume flow unit</b> parameter	Unit choose list	Country-specific: <ul style="list-style-type: none"> <li>▪ NI</li> <li>▪ Sft<sup>3</sup></li> </ul>

Parameter	Description	Selection	Factory setting
Density unit	Select density unit. <i>Result</i> The selected unit applies for: <ul style="list-style-type: none"> <li>▪ Output</li> <li>▪ Simulation process variable</li> <li>▪ Density adjustment (in <b>Expert</b> menu)</li> </ul>	Unit choose list	Country-specific: <ul style="list-style-type: none"> <li>▪ kg/l</li> <li>▪ lb/ft<sup>3</sup></li> </ul>
Reference density unit	Select reference density unit.	Unit choose list	kg/Nl
Temperature unit	Select temperature unit. <i>Result</i> The selected unit applies for: <ul style="list-style-type: none"> <li>▪ Output</li> <li>▪ Reference temperature</li> <li>▪ Simulation process variable</li> </ul>	Unit choose list	Country-specific: <ul style="list-style-type: none"> <li>▪ °C (Celsius)</li> <li>▪ °F (Fahrenheit)</li> </ul>
Pressure unit	Select process pressure unit.	Unit choose list	Country-specific: <ul style="list-style-type: none"> <li>▪ bar</li> <li>▪ psi</li> </ul>

### 10.3.3 Selecting and setting the medium

The **Medium selection** submenu contains parameters that have to be configured for selecting and setting the medium.

#### Navigation

"Setup" menu → Select medium

Select medium	→	Select medium
		Select gas type
		Reference sound velocity
		Temperature coefficient sound velocity
		Pressure compensation
		Pressure value
		External pressure

#### Parameter overview with brief description

Parameter	Prerequisite	Description	Selection / User entry	Factory setting
Select medium	–	Select medium type.	Gas	Liquid
Select gas type	The following option is selected in the <b>Medium selection</b> parameter: Gas	Select measured gas type.	Gas type choose list	Methane CH <sub>4</sub>
Reference sound velocity	The following option is selected in the <b>Select gas type</b> parameter: Others	Enter sound velocity of gas at 0 °C (32 °F).	1 to 99 999.9999 m/s	0 m/s
Temperature coefficient sound velocity	The following option is selected in the <b>Select gas type</b> parameter: Others	Enter temperature coefficient for the gas sound velocity.	Positive floating-point number	0 (m/s)/K
Pressure compensation	The following option is selected in the <b>Medium selection</b> parameter: Gas	Select pressure compensation type.	<ul style="list-style-type: none"> <li>▪ Off</li> <li>▪ Fixed value</li> <li>▪ External value</li> </ul>	Off
Pressure value	The following option is selected in the <b>Pressure compensation</b> parameter: Fixed value	Enter process pressure to be used for pressure correction.	Positive floating-point number	0 bar a
External pressure	The following option is selected in the <b>Pressure compensation</b> parameter: External value		Positive floating-point number	0 bar a

### 10.3.4 Configuring the communication interface

The "**Communication**" submenu guides you systematically through all the parameters that have to be configured for selecting and setting the communication interface.

#### Navigation

"Setup" menu → Communication



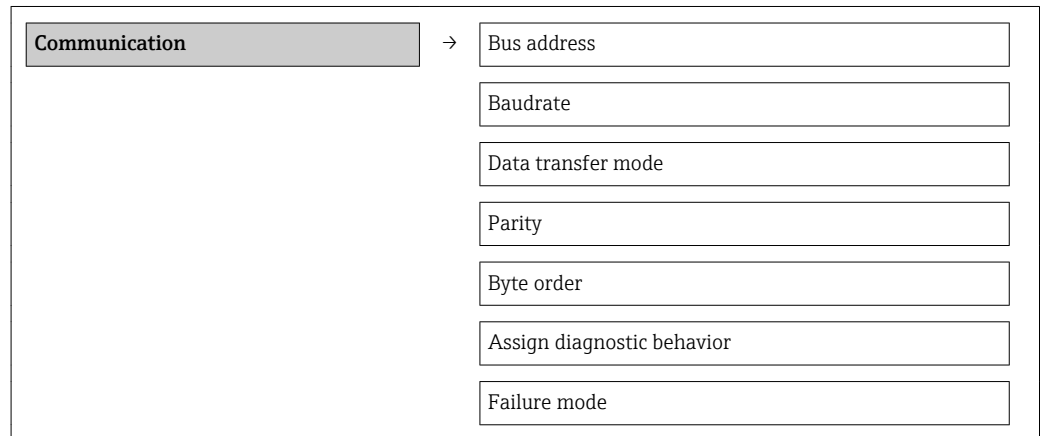

**Structure of the submenu**



**Parameter overview with brief description**

Parameter	Description	User entry / Selection	Factory setting
Bus address	Enter device address.	1 to 247	247
Baudrate	Define data transfer speed.	<ul style="list-style-type: none"> <li>■ 1200 BAUD</li> <li>■ 2400 BAUD</li> <li>■ 4800 BAUD</li> <li>■ 9600 BAUD</li> <li>■ 19200 BAUD</li> <li>■ 38400 BAUD</li> <li>■ 57600 BAUD</li> <li>■ 115200 BAUD</li> </ul>	19200 BAUD
Data transfer mode	Select data transfer mode.	<ul style="list-style-type: none"> <li>■ ASCII Transmission of data in the form of readable ASCII characters. Error protection via LRC.</li> <li>■ RTU Transmission of data in binary form. Error protection via CRC16.</li> </ul>	RTU
Parity	Select parity bits.	ASCII picklist <ul style="list-style-type: none"> <li>■ 0 = even</li> <li>■ 1 = odd</li> </ul> RTU picklist <ul style="list-style-type: none"> <li>■ 0 = even</li> <li>■ 1 = odd</li> <li>■ 2 = no parity bit/1 stop bit</li> <li>■ 3 = no parity bit/2 stop bits</li> </ul>	Even
Byte order	Select byte transmission sequence.	<ul style="list-style-type: none"> <li>■ 0-1-2-3</li> <li>■ 3-2-1-0</li> <li>■ 1-0-3-2</li> <li>■ 2-3-0-1</li> </ul>	1-0-3-2

Parameter	Description	User entry / Selection	Factory setting
Assign diagnostic behavior	Select diagnostic behavior for MODBUS communication.	<ul style="list-style-type: none"> <li>■ Off</li> <li>■ Alarm or warning</li> <li>■ Warning</li> <li>■ Alarm</li> </ul>	Alarm
Failure mode	<p>Select measured value output behavior when a diagnostic message occurs via Modbus communication.</p> <p> This parameter operates in accordance with the option selected in the <b>Assign diagnostic behavior</b> parameter.</p> <p> NaN: not a number</p>	<ul style="list-style-type: none"> <li>■ NaN value</li> <li>■ Last valid value</li> </ul>	NaN value

### 10.3.5 Configuring the low flow cut off

The **Low flow cut off** submenu contains parameters that must be configured for the configuration of low flow cut off.

#### Navigation

"Setup" menu → Low flow cut off

Low flow cut off	→	Assign process variable
		On value low flow cutoff
		Off value low flow cutoff
		Pressure shock suppression

#### Parameter overview with brief description

Parameter	Prerequisite	Description	Selection / User entry	Factory setting
Assign process variable	–	Select process variable for low flow cut off.	<ul style="list-style-type: none"> <li>■ Off</li> <li>■ Mass flow</li> <li>■ Volume flow</li> <li>■ Corrected volume flow</li> </ul>	Mass flow
On value low flow cutoff	One of the following options is selected in the <b>Assign process variable</b> parameter: <ul style="list-style-type: none"> <li>■ Mass flow</li> <li>■ Volume flow</li> <li>■ Corrected volume flow</li> </ul>	Enter on value for low flow cut off.	Positive floating-point number	For liquids: depends on country and nominal diameter
Off value low flow cutoff	One of the following options is selected in the <b>Assign process variable</b> parameter: <ul style="list-style-type: none"> <li>■ Mass flow</li> <li>■ Volume flow</li> <li>■ Corrected volume flow</li> </ul>	Enter off value for low flow cut off.	0 to 100.0 %	50 %
Pressure shock suppression	One of the following options is selected in the <b>Assign process variable</b> parameter: <ul style="list-style-type: none"> <li>■ Mass flow</li> <li>■ Volume flow</li> <li>■ Corrected volume flow</li> </ul>	Enter time frame for signal suppression (= active pressure shock suppression).	0 to 100 s	0 s

### 10.3.6 Configuring the partial filled pipe detection

The **Partially filled pipe detection** submenu contains parameters that have to be set for configuring empty pipe detection.

#### Navigation

"Setup" menu → Partially filled pipe detection

<b>Partially filled pipe detection</b>	→	Assign process variable
		Low value partial filled pipe detection
		High value partial filled pipe detection
		Response time part. filled pipe detect.

#### Parameter overview with brief description

Parameter	Prerequisite	Description	Selection / User entry	Factory setting
Assign process variable	–	Select process variable for partially filled pipe detection.	<ul style="list-style-type: none"> <li>■ Off</li> <li>■ Density</li> <li>■ Reference density</li> </ul>	Off
Low value partial filled pipe detection	One of the following options is selected in the <b>Assign process variable</b> parameter: <ul style="list-style-type: none"> <li>■ Density</li> <li>■ Reference density</li> </ul>	Enter lower limit value for deactivating partially filled pipe detection.	Signed floating-point number	Country-dependent: <ul style="list-style-type: none"> <li>■ 0.2 kg/l</li> <li>■ 12.5 lb/ft<sup>3</sup></li> </ul>
High value partial filled pipe detection	One of the following options is selected in the <b>Assign process variable</b> parameter: <ul style="list-style-type: none"> <li>■ Density</li> <li>■ Reference density</li> </ul>	Enter upper limit value for deactivating partially filled pipe detection.	Signed floating-point number	Country-dependent: <ul style="list-style-type: none"> <li>■ 6 kg/l</li> <li>■ 374.6 lb/ft<sup>3</sup></li> </ul>
Response time part. filled pipe detect.	One of the following options is selected in the <b>Assign process variable</b> parameter: <ul style="list-style-type: none"> <li>■ Density</li> <li>■ Reference density</li> </ul>	Enter time before diagnostic message is displayed for partially filled pipe detection.	0 to 100 s	1 s

## 10.4 Advanced settings

The **Advanced setup** submenu with its submenus contains parameters for specific settings.

### Navigation

"Setup" menu → Advanced setup

### Overview of the parameters and submenus in the "Advanced setup" submenu:

Taking the example of the Web browser

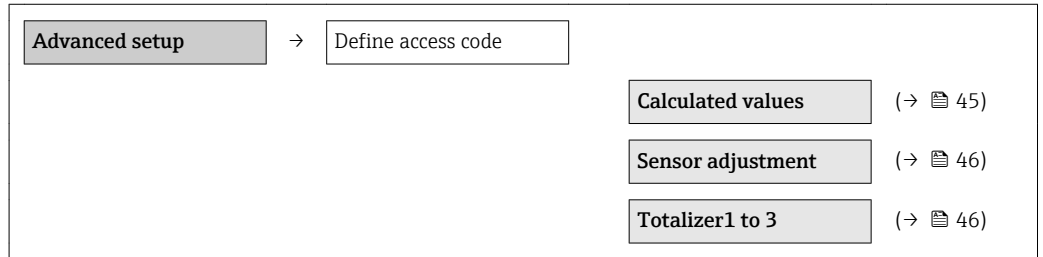

### 10.4.1 Calculated values

The **Calculated values** submenu contains parameters for calculating the corrected volume flow.

### Navigation

"Setup" menu → Advanced setup → Calculated values

Structure of the submenu

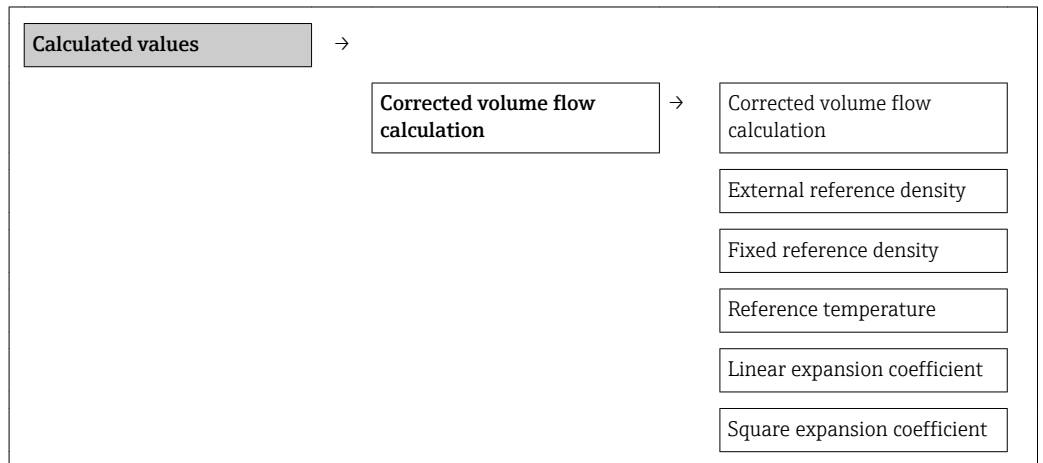

### Parameter overview with brief description

Parameter	Prerequisite	Description	Selection / User entry	Factory setting
Corrected volume flow calculation	–	Select reference density for calculating the corrected volume flow.	<ul style="list-style-type: none"> <li>■ Fixed reference density</li> <li>■ Calculated reference density</li> <li>■ Reference density by API table 53</li> <li>■ External reference density</li> </ul>	Calculated reference density
External reference density	–	Shows external reference density.	Floating point number with sign	0 kg/Nl

Parameter	Prerequisite	Description	Selection / User entry	Factory setting
Fixed reference density	The following option is selected in the <b>Corrected volume flow calculation</b> parameter: Fixed reference density	Enter fixed value for reference density.	Positive floating-point number	0.001 kg/Nl
Reference temperature	The following option is selected in the <b>Corrected volume flow calculation</b> parameter: Calculated reference density	Enter reference temperature for calculating the reference density.	-273.15 to 99 999 °C	20 °C
Linear expansion coefficient	The following option is selected in the <b>Corrected volume flow calculation</b> parameter: Calculated reference density	Enter linear, medium-specific expansion coefficient for calculating the reference density.	Signed floating-point number	0.0
Square expansion coefficient	–	For media with a non-linear expansion pattern: enter the quadratic, medium-specific expansion coefficient for calculating the reference density.	Signed floating-point number	0.0

### 10.4.2 Carrying out a sensor adjustment

The **Sensor adjustment** submenu contains parameters that pertain to the functionality of the sensor.

#### Navigation

"Setup" menu → Advanced setup → Sensor adjustment

*Structure of the submenu*

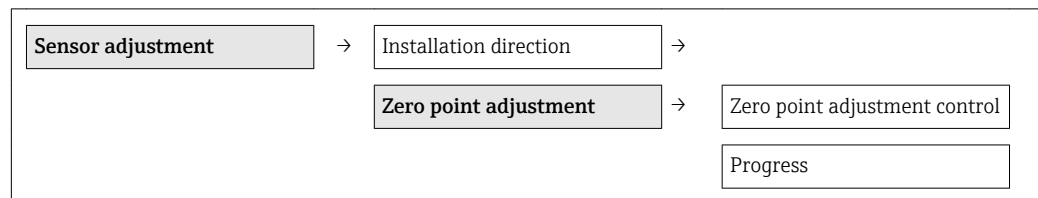

#### Parameter overview with brief description

Parameter	Description	Selection / User interface	Factory setting
Installation direction	Set sign of flow direction to match the direction of the arrow on the sensor.	<ul style="list-style-type: none"> <li>▪ Flow in arrow direction</li> <li>▪ Flow against arrow direction</li> </ul>	Flow in arrow direction
Zero point adjustment control	Start zero point adjustment.	<ul style="list-style-type: none"> <li>▪ Cancel</li> <li>▪ Busy</li> <li>▪ Zero point adjust failure</li> <li>▪ Start</li> </ul>	Cancel
Progress	Shows the progress of the process.	0 to 100 %	0 %

### 10.4.3 Configuring the totalizer

In the **"Totalizer 1 to 3"** submenu the individual totalizers can be configured.

**Navigation**

"Setup" menu → Advanced setup → Totalizer 1 to 3

<b>Totalizer 1 to 3</b>	→	Assign process variable
		Mass unit
		Volume unit
		Corrected volume unit
		Totalizer operation mode
		Failure mode

**Parameter overview with brief description**

Parameter	Description	Selection	Factory setting
Assign process variable	Select process variable for totalizer.	<ul style="list-style-type: none"> <li>▪ Off</li> <li>▪ Mass flow</li> <li>▪ Volume flow</li> <li>▪ Corrected volume flow</li> <li>▪ Target mass flow</li> <li>▪ Carrier mass flow</li> </ul>	Mass flow
Mass unit	Select mass unit.	Unit choose list	kg
Volume unit	Select volume unit.	Unit choose list	m <sup>3</sup>
Corrected volume unit	Select corrected volume unit.	Unit choose list	Nm <sup>3</sup>
Totalizer operation mode	Select totalizer calculation mode.	<ul style="list-style-type: none"> <li>▪ Net flow total</li> <li>▪ Forward flow total</li> <li>▪ Reverse flow total</li> </ul>	Net flow total
Failure mode	Define totalizer behavior in alarm condition.	<ul style="list-style-type: none"> <li>▪ Stop</li> <li>▪ Actual value</li> <li>▪ Last valid value</li> </ul>	Stop

**10.5 Simulation**

The "**Simulation**" submenu enables you to simulate, without a real flow situation, various process variables in the process and the device alarm mode and to verify downstream signal chains (switching valves or closed-control loops).

**Navigation**

"Diagnostics" menu → Simulation

<b>Simulation</b>	→	Assign simulation process variable
		Value process variable
		Simulation device alarm
		Simulation diagnostic event

### Parameter overview with brief description

Parameter	Prerequisite	Description	Selection / User entry	Factory setting
Assign simulation process variable	–	Select a process variable for the simulation process that is activated.	<ul style="list-style-type: none"> <li>▪ Off</li> <li>▪ Mass flow</li> <li>▪ Volume flow</li> <li>▪ Corrected volume flow</li> <li>▪ Density</li> <li>▪ Reference density</li> <li>▪ Temperature</li> <li>▪ Dynamic viscosity</li> <li>▪ Kinematic viscosity</li> <li>▪ Temp. compensated dynamic viscosity</li> <li>▪ Temp. compensated kinematic viscosity</li> <li>▪ Concentration</li> <li>▪ Target mass flow</li> <li>▪ Carrier mass flow</li> </ul>	Off
Value process variable	A process variable is selected in the <b>Assign simulation process variable</b> parameter.	Enter the simulation value for the selected process variable.	Signed floating-point number	0
Simulation device alarm	–	Switch the device alarm on and off.	<ul style="list-style-type: none"> <li>▪ Off</li> <li>▪ On</li> </ul>	Off
Simulation diagnostic event	–	Switch simulation of the diagnostic event on and off.  For the simulation, you can choose from the diagnostic events of the category selected in the <b>Diagnostic event category</b> parameter.	<ul style="list-style-type: none"> <li>▪ Off</li> <li>▪ Picklist Diagnostic events (depends on the selected category)</li> </ul>	Off

## 10.6 Protecting settings from unauthorized access

The following option exists for protecting the configuration of the measuring device from unintentional modification after commissioning: Write protection via write protection switch

### 10.6.1 Write protection via write protection switch

The write protection switch makes it possible to block write access to the entire operating menu with the exception of the following parameters:

- External pressure
- External temperature
- Reference density
- All parameters for configuring the totalizer

The parameter values are now read only and cannot be edited any more:

- Via service interface (CDI)
- Via Modbus RS485



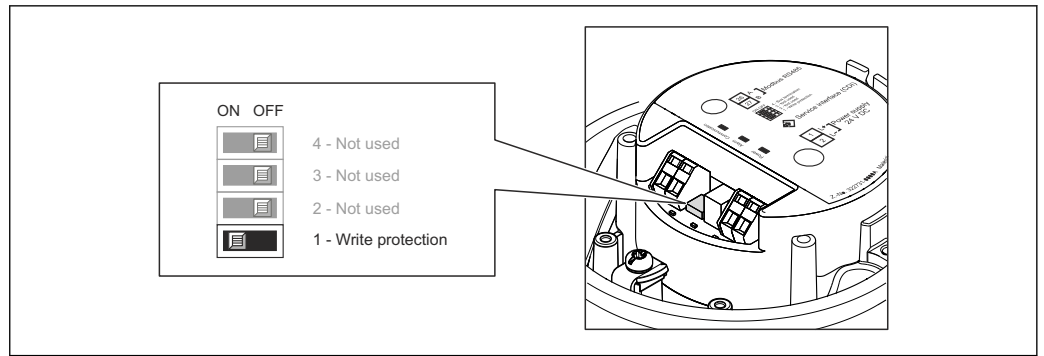

1. Depending on the housing version, loosen the securing clamp or fixing screw of the housing cover.
2. Depending on the housing version, unscrew or open the housing cover.
3. Setting the write protection switch on the main electronics module to the ON position enables the hardware write protection. Setting the write protection switch on the main electronics module to the OFF position (factory setting) disables the hardware write protection.
  - ↳ If hardware write protection is enabled: the **Locking status** parameter displays the **Hardware locked** option (→ 50); if disabled, the **Locking status** parameter does not display any option (→ 50)
4. Reverse the removal procedure to reassemble the transmitter.

# 11 Operation

## 11.1 Reading device locking status

The write protection types that are currently active can be determined using the **Locking status** parameter.

### Navigation

"Operation" menu → Locking status

*Function scope of "Locking status" parameter*

Options	Description
Hardware locked	The locking switch (DIPswitch) for locking the hardware is activated on the main electronic module. This prevents write access to the parameters (→ 48).
Temporarily locked	Due to internal processing in the device (e.g. up-/downloading of data, reset), write access to the parameters is blocked for a short time. Once the internal processing has been completed, the parameters can be changed once again.

## 11.2 Reading measured values

Using the **Measured values** submenu, it is possible to read all the measured values.

"Diagnostics" menu → Measured values

### 11.2.1 Process variables

The **Process variables** submenu contains all the parameters needed to display the current measured values for every process variable.

### Navigation

"Diagnostics" menu → Measured values → Process variables

<b>Process variables</b>	Mass flow
	Volume flow
	Corrected volume flow
	Density
	Reference density
	Temperature
	Pressure value

### Parameter overview with brief description

Parameter	Description	User interface	Factory setting
Mass flow	Displays the volume flow currently measured.	Signed floating-point number	1 kg/h
Volume flow	Displays the mass flow currently calculated.	Signed floating-point number	
Corrected volume flow		Signed floating-point number	1 NI/h
Density	Displays the corrected volume flow currently calculated.	Signed floating-point number	

Parameter	Description	User interface	Factory setting
Reference density	Displays the saturated steam pressure currently calculated.	Signed floating-point number	
Temperature		Signed floating-point number	1 °C
Pressure value	Displays either a fixed or external pressure value.	Signed floating-point number	

### 11.2.2 Totalizer

The "**Totalizer**" submenu contains all the parameters needed to display the current measured values for every totalizer.

#### Navigation

"Diagnostics" menu → Measured values → Totalizer

#### Structure of the submenu

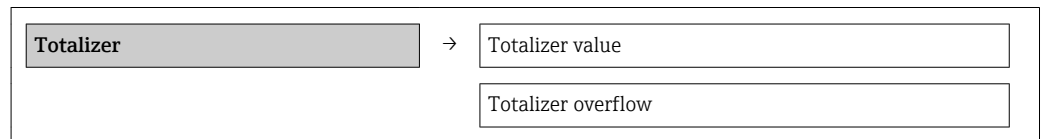

#### Parameter overview with brief description

Parameter	Prerequisite	Description	User interface	Factory setting
Totalizer value	In the <b>Assign process variable</b> parameter of <b>Totalizer 1 to 3</b> submenu one of the following options is selected: <ul style="list-style-type: none"> <li>▪ Volume flow</li> <li>▪ Mass flow</li> <li>▪ Corrected volume flow</li> </ul>	Displays the current totalizer counter value.	Signed floating-point number	0 kg
Totalizer overflow	In the <b>Assign process variable</b> parameter of <b>Totalizer 1 to 3</b> submenu one of the following options is selected: <ul style="list-style-type: none"> <li>▪ Volume flow</li> <li>▪ Mass flow</li> <li>▪ Corrected volume flow</li> </ul>	Displays the current totalizer overflow.	-32.000.0 to 32.000.0	0

## 11.3 Adapting the measuring device to the process conditions

The following are available for this purpose:

- Basic settings using the **Setup** menu(→ 37)
- Advanced settings using the **Advanced setup** submenu(→ 45)

## 11.4 Performing a totalizer reset

In the **Operation** submenu the totalizers are reset:

- Control Totalizer
- Reset all totalizers

*Function scope of "Control Totalizer" parameter*

Options	Description
Totalize	The totalizer is started.
Reset + hold	The totaling process is stopped and the totalizer is reset to 0.
Preset + hold	The totaling process is stopped and the totalizer is set to its defined start value from the <b>Preset value</b> parameter.
Reset + totalize	The totalizer is reset to 0 and the totaling process is restarted.
Preset + totalize	The totalizer is set to the defined start value in <b>Preset value</b> parameter and the totaling process is restarted.

*Function scope of "Reset all totalizers" parameter*

Options	Description
Reset + totalize	Resets all totalizers to 0 and restarts the totaling process. This deletes all the flow values previously totalized.

### Navigation

"Operation" menu → Operation

### Structure of the submenu

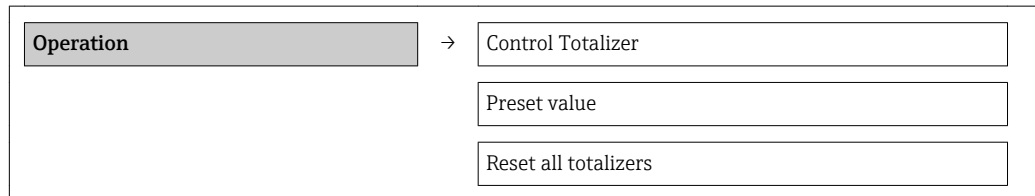



### Parameter overview with brief description

Parameter	Description	Selection / User entry	Factory setting
Control Totalizer	Control totalizer value.	<ul style="list-style-type: none"> <li>■ Totalize</li> <li>■ Reset + hold</li> <li>■ Preset + hold</li> <li>■ Reset + totalize</li> <li>■ Preset + totalize</li> </ul>	Totalize
Preset value	Specify start value for totalizer.	Signed floating-point number	0 kg
Reset all totalizers	Reset all totalizers to 0 and start.	<ul style="list-style-type: none"> <li>■ Cancel</li> <li>■ Reset + totalize</li> </ul>	Cancel





## 12 Diagnostics and troubleshooting

### 12.1 General troubleshooting

*For output signals*

Problem	Possible causes	Remedy
Green power LED on the main electronics module of the transmitter is dark	Supply voltage does not match that specified on the nameplate.	Apply the correct supply voltage (→  24).
Green power LED on the main electronics module of the transmitter is dark	Power supply cable connected incorrectly	Check the terminal assignment .
Green power LED on Safety Barrier Promass 100 is dark	Supply voltage does not match that specified on the nameplate.	Apply the correct supply voltage (→  24).
Green power LED on Safety Barrier Promass 100 is dark	Power supply cable connected incorrectly	Check the terminal assignment (→  23).
Device measures incorrectly.	Configuration error or device is operated outside the application.	1. Check and correct parameter configuration. 2. Observe limit values specified in the "Technical Data".

*For access*

Problem	Possible causes	Remedy
No write access to parameters	Hardware write protection enabled	Set the write protection switch on the main electronics module to the OFF position (→  48).
No connection via Modbus RS485	Modbus RS485 bus cable connected incorrectly	Check the terminal assignment .
No connection via Modbus RS485	Modbus RS485 cable incorrectly terminated	Check terminating resistor (→  26).
No connection via Modbus RS485	Incorrect settings for the communication interface	Check the Modbus RS485 configuration (→  40).
No connection via service interface	Incorrect configuration of USB interface on PC or driver not installed correctly.	Observe the documentation for the Commubox.  FXA291: Document "Technical Information" TI00405C

### 12.2 Diagnostic information via light emitting diodes

#### 12.2.1 Transmitter

Various light emitting diodes (LEDs) on the main electronics module of the transmitter provide information on device status.

LED	Color	Meaning
Power	Off	Supply voltage is off or too low
	Green	Supply voltage is ok
Alarm	Off	Device status is ok
	Flashing red	A device error of diagnostic behavior "Warning" has occurred

LED	Color	Meaning
	Red	<ul style="list-style-type: none"> <li>A device error of diagnostic behavior "Alarm" has occurred</li> <li>Boot loader is active</li> </ul>
Communication	Flashing white	Modbus RS485 communication is active

### 12.2.2 Safety Barrier Promass 100

Various light emitting diodes (LEDs) on the Safety Barrier Promass 100 provide status information.

LED	Color	Color
Power	Off	Supply voltage is off or too low.
	Green	Supply voltage is ok.
Communication	Flashing white	Modbus RS485 communication is active.

## 12.3 Diagnostic information in FieldCare

### 12.3.1 Diagnostic options

Any faults detected by the measuring device are displayed on the home page of the operating tool once the connection has been established.

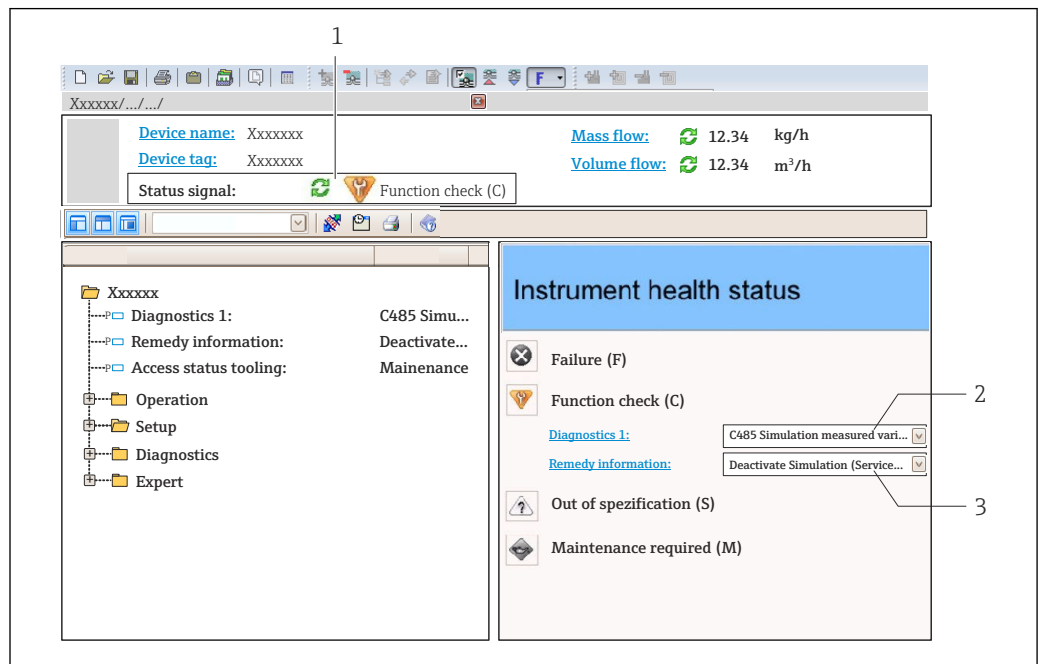





- 1 Status area with status signal
- 2 Diagnostic informatio (→ 55)n
- 3 Remedial measures with Service ID

**i** Furthermore, diagnostic events that have occurred can be viewed in the **Diagnostics** menu:

- Via parameters
- Via submenu (→ 59)

### Status signals

The status signals provide information on the state and reliability of the device by categorizing the cause of the diagnostic information (diagnostic event).

Symbol	Meaning
 A0017271	<b>Failure</b> A device error has occurred. The measured value is no longer valid.
 A0017278	<b>Function check</b> The device is in service mode (e.g. during a simulation).
 A0017277	<b>Out of specification</b> The device is operated: Outside its technical specification limits (e.g. outside the process temperature range)
 A0017276	<b>Maintenance required</b> Maintenance is required. The measured value is still valid.

 The status signals are categorized in accordance with VDI/VDE 2650 and NAMUR Recommendation NE 107.

### Diagnostic information

The fault can be identified using the diagnostic information. The short text helps you by providing information about the fault.

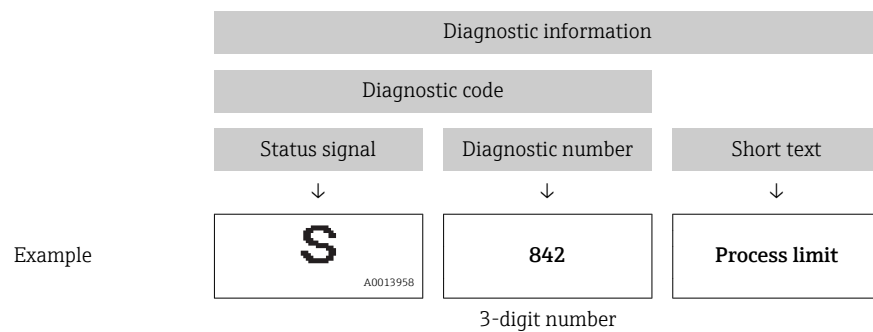

### 12.3.2 Calling up remedy information

Remedy information is provided for every diagnostic event to ensure that problems can be rectified quickly:

- On the home page  
Remedy information is displayed in a separate field below the diagnostics information.
- In the **Diagnostics** menu  
Remedy information can be called up in the working area of the user interface.

The user is in the **Diagnostics** menu.

1. Call up the desired parameter.
2. On the right in the working area, mouse over the parameter.
  - ↳ A tool tip with remedy information for the diagnostic event appears.

## 12.4 Diagnostic information via communication interface

### 12.4.1 Reading out diagnostic information

Diagnostic information can be read out via Modbus RS485 register addresses.

- Via register address **6821** (data type = string): diagnosis code, e.g. F270
- Via register address **6859** (data type = integer): diagnosis number, e.g. 270

 For an overview of diagnostic events with diagnosis number and diagnosis code (→  57)



## 12.4.2 Configuring error response mode

Error response mode for Modbus RS485 communication can be configured in the **Communication** submenu using 2 parameters.

### Navigation path

"Setup" menu → Communication

*Parameter overview with brief description*

Parameter	Description	Options	Factory setting
Assign diagnostic behavior	Select diagnostic behavior for MODBUS communication.	<ul style="list-style-type: none"> <li>▪ Off</li> <li>▪ Alarm or warning</li> <li>▪ Warning</li> <li>▪ Alarm</li> </ul>	Alarm
Failure mode	Select measured value output behavior when a diagnostic message occurs via Modbus communication.   This parameter operates in accordance with the option selected in the <b>Assign diagnostic behavior</b> parameter.	<ul style="list-style-type: none"> <li>▪ NaN value</li> <li>▪ Last valid value</li> </ul>  NaN = not a number	NaN value

## 12.5 Adapting the diagnostic information

### 12.5.1 Adapting the diagnostic behavior

Each item of diagnostic information is assigned a specific diagnostic behavior at the factory. The user can change this assignment for certain diagnostics information in the **Diagnostic behavior** submenu.

"Expert" menu → System → Diagnostic handling → Diagnostic behavior

You can assign the following options to the diagnostic number as the diagnostic behavior:

Options	Description
Alarm	Measurement is interrupted. Measured value output via Modbus RS485 and totalizers assume the defined alarm condition. A diagnostic message is generated.
Warning	Measurement is resumed. Measured value output via Modbus RS485 and totalizers are not affected. A diagnostic message is generated.
Logbook entry only	The device continues to measure. The diagnostic message is entered in the Event logbook (events list) submenu only and is not displayed in alternation with the measured value display.
Off	The diagnostic event is ignored, and no diagnostic message is generated or entered.



## 12.6 Overview of diagnostic information



Diagnostic number	Short text	Repairing action	Status signal from the factory	Diagnostic behaviour from the factory
<b>Diagnostic of sensor</b>				
022	Sensor temperature	1. Change main electronic module 2. Change sensor	F	Alarm
044	Sensor drift	1. Check or change main electronics 2. Change sensor	S	Alarm <sup>1)</sup>
046	Sensor limit	1. Inspect sensor 2. Check process condition	S	Alarm <sup>1)</sup>
062	Sensor connection	1. Change main electronic module 2. Change sensor	F	Alarm
082	Data storage	1. Check module connections 2. Contact service	F	Alarm
083	Memory content	1. Restart device 2. Contact service	F	Alarm
144	Measuring error too high	1. Check or change sensor 2. Check process conditions	F	Alarm <sup>1)</sup>
190	Special event 1	Contact service	F	Alarm
191	Special event 5	Contact service	F	Alarm
192	Special event 9	Contact service	F	Alarm <sup>1)</sup>
<b>Diagnostic of electronic</b>				
242	Software incompatible	1. Check software 2. Flash or change main electronics module	F	Alarm
270	Main electronic failure	Change main electronic module	F	Alarm
271	Main electronic failure	1. Restart device 2. Change main electronic module	F	Alarm
272	Main electronic failure	1. Restart device 2. Contact service	F	Alarm
273	Main electronic failure	Change electronic	F	Alarm
274	Main electronic failure	Change electronic	S	Warning <sup>1)</sup>
311	Electronic failure	1. Reset device 2. Contact service	F	Alarm
390	Special event 2	Contact service	F	Alarm
391	Special event 6	Contact service	F	Alarm
392	Special event 10	Contact service	F	Alarm <sup>1)</sup>
<b>Diagnostic of configuration</b>				
410	Data transfer	1. Check connection 2. Retry data transfer	F	Alarm
411	Up-/download active	Up-/download active, please wait	C	Warning
438	Dataset	1. Check data set file 2. Check device configuration 3. Up- and download new configuration	M	Warning



Diagnostic number	Short text	Repairing action	Status signal from the factory	Diagnostic behaviour from the factory
453	Flow override	Deactivate flow override	C	Warning
484	Simulation failure mode	Deactivate simulation	C	Alarm
485	Simulation measured variable	Deactivate simulation	C	Warning
590	Special event 3	Contact service	M	Alarm
591	Special event 7	Contact service	M	Alarm
592	Special event 11	Contact service	M	Alarm <sup>1)</sup>
<b>Diagnostic of process</b>				
830	Ambient temperature	Reduce ambient temp. around the sensor housing	S	Warning
831	Ambient temperature	Increase ambient temp. around the sensor housing	S	Warning
832	Ambient temperature	Reduce ambient temperature	S	Warning <sup>1)</sup>
833	Ambient temperature	Increase ambient temperature	S	Warning <sup>1)</sup>
834	Process temperature	Reduce process temperature	S	Warning <sup>1)</sup>
835	Process temperature	Increase process temperature	S	Warning <sup>1)</sup>
843	Process limit	Check process conditions	S	Warning
862	Partly filled pipe	1. Check for gas in process 2. Adjust detection limits	S	Warning
910	Tubes not oscillating	1. Check electronic 2. Inspect sensor	F	Alarm
912	Inhomogeneous	1. Check process cond. 2. Increase system pressure	S	Warning <sup>1)</sup>
913	Inhomogeneous	1. Check process conditions 2. Check electronic modules or sensor	S	Alarm <sup>1)</sup>
944	Monitoring failed	Check process conditions for Heartbeat Monitoring	S	Warning <sup>1)</sup>
990	Special event 4	Contact service	F	Alarm
991	Special event 8	Contact service	F	Alarm
992	Special event 12	Contact service	F	Alarm <sup>1)</sup>

1) Diagnostic status is changeable.

## 12.7 Pending diagnostic events

The **Diagnostics** menu allows the user to view the current diagnostic event and the previous diagnostic event separately.

 To call up the measures to rectify a diagnostic event:  
Via "FieldCare" operating tool (→  55)

 Other pending diagnostic events can be displayed in the **Diagnostic list** submenu (→  59)

### Navigation

"Diagnostics" menu

**Structure of the submenu**

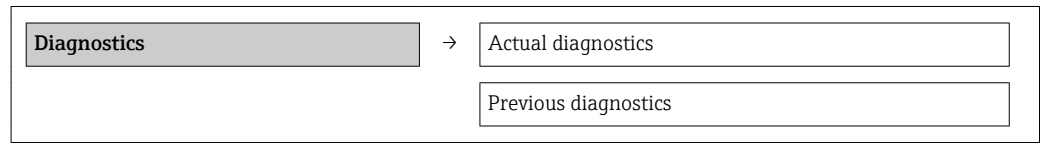

**Parameter overview with brief description**



Parameter	Prerequisite	Description	User interface	Factory setting
Actual diagnostics	1 diagnostic event has occurred.	Displays the current diagnostic event along with the diagnostic information.  If two or more messages occur simultaneously, the message with the highest priority is shown on the display.	Symbol for diagnostic behavior, diagnostic code and short message.	-
Previous diagnostics	2 diagnostic events have already occurred.	Displays the diagnostic event that occurred prior to the current diagnostic event along with the diagnostic information.	Symbol for diagnostic behavior, diagnostic code and short message.	-

**12.8 Diagnostic list**

In the **Diagnostic list** submenu, up to 5 currently pending diagnostic events can be displayed along with the related diagnostic information. If more than 5 diagnostic events are pending, the events with the highest priority are shown on the display.

**Navigation path**

**Diagnostics** menu → **Diagnostic list** submenu

 To call up the measures to rectify a diagnostic event:  
Via "FieldCare" operating tool (→  55)

**12.9 Event logbook**

**12.9.1 Event history**



A chronological overview of the event messages that have occurred is provided in the events list which contains a maximum of 20 message entries. This list can be displayed via FieldCare if necessary.

**Navigation path**



Event list: **F** → Tool box → Additional functions



 For information on the event list, see the FieldCare user interface

This event history includes entries for:

- Diagnostic events (→  57)
- Information events (→  60)

In addition to the operation time of its occurrence and possible troubleshooting measures, each event is also assigned a symbol that indicates whether the event has occurred or is ended:

- Diagnostic event
  - : Event has occurred
  - : Event has ended
- Information event
  - : Event has occurred

 To call up the measures to rectify a diagnostic event:  
Via "FieldCare" operating tool (→  55)

 For filtering the displayed event messages (→  60)

## 12.9.2 Filtering the event logbook

Using the **Filter options** parameter, you can define which category of event messages is displayed in the **Events list** submenu.

### Navigation path

"Diagnostics" menu → Event logbook → Filter options

### Filter categories

- All
- Failure (F)
- Function check (C)
- Out of specification (S)
- Maintenance required (M)
- Information (I)

## 12.9.3 Overview of information events

Unlike a diagnostic event, an information event is displayed in the event logbook only and not in the diagnostic list.

Info number	Info name
I1000	----- (Device ok)
I1089	Power on
I1090	Configuration reset
I1091	Configuration changed
I1110	Write protection switch changed
I1111	Density adjust failure
I1151	History reset
I1209	Density adjustment ok
I1221	Zero point adjust failure
I1222	Zero point adjustment ok
I1444	Device verification passed
I1445	Device verification failed
I1446	Device verification active
I1447	Record application reference data
I1448	Application reference data recorded
I1449	Recording application ref. data failed
I1450	Monitoring off
I1451	Monitoring on

Info number	Info name
I1457	Failed:Measured error verification
I1459	Failed: I/O module verification
I1460	Failed: Sensor integrity verification
I1461	Failed: Sensor verification
I1462	Failed:Sensor electronic module verific.

## 12.10 Resetting the measuring device

Using the **Device reset** parameter it is possible to reset the entire device configuration or some of the configuration to a defined state.

"Setup" menu → Advanced setup → Administration

*Function scope of "Device reset" parameter*

Options	Description
Cancel	No action is executed and the user exits the parameter.
To delivery settings	Every parameter for which a customer-specific default setting was ordered is reset to this customer-specific value. All other parameters are reset to the factory setting.  This option is not visible if no customer-specific settings have been ordered.
Restart device	The restart resets every parameter whose data are in the volatile memory (RAM) to the factory setting (e.g. measured value data). The device configuration remains unchanged.
History reset	Every parameter is reset to its factory setting.

## 12.11 Device information

The **Device information** submenu contains all the parameters that display different information for identifying the device.

### Navigation

"Diagnostics" menu → Device information

<b>Device information</b>	→	Device tag
		Serial number
		Firmware version
		Device name
		Order code
		Extended order code 1
		Extended order code 2
		Extended order code 3
		ENP version

### Parameter overview with brief description

Parameter	Description	User interface	Factory setting
Device tag	Enter tag for measuring point.	Max. 32 characters, such as letters, numbers or special characters (e.g. @, %, /)	Promass 100
Serial number	Displays the serial number of the measuring device.	Max. 11-digit character string comprising letters and numbers.	79AFF16000
Firmware version	Displays the device firmware version installed.	Character string with the following format: xx.yy.zz	01.02
Device name	Displays the name of the transmitter.	Character string composed of letters, numbers and certain punctuation marks.	Promass 100
Order code	Displays the device order code.	Character string composed of letters, numbers and certain punctuation marks	-
Extended order code 1	Displays the 1st part of the extended order code.	Character string	-
Extended order code 2	Displays the 2nd part of the extended order code.	Character string	-
Extended order code 3	Displays the 3rd part of the extended order code.	Character string	-
ENP version	Displays the version of the electronic nameplate.	Character string in the format xx.yy.zz	2.02.00

## 12.12 Firmware history

Release date	Firmware version	Order code for "Firmware version"	Firmware changes	Documentation type	Documentation
04.2013	01.02.00	Option 74	Original firmware	Operating Instructions	BA01283D/06/EN/01.14

 Flashing the firmware to the current version or to the previous version is possible via the service interface (CDI) .

 For the compatibility of the firmware version with the previous version, the installed device description files and operating tools, observe the information about the device in the "Manufacturer's information" document.

 The manufacturer's information is available:

- In the Download Area of the Endress+Hauser Internet site: [www.endress.com](http://www.endress.com) → Download
- Specify the following details:
  - Product root, e.g. 8E1B
  - Text search: Manufacturer's information
  - Search range: documentation

## 13 Maintenance

### 13.1 Maintenance tasks

No special maintenance work is required.

#### 13.1.1 Exterior cleaning

When cleaning the exterior of measuring devices, always use cleaning agents that do not attack the surface of the housing or the seals.

#### 13.1.2 Interior cleaning

Observe the following points for CIP and SIP cleaning:

- Use only cleaning agents to which the process-wetted materials are adequately resistant.
- Observe the maximum permitted medium temperature for the measuring device (→  71).

### 13.2 Measuring and test equipment

Endress+Hauser offers a wide variety of measuring and test equipment, such as W@M or device tests.

 Your Endress+Hauser Sales Center can provide detailed information on the services.

 For a list of some of the measuring and test equipment, refer to the "Accessories" chapter of the "Technical Information" document for the device.

### 13.3 Endress+Hauser services

Endress+Hauser offers a wide variety of services for maintenance such as recalibration, maintenance service or device tests.

 Your Endress+Hauser Sales Center can provide detailed information on the services.

## 14 Repair

### 14.1 General notes

#### Repair and conversion concept

The Endress+Hauser repair and conversion concept provides for the following:

- The measuring devices have a modular design.
- Spare parts are grouped into logical kits with the associated Installation Instructions.
- Repairs are carried out by Endress+Hauser Service or by correspondingly trained customers.
- Certified devices can be converted into other certified devices by Endress+Hauser Service or at the factory only.

#### Notes for repair and conversion

For repair and modification of a measuring device, observe the following notes:

- Use only original Endress+Hauser spare parts.
- Carry out the repair according to the Installation Instructions.
- Observe the applicable standards, federal/national regulations, Ex documentation (XA) and certificates.
- Document every repair and each conversion and enter them into the *W@M* life cycle management database.

### 14.2 Spare parts

 Measuring device serial number:

- Is located on the nameplate of the device.
- Can be read out via the **Serial number** parameter in the **Device information** submenu (→  61).

### 14.3 Endress+Hauser services

 Contact your Endress+Hauser Sales Center for information on services and spare parts.

### 14.4 Return

The measuring device must be returned if repairs or a factory calibration are required, or if the wrong measuring device has been ordered or delivered. According to legal regulations, Endress+Hauser, as an ISO-certified company, is required to follow certain procedures when handling returned products that are in contact with medium.

To ensure swift, safe and professional device returns, please read the return procedures and conditions on the Endress+Hauser website at

[www.services.endress.com/return-material](http://www.services.endress.com/return-material)

### 14.5 Disposal

#### 14.5.1 Removing the measuring device

1. Switch off the device.
2. **WARNING!** Danger to persons from process conditions. Beware of hazardous process conditions such as pressure in the measuring device, high temperatures or aggressive fluids.



Carry out the mounting and connection steps from the chapters "Mounting the measuring device" and "Connecting the measuring device" in the logically reverse sequence. Observe the safety instructions.

### 14.5.2 Disposing of the measuring device

**⚠ WARNING**

**Danger to personnel and environment from fluids that are hazardous to health.**

- ▶ Ensure that the measuring device and all cavities are free of fluid residues that are hazardous to health or the environment, e.g. substances that have permeated into crevices or diffused through plastic.

Observe the following notes during disposal:

- Observe valid federal/national regulations.
- Ensure proper separation and reuse of the device components.

## 15 Accessories

Various accessories, which can be ordered with the device or subsequently from Endress+Hauser, are available for the device. Detailed information on the order code in question is available from your local Endress+Hauser sales center or on the product page of the Endress+Hauser website: [www.endress.com](http://www.endress.com).

### 15.1 Communication-specific accessories

Accessories	Description
Commubox FXA291	<p>Connects Endress+Hauser field devices with a CDI interface (= Endress+Hauser Common Data Interface) and the USB port of a computer or laptop.</p> <p> For details, see "Technical Information" TI00405C</p>

### 15.2 Service-specific accessories

Accessories	Description
Applicator	<p>Software for selecting and sizing Endress+Hauser measuring devices:</p> <ul style="list-style-type: none"> <li>▪ Calculation of all the necessary data for identifying the optimum flowmeter: e.g. nominal diameter, pressure loss, accuracy or process connections.</li> <li>▪ Graphic illustration of the calculation results</li> </ul> <p>Administration, documentation and access to all project-related data and parameters over the entire life cycle of a project.</p> <p>Applicator is available:</p> <ul style="list-style-type: none"> <li>▪ Via the Internet: <a href="https://wapps.endress.com/applicator">https://wapps.endress.com/applicator</a></li> <li>▪ On CD-ROM for local PC installation.</li> </ul>
W@M	<p>Life cycle management for your plant</p> <p>W@M supports you with a wide range of software applications over the entire process: from planning and procurement, to the installation, commissioning and operation of the measuring devices. All the relevant device information, such as the device status, spare parts and device-specific documentation, is available for every device over the entire life cycle.</p> <p>The application already contains the data of your Endress+Hauser device. Endress+Hauser also takes care of maintaining and updating the data records.</p> <p>W@M is available:</p> <ul style="list-style-type: none"> <li>▪ Via the Internet: <a href="http://www.endress.com/lifecyclemanagement">www.endress.com/lifecyclemanagement</a></li> <li>▪ On CD-ROM for local PC installation.</li> </ul>
FieldCare	<p>FDT-based plant asset management tool from Endress+Hauser.</p> <p>It can configure all smart field units in your system and helps you manage them. By using the status information, it is also a simple but effective way of checking their status and condition.</p> <p> For details, see Operating Instructions BA00027S and BA00059S</p>

## 16 Technical data

### 16.1 Application

The measuring device is suitable for flow measurement of liquids and gases only.

Depending on the version ordered, the measuring device can also measure potentially explosive, flammable, poisonous and oxidizing media.

To ensure that the device remains in proper operating condition for its service life, use the measuring device only for media against which the process-wetted materials are adequately resistant.

### 16.2 Function and system design

Measuring principle	Mass flow measurement based on the Coriolis measuring principle
Measuring system	<p>The device consists of a transmitter and a sensor. If a device with Modbus RS485 intrinsically safe is ordered, the Safety Barrier Promass 100 is part of the scope of supply and must be implemented to operate the device.</p> <p>One device version is available: compact version, transmitter and sensor form a mechanical unit.</p> <p>For information on the structure of the device (→  11)</p>

### 16.3 Input

Measured variable	<p><b>Direct measured variables</b></p> <ul style="list-style-type: none"> <li>▪ Mass flow</li> <li>▪ Density</li> <li>▪ Temperature</li> </ul>
-------------------	---

Measuring range	<b>Measuring ranges for Compressed Natural Gas (CNG), non-custody transfer operation</b>
-----------------	--

DN		Measuring range full scale values $\dot{m}_{\min(F)}$ to $\dot{m}_{\max(F)}$	
[mm]	[in]	[kg/min]	[lb/min]
8	$\frac{3}{8}$	0 to 30	0 to 66
15	$\frac{1}{2}$	0 to 80	0 to 175
25	1	0 to 150	0 to 330

 The values of the corresponding custody transfer certificate apply in custody transfer mode.

#### Recommended measuring range

"Flow limit" section (→  72)

Operable flow range	Over 1000 : 1.
---------------------	----------------

Flow rates above the preset full scale value are not overridden by the electronics unit, with the result that the totalizer values are registered correctly.

## 16.4 Output

Output signal

### Modbus RS485

Physical interface	In accordance with EIA/TIA-485-A standard
Terminating resistor	Integrated, can be activated via DIP switch on the transmitter electronics module

Signal on alarm

Depending on the interface, failure information is displayed as follows:

### Modbus RS485

Failure mode	Choose from: <ul style="list-style-type: none"> <li>▪ NaN value instead of current value</li> <li>▪ Last valid value</li> </ul>
--------------	---

### Operating tool

Via service interface

Plain text display	With information on cause and remedial measures
--------------------	---

### Light emitting diodes (LED)

Status information	Status indicated by various light emitting diodes The following information is displayed depending on the device version: <ul style="list-style-type: none"> <li>▪ Supply voltage active</li> <li>▪ Data transmission active</li> <li>▪ Device alarm/error has occurred</li> </ul>
--------------------	---

Low flow cut off

The switch points for low flow cut off are user-selectable.

Galvanic isolation



The following connections are galvanically isolated from each other:

- Outputs
- Power supply

Protocol-specific data

### Modbus RS485

Protocol	Modbus Applications Protocol Specification V1.1
Device type	Slave
Slave address range	1 to 247
Broadcast address range	0
Function codes	<ul style="list-style-type: none"> <li>▪ 03: Read holding register</li> <li>▪ 04: Read input register</li> <li>▪ 06: Write single registers</li> <li>▪ 08: Diagnostics</li> <li>▪ 16: Write multiple registers</li> <li>▪ 23: Read/write multiple registers</li> </ul>

Broadcast messages	Supported by the following function codes: <ul style="list-style-type: none"> <li>▪ 06: Write single registers</li> <li>▪ 16: Write multiple registers</li> <li>▪ 23: Read/write multiple registers</li> </ul>
Supported baud rate	<ul style="list-style-type: none"> <li>▪ 1 200 BAUD</li> <li>▪ 2 400 BAUD</li> <li>▪ 4 800 BAUD</li> <li>▪ 9 600 BAUD</li> <li>▪ 19 200 BAUD</li> <li>▪ 38 400 BAUD</li> <li>▪ 57 600 BAUD</li> <li>▪ 115 200 BAUD</li> </ul>
Data transfer mode	<ul style="list-style-type: none"> <li>▪ ASCII</li> <li>▪ RTU</li> </ul>
Data access	Each device parameter can be accessed via Modbus RS485.  For Modbus register information (→  76)

## 16.5 Power supply

Terminal assignment (→  22)

Supply voltage

### Transmitter

- For device version with all communication types except Modbus RS485 intrinsically safe: DC 20 to 30 V
- For device version with Modbus RS485 intrinsically safe: power supply via Safety Barrier Promass 100

The power unit must be tested to ensure it meets safety requirements (e.g. PELV, SELV).

### Safety Barrier Promass 100

DC 20 to 30 V

Power consumption

### Transmitter

Order code for "Output"	Maximum Power consumption
Option <b>M</b> : Modbus RS485, for use in intrinsically safe areas	2.45 W

### Safety Barrier Promass 100

Order code for "Output"	Maximum Power consumption
Option <b>M</b> : Modbus RS485, for use in intrinsically safe areas	4.8 W

Current consumption

### Transmitter

Order code for "Output"	Maximum Current consumption	Maximum switch-on current
Option <b>M</b> : Modbus RS485, for use in intrinsically safe areas	145 mA	16 A (<0.4 ms)

**Safety Barrier Promass 100**

Order code for "Output"	Maximum Current consumption	Maximum switch-on current
Option <b>M</b> : Modbus RS485, for use in intrinsically safe areas	230 mA	10 A (<0.8 ms)

Power supply failure

- Totalizers stop at the last value measured.
- Configuration is retained in the device memory.
- Error messages (incl. total operated hours) are stored.

Electrical connection (→  24)

Potential equalization No special measures for potential equalization are required.

Terminals

**Transmitter**  
Spring terminals for wire cross-sections 0.5 to 2.5 mm<sup>2</sup> (20 to 14 AWG)

**Safety Barrier Promass 100**  
Plug-in screw terminals for wire cross-sections 0.5 to 2.5 mm<sup>2</sup> (20 to 14 AWG)

Cable entries



- Cable gland: M20 × 1.5 with cable  $\phi$ 6 to 12 mm (0.24 to 0.47 in)
- Thread for cable entry:
  - NPT 1/2"
  - G 1/2"
  - M20

Cable specification (→  20)

**16.6 Performance characteristics**

Reference operating conditions

- Error limits based on ISO 11631
- Water with +15 to +45 °C (+59 to +113 °F) at 2 to 6 bar (29 to 87 psi)
- Specifications as per calibration protocol
- Accuracy based on accredited calibration rigs that are traced to ISO 17025.

 To obtain measured errors, use the *Applicator* sizing tool (→  75)

Maximum measured error

**Base accuracy**

**Mass flow (gases)**  
±0.50 % of the quantity filled in typical CNG refueling with the coefficients determined during factory calibration.

**Temperature**  
±0.5 °C ± 0.005 · T °C (±0.9 °F ± 0.003 · (T - 32) °F)

Repeatability

**Base repeatability**

**Mass flow (gases)**  
±0.25 % of the quantity filled in typical CNG refueling

**Temperature**  
±0.25 °C ± 0.0025 · T °C (±0.45 °F ± 0.0015 · (T - 32) °F)

---

Response time	<ul style="list-style-type: none"> <li>■ The response time depends on the configuration (damping).</li> <li>■ Response time in the event of erratic changes in the measured variable (only mass flow): after 100 ms → 95 % of the full scale value</li> </ul>
---------------	---

---

Influence of medium temperature	<p><b>Mass flow</b></p> <p>When there is a difference between the temperature for zero point adjustment and the process temperature, the typical measured error of the sensor is <math>\pm 0.0003</math> % of the full scale value/<math>^{\circ}\text{C}</math> (<math>\pm 0.00015</math> % of the full scale value/<math>^{\circ}\text{F}</math>).</p> <p><b>Temperature</b></p> <p><math>\pm 0.005 \cdot T</math> <math>^{\circ}\text{C}</math> (<math>\pm 0.005 \cdot (T - 32)</math> <math>^{\circ}\text{F}</math>)</p>
---------------------------------	--

---

Influence of medium pressure	A difference between the calibration pressure and process pressure does not affect accuracy.
------------------------------	--

---

## 16.7 Installation

"Mounting requirements" (→  17)

## 16.8 Environment

---

Ambient temperature range	(→  17)
---------------------------	--

---

Storage temperature	$-40$ to $+60$ $^{\circ}\text{C}$ ( $-40$ to $+140$ $^{\circ}\text{F}$ )
---------------------	--

---

Climate class	DIN EN 60068-2-38 (test Z/AD)
---------------	-------------------------------

---

Degree of protection	<p><b>Transmitter and sensor</b></p> <ul style="list-style-type: none"> <li>■ As standard: IP66/67, type 4X enclosure</li> <li>■ When housing is open: IP20, type 1 enclosure</li> </ul> <p><b>Safety Barrier Promass 100</b></p> <p>IP20</p>
----------------------	---

---

Shock resistance	As per IEC/EN 60068-2-31
------------------	--------------------------

---

Vibration resistance	Acceleration up to 1 g, 10 to 150 Hz, based on IEC/EN 60068-2-6
----------------------	---

---

Electromagnetic compatibility (EMC)	<ul style="list-style-type: none"> <li>■ As per IEC/EN 61326 and NAMUR Recommendation 21 (NE 21)</li> <li>■ Complies with emission limits for industry as per EN 55011 (Class A)</li> </ul> <p> Details are provided in the Declaration of Conformity.</p>
-------------------------------------	---







---

## 16.9 Process

---

Medium temperature range	<p><b>Sensor</b></p> <p><math>-50</math> to <math>+125</math> <math>^{\circ}\text{C}</math> (<math>-58</math> to <math>+257</math> <math>^{\circ}\text{F}</math>)</p>
--------------------------	---

**Seals**  
No internal seals

Medium pressure range (nominal pressure)	Measuring tubes, connector: max. 350 bar (5 080 psi)
Medium density	0 to 5 000 kg/m <sup>3</sup> (0 to 312 lb/cf)
Pressure-temperature ratings	 An overview of the material load diagrams (pressure/temperature curves) for the process connections is provided in the "Technical Information" document for the device on the CD-ROM provided.
Rupture disk	Triggering pressure in the housing: 10 to 15 bar (145 to 218 psi) Special mounting instructions: (→  17)
Flow limit	Select the nominal diameter by optimizing between the required flow range and permissible pressure loss.  For an overview of the measuring range full scale values, see the "Measuring range" section (→  67) <ul style="list-style-type: none"><li>■ The minimum recommended full scale value is approx. 1/20 of the maximum full scale value</li><li>■ In most applications, 20 to 50 % of the maximum full scale value can be considered ideal</li><li>■ Select a lower full scale value for abrasive substances (such as liquids with entrained solids): flow velocity &lt;1 m/s (&lt;3 ft/s).</li></ul>
Pressure loss	 To calculate the pressure loss, use the <i>Applicator</i> sizing tool (→  75)



## 16.10 Mechanical construction

Design, dimensions



For the dimensions and installation lengths of the device, see the "Technical Information" document, "Mechanical construction" section

Weight

### Compact version

*Weight in SI units*

DN [mm]	Weight [kg]
8	3.8
15	4.4
25	5.1

*Weight in US units*

DN [in]	Weight [lbs]
3/8	8.4
1/2	9.7
1	11.3

### Safety Barrier Promass 100

49 g (1.73 ounce)

Materials

### Transmitter housing

Order code for "Housing", option A "Compact, aluminum coated":  
Coated aluminum AlSi10Mg

### Cable entries/cable glands

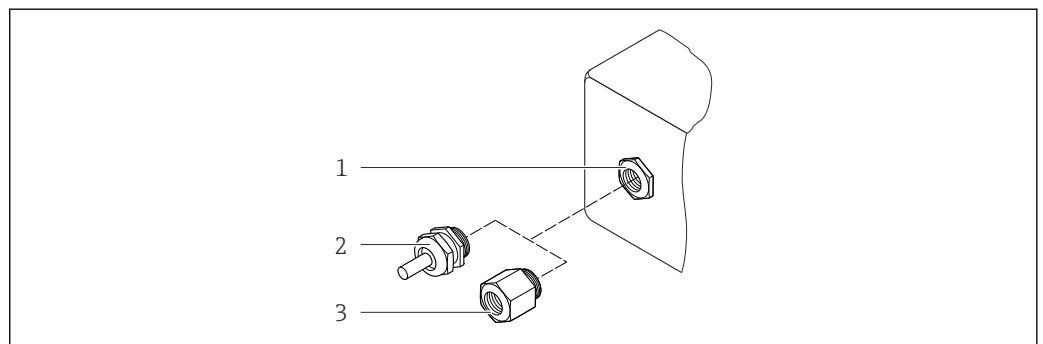

12 Possible cable entries/cable glands

- 1 Cable entry in transmitter housing, wall-mount housing or connection housing with internal thread M20 x 1.5
- 2 Cable gland M20 x 1.5
- 3 Adapter for cable entry with internal thread G 1/2" or NPT 1/2"

Order code for "Housing", option A "Compact, coated aluminum"

The various cable entries are suitable for hazardous and non-hazardous areas.

Cable entry/cable gland	Material
Cable gland M20 × 1.5	Nickel-plated brass
Adapter for cable entry with internal thread G ½"	
Adapter for cable entry with internal thread NPT ½"	

### Sensor housing

- Acid and alkali-resistant outer surface
- Stainless steel 1.4301 (304)

### Measuring tubes

- Stainless steel 1.4435 (316L); manifold: 1.4404 (316/316L)
- Surface quality:
  - Not polished
  - Ra<sub>max</sub> = 0.8 µm (32 µin)

### Process connections

For all process connections:  
Stainless steel 1.4404 (316/316L)

 List of all available process connections (→  74)

### Seals

Welded process connections without internal seals

### Safety Barrier Promass 100



Housing: Polyamide

## Process connections

Cylindrical internal thread BSPP (G) in accordance with ISO 228-1 with sealing surfaces in accordance with DIN 3852-2/ISO 1179-1:

- G ½" for DN 08
- G ¾" for DN 15
- G 1" for DN 25

 Sealed with profile seal in accordance with DIN 3869 or copper disk or steel seal disk with plastic lip.

 For information on the materials of the process connections (→  74)

## 16.11 Operability

### Remote operation

#### Service interface (CDI)

Operation of the measuring device with the service interface (CDI) via:  
"FieldCare" operating tool with COM DTM "CDI Communication FXA291" via Commubox FXA291

---

Languages	Can be operated in the following languages: Via "FieldCare" operating tool: English, German
-----------	---

## 16.12 Certificates and approvals

---

CE mark	The measuring system is in conformity with the statutory requirements of the applicable EC Directives. These are listed in the corresponding EC Declaration of Conformity along with the standards applied.  Endress+Hauser confirms successful testing of the device by affixing to it the CE mark.
---------	--

---

C-Tick symbol	The measuring system meets the EMC requirements of the "Australian Communications and Media Authority (ACMA)".
---------------	--

---

Ex approval	The devices are certified for use in hazardous areas and the relevant safety instructions are provided in the separate "Safety Instructions" (XA) document. Reference is made to this document on the nameplate.
-------------	--

---



Modbus RS485 certification	The measuring device meets all the requirements of the MODBUS/TCP conformity test and has the "MODBUS/TCP Conformance Test Policy, Version 2.0". The measuring device has successfully passed all the test procedures carried out and is certified by the "MODBUS/TCP Conformance Test Laboratory" of the University of Michigan.
----------------------------	---

## 16.13 Application packages

Many different application packages are available to enhance the functionality of the device. Such packages might be needed to address safety aspects or specific application requirements.

The application packages can be ordered from Endress+Hauser either directly with the device or subsequently. Detailed information on the order code in question is available from your local Endress+Hauser sales center or on the product page of the Endress+Hauser website: [www.endress.com](http://www.endress.com).

## 16.14 Accessories

 Overview of accessories available for order (→  66)



## 16.15 Documentation

-  For an overview of the scope of the associated Technical Documentation, refer to the following:
- The CD-ROM provided for the device (depending on the device version, the CD-ROM might not be part of the delivery!)
  - The *W@M Device Viewer* : Enter the serial number from the nameplate ([www.endress.com/deviceviewer](http://www.endress.com/deviceviewer))
  - The *Endress+Hauser Operations App*: Enter the serial number from the nameplate or scan the 2-D matrix code (QR code) on the nameplate.

Standard documentation

Communication	Document type	Documentation code
-	Brief Operating Instructions	KA01170D
-	Technical Information	TI01142D

Supplementary device-dependent documentation

Document type	Contents	Documentation code
Safety Instructions	ATEX/IECEX Ex i	XA01251D
	cCSAus IS	XA01252D
	INMETRO	XA01253D
	NEPSI	XA01254D
Special Documentation	Modbus RS485 Register Information	SD01166D
Installation Instructions		Specified for each individual accessory (→  66)  Overview of accessories available for order (→  66)

# 17 Appendix

## 17.1 Overview of the operating menu

The following table provides an overview of the entire operating menu structure with menus and parameters. The page reference indicates where a description of the parameter can be found in the manual.

<b>Display/operat.</b> →		(→ 30)
Locking status		(→ 50)
	<b>Operation</b> →	(→ 52)
	Control totalizer 1 to 3	
	Preset value 1 to 3	(→ 52)
	Reset all totalizers	
<b>Setup</b> →		(→ 37)
	<b>System units</b> →	(→ 37)
	Mass flow unit	
	Mass unit	
	Volume flow unit	
	Volume unit	
	Corrected volume flow unit	
	Corrected volume unit	
	Density unit	
	Reference density unit	
	Temperature unit	
	Pressure unit	
	<b>Medium selection</b> →	(→ 40)
	Select medium	
	Select gas type	
	Reference sound velocity	
	Temperature coefficient sound velocity	
	Pressure compensation	
	Pressure value	
	External pressure	

<b>Communication</b>	→	(→ 40)
Bus address		
Baud rate		
Data transfer mode		
Parity		
Byte order		
Assign diagnostic behavior		
Failure mode		
<b>Low flow cut off</b>	→	(→ 43)
Assign process variable		
On value low flow cutoff		
Off value low flow cutoff		
Pressure shock suppression		
<b>Partially filled pipe detection</b>	→	(→ 44)
Assign process variable		
Low value partial filled pipe detection		
High value partial filled pipe detection		
Response time part. filled pipe detect.		
<b>Advanced setup</b>	→	(→ 45)
Enter access code		
Device tag		(→ 37)
<b>Calculated values</b>	→	(→ 45)
Corrected volume flow calculation		
External reference density		
Fixed reference density		
Reference temperature		
Linear expansion coefficient		



	Assign behavior of diagnostic no. 832	
	Assign behavior of diagnostic no. 833	
	Assign behavior of diagnostic no. 834	
	Assign behavior of diagnostic no. 835	
	Assign behavior of diagnostic no. 912	
	Assign behavior of diagnostic no. 913	
	Assign behavior of diagnostic no. 944	
	Assign behavior of diagnostic no. 992	
	<b>Management</b>	→
	Device reset	
	Activate SW option	
	SW option overview	
	Permanent storage	
	Device tag	
<b>Sensor</b>		→ (→ 50)
	<b>Measured values</b>	→ (→ 50)
	<b>Process variables</b>	→ (→ 50)
	Mass flow	
	Volume flow	
	Corrected volume flow	
	Density	
	Reference density	
	Temperature	
	Pressure value	
	<b>Totalizer</b>	→ (→ 51)
	Totalizer value1 to 3	
	Totalizer overflow1 to 3	
	<b>System units</b>	→ (→ 37)



Mass flow unit	
Mass unit	
Volume flow unit	
Volume unit	
Corrected volume flow unit	
Corrected volume unit	
Density unit	
Reference density unit	
Temperature unit	
Pressure unit	
Date/time format	
	<b>User-specific units</b> →
	User mass text
	User mass factor
	User volume text
	User volume factor
	User corrected volume text
	User corrected volume factor
	User density text
	User density offset
	User density factor
	User pressure text
	User pressure offset
	User pressure factor
	<b>Process param.</b> →
	Flow damping
	Density damping
	Flow override
	Temperature damping
	<b>Low flow cut off</b> → (→ 43)

	Assign process variable	
	On value low flow cutoff	
	Off value low flow cutoff	
	Pressure shock suppression	
	<b>Partially filled pipe detection</b>	→ (→ ⓘ 44)
	Assign process variable	
	Low value partial filled pipe detection	
	High value partial filled pipe detection	
	Response time part. filled pipe detect.	
	Maximum damping partial filled pipe det.	
	<b>Measuring mode</b>	→ (→ ⓘ 40)
	Select medium	
	Select gas type	
	Reference sound velocity	
	Temperature coefficient sound velocity	
	<b>External compensation</b>	→
	Pressure compensation	
	Pressure value	
	External pressure	
	Temperature mode	
	External temperature	
	<b>Calculated values</b>	→ (→ ⓘ 45)
	Corrected volume flow calculation	
	External reference density	
	Fixed reference density	
	Reference temperature	
	Linear expansion coefficient	

Square expansion coefficient		
<b>Sensor adjustment</b>	→	(→ 46)
Installation direction		
		<b>Zero point adjustment</b> →
		Zero point adjustment control
		Progress
		<b>Variable adjust</b> →
		Mass flow offset
		Mass flow factor
		Volume flow offset
		Volume flow factor
		Corrected volume flow offset
		Corrected volume flow factor
		Density offset
		Density factor
		Reference density offset
		Reference density factor
		Temperature offset
		Temperature factor
		<b>Calibration</b> →
		Calibration factor
		Zero point
		Nominal diameter
		C0 to 5
		<b>Testpoints</b> →
		Oscillation frequency 0 to 1
		Frequency fluctuation 0 to 1
		Oscillation amplitude 0 to 1

	Oscillation damping0 to 1	
	Tube damping fluctuation0 to 1	
	Signal asymmetry	
	Electronic temperature	
	Carrier pipe temperature	
	Exciter current 0 to 1	
<b>Communication</b>	→	(→ 40)
	<b>Modbus configuration</b>	→
	Bus address	
	Baud rate	
	Data transfer mode	
	Parity	
	Byte order	
	Telegram delay	
	Assign diagnostic behavior	
	Failure mode	
	Interpreter mode	
		<b>Modbus data map</b> → (→ 34)
		Scan list register0 to 15
		<b>Measured values</b> → (→ 50)
		<b>Process variables</b> → (→ 50)
		Mass flow
		Volume flow
		Density
		Temperature
		Pressure value
		<b>Totalizer</b> → (→ 51)
		Totalizer value1 to 2
		<b>System units</b> → (→ 37)
		Mass flow unit

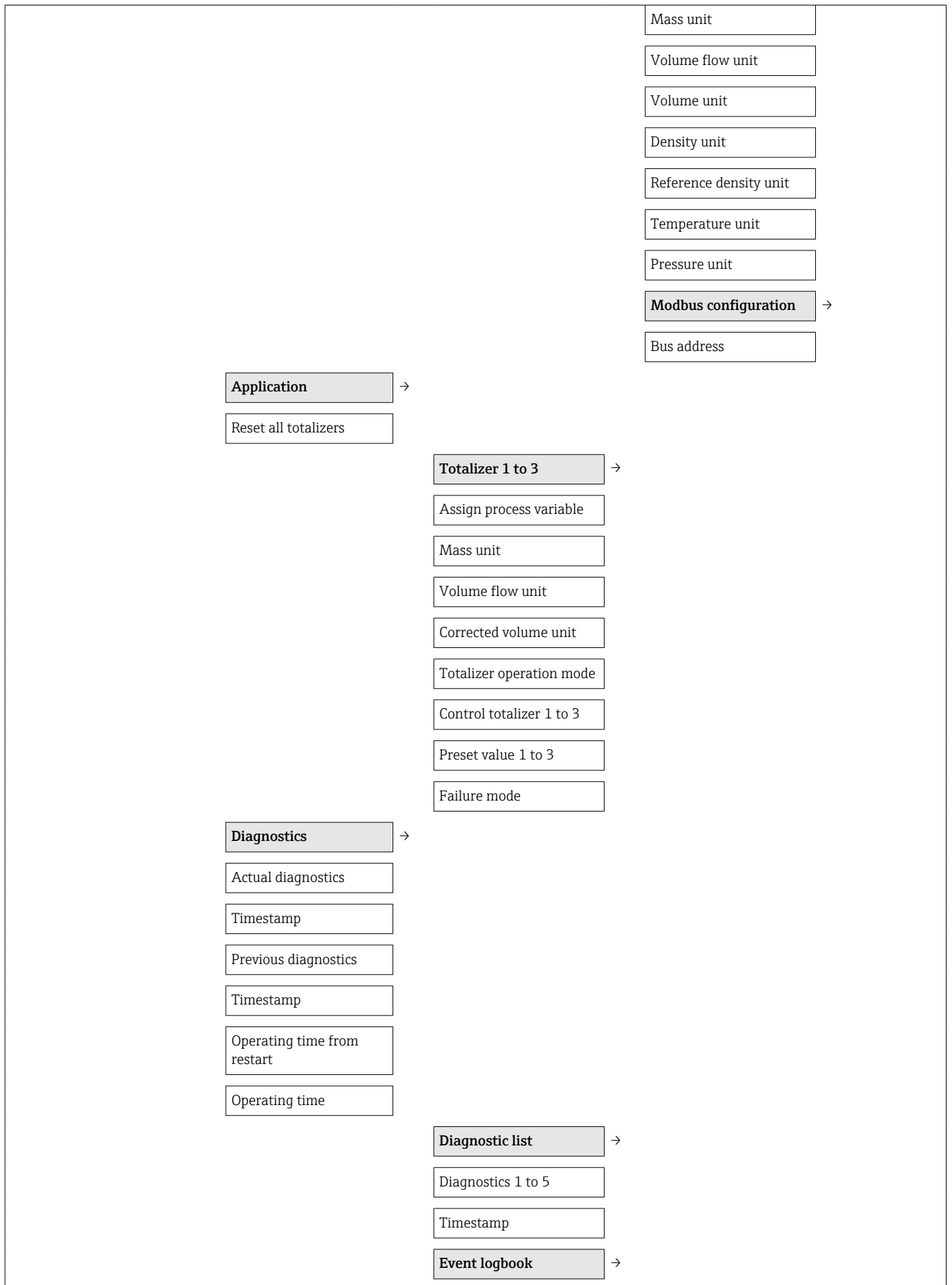

Filter options	
<b>Device information</b>	→
Device tag	
Serial number	
Firmware version	
Device name	
Order code	
Extended order code 1 to 3	
ENP version	
Configuration counter	
<b>Min/max values</b>	→
Reset min/max values	
	<b>Main electronic temperature</b> →
	Minimum value
	Maximum value
	<b>Medium temperature</b> →
	Minimum value
	Maximum value
	<b>Carrier pipe temperature</b> →
	Minimum value
	Maximum value
	<b>Oscillation frequency</b> →
	Minimum value
	Maximum value
	<b>Torsion oscillation frequency</b> →
	Minimum value
	Maximum value
	<b>Oscillation amplitude</b> →
	Minimum value
	Maximum value

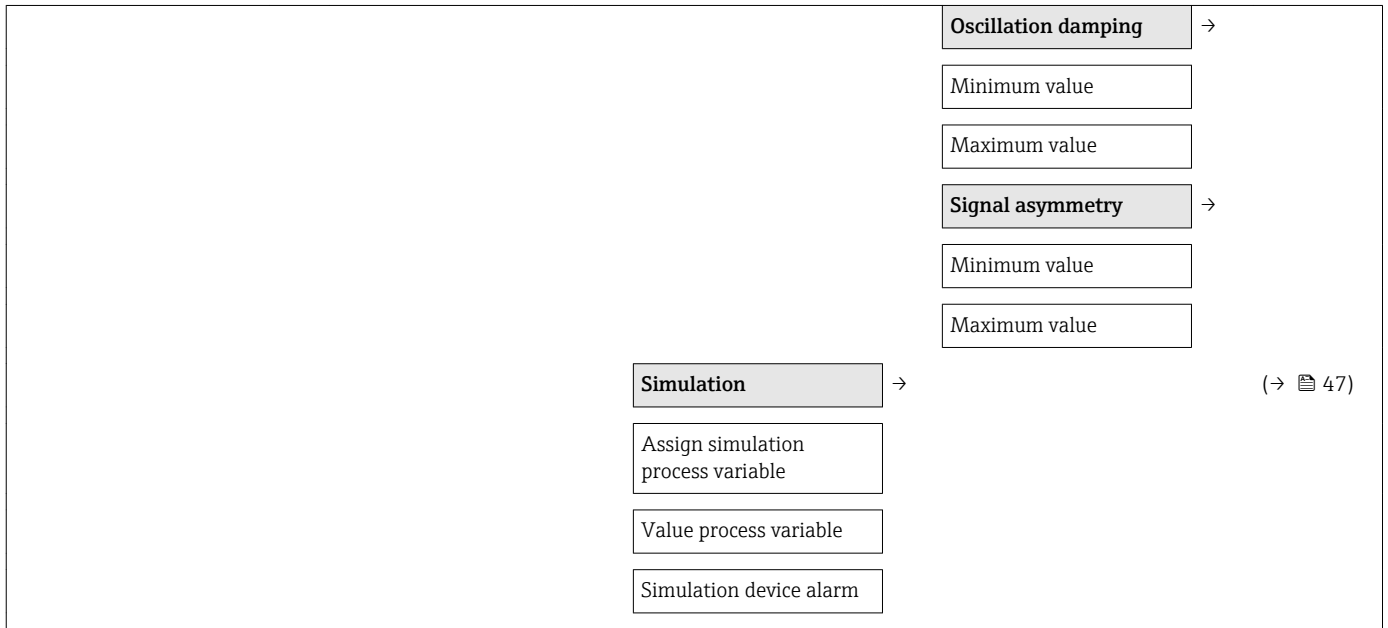

# Index

## A

- Accuracy . . . . . 70
- Adapting the diagnostic behavior . . . . . 56
- Ambient temperature range . . . . . 17
- Application . . . . . 8, 67
- Application packages . . . . . 75
- Approvals . . . . . 75
- Auto scan buffer
  - see Modbus RS485 Modbus data map

## C

- C-Tick symbol . . . . . 75
- Cable entries
  - Technical data . . . . . 70
- Cable entry
  - Degree of protection . . . . . 27
- CE mark . . . . . 9, 75
- Certificates . . . . . 75
- Check
  - Installation . . . . . 19
- Checklist
  - Post-connection check . . . . . 27
  - Post-installation check . . . . . 19
- Cleaning
  - CIP cleaning . . . . . 63
  - Exterior cleaning . . . . . 63
  - Interior cleaning . . . . . 63
  - SIP cleaning . . . . . 63
- Climate class . . . . . 71
- Commissioning . . . . . 37
  - Advanced settings . . . . . 45
  - Configuring the measuring device . . . . . 37
- Configuring error response mode, Modbus RS485 . . . . . 56
- Connecting cable . . . . . 20
- Connecting the measuring device . . . . . 24
- Connection
  - see Electrical connection
- Connection preparations . . . . . 23
- Connection tools . . . . . 20
- Current consumption . . . . . 69

## D

- Declaration of Conformity . . . . . 9
- Degree of protection . . . . . 27, 71
- Designated use . . . . . 8
- Device components . . . . . 11
- Device description files . . . . . 33, 33
- Device documentation
  - Supplementary documentation . . . . . 7
- Device locking, status . . . . . 50
- Device name
  - Sensor . . . . . 13
  - Transmitter . . . . . 13
- Device repair . . . . . 64
- Device revision . . . . . 33
- Device type ID . . . . . 33

## Diagnostic information

- Communication interface . . . . . 55
- Design, description . . . . . 55
- FieldCare . . . . . 54
- Light emitting diodes . . . . . 53
- Overview . . . . . 57
- Remedial measures . . . . . 57
- Diagnostic list . . . . . 59
- DIP switch
  - see Write protection switch
- Disabling write protection . . . . . 48
- Display
  - Current diagnostic event . . . . . 58
  - Previous diagnostic event . . . . . 58
- Display values
  - For locking status . . . . . 50
- Disposal . . . . . 64
- Document
  - Function . . . . . 5
  - Symbols used . . . . . 5
- Document function . . . . . 5

## E

- Electrical connection
  - CommuBox FXA291 . . . . . 31
  - Degree of protection . . . . . 27
  - Measuring device . . . . . 20
  - Operating tools
    - Via service interface (CDI) . . . . . 31
- Electromagnetic compatibility . . . . . 71
- Enabling write protection . . . . . 48
- Endress+Hauser services
  - Maintenance . . . . . 63
  - Repair . . . . . 64
- Error messages
  - see Diagnostic messages
- Event history . . . . . 59
- Events list . . . . . 59
- Ex approval . . . . . 75
- Extended order code
  - Sensor . . . . . 13
  - Transmitter . . . . . 13
- Exterior cleaning . . . . . 63

## F

- Field of application
  - Residual risks . . . . . 9
- FieldCare . . . . . 31
  - Device description file . . . . . 33
  - Establishing a connection . . . . . 31
  - Function . . . . . 31
  - User interface . . . . . 32
- Filtering the event logbook . . . . . 60
- Firmware
  - Release date . . . . . 33
  - Version . . . . . 33



- Firmware history . . . . . 62
- Flow direction . . . . . 19
- Flow limit . . . . . 72
- Function check . . . . . 37
- Function codes . . . . . 33
- Functions
  - see Parameter
- G**
- Galvanic isolation . . . . . 68
- H**
- Hardware write protection . . . . . 48
- I**
- I/O electronics module . . . . . 11, 24
- Identifying the measuring device . . . . . 12
- Incoming acceptance . . . . . 12
- Influence
  - Medium pressure . . . . . 71
  - Medium temperature . . . . . 71
- Information on the document . . . . . 5
- Inlet runs . . . . . 17
- Input . . . . . 67
- Inspection check
  - Connection . . . . . 27
  - Received goods . . . . . 12
- Installation . . . . . 17
- Installation conditions
  - Rupture disk . . . . . 17
  - Vibrations . . . . . 17
- Installation dimensions . . . . . 17
- Interior cleaning . . . . . 63
- L**
- Languages, operation options . . . . . 75
- Low flow cut off . . . . . 68
- M**
- Main electronics module . . . . . 11
- Maintenance tasks . . . . . 63
- Manufacturer ID . . . . . 33
- Manufacturing date . . . . . 13, 13
- Materials . . . . . 73
- Maximum measured error . . . . . 70
- Measured variables
  - see Process variables
- Measuring and test equipment . . . . . 63
- Measuring device
  - Configuration . . . . . 37
  - Conversion . . . . . 64
  - Disposal . . . . . 65
  - Integrating via HART protocol . . . . . 33
  - Mounting the sensor . . . . . 19
  - Preparing for electrical connection . . . . . 23
  - Preparing for mounting . . . . . 18
  - Removing . . . . . 64
  - Repair . . . . . 64
  - Structure . . . . . 11
- Measuring principle . . . . . 67
- Measuring range
  - For liquids . . . . . 67
- Measuring range, recommended . . . . . 72
- Measuring system . . . . . 67
- Media . . . . . 8
- Medium density . . . . . 72
- Medium pressure
  - Influence . . . . . 71
- Medium temperature
  - Influence . . . . . 71
- menu
  - Diagnostics . . . . . 58
  - Operation . . . . . 50
- Menus
  - For measuring device configuration . . . . . 37
  - For specific settings . . . . . 45
- Modbus RS485
  - Configuring error response mode . . . . . 56
  - Diagnostic information . . . . . 55
  - Function codes . . . . . 33
  - Modbus data map . . . . . 34
  - Read access . . . . . 33
  - Reading out data . . . . . 35
  - Register addresses . . . . . 34
  - Register information . . . . . 34
  - Response time . . . . . 34
  - Scan list . . . . . 35
  - Write access . . . . . 33
- Modbus RS485 certification . . . . . 75
- Mounting dimensions
  - see Installation dimensions
- Mounting preparations . . . . . 18
- Mounting requirements
  - Inlet and outlet runs . . . . . 17
  - Installation dimensions . . . . . 17
- Mounting tools . . . . . 18
- N**
- Nameplate
  - Safety Barrier Promass 100 . . . . . 14
  - Sensor . . . . . 13
  - Transmitter . . . . . 13
- O**
- Operable flow range . . . . . 67
- Operating menu
  - Menus, submenus . . . . . 29
  - Overview of menus with parameters . . . . . 77
  - Structure . . . . . 29
  - Submenus and user roles . . . . . 30
- Operating philosophy . . . . . 30
- Operation . . . . . 50
- Operation options . . . . . 28, 28
- Operational safety . . . . . 9
- Order code . . . . . 13, 13
- Outlet runs . . . . . 17
- Output . . . . . 68
- Output signal . . . . . 68
- Overview

Operating menu . . . . .	77	Medium temperature range . . . . .	72
<b>P</b>		Sensor	
Packaging disposal . . . . .	16	Medium temperature range . . . . .	71
Parameter settings		Mounting . . . . .	19
Advanced setup (submenu) . . . . .	37	Serial number . . . . .	13, 13
Calculated values (submenu) . . . . .	45	Service interface (CDI) . . . . .	74
Communication (submenu) . . . . .	40	Settings	
Device information (submenu) . . . . .	61	Adapting the measuring device to the process	
Diagnostics (menu) . . . . .	58	conditions . . . . .	51
Low flow cut off (wizard) . . . . .	43	Communication interface . . . . .	40
Operation (submenu) . . . . .	52	Device reset . . . . .	61
Partially filled pipe detection (wizard) . . . . .	44	Device tag . . . . .	37
Process variables (submenu) . . . . .	50	Low flow cut off . . . . .	43
Select medium (submenu) . . . . .	40	Medium . . . . .	40
Sensor adjustment (submenu) . . . . .	46	Partial filled pipe detection . . . . .	44
Simulation (submenu) . . . . .	47	Resetting the totalizer . . . . .	52
Totalizer (submenu) . . . . .	51	Sensor adjustment . . . . .	46
Totalizer 1 to 3 (submenu) . . . . .	46	Simulation . . . . .	47
Performance characteristics . . . . .	70	System units . . . . .	37
Post-connection check (checklist) . . . . .	27	Totalizer . . . . .	46
Post-installation check . . . . .	37	Totalizer reset . . . . .	52
Post-installation check (checklist) . . . . .	19	Shock resistance . . . . .	71
Potential equalization . . . . .	70	Signal on alarm . . . . .	68
Power consumption . . . . .	69	Software release . . . . .	33
Power supply failure . . . . .	70	Spare part . . . . .	64
Pressure loss . . . . .	72	Spare parts . . . . .	64
Pressure range		Status signals . . . . .	55
Medium pressure . . . . .	72	Storage conditions . . . . .	15
Pressure-temperature ratings . . . . .	72	Storage temperature . . . . .	15
Process connections . . . . .	74	Structure	
Process variables		Measuring device . . . . .	11
Measured . . . . .	67	Operating menu . . . . .	29
Product safety . . . . .	9	submenu	
Protecting parameter settings . . . . .	48	Advanced setup . . . . .	37, 45
<b>R</b>		Calculated values . . . . .	45
Reading measured values . . . . .	50	Communication . . . . .	40
Reading out diagnostic information, Modbus RS485 . . . . .	55	Device information . . . . .	61
Recalibration . . . . .	63	Operation . . . . .	52
Reference operating conditions . . . . .	70	Process variables . . . . .	50
Registered trademarks . . . . .	7	Select medium . . . . .	40
Remote operation . . . . .	74	Sensor adjustment . . . . .	46
Repair . . . . .	64	Simulation . . . . .	47
Notes . . . . .	64	Totalizer . . . . .	51
Repair of a device . . . . .	64	Totalizer 1 to 3 . . . . .	46
Repeatability . . . . .	70	Submenu	
Replacement		Events list . . . . .	59
Device components . . . . .	64	Overview . . . . .	30
Requirements for personnel . . . . .	8	Process variables . . . . .	45
Response time . . . . .	71	Supply voltage . . . . .	69
Returning devices . . . . .	64	System design	
Rupture disk		Measuring system . . . . .	67
Safety instructions . . . . .	17	see Measuring device design	
Triggering pressure . . . . .	72	System integration . . . . .	33
<b>S</b>		<b>T</b>	
Safety . . . . .	8	Technical data, overview . . . . .	67
Seals		Temperature range	
		Medium temperature . . . . .	71
		Storage temperature . . . . .	15

Terminal assignment . . . . .	22, 24
Terminals . . . . .	70
Tools	
Electrical connection . . . . .	20
Installation . . . . .	18
Transport . . . . .	15
Transmitter	
Connecting the signal cables . . . . .	24
Transporting the measuring device . . . . .	15
Troubleshooting	
General . . . . .	53
<b>U</b>	
Use of the measuring device	
Borderline cases . . . . .	8
Incorrect use . . . . .	8
see Designated use	
User roles . . . . .	30
<b>V</b>	
Version data for the device . . . . .	33
Vibration resistance . . . . .	71
Vibrations . . . . .	17
<b>W</b>	
W@M . . . . .	63, 64
W@M Device Viewer . . . . .	12, 64
Weight	
SI units . . . . .	73
Transport (notes) . . . . .	15
US units . . . . .	73
wizard	
Low flow cut off . . . . .	43
Partially filled pipe detection . . . . .	44
Workplace safety . . . . .	9
Write protection	
Via write protection switch . . . . .	48
Write protection switch . . . . .	48

[www.addresses.endress.com](http://www.addresses.endress.com)

---