

Operating Instructions

CNGmass

Modbus RS485

Coriolis flowmeter

For fueling with compressed natural gas (CNG)

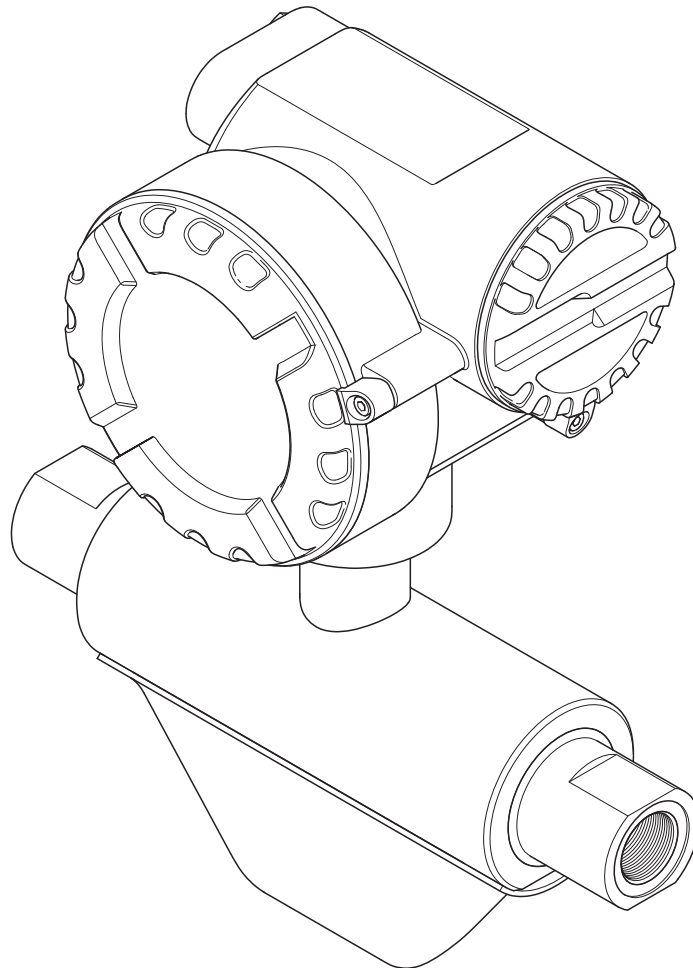

Table of contents

1	Safety instructions	4	10	Accessories	36
1.1	Designated use	4	10.1	Device-specific accessories	36
1.2	Installation, commissioning and operation	4	10.2	Service-specific accessories	36
1.3	Operational safety	4	10.3	System components	37
1.4	Return	5	11	Troubleshooting	38
1.5	Notes on safety conventions and icons	5	11.1	Self-monitoring	38
1.6	Symbols on nameplates	5	11.2	Diagnosis using light emitting diode (LED)	39
2	Identification	6	11.3	Messages (FieldCare)	40
2.1	Device designation	6	11.4	Errors without messages	42
2.2	Certificates and approvals	8	11.5	Spare parts	42
2.3	Registered trademarks	8	11.6	Response of outputs to errors	43
3	Incoming acceptance, transport and storage	9	11.7	Removing and installing the meter electronics .	44
3.1	Incoming acceptance	9	11.8	Return	45
3.2	Transport	9	11.9	Disposal	45
3.3	Storage	9	11.10	Software history	45
4	Installation	10	12	Technical data	46
4.1	Installation conditions	10	12.1	Applications	46
4.2	Installation instructions	11	12.2	Function and system design	46
4.3	Post-installation check	11	12.3	Input	46
5	Wiring	12	12.4	Output	46
5.1	Modbus RS485 cable specifications	12	12.5	Power supply	47
5.2	Connecting the measuring unit	14	12.6	Performance characteristics	48
5.3	Degree of protection	15	12.7	Installation	49
5.4	Post-connection check	16	12.8	Environment	49
6	Operation	17	12.9	Process	49
6.1	Quick operation guide	17	12.10	Mechanical construction	50
6.2	Modbus RS485 communication	18	12.11	Operability	50
6.3	Operating options	30	12.12	Certificates and approvals	51
7	Commissioning	31	12.13	Accessories/spare parts	51
7.1	Function check	31	12.14	Documentation	52
7.2	Switching on the measuring device	31	13	Appendix – Device Functions	53
7.3	Zero point adjustment	31	13.1	Display of function matrix	54
7.4	Memory (HistoROM)	32	13.2	Block "SECURITY"	58
8	Custody transfer measurement	33	13.3	Block "MEASURED VARIABLE"	58
8.1	Suitability for custody transfer measurement, approval by the Standards Authorities, repeated calibration due to legal metrology controls ...	33	13.4	Block "TOTALIZER"	62
9	Maintenance	35	13.5	Block "OUTPUTS"	65
9.1	External cleaning	35	13.6	Block "BASIC FUNCTION"	78
			13.7	Block "SUPERVISION"	93
			Index	101	

1 Safety instructions

1.1 Designated use

The measuring device described in these operating instructions may be used for measuring the mass or volume flow measurement of Compressed Natural Gas (CNG).

Resulting from incorrect use or from use other than that designated the operational safety of the measuring devices can be suspended. The manufacturer accepts no liability for damages being produced from this.





1.2 Installation, commissioning and operation

Note the following points:

- Installation, connection to the electricity supply, commissioning and maintenance of the measuring device must be carried out by trained, qualified specialists authorized to perform such work by the facility's owner-operator. The specialist must have read and understood these Operating Instructions and must follow the instructions they contain.
- The device must be operated by persons authorized and trained by the facility's owner-operator. Strict compliance with the instructions in the Operating Instructions is mandatory.
- The CNGmass is a device for measuring gas under high pressure. Therefore, professional design of the system and proper installation of all pressure-bearing parts is of vital importance for long-term safe operation.
- Endress+Hauser will be happy to assist in clarifying the corrosion resistance properties of materials wetted by special fluids, including fluids used for cleaning. However, small changes of temperature, concentration or degree of contamination in the process can result in differences in corrosion resistance. Therefore, Endress+Hauser provides no warranty and assumes no liability with regard to corrosion resistance of fluid wetted materials in any given application. The user is responsible for choosing suitable fluid wetted materials in the process.
- The installer must ensure that the measuring system is correctly wired in accordance with the wiring diagrams.
- The user must attach an external switch for disconnecting the power supply in an emergency. The relationship between this switch and the measuring instrument or part of the system in which the instrument is located must be identified clearly and unambiguously.
- Invariably, local regulations governing the maintenance and repair of electrical devices apply.

1.3 Operational safety

Note the following points:

- Measuring systems for use in hazardous environments are accompanied by separate "Ex documentation", which is an integral part of these Operating Instructions. Strict compliance with the installation instructions and ratings as stated in this supplementary documentation is mandatory. The symbol on the front of this supplementary Ex documentation indicates the approval and the inspection body ( Europe,  USA,  Canada).
- The housing of the sensor is equipped with a rupture disk to prevent the pressure in the sensor housing from increasing in the event of an error. As long as the adhesive label (→  10) is intact, the rupture disk is also intact.
- The measuring device complies with the general safety requirements in accordance with EN 61010, the EMC requirements of IEC/EN 61326, and NAMUR recommendation NE 21.

- The manufacturer reserves the right to modify technical data without prior notice. Your Endress+Hauser distributor will supply you with current information and any updates to these Operating Instructions.

1.4 Return

- Do not return a measuring device if you are not absolutely certain that all traces of hazardous substances have been removed, e.g. substances which have penetrated crevices or diffused through plastic.
- Costs incurred for waste disposal and injury (burns, etc.) due to inadequate cleaning will be charged to the owner-operator.
- Please note the measures on →  45

1.5 Notes on safety conventions and icons

The devices are designed to meet state-of-the-art safety requirements, have been tested, and left the factory in a condition in which they are safe to operate. The devices comply with the applicable standards and regulations in accordance with EN 61010 "Safety requirements for electrical equipment for measurement, control and laboratory use". They can, however, be a source of danger if used incorrectly or for other than the designated use. Consequently, always pay particular attention to the safety instructions indicated in these Operating Instructions by the following icons:



Warning!

"Warning" indicates an action or procedure which, if not performed correctly, can result in injury or a safety hazard. Comply strictly with the instructions and proceed with care.



Caution!

"Caution" indicates an action or procedure which, if not performed correctly, can result in incorrect operation or destruction of the measuring device. Comply strictly with the instructions.



Note!

"Note" indicates an action or procedure which, if not performed correctly, can have an indirect effect on operation or trigger an unexpected response on the part of the device.

1.6 Symbols on nameplates

The following symbol appears on nameplates (refer to the corresponding documentation):



In the case of devices for potentially explosive atmospheres, a documentation code appears, representing supplementary Ex documentation that it is mandatory to read.

2 Identification

The following options are available for identification of the measuring device:

- Nameplate specifications.
- Order code with breakdown of the device features on the delivery note.
- Enter serial numbers from nameplates in *W@M Device Viewer* (www.endress.com/deviceviewer): All information about the measuring device is displayed.

For an overview of the scope of the Technical Documentation provided, refer to the following:

- The chapters "Documentation" →  52.
- The *W@M Device Viewer*: Enter the serial number from the nameplate (www.endress.com/deviceviewer).

Reorder

The measuring device is reordered using the order code.

Extended order code:

- The device type (product root) and basic specifications (mandatory features) are always listed.
- Of the optional specifications (optional features), only the safety and approval-related specifications are listed (e.g. LA). If other optional specifications are also ordered, these are indicated collectively using the # placeholder symbol (e.g. #LA#).
- If the ordered optional specifications do not include any safety and approval-related specifications, they are indicated by the + placeholder symbol (e.g. 8FF***-AACCCAAD2S1+).

2.1 Device designation

The flow measuring system is a compact measuring device.

2.1.1 Nameplate of the transmitter

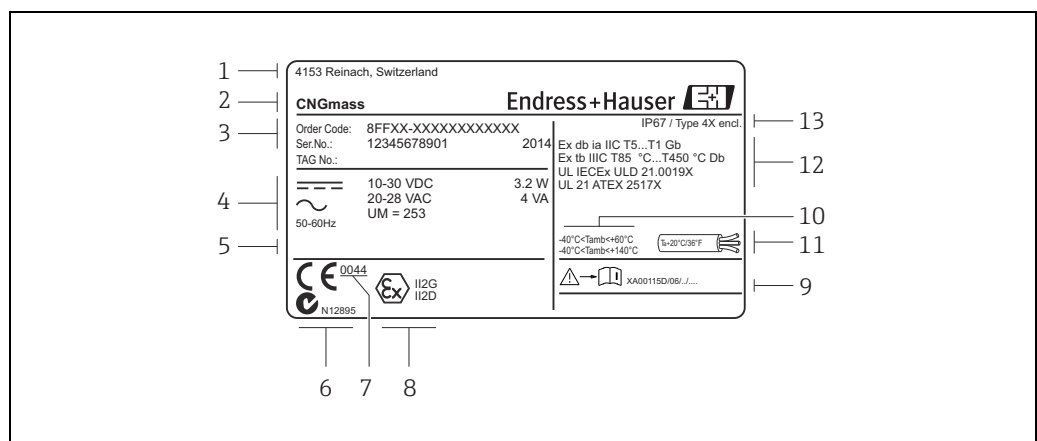

Fig. 1: Nameplate data for the transmitter (example)

- 1 Production site
- 2 Type of device
- 3 Order code / Serial number / Year of manufacture: See the specifications on the order confirmation for the meanings of the individual letters and digits
- 4 Power supply / frequency / power consumption
- 5 Reserved for information on special products
- 6 C-Tick symbol
- 7 Notified body for quality assurance monitoring
- 8 Equipment group and equipment category as per directive 2014/34/EU (ATEX)
- 9 Associated Ex documentation
- 10 Permitted ambient temperature
- 11 Cable temperature
- 12 Identification of the type of protection, explosion group, temperature class, ingress protection as well as number of EC type-examination certificate
- 13 Degree of protection

2.1.2 Nameplate of the sensor

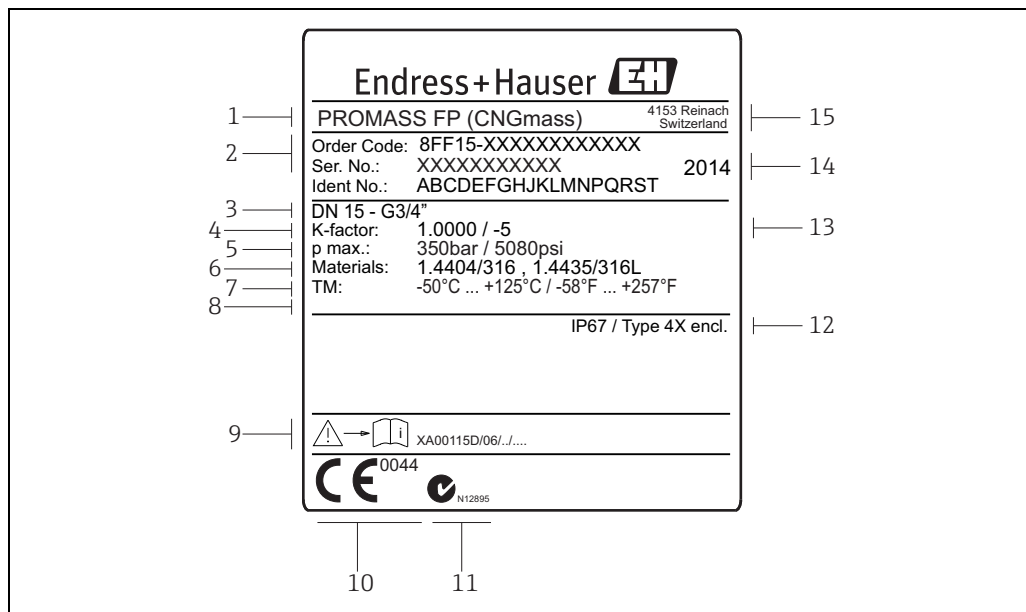

Fig. 2: Nameplate data for the sensor (example)

- 1 Sensor type
- 2 Order code / Serial number: See the specifications on the order confirmation for the meanings of the individual letters and digits
- 3 Process connection
- 4 Flow calibration factor
- 5 Maximum process pressure
- 6 Materials
- 7 Process temperature range
- 8 Reserved for information on special products
- 9 Associated Ex documentation
- 10 Notified body for quality assurance monitoring
- 11 C-Tick symbol
- 12 Degree of protection
- 13 Additional information: with 5-point calibration
- 14 Year of manufacture
- 15 Production site

2.1.3 Additional name plate for approval for custody transfer

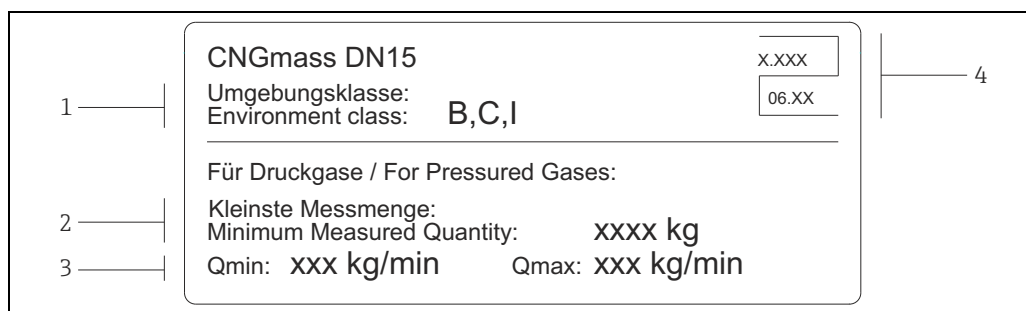

Fig. 3: Additional plate for the approval for custody transfer (example)

- 1 Ambient classes
- 2 Minimum measurement quantity for compressed gases
- 3 Flow measuring range Q_{min} to Q_{max} in kg/min
- 4 Symbol for custody transfer consisting of the number and issue date

2.1.4 Nameplate for connections

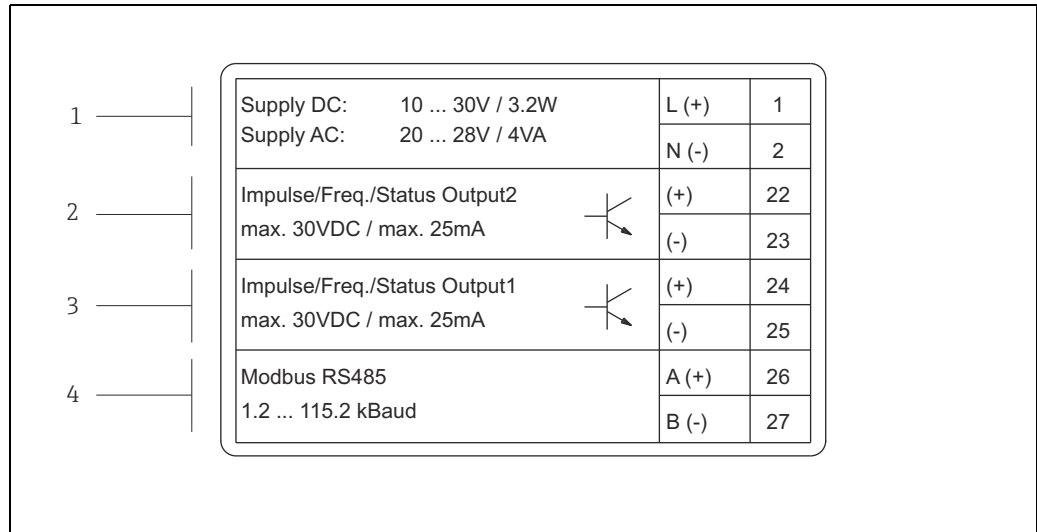

Fig. 4: Nameplate specifications for transmitter connections (example)

- 1 Terminal assignment for power supply
- 2 Terminal assignment pulse/frequency/status output
- 3 Terminal assignment pulse/frequency/status output
- 4 Terminal assignment Modbus RS485

2.2 Certificates and approvals

The devices are designed in accordance with good engineering practice to meet state-of-the-art safety requirements, have been tested, and left the factory in a condition in which they are safe to operate.

The measuring devices comply with the applicable standards and regulations in accordance with EN 61010 -1, "Safety requirements for electrical equipment for measurement, control and laboratory use" and with the EMC requirements of IEC/EN 61326.

The measuring system described in these Operating Instructions thus complies with the statutory requirements of the EC Directives. Endress+Hauser confirms successful testing of the device by affixing to it the CE mark.

The measuring system meets the EMC requirements of the Australian Communications and Media Authority (ACMA).

The measuring device meets all the requirements of the Modbus/TCP conformity and integration test and holds the "Modbus/TCP Conformance Test Policy, Version 2.0". The measuring device has successfully passed all the test procedures carried out and is certified by the "Modbus/TCP Conformance Test Laboratory" of the University of Michigan.

2.3 Registered trademarks

Modbus®

Registered trademark of the SCHNEIDER AUTOMATION, INC.

Applicator®, FieldCare®, HistoROM™, S-DAT®

Registered or registration-pending trademarks of the Endress+Hauser Group

3 Incoming acceptance, transport and storage

3.1 Incoming acceptance

On receipt of the goods, check the following points:

- Is the packaging or content damaged?
- Is anything missing from the shipment and does the scope of supply match your order?

3.2 Transport

Comply with the following instructions when unpacking the device and transporting it to its final location:

- Transport the devices in the containers in which they are delivered.
- The covers or caps fitted to the process connections prevent mechanical damage to the sealing faces and the ingress of foreign matter to the measuring tube during transportation and storage. Consequently, do not remove these covers or caps until immediately before installation.

3.3 Storage

Note the following points:

- Pack the measuring device in such a way as to protect it reliably against impact for storage (and transportation). The original packaging provides optimum protection.
- The permitted storage temperature is -40 to $+80$ °C (-40 to 176 °F), preferably $+20$ °C ($+68$ °F).
- Do not remove the protective caps on the process connections until you are ready to install the device.
- The measuring device must be protected against direct sunlight during storage in order to avoid unacceptably high surface temperatures.

4 Installation

4.1 Installation conditions

No special measures such as supports are necessary. Design features of the instrument absorb external forces.

4.1.1 Dimensions

All the dimensions and lengths of the sensor and transmitter are provided in the separate documentation entitled "Technical Information" →  52.

4.1.2 Inlet and outlet runs

No special precautions need to be taken for fittings which create turbulence (valves, elbows, T-pieces etc.).

4.1.3 Vibrations

The high oscillation frequency of the measuring tubes ensures that the correct operation of the measuring system is not influenced by pipe vibrations. Consequently, the sensors require no special measures for attachment.

4.1.4 Limiting flow

Limiting flow information →  46.

4.1.5 Special installation instructions

Rupture disk

Make sure that the function and operation of the rupture disk is not impeded through the installation of the device. The position of the rupture disk is indicated on a sticker applied over it. If the rupture disk is triggered, the sticker is destroyed. The disk can therefore be visually monitored. For additional information that is relevant to the process (→  49).

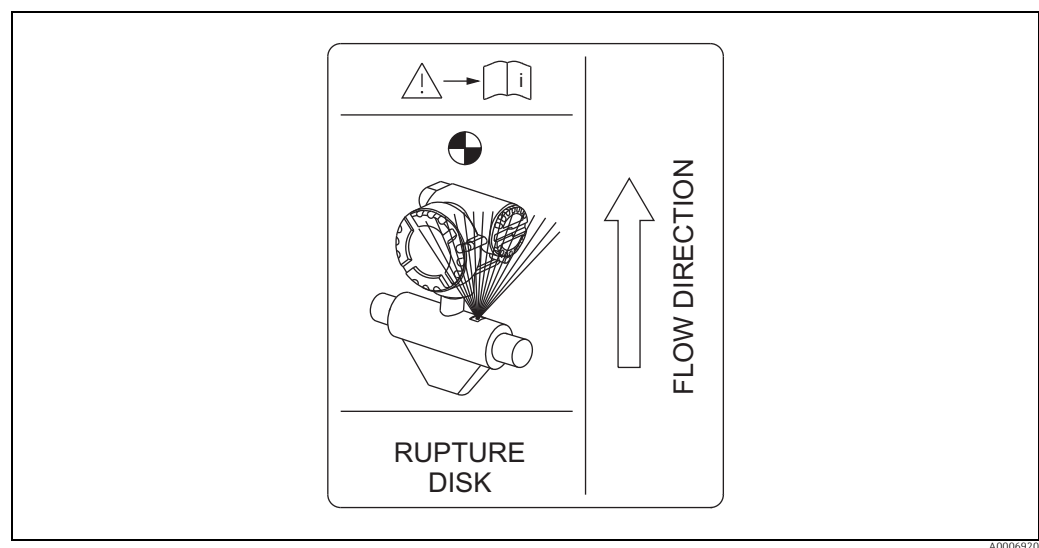

Fig. 5: Indication label for the rupture disk

A0006920

4.2 Installation instructions

4.2.1 Turning the transmitter housing

The transmitter housing can be rotated counterclockwise continuously up to 360°.

1. Loosen the Allen setscrew (1) partially, but do not unscrew it all the way.
2. Rotate the transmitter housing into the desired position.
3. Tighten the Allen setscrew (1).

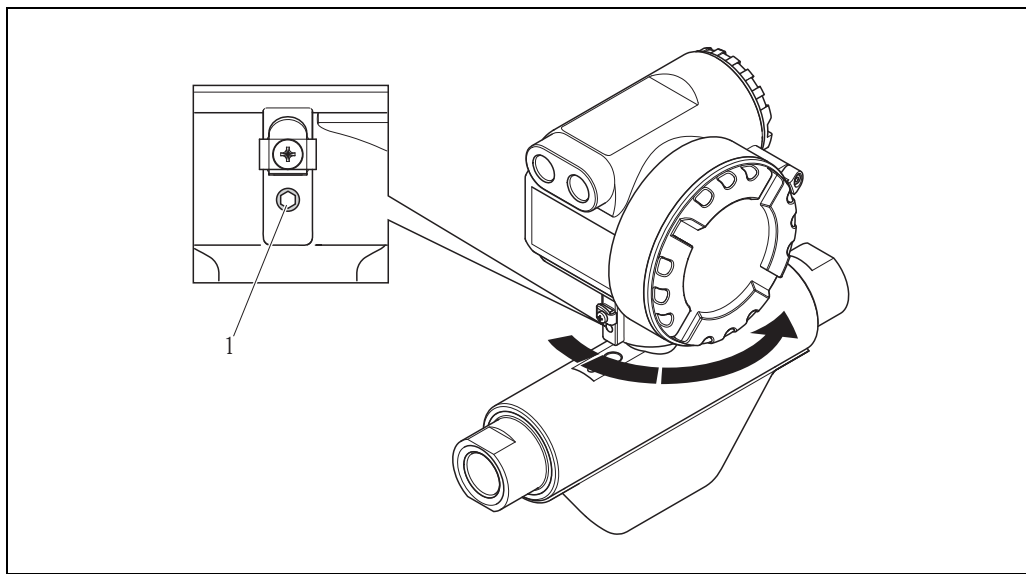

Fig. 6: Rotating the transmitter housing

4.3 Post-installation check

Perform the following checks after installing the measuring device in the pipe:

Device condition and specifications	Notes
Is the measuring instrument damaged, particularly the sealing surfaces of the process connection (visual inspection)?	-
Is the adhesive label of the rupture disk intact?	→ 10
Does the device correspond to specifications at the measuring point, including process temperature and pressure, ambient temperature, measuring range etc.?	→ 49
Installation	Notes
Do the process connections used correspond to the existing process conditions (pressure, temperature) and the specified seal design on the sensor side?	-
Does the arrow on the sensor nameplate match the direction of flow through the pipe?	-
Are the measuring point number and labeling correct (visual inspection)?	-
Is the orientation chosen for the sensor correct, in other words suitable for sensor type and fluid temperature?	→ 10
Process environment / process conditions	Notes
Is the measuring device protected against moisture and direct sunlight?	-

5 Wiring



Warning!

When connecting Ex-certified devices, see the notes and diagrams in the Ex-specific supplement to these Operating Instructions. Please do not hesitate to contact your Endress+Hauser sales office if you have any questions.



Note!

The measuring device does not have an internal disconnecting device. Therefore, assign a switch or circuit breaker to the measuring device with which the voltage supply line can be disconnected from the power system.

5.1 Modbus RS485 cable specifications

In the EIA/TIA-485 standard, two versions (cable type A and B) are specified for the bus line and can be used for all transmission rates. However, we recommend you use cable type A. The cable specification for cable type A is provided in the following table:

Cable type A	
Characteristic impedance	120 Ω
Cable capacitance	< 30 pF/m (< 9.2 pF/ft)
Core cross-section	> 0.34 mm ² (AWG 22)
Cable type	Twisted pairs
Loop-resistance	$\leq 110 \Omega/\text{km}$ ($\leq 0.034 \Omega/\text{ft}$)
Signal damping	Max. 9 dB over the entire length of the cable cross-section
Shielding	Copper braided shielding or braided shielding and foil shielding

Note the following points for the bus structure:

- All the measuring devices are connected in a bus structure (line).
- Using cable type A and with a transmission rate of 115200 Baud, the maximum line length (segment length) of the Modbus RS485 system is 1200 m (3936 ft).
The total length of the spurs may not exceed a maximum of 6.6 m (21.7 ft) here.
- A maximum of 32 users are permitted per segment.
- Each segment is terminated at either end with a terminating resistor.
- The bus length or the number of users can be increased by introducing a repeater.

5.1.1 Shielding and grounding

When planning the shielding and grounding for a fieldbus system, there are three important points to consider:

- Electromagnetic compatibility (EMC)
- Explosion protection
- Employee safety

To ensure the optimum electromagnetic compatibility of systems, it is important that the system components and above all the cables, which connect the components, are shielded and that no portion of the system is unshielded. Ideally, the cable shields are connected to the normally metal housings of the connected field devices. Since these are generally connected to the protective ground, the shield of the bus cable is grounded many times. Make sure that the stripped and twisted lengths of cable shield to the terminals are as short as possible.

This approach, which provides the best electromagnetic compatibility and employee safety, can be used without restriction in systems with optimum potential equalization.

In the case of systems without potential equalization, a mains frequency (50 Hz) equalizing current can flow between two grounding points which can destroy the cable in unfavorable cases, e.g. when it exceeds the permissible shield current.

To suppress the low frequency equalizing currents on systems without potential equalization, it is therefore recommended to connect the cable shield directly to the building ground (or protective ground) at one end only and to use capacitive coupling to connect all other grounding points.



Caution!

The legal EMC requirements are fulfilled **only** when the cable shield is grounded on both sides.

5.2 Connecting the measuring unit

5.2.1 Transmitter connection



Warning!

- Risk of electric shock. Switch off the power supply before opening the device. Do not install or wire the device while it is connected to the power supply. Failure to comply with this precaution can result in irreparable damage to the electronics.
- Risk of electric shock. Connect the protective ground to the ground terminal on the housing before the power supply is applied unless special protection measures have been taken.
- Compare the specifications on the nameplate with the local supply voltage and frequency. The national regulations governing the installation of electrical equipment also apply.

1. Detach the safety claw (a) and remove the cover of the connection compartment (b) from the transmitter housing.
2. Feed the signal cable (c) and power supply cable (d) through the appropriate cable entries.
3. Perform wiring in accordance with the terminal assignment (→ 15).
4. Screw the cover of the connection compartment (b) firmly onto the transmitter housing and retighten the safety claw (a).

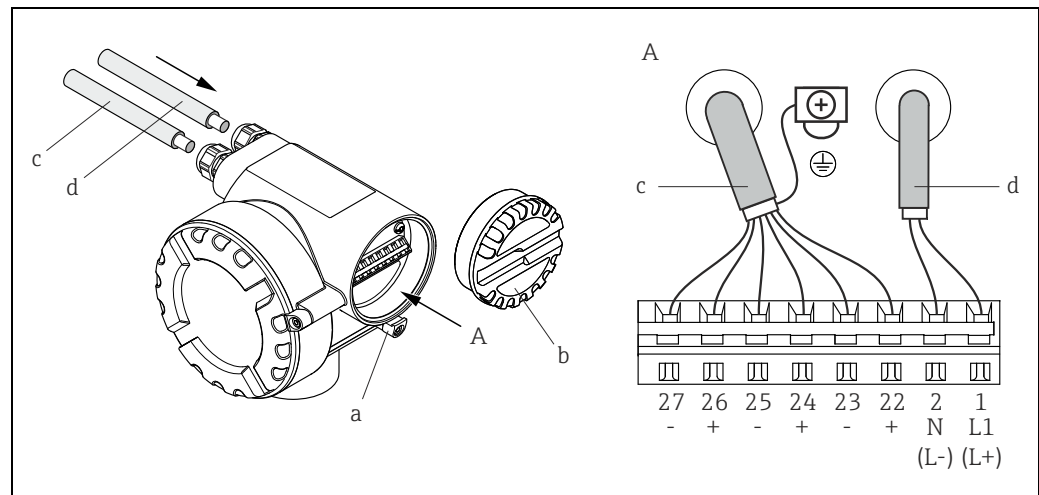

Fig. 7: Connecting the transmitter, cable cross-section: max. 2.5 mm² (14 AWG)

A View A

a Safety claw

b Connection compartment cover

c Signal cable: terminal Nos. 22 to 27
(shield is mandatory)

d Cable for power supply: 20 to 28 V AC, 10 to 30 V DC

- Terminal No. 1: L1 for AC, L+ for DC

- Terminal No. 2: N for AC, L- for DC



Caution!

- The behavior of the measuring instrument below a supply voltage of 10 VDC is not defined. Correct function can no longer be guaranteed. We recommend switching off the measuring instrument if the supply voltage falls below that specified.
- Operation at a supply voltage of 30 VDC or 28 VAC can destroy the measuring instrument. We recommend limiting the supply voltage to the specified range using corresponding protective elements or other measures.

5.2.2 Terminal assignment

Electrical values for outputs → 46.

Order characteristic for "inputs/outputs"	Terminal No. (outputs)		
	22 (+) / 23 (-)	24 (+) / 25 (-)	26 (+) / 27 (-)
Fixed communication board (permanent assignment)			
N	Pulse / frequency /status output 2	Pulse / frequency /status output 1	Modbus RS485

5.3 Degree of protection

The measuring device fulfills all the requirements for IP 67.

Compliance with the following points is mandatory following installation in the field or servicing, in order to ensure that IP 67 protection is maintained:

- The housing seals must be clean and undamaged when inserted into their grooves. The seals must be dried, cleaned or replaced if necessary.
- The screws and screw covers must be firmly tightened.
- The cables used for connection must be of the specified outside diameter (8 to 12 mm / 0.32 to 0.47").
- The cable entries must be firmly tightened (point **a** → 8).
- The cable must loop down in front of the cable entry ("water trap") (point **b** → 8). This arrangement prevents moisture penetrating the entry.

 Note!

The cable entries may not point up.

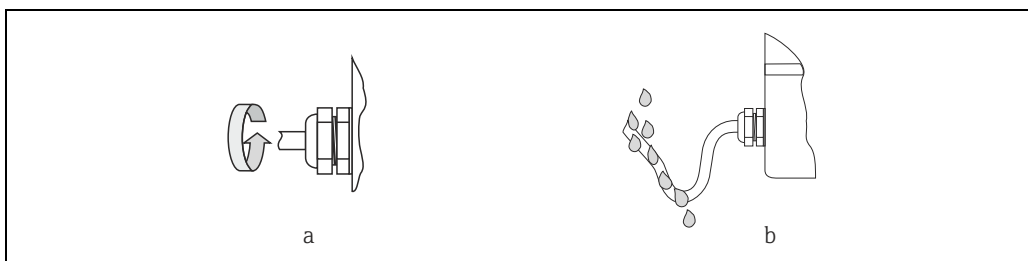

Fig. 8: Installation instructions, cable entries

- Remove all unused cable entries and insert plugs instead.
- Do not remove the grommet from the cable entry.









Caution!

Do not loosen the screws of the sensor housing, as otherwise the degree of protection guaranteed by Endress+Hauser no longer applies.

5.4 Post-connection check

Perform the following checks after completing electrical installation of the measuring device:

Device condition and specifications	Notes
Are cables or the device damaged (visual inspection)?	–
Electrical connection	Notes
Does the supply voltage match the specifications on the nameplate? Is the protective ground connected?	20 to 28 V AC (45 to 65 Hz) 10 to 30 V DC
Do the cables comply with the specifications?	→  12
Do the cables have adequate strain relief?	–
Is the cable type route completely isolated? Without loops and crossovers?	–
Are the power supply and signal cables correctly connected?	→ Wiring diagram inside the cover of the terminal compartment
Are all screw terminals firmly tightened?	–
Are all cable entries installed, firmly tightened and correctly sealed? Cables looped as "water traps"?	→  15, "Degree of protection" section
Are all housing covers installed and firmly tightened?	–
Fieldbus electrical connection	Notes
Has each fieldbus segment been terminated at both ends with a bus terminator?	→  12
Has the max. length of the fieldbus cable been observed in accordance with the specifications?	→  12
Has the max. length of the spurs been observed in accordance with the specifications?	→  12
Is the fieldbus cable fully shielded and correctly grounded?	→  13

6 Operation

6.1 Quick operation guide

You have the following option for configuring and commissioning the device:

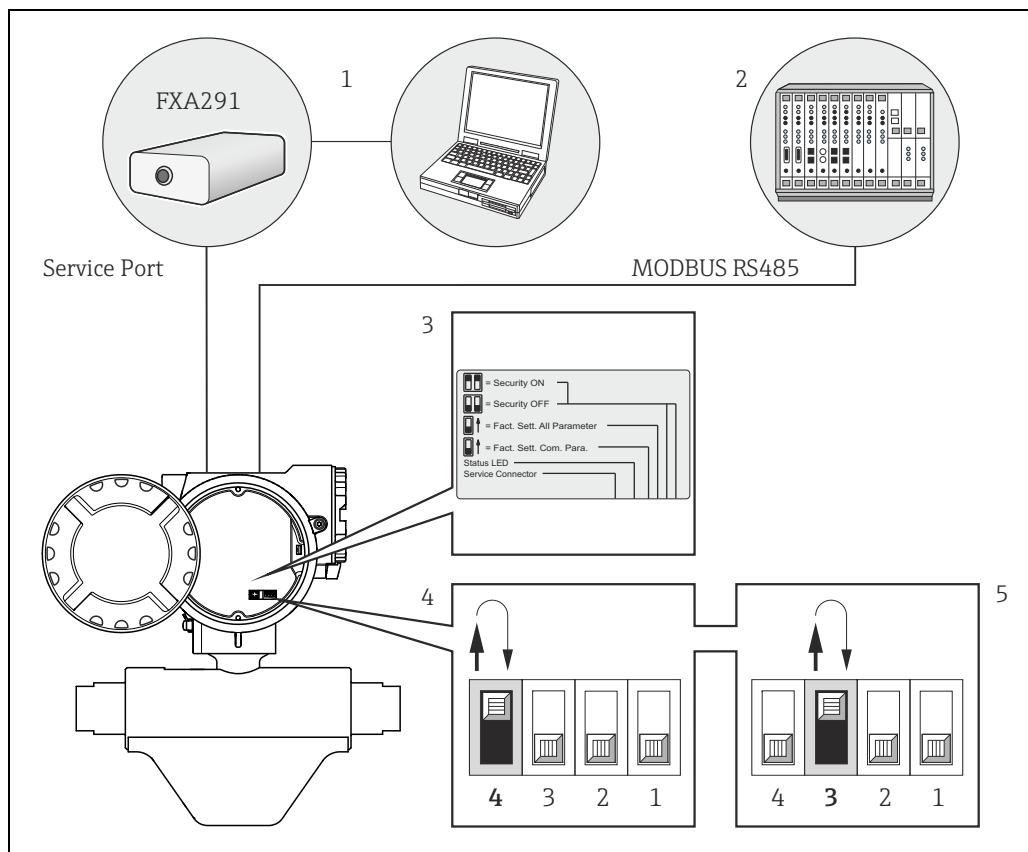

Fig. 9: Method of operating Modbus RS485 devices

- 1 Configuration/operating program for operating via the service interface FXA291 (e.g. FieldCare)
- 2 Operation via Modbus RS485 process control system
- 3 Situation sticker of the various DIP switch positions and their function (explanations of DIP switches 2 and 1 → 34 et seq.)
- 4 Operation via device-internal DIP switch (4):
If the DIP switch (4) is switched upwards, the device restores the factory settings of the communication parameters of the Modbus RS485 (return it afterwards to its original lower position).
- 5 Operation via device-internal DIP switch (3):
If the DIP switch (3) is switched upwards, the device restores the factory settings of all communication parameters of the Modbus RS485 (return it afterwards to its original lower position).



Note!

The DIP switches must stay at least 2 second in the desired position, until the appropriate reaction takes place. Setting back parameters can require several minutes, followed by a start-up of the device. Meanwhile the light emitting diode permanently shines orange. The power supply must not be switched off while the factory settings are being restored.

6.2 Modbus RS485 communication

6.2.1 Modbus RS485 technology

The Modbus is an open, standardized fieldbus system which is deployed in the areas of manufacturing automation, process automation and building automation.

System architecture

The Modbus RS485 is used to specify the functional characteristics of a serial fieldbus system with which distributed, digital automation systems are networked together.

The Modbus RS485 distinguishes between master and slave devices.

■ Master devices

Master devices determine the data traffic on the fieldbus system. They can send data without an external request.

■ Slave devices

Slave devices, like this measuring device, are peripheral devices. They do not have their own access rights to the data traffic of the fieldbus system and only send their data due to an external request from a master.

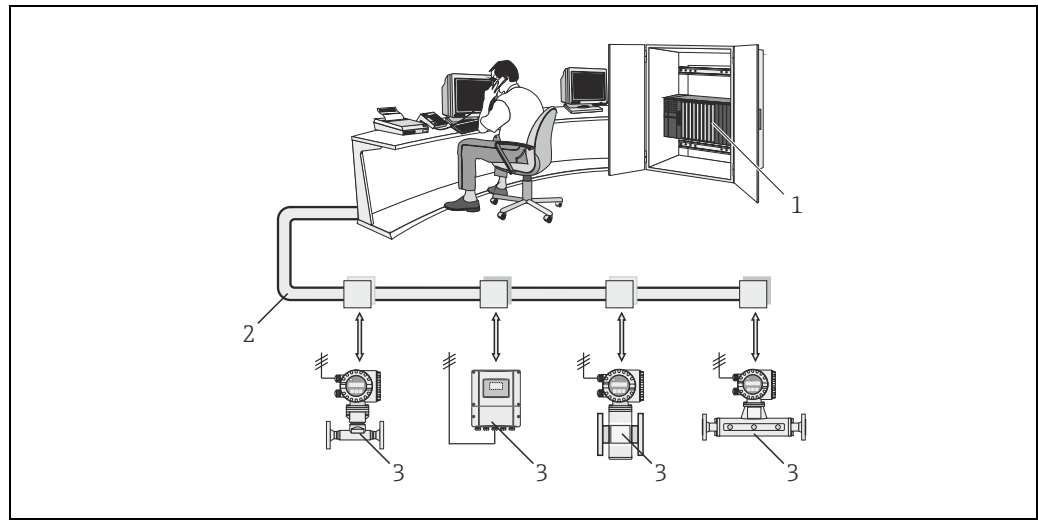

Fig. 10: Modbus RS485 system architecture

- 1 Modbus master (PLC etc.)
- 2 Modbus RS485
- 3 Modbus slave (measuring devices etc.)

Master/slave communication

A distinction is made between two methods of communication with regard to master/slave communication via Modbus RS485:

■ **Polling (request-response-transaction)**

The master sends a request telegram to **one** slave and waits for the slave's response telegram. Here, the slave is contacted directly due to its unique bus address (1 to 247).

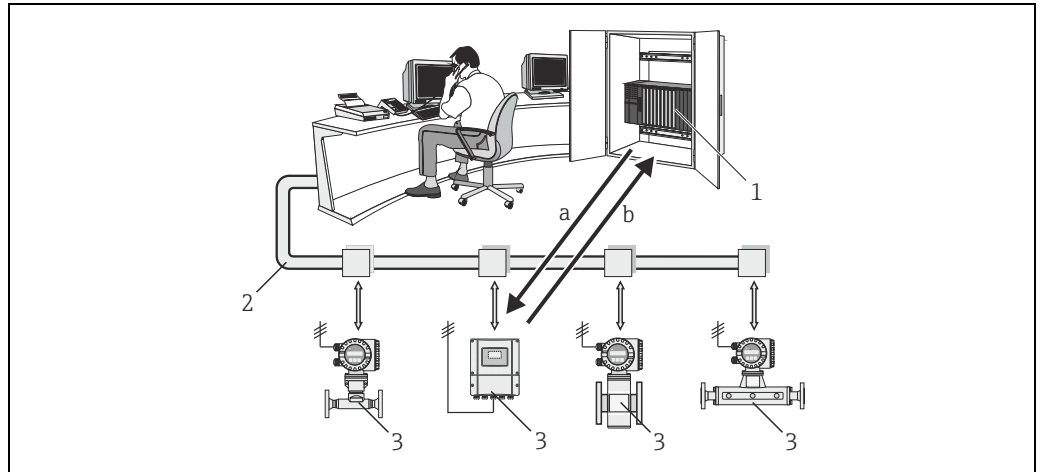

Fig. 11: Modbus RS485 polling data traffic

- 1 Modbus master (PLC etc.)
- 2 Modbus RS485
- 3 Modbus slave (measuring devices etc.)
- a Request telegram to this one specific Modbus slave
- b Response telegram to the Modbus master

■ **Broadcast message**

By means of the global address 0 (broadcast address), the master sends a command to all the slaves in the fieldbus system. The slaves execute the command without reporting back to the master. Broadcast messages are only permitted in conjunction with write function codes.

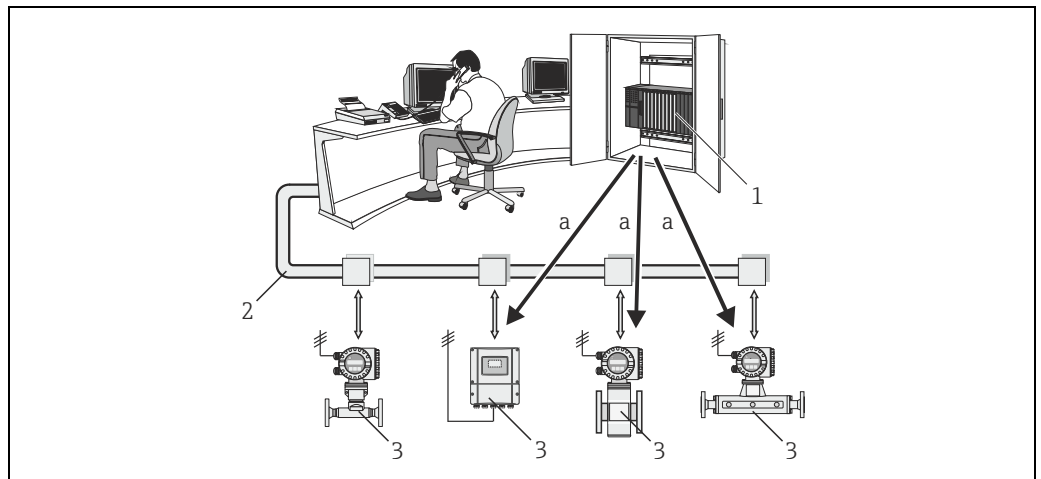

Fig. 12: Modbus RS485 polling data traffic

- 1 Modbus master (PLC etc.)
- 2 Modbus RS485
- 3 Modbus slave (measuring devices etc.)
- a Broadcast message - command to all Modbus slaves (request is executed without a response telegram to the master)

6.2.2 Modbus telegram

General

The master-slave process is used for data exchange. Only the master can initiate data transmission. Following the prompt, the slave sends the master the necessary data as a response telegram or executes the command requested by the master.

Telegram structure

The data is transferred between the master and slave by means of a telegram. A request telegram from the master contains the following telegram fields:

Telegram structure:

Slave address	Function code	Data	Check sum
---------------	---------------	------	-----------

- Slave address
 - The slave address can be in an address range from 1 to 247.
 - The master talks to all the slaves simultaneously by means of the slave address 0 (broadcast message).
- Function code
 - The function code determines which read, write and test operations should be executed by means of the Modbus protocol.
 - Function codes supported by the measuring device →  21
- Data
 - Depending on the function code, the following values are transmitted in this data field:
 - Register start address (from which the data are transmitted)
 - Number of registers
 - Write/read data
 - Data length
 - etc.
- Check sum (CRC or LRC check)
 - The telegram check sum forms the end of the telegram.

The master can send another telegram to the slave as soon as it has received an answer to the previous telegram or once the time-out period set at the master has expired. This time-out period can be specified or modified by the user and depends on the slave response time.

If an error occurs during data transfer or if the slave cannot execute the command from the master, the slave returns an error telegram (exception response) to the master.

The slave response telegram consists of telegram fields which contain the requested data or which confirm that the action requested by the master has been executed. It also contains a check sum.

6.2.3 Modbus function codes

The function code determines which read, write and test operations should be executed by means of the Modbus protocol. The measuring device supports the following function codes:

Function code	Name in accordance with Modbus specification	Description
03	READ HOLDING REGISTER	Reads one or more registers of the Modbus slave. 1 to a maximum of 125 consecutive registers (1 register = 2 byte) can be read with a telegram. Application: For reading measuring device parameters with read and write access, such as reading the batch quantity.
04	READ INPUT REGISTER	Reads one or more registers of the Modbus slave. 1 to a maximum of 125 consecutive registers (1 register = 2 byte) can be read with a telegram. Application: For reading measuring device parameters with read access, such as reading the measured values (mass flow, temperature etc.).
06	WRITE SINGLE REGISTERS	Writes a single slave register with a new value. Application: For writing just one measuring device parameter, such as writing the batch quantity or resetting the totalizer.  Note! Function code 16 is used for writing several registers by means of just one telegram.
08	DIAGNOSTICS	Checks the communication connection between the master and slave. The following diagnostics codes are supported: <ul style="list-style-type: none"> ▪ Sub-function 00 = Return query data (loopback test) ▪ Sub-function 02 = Return diagnostics register
16	WRITE MULTIPLE REGISTERS	Writes several slave registers with a new value. A maximum of 120 consecutive registers can be written with a telegram. Application: For writing several measuring device parameters, such as writing the batch quantity and resetting the totalizer.
23	READ/WRITE MULTIPLE REGISTERS	Simultaneous reading and writing of 1 to max. 118 registers in a telegram. Write access is executed before read access. Application: For writing and reading several measuring device parameters, such as writing the batch quantity and the correction quantity and reading the totalizer value.



Note!

- Broadcast messages are only permitted with function codes 06, 16 and 23.
- The measuring device does not differentiate between function codes 03 and 04. These codes have the same result.

6.2.4 Maximum number of writes

If a nonvolatile device parameter is modified via the Modbus function codes 06, 16 or 23, this change is saved in the EEPROM of the measuring device. The number of writes to the EEPROM is technically restricted to a maximum of 1 million. Attention must be paid to this limit since, if exceeded, it results in data loss and measuring device failure. For this reason, avoid constantly writing nonvolatile device parameters via the Modbus.

6.2.5 Modbus register addresses

Each device parameter has its own register address. The Modbus master uses this register address to talk to the individual device parameters and access the device data. The register addresses of the individual device parameters can be found in Chapter 12 "Appendix – Device Functions" (→ 53), under the parameter description in question.

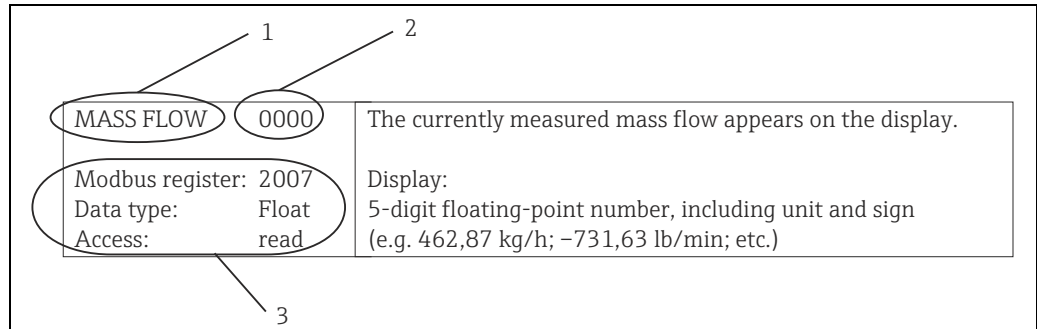

Fig. 13: Example of how a function description is illustrated in the "Description of Device Parameters" manual

- 1 Name of the function
- 2 Number of the function (appears on the local display; is **not** identical to the Modbus register address)
- 3 Information on communication via Modbus RS485
 - Modbus register (information in decimal numerical format)
 - Data type: Float, Integer or String
 - Possible ways of accessing the function:
 - read = read access via function codes 03, 04 or 23
 - write = write access via function codes 06, 16 or 23

Modbus register address model

The Modbus RS485 register addresses of the measuring device are implemented in accordance with "Modbus Applications Protocol Specification V1.1".



Note!

In addition to the specification mentioned above, systems are also deployed which work with a register address model in accordance with the "Modicon Modbus Protocol Reference Guide (PI-MBUS-300 Rev. J)" specification. With this specification, the register address is extended, depending on the function code used. A "3" is put in front of the register address in the "read" access mode and a "4" in the "write" access mode.

Function code	Access type	Register in accordance with: "Modbus Applications Protocol Specification"		Register in accordance with: "Modicon Modbus Protocol Reference Guide"
03 04 23	Read	XXXX Example: mass flow = 2007	→	3XXXX Example: mass flow = 32007
06 16 23	Write	XXXX Example: reset totalizer = 6401	→	4XXXX Example: reset totalizer = 46401

Response times

The time it takes a measuring device to respond to a request telegram from the Modbus master is typically 25 to 50 ms. If faster response times are needed for time-critical applications (e.g. batching applications), the "auto-scan buffer" is to be used.



Note!

It may take longer for a command to be executed in the device. The data is not updated until the command has been executed. Especially write commands are affected by this.

Data types

The following data types are supported by the measuring device:

- **FLOAT** (floating-point numbers IEEE 754)
Data length = 4 bytes (2 registers)

Byte 3	Byte 2	Byte 1	Byte 0
SEEEEEEE	EMMMMMMM	MMMMMMMM	MMMMMMMM

S = sign
E = exponent
M = mantissa

- **INTEGER**
Data length = 2 bytes (1 register)

Byte 1	Byte 0
Most significant byte (MSB)	Least significant byte (LSB)

- **STRING**
Data length = depends on device parameter,
e.g. illustration of a device parameter with a data length = 18 bytes (9 registers):

Byte 17	Byte 16	to	Byte 1	Byte 0
Most significant byte (MSB)		to		Least significant byte (LSB)

Byte transmission sequence

Byte addressing, i.e. the transmission sequence of the bytes, is not specified in the Modbus specification. For this reason, it is important to coordinate the addressing method between the master and slave during commissioning. This can be configured in the measuring device by means of the "BYTE ORDER" parameter (→ 79).

The bytes are transmitted depending on the option selected in the "BYTE ORDER" parameter:

FLOAT:

Selection	Sequence			
	1st	2nd	3rd	4th
1 - 0 - 3 - 2 *	Byte 1 (MMMMMMMM)	Byte 0 (MMMMMMMM)	Byte 3 (SEEEEEEE)	Byte 2 (EMMMMMMM)
0 - 1 - 2 - 3	Byte 0 (MMMMMMMM)	Byte 1 (MMMMMMMM)	Byte 2 (EMMMMMMM)	Byte 3 (SEEEEEEE)
2 - 3 - 0 - 1	Byte 2 (EMMMMMMM)	Byte 3 (SEEEEEEE)	Byte 0 (MMMMMMMM)	Byte 1 (MMMMMMMM)
3 - 2 - 1 - 0	Byte 3 (SEEEEEEE)	Byte 2 (EMMMMMMM)	Byte 1 (MMMMMMMM)	Byte 0 (MMMMMMMM)

* = Factory setting
S = sign
E = exponent
M = mantissa

INTEGER:

Selection	Sequence	
	1st	2nd
1 - 0 - 3 - 2 * 3 - 2 - 1 - 0	Byte 1 (MSB)	Byte 0 (LSB)
0 - 1 - 2 - 3 2 - 3 - 0 - 1	Byte 0 (LSB)	Byte 1 (MSB)

* = Factory setting
 MSB = most significant byte
 LSB = least significant byte

STRING:

Illustration using the example of a device parameter with a data length of 18 bytes.

Selection	Sequence				
	1st	2nd	to	17th	18th
1 - 0 - 3 - 2 * 3 - 2 - 1 - 0	Byte 1	Byte 0 (LSB)	to	Byte 17 (MSB)	Byte 16
0 - 1 - 2 - 3 2 - 3 - 0 - 1	Byte 0 (LSB)	Byte 1	to	Byte 16	Byte 17 (MSB)

* = Factory setting
 MSB = most significant byte
 LSB = least significant byte

6.2.6 Modbus error messages

If the Modbus slave detects an error in the request telegram from the master, it sends a reply to the master in the form of an error message consisting of the slave address, function code, exception code and check sum. To indicate that this is an error message, the lead bit of the returned function code is used. The reason for the error is transmitted to the master by means of the exception code.

The following exception codes are supported by the measuring device:

Exception codes	Description
01	ILLEGAL_FUNCTION The function code sent by the master is not supported by the measuring device (slave).  Note! Description of the function codes supported by the measuring device → 21.
02	ILLEGAL_DATA_ADDRESS The register addressed by the master is not assigned (i.e. it does not exist) or the length of the requested data is too big.
03	ILLEGAL_DATA_VALUE <ul style="list-style-type: none"> ▪ The master is attempting to write to a register which only allows read access. ▪ The value that appears in the data field is not permitted: e.g. range limits overshoot or incorrect data format.
04	SLAVE_DEVICE_FAILURE The slave did not respond to the request telegram from the master or an error occurred when processing the request telegram.

6.2.7 Modbus auto-scan buffer

Function description

The Modbus master uses the request telegram to access the device parameters (data) of the measuring device. Depending on the function code, the master gains read or write access to a single device parameter or a group of consecutive device parameters. If the desired device parameters (registers) are not available as a group, the master has to send a request telegram to the slave for each parameter.

The measuring device has a special storage area, known as the auto-scan buffer, for grouping nonconsecutive device parameters. This can be used to flexibly group up to 16 device parameters (registers). The master can talk to this complete data block by means of just one request telegram.

Structure of the auto-scan buffer

The auto-scan buffer consists of two data records, the configuration area and the data area. In the configuration area, a list known as the scan list specifies which device parameters should be grouped. For this purpose, the corresponding register address, e.g. the register address 2007 for mass flow, is entered in the scan list. Up to 16 device parameters can be grouped.

The measuring device cyclically reads out the register addresses entered in the scan list and writes the associated device data to the data area (buffer). The request cycle runs automatically. The cycle starts again when the last entry in the scan list has been queried. By means of Modbus, the grouped device parameters in the data area can be read or written by the master with just one request telegram (register address 5051 to 5081).

Configuration of the scan list

During configuration, the Modbus register addresses of the device parameters to be grouped must be entered in the scan list. The scan list can contain up to 16 entries. Float and Integer-type device parameters with read and write access are supported.

The scan list can be configured by means of:

1. The local display or a configuration program (FieldCare).
The scan list is configured here by means of the function matrix:
BASIC FUNCTION → Modbus RS485 → SCAN LIST REG. 1 to SCAN LIST REG. 16
2. The Modbus master.
Here, the scan list is configured via the register addresses 5001 to 5016.

Scan list		
No.	Modbus configuration Register address (data type = Integer)	Configuration via local operation / configuration program (BASIC FUNCTION → Modbus RS485 →)
1	5001	SCAN LIST REG. 1
2	5002	SCAN LIST REG. 2
3	5003	SCAN LIST REG. 3
4	5004	SCAN LIST REG. 4
5	5005	SCAN LIST REG. 5
6	5006	SCAN LIST REG. 6
7	5007	SCAN LIST REG. 7
8	5008	SCAN LIST REG. 8
9	5009	SCAN LIST REG. 9
10	5010	SCAN LIST REG. 10
11	5011	SCAN LIST REG. 11

Scan list		
No.	Modbus configuration Register address (data type = Integer)	Configuration via local operation / configuration program (BASIC FUNCTION → Modbus RS485 →)
12	5012	SCAN LIST REG. 12
13	5013	SCAN LIST REG. 13
14	5014	SCAN LIST REG. 14
15	5015	SCAN LIST REG. 15
16	5016	SCAN LIST REG. 16

Access to data via Modbus

The Modbus master uses the register addresses 5051 to 5081 to access the data area of the auto-scan buffer. This data area contains the values of the device parameters defined in the scan list. For example, if the register 2007 was entered for mass flow in the scan list by means of the SCAN LIST REG. 1 function, the master can read out the current measured value of the mass flow in register 5051.

Parameter value/Measured values		Data area		
		Access via Modbus register address	Data type *	Access**
Value of scan list entry No. 1	→	5051	Integer / Float	Read/Write
Value of scan list entry No. 2	→	5053	Integer / Float	Read/Write
Value of scan list entry No. 3	→	5055	Integer / Float	Read/Write
Value of scan list entry No. 4	→	5057	Integer / Float	Read/Write
Value of scan list entry No. 5	→	5059	Integer / Float	Read/Write
Value of scan list entry No. 6	→	5061	Integer / Float	Read/Write
Value of scan list entry No. 7	→	5063	Integer / Float	Read/Write
Value of scan list entry No. 8	→	5065	Integer / Float	Read/Write
Value of scan list entry No. 9	→	5067	Integer / Float	Read/Write
Value of scan list entry No. 10	→	5069	Integer / Float	Read/Write
Value of scan list entry No. 11	→	5071	Integer / Float	Read/Write
Value of scan list entry No. 12	→	5073	Integer / Float	Read/Write
Value of scan list entry No. 13	→	5075	Integer / Float	Read/Write
Value of scan list entry No. 14	→	5077	Integer / Float	Read/Write
Value of scan list entry No. 15	→	5079	Integer / Float	Read/Write
Value of scan list entry No. 16	→	5081	Integer / Float	Read/Write
* The data type depends on the device parameter entered in the scan list				
** The data access depends on the device parameter entered in the scan list. If the device parameter entered supports read and write access, the parameter can also be accessed by means of the data area.				

Response time

The response time when accessing the data area (register addresses 5051 to 5081) is typically between 3 and 5 ms.



Note!

It may take longer for a command to be executed in the device. The data is not updated until the command has been executed. Especially write commands are affected by this.

Example

The following device parameters should be grouped via the auto-scan buffer and read out by the master with just one request telegram:

- Mass flow → Register address 2007
- Temperature → Register address 2017
- Totalizer 1 → Register address 2610
- Actual system condition → Register address 6859

1. Configuration of the scan list

- With the local operation or a configuration program (via the function matrix):
 BASIC FUNCTION block → Modbus RS485 function group → SCAN LIST REG. function
 → Entry of the address 2007 under SCAN LIST REG. 1
 → Entry of the address 2017 under SCAN LIST REG. 2
 → Entry of the address 2610 under SCAN LIST REG. 3
 → Entry of the address 6859 under SCAN LIST REG. 4
- Via the Modbus master (the register addresses of the device parameters are written to the registers 5001 to 5004 via Modbus):
 1. Write address 2007 (mass flow) to register 5001
 2. Write address 2017 (temperature) to register 5002
 3. Write address 2610 (totalizer 1) to register 5003
 4. Write address 6859 (actual system condition) to register 5004

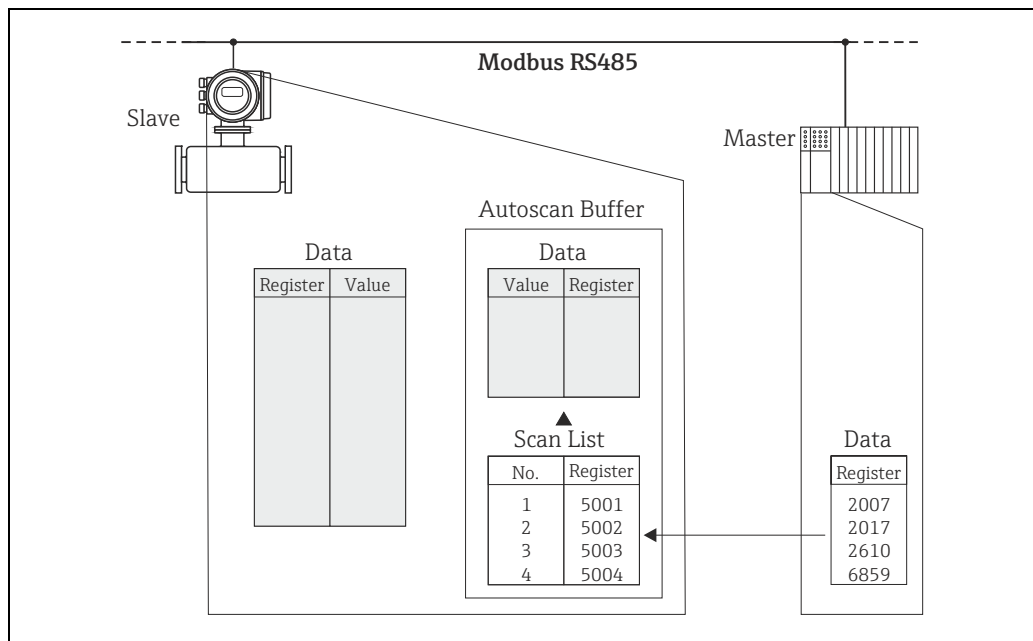

Fig. 14: Configuration of the scan list via the Modbus master

2. Access to data via Modbus

By specifying the register start address 5051 and the number of registers, the Modbus master can read out the measured values with just one request telegram.

Data area			
Access via Modbus register address	Measuring values	Data type	Access
5051	Mass flow = 4567.67	Float	Read
5053	Temperature = 26.5	Float	Read
5055	Totalizer 1 = 56345.6	Float	Read
5057	Actual system condition = 1 (system ok)	Integer	Read

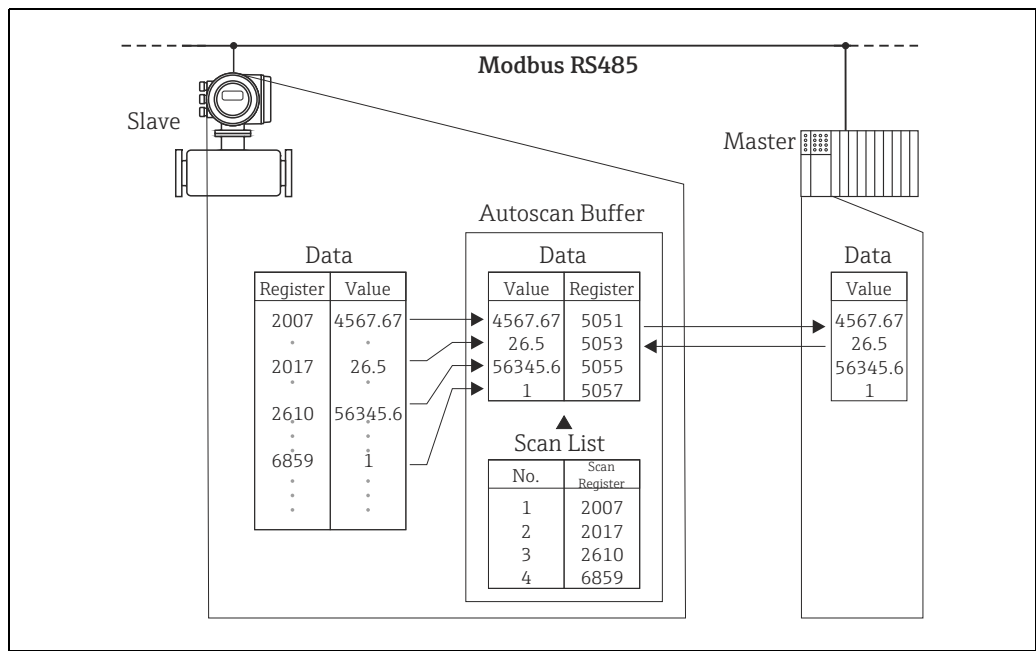

Fig. 15: With just one request telegram, the Modbus master reads out the measured values via the auto-scan buffer of the measuring device.

6.2.8 Integer scaling of the measured variables

The current measured variables such as mass flow, density, temperature etc. are usually represented on the side of the Modbus Slaves as floating point numbers after IEEE 754 (single Precision 32 bits). Thus the value of a measured variable occupies in each case two Modbus registers with in each case 16 bits. In order to save storage location on the side of the Modbus Masters and/or time during the data communication, the possibility insists of making on the side of the Modbus Slaves an integer scaling of the measured variables on 16 bits. Then the scaled value occupies only one Modbus register.

In addition for each measured variable a scaling factor K and a scaling offset OS (→ 82 et sqq.) is given, which are in each case integer values. The appropriate measured variable X is then scaled as follows on Y (→ 81).

$$Y = \text{INT}((X \cdot K) + (32768 - OS))$$

The function INT means that the decimal point portion of the event in the brackets is **cut off** and is not rounded. If the result Y of the scaling is smaller 0 or larger than the as the largest possible value defined value Y_{\max} (→ 82), $Y_{\max} + 1$ is transferred.

Example:

Current mass flow X	1.2545 kg/min
Mass flow factor K	100
Mass flow offset OS	32768
Integer scaled mass flow Y	$Y = \text{INT}((1.2545 \cdot 100) + (32768 - 32768)) = \text{INT}(125.45 + 0) = 125$

Current mass flow X	- 1.2545 kg/min
Mass flow factor K	100
Mass flow offset OS	0
Integer scaled mass flow Y	$Y = \text{INT}((-1.2545 \cdot 100) + (32768 - 0)) = \text{INT}(-125.45 + 32768) = \text{INT}(32642.55) = 327642$

6.2.9 Configuring the device address

The valid device addresses are in the range from 1 to 247. In a Modbus RS485 network, each address can only be assigned once. If an address is not configured correctly, the device is not recognized by the Modbus master. All measuring devices are delivered from the factory with the default device address 247. Configuring the device address → 78.

6.3 Operating options

6.3.1 Operating program "FieldCare"

FieldCare is Endress+Hauser's FDT-based plant asset management tool and allows the configuration and diagnosis of intelligent field devices. By using status information, you also have a simple but effective tool for monitoring devices. The flowmeters are accessed via a service interface or via the service interface FXA291.

6.3.2 Device description files for operating programs

Operation:

Operating program/Device driver:	How to acquire:
FieldCare/ DTM	<ul style="list-style-type: none">▪ www.endress.com (→ Download → Software → Driver)▪ CD-ROM (Endress+Hauser order number: 56004088)

7 Commissioning

7.1 Function check

Make sure that all the final checks have been completed before commissioning the measuring point:

- Checklist for "Post-installation check" → 11.
- Checklist for "Post-connection check" → 16.

7.2 Switching on the measuring device

Once the installation checks have been successfully completed, it is time to switch on the supply voltage. The device is now operational.

The measuring device performs a number of power on self-tests. Normal measuring mode commences as soon as startup completes.



Note!

If the startup is not successful, depending on the cause, a corresponding message is displayed in the Fieldtool operating program, or the status LED flashes correspondingly (→ 39).

7.3 Zero point adjustment

All measuring devices are calibrated with state-of-the-art technology. Calibration takes place under reference operating conditions → 48. Consequently zero point adjustment is generally **not** necessary.

Experience shows that the zero point adjustment is advisable only in special cases:

- To achieve highest measuring accuracy also with very small flow rates.
- Under extreme process or operating conditions (e.g. very high process temperatures).

7.3.1 Preconditions for a zero point adjustment

Note the following before you perform a zero point adjustment:

- Adjustment can only be performed on homogeneous fluids.
- Zero point adjustment is performed at zero flow ($v = 0 \text{ m/s}$). This can be achieved, for example, with shutoff valves upstream and/or downstream of the sensor or by using existing valves and gates.
 - Normal operation → valves 1 and 2 open
 - Zero point adjustment **with** pump pressure → Valve 1 open / valve 2 closed
 - Zero point adjustment **without** pump pressure → Valve 1 closed / valve 2 open

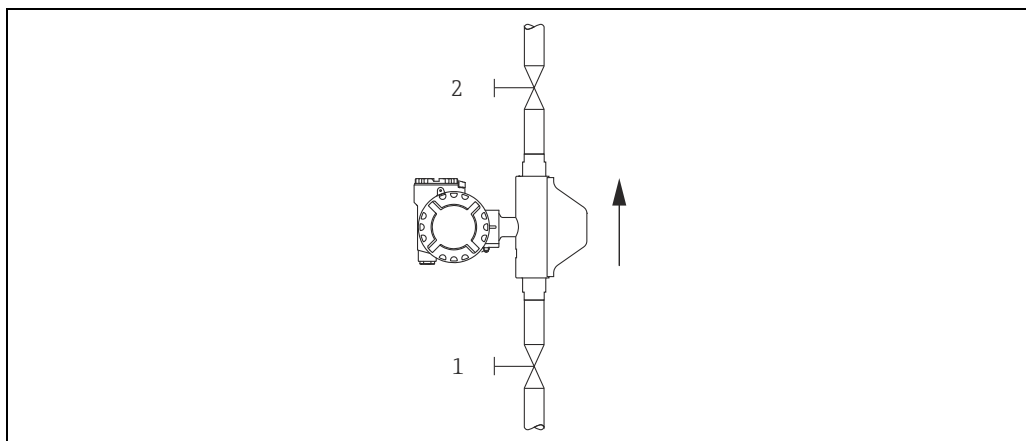



Fig. 16: Zero point adjustment and shutoff valves (1 + 2)

A0006928

**Caution!**

- The currently valid zero point value can be viewed using the "ZEROPOINT" function (→  88).

7.3.2 Performing a zero point adjustment

1. Operate the system until operating conditions have settled.
2. Stop the flow ($v = 0$ m/s).
3. Check the shutoff valves for leaks.
4. Check that operating pressure is correct.
5. Carry out the alignment using the "ZEROPOINT ADJUST" (→  88).

7.4 Memory (HistoROM)

At Endress+Hauser, the term HistoROM refers to various types of data storage modules on which process and measuring device data are stored. By unplugging and plugging such modules, device configurations can be duplicated onto other measuring devices, to cite just one example.

7.4.1 HistoROM/S-DAT (sensor-DAT)

The S-DAT is a data storage device in which all sensor relevant parameters are stored, i.e., diameter, serial number, calibration factor, zero point.

8 Custody transfer measurement

CNGmass is a flowmeter for Compressed Natural Gas (CNG) that is suitable for custody transfer measurement.

8.1 Suitability for custody transfer measurement, approval by the Standards Authorities, repeated calibration due to legal metrology controls

All flowmeters are typically verified on site using reference measurements. Only once it has been approved by the authority for legal metrology controls may the measuring device be regarded as verified and used for applications subject to legal metrology controls. The associated seal on the measuring device ensures this status.



Caution!

- Only flowmeters verified by the Standards Authorities may be used for invoicing in applications subject to legal metrology controls.
- The owner-operator of a verified measuring system is obliged to carry out repeat calibration on the unit in accordance with the regulations of the authority for legal metrology controls.

8.1.1 Approval for custody transfer

The following guidelines for the custody transfer process were developed in accordance with the following authorities for legal metrology controls:

- | | | | |
|---------------|-------------|--------|---------|
| ▪ PTB | Germany | ▪ BEV | Austria |
| ▪ NMI | Netherlands | ▪ NTEP | USA |
| ▪ METAS | Switzerland | ▪ MC | Canada |
| ▪ Rosstandart | Russia | | |

8.1.2 Verification process

The verification process is regulated by national rules or regulations.

8.1.3 Setting up custody transfer mode

The flowmeter must be locked for custody transfer measurement (in this status, no parameters can be changed, i.e. all settings must have been configured first according to the application. An exception is the totalizer 3, whose parameter remains writable also in the custody transfer mode, i.e. it can be reset also in the custody transfer mode). For this purpose, the switch **1** is moved to the position shown below (1). You receive confirmation from the status LED (→ 39). Then, fit the cover and have the safety claw sealed by a person authorized to do so (2).

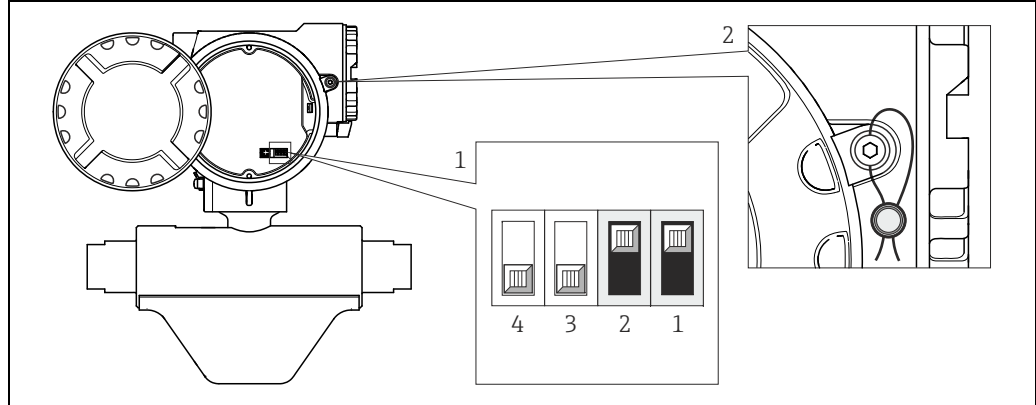

Fig. 17: Switch locked

8.1.4 Disabling custody transfer mode

The flowmeter can be reset to exit custody transfer mode.

To do so, destroy and remove the seal on the safety claw (1). This process may be carried out by authorized personnel only. Open the cover. Return switch **1** to the position shown below (2). You receive confirmation from the status LED (→ 39).

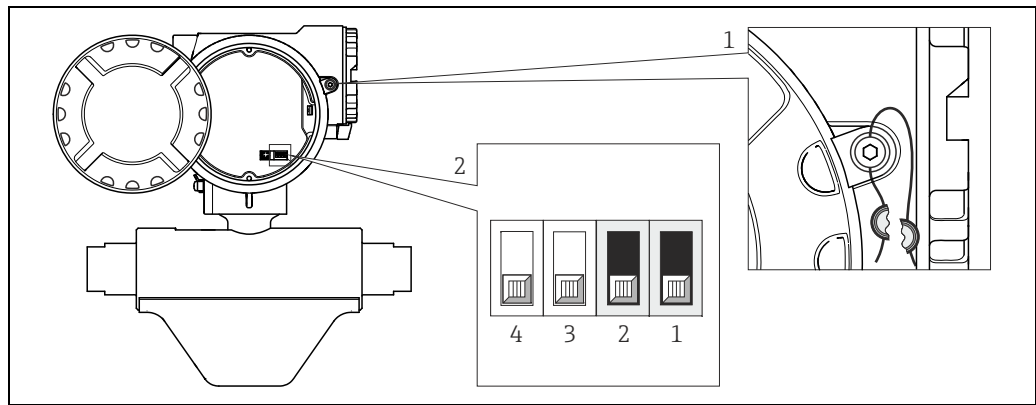

Fig. 18: Switch unlocked

9 Maintenance

No special maintenance work is required.

9.1 External cleaning

When cleaning the exterior of measuring devices, always use cleaning agents that do not attack the surface of the housing and the seals.

10 Accessories

Various accessories, which can be ordered with the device or subsequently from Endress+Hauser, are available for the device. Detailed information on the order code in question is available from your local Endress+Hauser sales center or on the product page of the Endress+Hauser website: www.endress.com.

10.1 Device-specific accessories

10.1.1 For the Transmitter

Accessories	Description
Electronics module	Complete plug-in electronics module.

10.2 Service-specific accessories

Accessories	Description
Applicator	<p>Software for selecting and sizing Endress+Hauser measuring devices:</p> <ul style="list-style-type: none"> ■ Calculation of all the necessary data for identifying the optimum flowmeter: e.g. nominal diameter, pressure loss, accuracy or process connections ■ Graphic illustration of the calculation results <p>Administration, documentation and access to all project-related data and parameters over the entire life cycle of a project.</p> <p>Applicator is available:</p> <ul style="list-style-type: none"> ■ Via the Internet: https://wapps.endress.com/applicator ■ On CD-ROM for local PC installation
W@M	<p>Life cycle management for your plant.</p> <p>W@M supports you with a wide range of software applications over the entire process: from planning and procurement, to the installation, commissioning and operation of the measuring devices. All the relevant device information, such as the device status, spare parts and device-specific documentation, is available for every device over the entire life cycle. The application already contains the data of your Endress+Hauser device. Endress+Hauser also takes care of maintaining and updating the data records.</p> <p>W@M is available:</p> <ul style="list-style-type: none"> ■ Via the Internet: www.endress.com/lifecyclemanagement ■ On CD-ROM for local PC installation
FieldCare	<p>FieldCare is Endress+Hauser's FDT-based plant asset management tool and allows the configuration and diagnosis of intelligent field devices. By using status information, you also have a simple but effective tool for monitoring devices. The Proline flowmeters are accessed via a service interface or via the service interface FXA193.</p>
FXA291	Service interface from the measuring device to the PC for operation via FieldCare.





10.3 System components

Accessories	Description
Memograph M graphic display recorder	The Memograph M graphic display recorder provides information on all the relevant process variables. Measured values are recorded correctly, limit values are monitored and measuring points analyzed. The data are stored in the 256 MB internal memory and also on a DSD card or USB stick. Memograph M boasts a modular design, intuitive operation and a comprehensive security concept. The ReadWin® 2000 PC software is part of the standard package and is used for configuring, visualizing and archiving the data captured. The mathematics channels which are optionally available enable continuous monitoring of specific power consumption, boiler efficiency and other parameters which are important for efficient energy management.

11 Troubleshooting

11.1 Self-monitoring

Exceptional states that arise during operation are detected by the flowmeter and corresponding messages are output:

- Via the outputs, depending on the setting (→  63, →  72)
- Via the Modbus interface, depending on the setting (→  24)
- Via error messages in the "FieldCare" operating program (→  40)
- Via the status LED (→  39, visible only when the device is open)

If multiple messages are pending, the one with the highest priority is output.

The message about a status can be assigned to a category as follows:

OFF

- When the status occurs, no message is generated

Error

- The message belongs to the "Errors" category, meaning that the measuring system cannot continue measuring operation.

Note

- The message belongs to the "Notes" category, meaning that the measuring system may be able to continue measuring operation with restrictions.

11.2 Diagnosis using light emitting diode (LED)

There is a Light Emitting Diode (LED) on the meter electronics board that allows simple fault diagnostics at any time:

- If the status output was not configured to output errors or notes.
- If fault diagnostics are no longer possible via the Fieldtool operating program.



Warning!

Risk of explosion. The electronics compartment may not be opened while there is an explosive atmosphere. This type of fault diagnostics can no longer be carried out in Ex-protected areas.

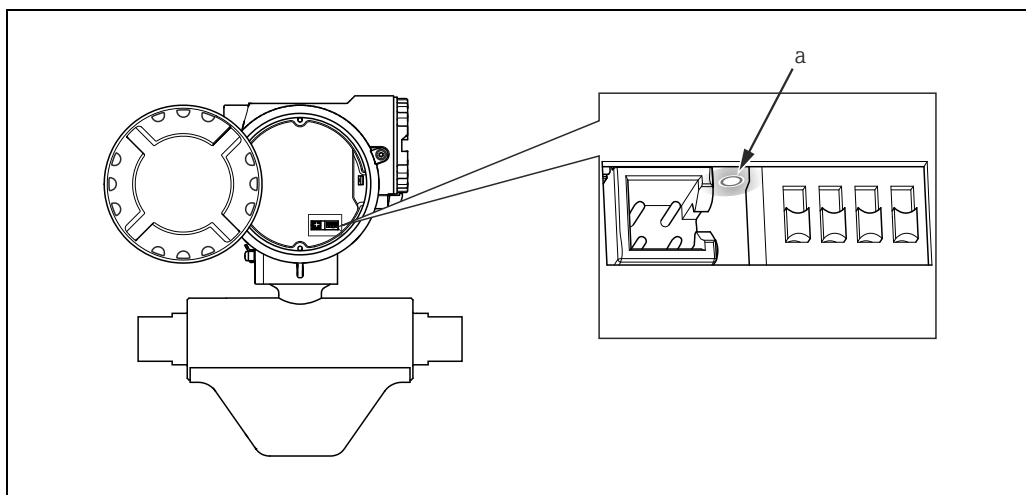

Fig. 19: Fault diagnostics using light emitting diode (a)

A0006980

Status of light emitting diode (LED)	Status of measuring system
LED illuminated in green	Measuring system OK, creepage is active
LED flashes green (once per second)	Measuring system OK, operation
LED not illuminated	Measuring system no longer working
LED flashes red (three times per second)	<ul style="list-style-type: none"> - Operation not possible - Error (fault message) pending
LED flashes red/green (once per second)	<ul style="list-style-type: none"> - Operation possible, but may be limited by application conditions. - Notice message pending
LED flashes red/green (three times per second)	Zero point adjustment running
LED flashes green/orange (approx. 3 seconds long)	Custody transfer mode started
LED flashes red/orange (approx. 3 seconds long)	Custody transfer mode exited
LED flashes red/(pause)/green (approx. 3 seconds long)	SW update active

11.3 Messages (FieldCare)

No. / error message	Cause	Remedy / spare part
# 001 CRITICAL FAIL		Replace the electronics module (→ 44). Spare parts: → 42
# 002 CONFIGURATION FAILURE	Inconsistent parameter configuration	Restore the factory settings.
# 011 AMP HW-EEPROM	Electronics module: Defective EEPROM	Replace the electronics module (→ 44). Spare parts: → 42
# 012 AMP SW-EEPROM	Electronics module: Error when accessing the EEPROM	Restore the factory settings.
# 021 HW-FRAM	Electronics module: Faulty FRAM	Replace the electronics module (→ 44). Spare parts: → 42
# 022 SW-FRAM	Electronics module: Error when accessing the FRAM	Contact your E+H service organization.
# 031 HW-DAT	Sensor DAT: 1. DAT is defective. 2. DAT is not plugged in or is missing.	1. Replace DAT. Spare parts: → 42 Check the spare part set number to ensure that the new, replacement DAT is compatible with the meter electronics. 2. Insert the DAT: → 44
# 032 SW DAT	Sensor: Error when accessing the DAT.	Restore the factory settings.
# 101 STARTUP RUNNING	Measuring instrument is running though the startup procedure.	–
# 355/356 RANGE FRQ.OUT 1/2	Frequency output: The output frequency is out of range.	1. Increase the entered full scale value 2. Reduce flow rate
# 359/360 RANGE PULSE 1/2	Pulse output: Pulse output frequency is out of range.	1. Increase the setting for pulse weighting. 2. Reduce flow rate.
# 379 LOW FREQ.LIM.	The measuring tube oscillation frequency is below the permitted range. Causes: – Measuring tube damaged – Sensor defective or damaged	Contact your E+H service organization.
# 380 UPP.FREQ.LIM.	The measuring tube oscillation frequency is above the permitted range. Causes: – Measuring tube damaged – Sensor defective or damaged	Contact your E+H service organization.
# 381 MEAS. TEMP. CIRC. SHORT	The temperature sensor on the measuring tube is likely defective.	Check whether the connector of the sensor signal cable is correctly plugged into the electronics module before contacting your E+H service organization (→ 44).
# 382 MEAS. TEMP. CIRC. OPEN		
# 383 CARR. TEMP. CIRC. SHORT	The temperature sensor on the carrier tube is likely defective.	Check whether the connector of the sensor signal cable is correctly plugged into the electronics module before contacting your E+H service organization (→ 44).
# 384 CARR. TEMP. CIRC. OPEN		
# 387 SEN.ASY.EXCEED	One of the sensor coils (on the inlet or outlet side) is probably defective.	Check whether the connector of the sensor signal cable is correctly plugged into the electronics module before contacting your E+H service organization (→ 44).
# 388 ZP-COMP. INSTABILE	External process conditions	Contact your E+H service organization.

No. / error message	Cause	Remedy / spare part
# 389 ZP-COMP. LIMIT	-	Contact your E+H service organization.
# 390 COMMUNIC.DSP	-	Replace the electronics module.
# 586 OSC.AMP.LIM	The fluid properties do not allow a continuation of the measurement.	Change or improve process conditions.
# 587 TUBE NOT OSC.	Extreme process conditions exist. The measuring system can therefore not be started. The measuring cell or electronics are defective.	Change or improve process conditions. Replace the electronics module (→ 44). Spare parts: → 42
# 692 SIM. MEASURAND	Simulation of measuring variables (e.g. mass flow)	Switch off simulation
# 700 EMPTY PIPE	The density is below the lower limit value defined for the function "EPD VALUE LOW"	Adapt the "EPD" to the prevailing process conditions.
# 701 EXC.CURR.LIM	The maximum current value for the measuring tube excitation coil has been reached. The instrument continues to work correctly.	This could be caused by liquids contained in the fluid. Change or improve process conditions.
# 702 FLUID INHOM.	The frequency control is not stable because the fluid properties are inhomogenous.	This could be caused by liquids contained in the fluid. Change or improve process conditions.
# 703 FLUID INHOM.	The amplitude control is not stable due to inhomogenous fluid properties.	This could be caused by liquids contained in the fluid. Change or improve process conditions.
# 704 NOISE LIMIT	The failsafe level of the sensor signal is too high.	This could be caused by liquids contained in the fluid. Change or improve process conditions.
# 731 ADJ.ZERO FAIL.	The zero point adjustment is not possible.	Make sure that zero point adjustment is carried out at "zero flow" only ($v = 0 \text{ m/s}$) (→ 31).
# 740 ZEROPOINT ADJ. RUNNING	The zero point adjustment is running.	Wait until the zero point adjustment is finished.
# 801 LOW. PROC. LIMIT TEMP	The temperature has fallen below the lower process limit.	Change the process condition or setting (→ 94).
# 802 UPP. PROC. LIMIT TEMP	The temperature has exceeded the process limit.	Change the process condition or setting (→ 94).
# 803 LOW. PROC. LIMIT DENS.	The density has fallen below the lower process limit.	Change the process condition or setting (→ 94).
# 804 UPP. PROC. LIMIT DENS.	The density has exceeded the upper process limit.	Change the process condition or setting (→ 94).
# 805 LOW. PROC. LIMIT MASSFLOW	The mass flow has fallen below the lower process limit.	Change the process condition or setting (→ 94).
# 806 UPP. PROC. LIMIT MASSFLOW	The mass flow has exceeded the upper process limit.	Change the process condition or setting (→ 94).
# 807 LOW. PROC. LIMIT VOLFLOW	The volume flow has fallen below the lower process limit.	Change the process condition or setting (→ 94).
# 808 UPP. PROC. LIMIT VOLFLOW	The volume flow has exceeded the upper process limit.	Change the process condition or setting (→ 94).
# 809 SECURITY ACTIVATED	Custody transfer mode started. The corresponding DIP switches were actuated, → 34.	-
# 810 SECURITY DEACTIVATED	Custody transfer mode exited. The corresponding DIP switches were actuated, → 34.	-

11.4 Errors without messages

Symptoms	Rectification
<p>The error cannot be eliminated or another error pattern is present. In these instances, please contact your Endress+Hauser service organization.</p>	<p>The following solutions are possible:</p> <p>Request the services of an Endress+Hauser service technician If you request the services of a service technician, please be ready with the following information:</p> <ul style="list-style-type: none"> - Brief error description - Nameplate data (→ 6): order code and serial number <p>Return the devices to Endress+Hauser Procedures must be carried out before you return a flowmeter to Endress+Hauser for repair or calibration → 5, → 45.</p> <p>Replace the transmitter electronics Electronics module defective → order spare parts → 42.</p>

11.5 Spare parts

The previous sections contain detailed troubleshooting instructions → 38. The measuring device, moreover, provides additional support in the form of continuous self-diagnosis and storage of error messages that arise. Fault rectification can entail replacing defective components with tested spare parts. For an overview of the spare parts that can be delivered → 36.













Note!

Spare parts can be ordered directly from your Endress+Hauser representative by providing the serial number printed on the transmitter's nameplate (→ 6).

Spare parts are shipped as sets comprising the following parts:

- Spare part
- Additional parts, small items (threaded fasteners etc.)
- Mounting instructions
- Packaging

11.6 Response of outputs to errors

Failsafe mode of the outputs	
Output	Failsafe mode
Frequency output	<p> Note! The failsafe mode of the frequency output can be configured in various ways (→  72):</p> <p>FALLBACK VALUE Signal output → 0 Hz</p> <p>HOLD VALUE Last valid value (preceding occurrence of the fault) is output.</p> <p>HIGH VALUE Signal output → maximum possible frequency</p>
Pulse output	<p> Note! The failsafe mode of the pulse output can be configured in various ways (→  75):</p> <p>FALLBACK VALUE Signal output → no pulses</p> <p>HOLD VALUE Last valid value (preceding occurrence of the fault) is output.</p> <p>HIGH VALUE Signal output → maximum possible pulse rate</p>
Status output	<p> Note! The assignment of the status of the output can be defined (→  77). In the event of fault, note or power supply failure → status output not conductive.</p>
Totalizer	<p> Note! The failsafe mode of the totalizer can be configured in various ways (→  63):</p> <p>STOP The totalizers are paused until the error is rectified.</p> <p>HOLD VALUE The totalizers continue to count the flow in accordance with the last valid flow value (before the error occurred).</p>
Modbus RS485	<p> Note! The failsafe mode of the Modbus RS485 output can be configured in various ways (→  80):</p> <p>STOP In the event of a fault, the value "NaN" (not a number) is transmitted instead of the current measured value.</p> <p>HOLD VALUE Last valid value (preceding occurrence of the fault) is output.</p>

11.7 Removing and installing the meter electronics



Warning!

- Risk of explosion. The electronics compartment may not be opened while there is an explosive atmosphere.
- Risk of damaging electronic components (ESD protection). Static electricity can damage electronic components or impair their operability.

1. Switch off power supply
2. Unscrew the hexagon socket head cap screw with the Allen screw (1) and dismount the electronics compartment cover (2).
3. Remove the securing screw (3) of the protective cover.
4. Push the side snap hooks (2× item 4) together and pull off the protective cover (5).
5. Unplug the cable connector from the electronics module:
 - Pull off the connector of the sensor signal cable (6) by pulling it forwards.
 - Pull off the connector for the power supply and signal outputs (7) by pulling them upwards.
6. Remove the HistROM/DAT connector (8).
7. Unscrew the Phillips screws (2× item 9) and pull out the electronics module (10).
8. Installation is the reverse of the removal procedure.



Caution!

Use only original Endress+Hauser parts.

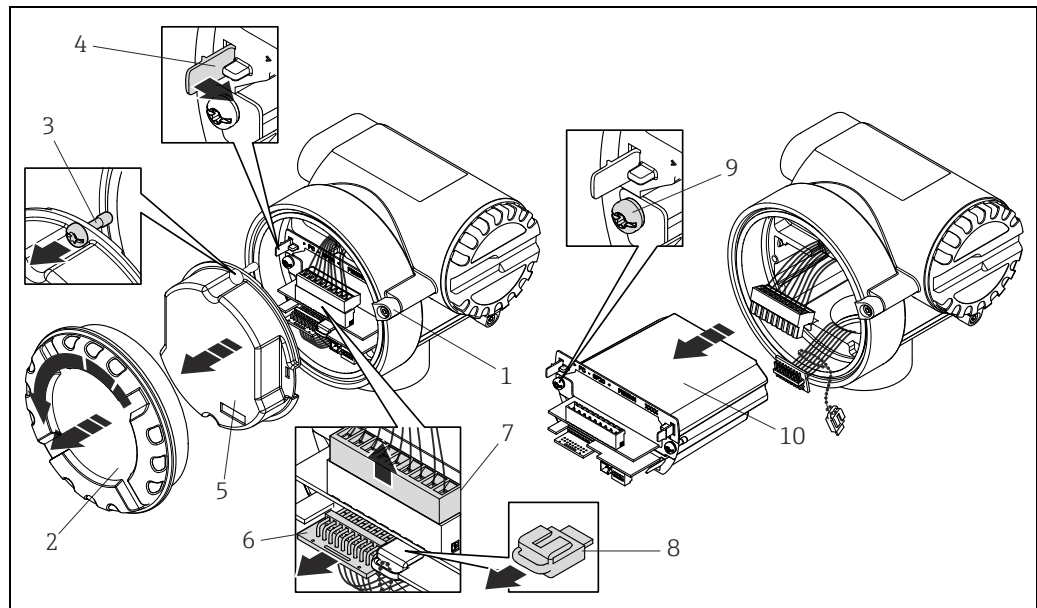

A0006933

Fig. 20: Removing and installing the meter electronics

- | | |
|----|-----------------------------------------------------|
| 1 | Allen screw |
| 2 | Electronics compartment cover |
| 3 | Securing screw of the protective cover |
| 4 | Snap hooks, 2× |
| 5 | Protective cover |
| 6 | Connector of the sensor signal cable |
| 7 | Cable connector for power supply and signal outputs |
| 8 | HistoROM/DAT connector |
| 9 | Phillips screw, 2× |
| 10 | Electronics module |

11.8 Return

The measuring device must be returned if repairs or a factory calibration are required, or if the wrong measuring device has been ordered or delivered. According to legal regulations, Endress+Hauser, as an ISO-certified company, is required to follow certain procedures when handling returned products that are in contact with medium.

To ensure swift, safe and professional device returns, please read the return procedures and conditions on the Endress+Hauser website at www.services.endress.com/return-material.

11.9 Disposal

Observe the regulations applicable in your country.

11.10 Software history

Date	Software version	Changes to software	Operating Instructions
03.2016	1.01.xx	--	71316750 / 14.16
11.2015	1.01.xx	--	71235481 / 13.15
08.2009	1.01.00	<ul style="list-style-type: none"> ▪ Alternative behavior Modbus interpreter ▪ Factory settings ▪ Integer scaled measured variables via Modbus 	71112142 / 04.10
12.2006	1.00.00	Original software	71035327 / 12.06

12 Technical data

12.1 Applications

The measuring system is used for mass flow measurement when fueling vehicles with CNG.

12.2 Function and system design

Measuring principle Mass flow measurement by the Coriolis principle

Measuring system The measuring system is a compact transmitter consisting of a sensor and a transmitter.

12.3 Input

Measured variable

- Mass flow (proportional to the phase difference between two sensors mounted on the measuring tube to register a phase shift in the oscillation)
- Volume flow (calculated using mass flow and density)
- Fluid density (proportional to the resonance frequency of the measuring tube)
- Fluid temperature (measured with temperature sensors)

Measuring range Measuring ranges for Compressed Natural Gas (CNG), non-custody transfer operation.

DN		$\dot{m}_{\min(F)}$ to $\dot{m}_{\max(F)}$	
[mm]	[in]	[kg/min]	[lb/min]
8	3/8"	0 to 30	0 to 66
15	1/2"	0 to 80	0 to 175
25	1"	0 to 150	0 to 330



Note!
The values of the corresponding custody transfer certificate apply for custody transfer operation.

Operable flow range 1 : 1000

12.4 Output

Output signal Pulse/frequency output

For custody transfer measurement, the two frequency/pulse outputs can be operated in redundant or phase-shifted mode.

- Passive
- Galvanically isolated
- Open Collector
- Max. 30 V DC
- Max. 25 mA
- Frequency output: end frequency 100 to 5000 Hz, on/off ratio 1:1, pulse width max. 2 s
- Pulse output: pulse value and pulse polarity selectable, pulse width configurable (0.1 to 1000 ms)

Status output

- Passive
- Open Collector
- Max. 30 V DC
- Max. 25 mA

Modbus RS485

- Modbus device type: slave
- Address range: 1 to 247
- Functions codes supported: 03, 04, 06, 08, 16, 23
- Broadcast: supported with the function codes 06, 16, 23
- Physical interface: RS485 in accordance with standard EIA/TIA-485
- Baudrate supported: 1200, 2400, 4800, 9600, 19200, 38400, 57600, 115200 Baud
- Transmission mode: RTU or ASCII
- Response time: typically 5 ms

Signal on alarm

Pulse/frequency output

De-energized in the event of fault or power supply failure

Status output

De-energized in the event of fault or power supply failure

Modbus RS485

De-energized in the event of fault or power supply failure

Load

→ "Output signal"

Galvanic isolation

All circuits for outputs, and power supply are galvanically isolated from each other.

12.5 Power supply

Terminal assignment

→  15

Supply voltage

24 V DC nominal voltage (10 to 30 V DC) / 24 V AC nominal voltage (20 to 28 V AC)

Power consumption

AC: < 4.0 VA
DC: < 3.2 W

Typical switch-on current at 24 V DC nominal voltage at $R_i = 0.1$ W of the source.

t [ms]	I [A]
0	10.0
0.1	8.0
0.2	7.5
0.5	7.0
1.0	6.0
2.0	4.0
5.0	1.5
10.0	0.125 (operating current)



Note!

The internal resistance of the source may not exceed $R_i = 10$ W.

Power supply failure Bridging of at least 20 ms.
All measuring cell and measuring point data are maintained.

Electrical connections →  14

Potential equalization This measuring device is suitable for potentially explosive atmospheres. Refer to the correspondingly information in the specific Ex-specific supplementary documentation.

Cable entries Power supply and signal cables (outputs):

- Cable entry M20 × 1.5 (8 to 12 mm / 0.31 to 0.47")
- Threads for cable entries, ½" NPT, G ½"

Cable specifications Each compatible cable, with a temperature specification at least 20 °C (68 °F) higher than the ambient temperature prevailing in the application. We recommend using a cable with a temperature specification of +80 °C (176 °F). Also refer to →  12.

12.6 Performance characteristics

Reference operating conditions Error limits following ISO/DIS 11631:

- Fluid: water
- 15 to 45 °C (59 to 113 °F); 2 to 6 bar (29 to 87 psi)
- Calibration rigs returned to national calibration standards
- Zero point calibrated under operating conditions
- Density adjustment carried out

To obtain measured errors, use the Applicator sizing tool *Applicator*: →  36.



Maximum measured error **Mass flow**
±0.5% of the quantity filled in typical CNG fueling.

Repeatability **Mass flow (gases)**
±0.25% of the quantity filled in typical CNG fueling.

Influence of medium temperature When there is a difference between the temperature for zero point adjustment and the process temperature, the typical measured error is ±0.0003% of the full scale value / °C.

Influence of medium pressure The following section shows the effect on accuracy of mass flow due to a difference between calibration pressure and process pressure is negligible.



12.7 Installation

Installation instructions	→  10 et seq.
Inlet and outlet runs	There are no installation requirements regarding inlet and outlet runs.
System pressure	No special precautions regarding the system pressure are required, but observe the safety instructions on →  4 et seq.

12.8 Environment

Ambient temperature range	Measuring device: -40 to +60 °C (-40 to +140 °F)
	Note! <ul style="list-style-type: none"> ■ Install the device in a shady location. Avoid direct sunlight, particularly in warm climatic regions.
Storage temperature	-40 to +80 °C (-40 to +175 °F), preferably at +20 °C (+68 °F)
Degree of protection	Standard: IP 67 (NEMA 4X) for transmitter and sensor
Shock resistance	In accordance with IEC 60068-2-31 and EN 60721 (Class 2M3)
Vibration resistance	In accordance with IEC 60068-2-31 and EN 60721 (Class 2M3)
Electromagnetic compatibility (EMC)	As per IEC/EN 61326

12.9 Process

Medium temperature range	-50 to +125 °C (-58 to +257 °F)
Limiting medium pressure range	Max. 350 bar (5080 psi)
Pressure-temperature ratings	An overview of the Pressure-temperature ratings for the process connections is provided in the "Technical Information" document.
Rupture disk	Triggering pressure in the housing: 10 to 15 bar (145 to 217.5 psi), →  10 "Special mounting instructions".
Pressure loss	To calculate the pressure loss, use the <i>Applicator</i> sizing tool (→  36).
Limiting flow	Refer to the information on →  46, "Measuring range"

12.10 Mechanical construction

Design/dimensions

The dimensions and lengths of the sensor and transmitter are provided in the separate "Technical Information" document on the measuring device in question. This can be downloaded as a PDF file from www.endress.com. A list of the "Technical Information" documents available is provided in the "Documentation" section →  52.

Weight

DN in mm (in)	08 (3/8")	15 (1/2")	25 (1")
Weight in kg (pounds)	6.4 (14.1)	8.3 (18.3)	9.3 (20.5)

Material

Transmitter housing:

Powder coated die-cast aluminum

Sensor housing:

Acid-resistant and alkali-resistant external surface, stainless steel 1.4301 (304)

Process connection:

1.4404 (316)

Measuring tubes:

Stainless steel 1.4435 (316L)

Process connections

Cylindrical internal thread BSP (G) in accordance with ISO 228-1 with sealing surfaces in accordance with DIN 3852-2/ISO 1179-1:

- G 1/2" for DN 08
- G 3/4" for DN 15
- G 1" for DN 25



Note!

Sealed with profile seal as in accordance with DIN 3869 or copper disk or steel seal disk with plastic lip.

12.11 Operability

Local display

Display element

Status LED: There is a Light Emitting Diode (LED) on the meter electronics board that allows simple fault diagnostics.

Control elements

Device-internal DIP switch.

Remote operation

Operating via Modbus RS485 and serviceinterface FXA291 (e.g. FieldCare)

12.12 Certificates and approvals

CE mark	The measuring system is in conformity with the statutory requirements of the EC Directives. Endress+Hauser confirms successful testing of the device by affixing to it the CE mark.
C-Tick symbol	The measuring system meets the EMC requirements of the Australian Communications and Media Authority (ACMA).
Ex approval	Information about currently available Ex versions (ATEX, FM, CSA etc.) can be supplied by your Endress+Hauser sales office on request. All information relevant to explosion protection is available in separate Ex documents that you can order as necessary.
Approval for custody transfer	→  33
Modbus certification	The measuring device meets all the requirements of the Modbus/TCP conformity and integration test and has the "Modbus/TCP Conformance Test Policy, Version 2.0". The measuring device has successfully passed all the test procedures carried out and is certified by the "Modbus/TCP Conformance Test Laboratory" of the University of Michigan.
Pressure measuring device approval	<p>The measuring devices can be ordered with or without PED (Pressure Equipment Directive). If a device with PED is required, this must be ordered explicitly. For devices with nominal diameters less than or equal to DN 25 (1"), this is neither possible nor necessary.</p> <ul style="list-style-type: none"> ▪ With the identification PED/G1/III on the sensor nameplate, Endress+Hauser confirms conformity with the "Basic safety requirements" of Appendix I of the Pressure Equipment Directive 97/23/EC. ▪ Devices with this identification (with PED) are suitable for the following types of fluid: <ul style="list-style-type: none"> – Fluids of Group 1 and 2 with a steam pressure greater than, or smaller and equal to 0.5 bar (7.3 psi) – Unstable gases ▪ Devices without this identification (without PED) are designed and manufactured according to good engineering practice. They correspond to the requirements of Art. 3, Section 3 of the Pressure Equipment Directive 97/23/EC. Their application is illustrated in Diagrams 6 to 9 in Appendix II of the Pressure Equipment Directive 97/23/EC.
Other standards and guidelines	<ul style="list-style-type: none"> ▪ EN 60529 Degrees of protection provided by enclosures (IP code) ▪ EN 61010-1 Safety requirements for electrical equipment for measurement, control and laboratory use ▪ IEC/EN 61326 "Emission in accordance with Class A requirements". Electromagnetic compatibility (EMC-requirements) ▪ EN 60721 Shock and vibration resistance ▪ OIML R139 Suitability for custody transfer measurement

12.13 Accessories/spare parts







→  36

12.14 Documentation

- Flow measurement (FA00005D)
- Technical Information (TI00077D)
- Ex-Supplementary documentation ATEX (II2G): (XA00115D)
- Ex-Supplementary documentation FM, CSA (Div. 1): (XA00116D)
- Ex-Supplementary documentation NEPSI (Zone 1, Zone 21): (XA00123D)

13 Appendix – Device Functions

This appendix provides detailed descriptions and information about the individual instrument functions. All instrument functions can be selected and configured using the "FieldCare" configuration program from Endress+Hauser and via Modbus RS485 →  30. For measuring instruments with customer-specific parameter configuration, certain values and/or settings may differ from the factory settings listed above.

Block SECURITY	→  58
Block MEASURED VARIABLE	→  58
Block TOTALIZER	→  62
Block OUTPUTS	→  65
Block BASIC FUNCTION	→  78
Block SUPERVISION	→  93

13.1 Display of function matrix

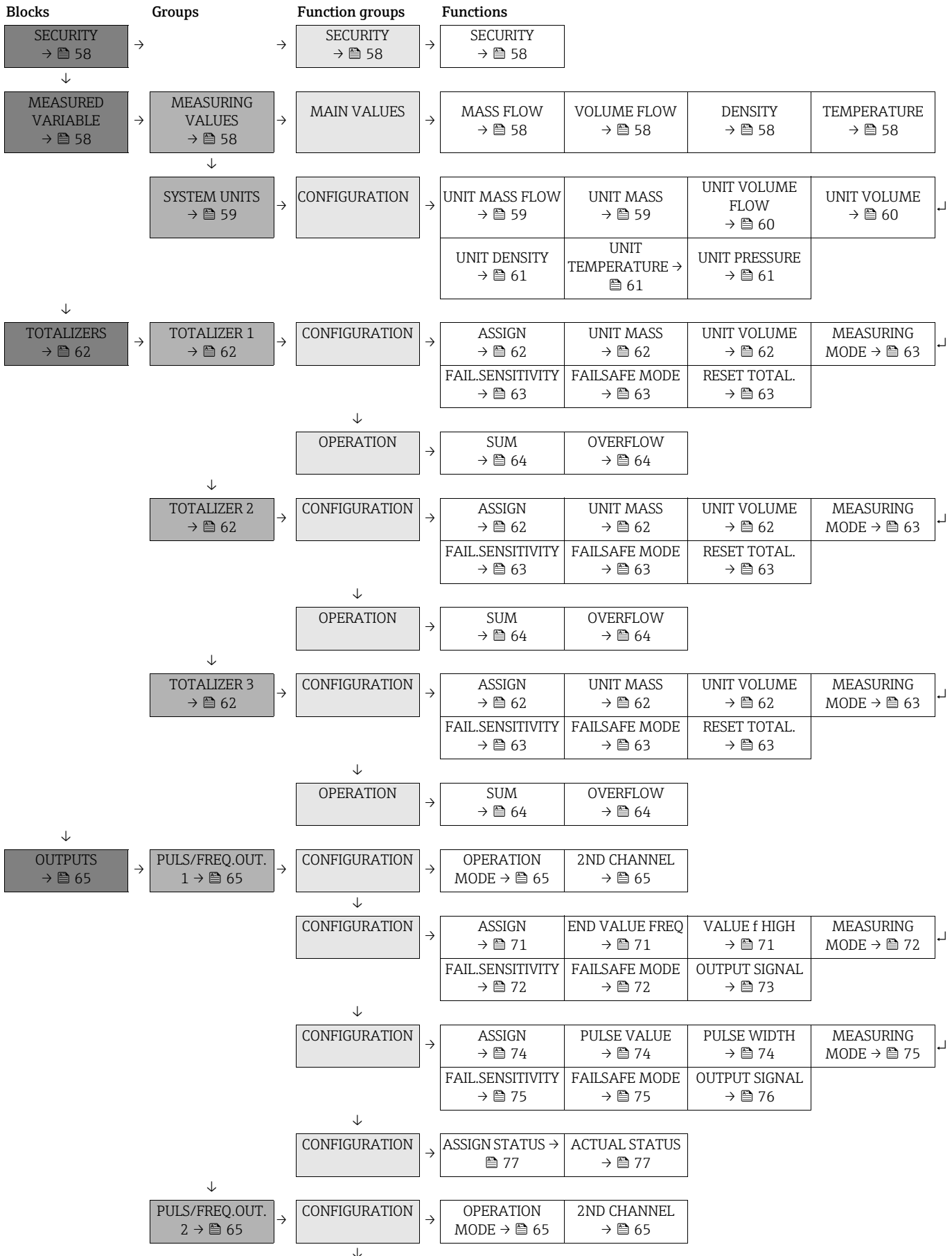

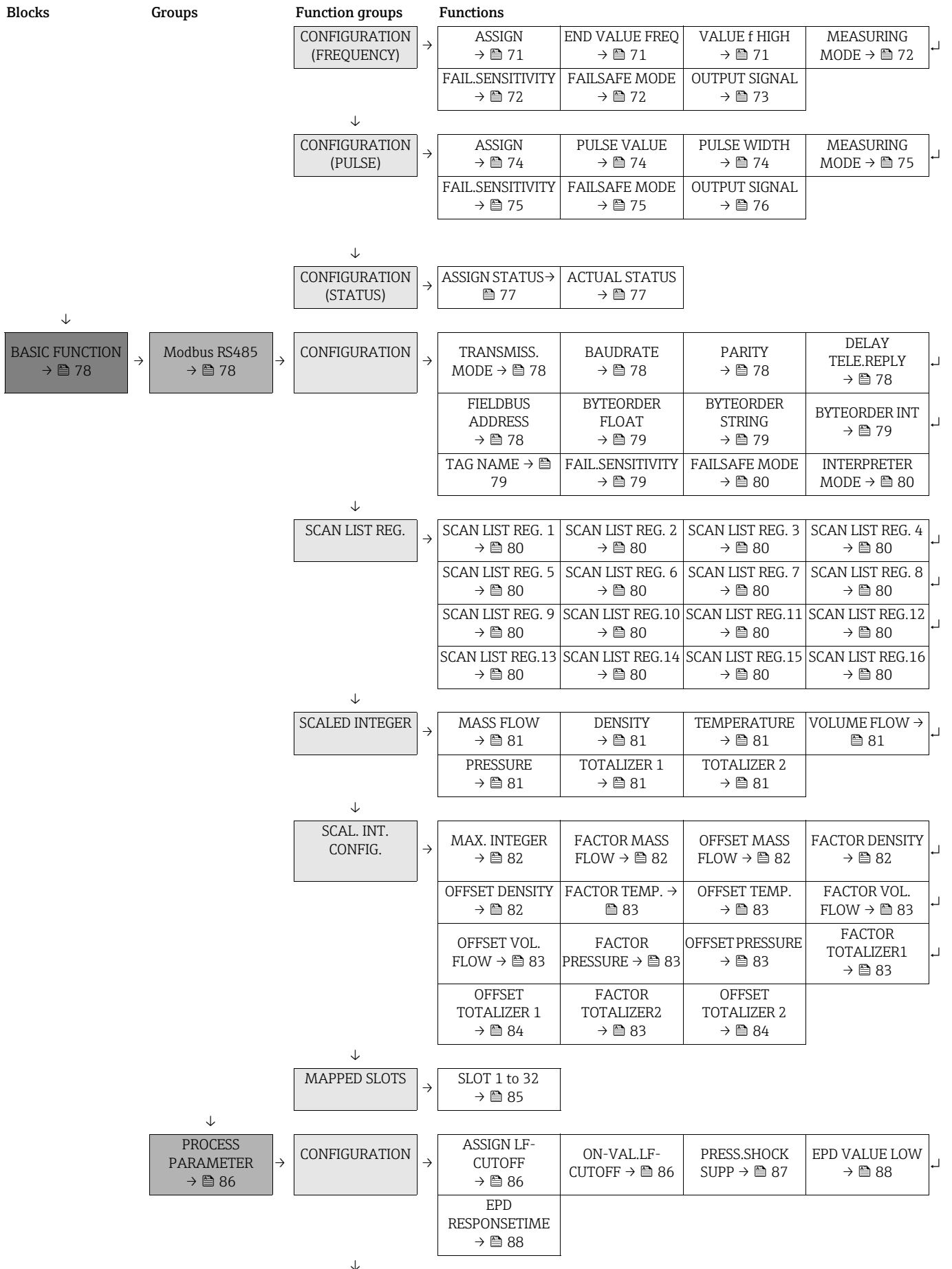

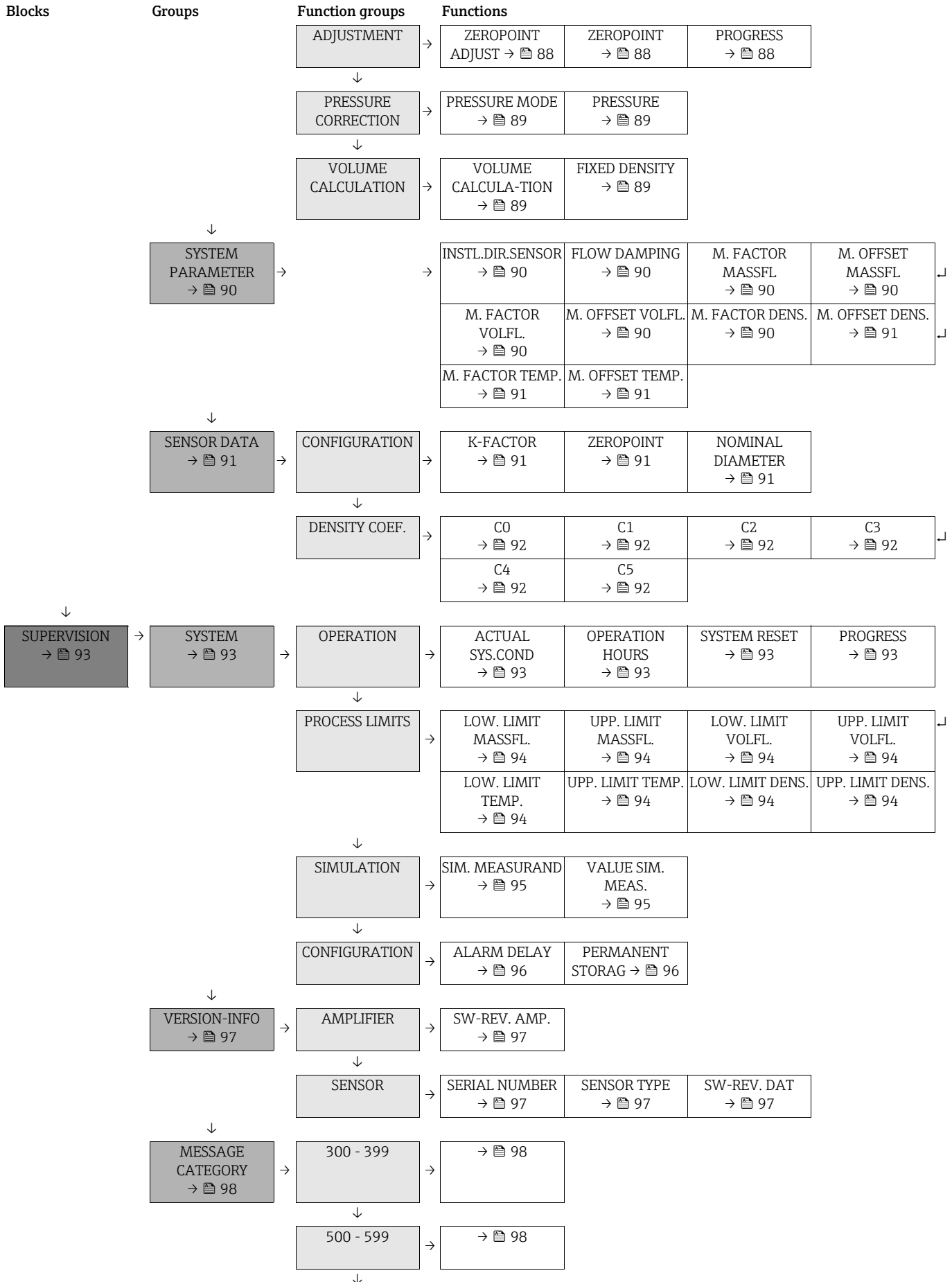

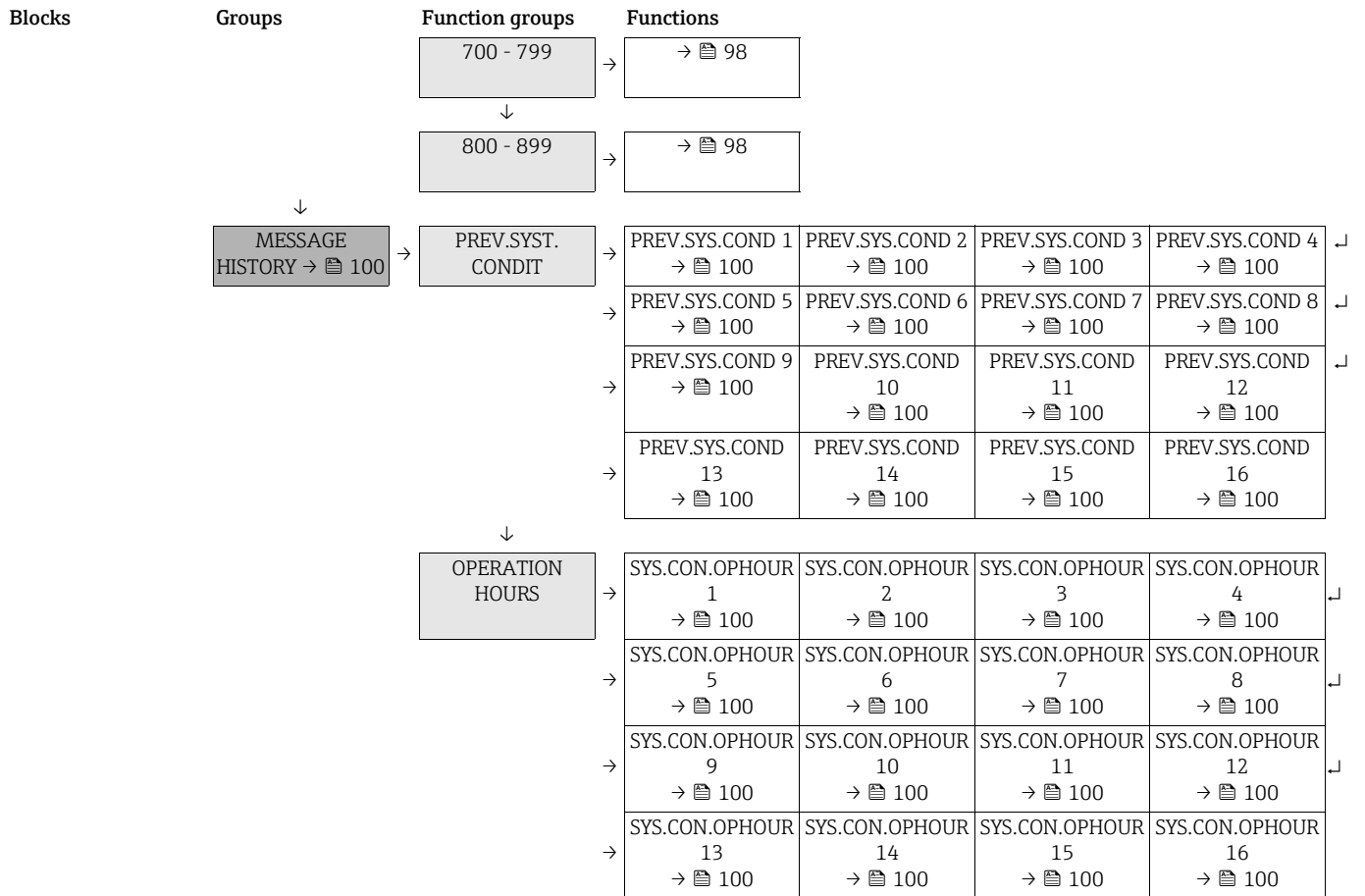

13.2 Block "SECURITY"

13.2.1 Group "SECURITY"

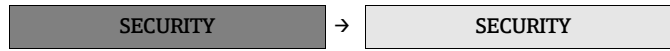

Function description SECURITY → SECURITY	
<p> Note! A hardware switch is used to switch from "SECURITY" to "no SECURITY". For detailed information about the function of the hardware switch, refer to → 34.</p>	
<p>SECURITY</p> <p>Modbus register: 7551 Data type: Integer Access: Read</p>	<p>Displays whether the SECURITY function is enabled or disabled.</p> <p>Display: 0 = OFF 1 = ON</p> <p>Factory setting: OFF</p>

13.3 Block "MEASURED VARIABLE"

13.3.1 Group "MEASURING VALUES"



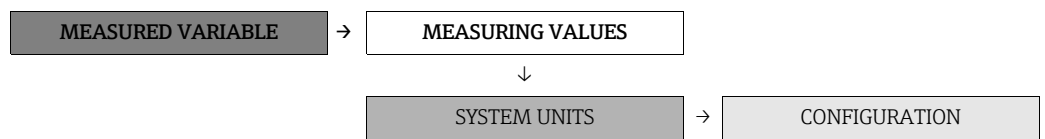

Function description MEASURED VARIABLE → MEASURING VALUES → MAIN VALUES	
<p> Note! The engineering units of all the measured variables shown here can be set in the "SYSTEM UNITS" group.</p>	
<p>MASS FLOW</p> <p>Modbus register: 2007 Data type: Float Access: Read</p>	<p>Displays the currently measured mass flow.</p>
<p>VOLUME FLOW</p> <p>Modbus register: 2009 Data type: Float Access: Read</p>	<p>Displays the calculated volume flow. The volume flow is derived from the measured mass flow and the measured density of the fluid.</p>
<p>DENSITY</p> <p>Modbus register: 2013 Data type: Float Access: Read</p>	<p>Displays the currently measured density or its specific gravity.</p>
<p>TEMPERATURE</p> <p>Modbus register: 2017 Data type: Float Access: Read</p>	<p>Displays the currently measured temperature.</p>

13.3.2 Group "SYSTEM UNITS"



Function description MEASURED VARIABLE → SYSTEM UNITS	
<p>UNIT MASS FLOW</p> <p>Modbus register: 2101</p> <p>Data type: Integer</p> <p>Access: read/write</p>	<p>For selecting the desired unit for the mass flow (mass/time).</p> <p>Options:</p> <p>Metric: 0 to 3 = gram → g/s; g/min; g/h; g/day 4 to 7 = kilogram → kg/s; kg/min; kg/h; kg/day 8 to 11 = ton → t/s; t/min; t/h; t/day</p> <p>US: 12 to 15 = ounce → oz/s; oz/min; oz/h; oz/day 16 to 19 = pound → lb/s; lb/min; lb/h; lb/day 20 to 23 = ton → ton/s; ton/min; ton/h; ton/day</p> <p>Factory setting: Country-dependent (kg/min or lb/min)</p>
<p>UNIT MASS</p> <p>Modbus register: 2102</p> <p>Data type: Integer</p> <p>Access: read/write</p>	<p>For selecting the desired unit for the mass.</p> <p>Options:</p> <p>0; 1; 2 = metric → g; kg; t</p> <p>3; 4; 5 = US → oz; lb; ton</p> <p>Factory setting: Country-dependent (kg or lb)</p> <p> Note! The unit of the totalizers is independent of your choice here. The unit for each totalizer is selected separately for the totalizer in question.</p>

Function description	
MEASURED VARIABLE → SYSTEM UNITS	
<p>UNIT VOLUME FLOW</p> <p>Modbus register: 2103</p> <p>Data type: Integer</p> <p>Access: read/write</p>	<p>For selecting the desired unit for the volume flow (volume/time).</p> <p>Options:</p> <p>Metric: 0 to 3 = cubic centimeter → cm³/s; cm³/min; cm³/h; cm³/day 4 to 7 = cubic decimeter → dm³/s; dm³/min; dm³/h; dm³/day 8 to 11 = cubic meter → m³/s; m³/min; m³/h; m³/day 12 to 15 = milliliter → ml/s; ml/min; ml/h; ml/day 16 to 19 = liter → l/s; l/min; l/h; l/day 20 to 23 = hectoliter → hl/s; hl/min; hl/h; hl/day 24 to 27 = megaliter → Ml/s; Ml/min; Ml/h; Ml/day</p> <p>US: 28 to 31 = cubic centimeter → cc/s; cc/min; cc/h; cc/day 32 to 35 = acre foot → af/s; af/min; af/h; af/day 36 to 39 = cubic foot → ft³/s; ft³/min; ft³/h; ft³/day 40 to 43 = fluid ounce → oz f/s; oz f/min; oz f/h; oz f/day 44 to 47 = gallon → gal/s; gal/min; gal/h; gal/day 52 to 55 = barrel (normal fluids: 31.5 gal/bbl) → bbl/s; bbl/min; bbl/h; bbl/day 56 to 59 = barrel (beer: 36.0 gal/bbl) → bbl/s; bbl/min; bbl/h; bbl/day 60 to 63 = Barrel (petrochemicals: 42.0 gal/bbl) → bbl/s; bbl/min; bbl/h; bbl/day 64 to 67 = Barrel (filling tanks: 55.0 gal/bbl) → bbl/s; bbl/min; bbl/h; bbl/day</p> <p>Imperial: 68 to 71 = gallon → gal/s; gal/min; gal/h; gal/day 76 to 79 = barrel (beer: 36.0 gal/bbl) → bbl/s; bbl/min; bbl/h; bbl/day 80 to 83 = Barrel (petrochemicals: 34.97 gal/bbl) → bbl/s; bbl/min; bbl/h; bbl/day</p> <p>Factory setting: Country-dependent (l/min or US gal/min)</p>
<p>UNIT VOLUME</p> <p>Modbus register: 2104</p> <p>Data type: Integer</p> <p>Access: read/write</p>	<p>For selecting the desired unit for the volume.</p> <p>Options:</p> <p>Metric: 0 to 6 = cm³; dm³; m³; ml; l; hl; Ml</p> <p>US: 7 to 16 = cc; af; ft³; oz f; gal; bbl (normal fluids); bbl (beer); bbl (petrochemicals); bbl (filling tanks);</p> <p>Imperial: 17; 19; 20 = gal; bbl (beer); bbl (petrochemicals)</p> <p>Factory setting: Country-dependent (l or US gal)</p> <p> Note! The unit of the totalizers is independent of your choice here. The unit for each totalizer is selected separately for the totalizer in question.</p>

Function description	
MEASURED VARIABLE → SYSTEM UNITS	
<p>UNIT DENSITY</p> <p>Modbus register: 2107</p> <p>Data type: Integer</p> <p>Access: read/write</p>	<p>For selecting the desired unit for the density.</p> <p>Options: Metric: 0...10 = g/cm³; g/cc; kg/dm³; kg/l; kg/m³; SD 4 °C, SD 15 °C, SD 20 °C; SG 4 °C, SG 15 °C, SG 20 °C</p> <p>US: 11 to 16 = lb/ft³; lb/gal; lb/bbl (normal fluids); lb/bbl (beer); lb/bbl (petrochemicals); lb/bbl (filling tanks)</p> <p>Imperial: 17 to 19 = lb/gal; lb/bbl (beer); lb/bbl (petrochemicals)</p> <p>Factory setting: Country-dependent (kg/l or g/cc)</p> <p> Note! SD = Specific Density, SG = Specific Gravity The specific density is the ratio of fluid density to water density (at water temperature = 4, 15, 20 °C (39, 59, 68 °F)).</p>
<p>UNIT TEMPERATURE</p> <p>Modbus register: 2109</p> <p>Data type: Integer</p> <p>Access: read/write</p>	<p>For selecting the desired unit for the temperature.</p> <p>Options: 0 = °C (Celsius) 1 = K (Kelvin) 2 = °F (Fahrenheit)</p> <p>Factory setting: Country-dependent (°C or °F)</p>
<p>UNIT PRESSURE</p> <p>Modbus register: 2130</p> <p>Data type: Integer</p> <p>Access: read/write</p>	<p>For selecting the desired unit for the pressure.</p> <p>Options: 0 = bara 1 = barg 2 = psia 3 = psig</p> <p>Factory setting: Country-dependent (barg or psig)</p>

13.4 Block "TOTALIZER"

13.4.1 Group "TOTALIZER (1 to 3)"

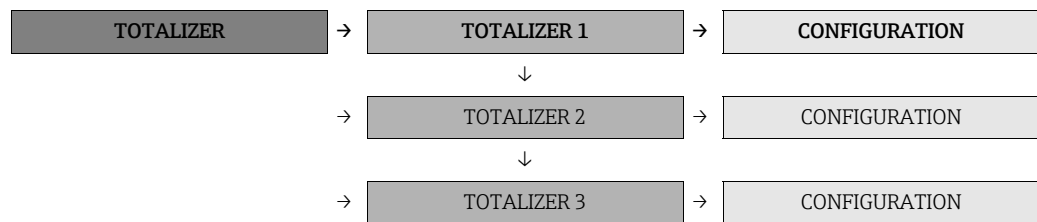

Function description TOTALIZER → TOTALIZER 1 to 3 → CONFIGURATION	
<p> Note! The function descriptions below apply to totalizers 1 to 3; the totalizers are independently configurable.</p>	
<p>ASSIGN</p> <p>Modbus register: Totalizer 1 2601 Totalizer 2 2801 Totalizer 3 3001 Data type: Integer Access: read/ write</p>	<p>For assigning a measured variable to the totalizer in question.</p> <p>Options: 0 = OFF 1 = MASS FLOW 2 = VOLUME FLOW</p> <p>Factory setting: MASS FLOW</p> <p> Note! If 0 = OFF is selected and the options are changed, the value of the totalizer is reset to 0.</p>
<p>UNIT MASS</p> <p>Modbus register: Totalizer 1 2602 Totalizer 2 2802 Totalizer 3 3002 Data type: Integer Access: read/ write</p>	<p>For selecting the unit for the measured variable assigned in the function ASSIGN.</p> <p>Options: Metric: 0 to 2 = g; kg; t</p> <p>US: 3 to 5 = oz; lb; ton</p> <p>Factory setting: Country-dependent (kg or lb)</p>
<p>UNIT VOLUME</p> <p>Modbus register: Totalizer 1 2603 Totalizer 2 2803 Totalizer 3 3003 Data type: Integer Access: read/ write</p>	<p>For selecting the unit for the measured variable assigned in the function ASSIGN.</p> <p>Options: Metric: 0 to 6 = cm³; dm³; m³; ml; l; hl; Ml</p> <p>US: 7 to 16 = cc; af; ft³; oz f; gal; bbl (normal fluids); bbl (beer); bbl (petrochemicals); bbl (filling tanks)</p> <p>Imperial: 17; 19; 20 = gal; bbl (beer); bbl (petrochemicals)</p> <p>Factory setting: Country-dependent (l or gal)</p>

Function description	
TOTALIZER → TOTALIZER 1 to 3 → CONFIGURATION	
<p>MEASURING MODE</p> <p>Modbus register: Totalizer 1 2605 Totalizer 2 2805 Totalizer 3 3005 Data type: Integer Access: read/ write</p>	<p>For selecting how the totalizer should operate.</p> <p>Options: 0 = BIDIRECTIONAL Positive and negative flow components are measured.</p> <p>1 = FORWARD Only positive flow components are measured.</p> <p>2 = BACKWARD Only negative flow components are measured.</p> <p>Factory setting: 1 = FORWARD</p>
<p>FAILURE SENSITIVITY</p> <p>Modbus register: Totalizer 1 2615 Totalizer 2 2815 Totalizer 3 3015 Data type: Integer Access: read/ write</p>	<p>Defines the status categories to which the totalizer reacts.</p> <p>Options: 0 = OFF The totalizer does not react to any status.</p> <p>1 = WARNING The totalizer reacts to warnings.</p> <p>2 = ERROR The totalizer reacts to errors.</p> <p>3 = ERRORS AND WARN. The totalizer reacts to errors and warnings.</p> <p>Factory setting: ERROR</p>
<p>FAILSAFE MODE</p> <p>Modbus register: Totalizer 1 2606 Totalizer 2 2806 Totalizer 3 3006 Data type: Integer Access: read/ write</p>	<p>Defines how the totalizer behaves when a status occurs of the category to which the totalizer is configured to react.</p> <p>Options: 0 = STOP The totalizer remains at a stop.</p> <p>1 = HOLD VALUE The totalizer resumes counting with the last value before the status occurred.</p> <p>Factory setting: STOP</p>
<p>RESET TOTALIZER</p> <p>Modbus register: Totalizer 1 2608 Totalizer 2 2808 Totalizer 3 3008 Data type: Integer Access: read/ write</p>	<p>Resets the total and the overflow of the totalizer (1...3) to zero.</p> <p>Options: 0 = CANCEL 1 = START</p>

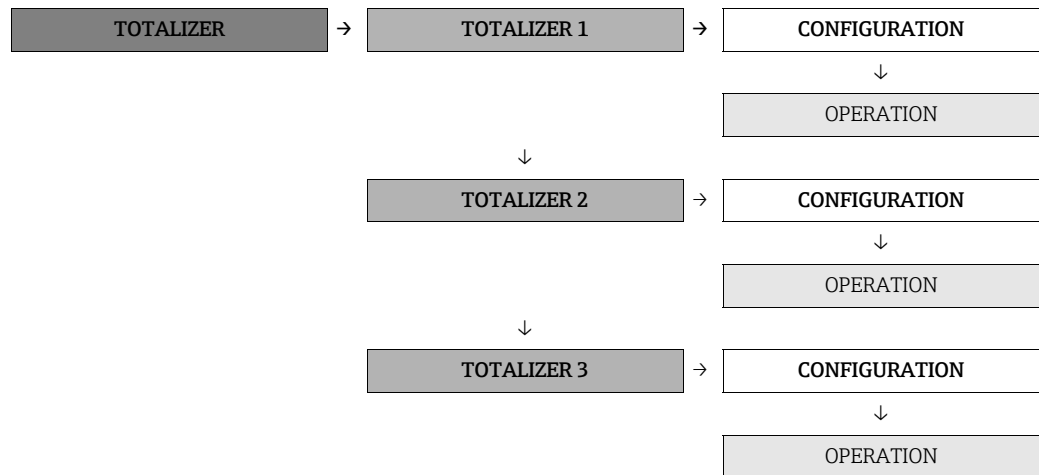

Function description TOTALIZER 1...3 → OPERATION	
<p> Note! The following function descriptions apply to totalizers 1 to 3.</p>	
<p>SUM</p> <p>Modbus register: Totalizer 1 2610 Totalizer 2 2810 Totalizer 3 3010 Data type: Float Access: Read</p>	<p>Displays the total for the totalizer's measured variable aggregated since the last reset.</p>
<p>OVERFLOW</p> <p>Modbus register: Totalizer 1 2612 Totalizer 2 2812 Totalizer 3 3012 Data type: Float Access: Read</p>	<p>Displays the totalized measured variable of the totalizer since the last reset above 10^7 in the selected unit.</p>

13.5 Block "OUTPUTS"

13.5.1 Group "PULSE/FREQUENCY OUTPUTS (1 to 2)"

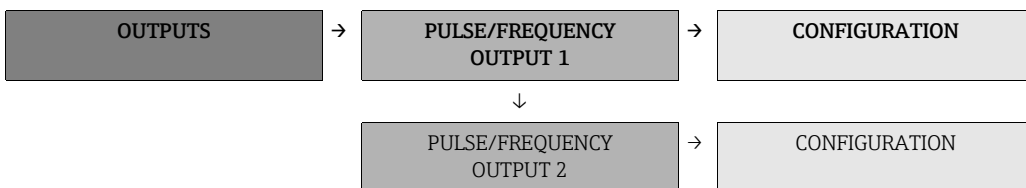

Function description OUTPUTS → PULSE/FREQUENCY OUTPUTS 1...2 → CONFIGURATION	
<p>OPERATION MODE</p> <p>Modbus register:</p> <p>Pulse/freq. output 1 3201 Pulse/freq. output 2 3401 Data type: Integer Access: read/ write</p>	<p>Configuration of the output as a pulse, frequency or status output.</p> <p>The functions available in this function group vary, depending on which option you select here.</p> <p>Options: 0 = PULSE 1 = FREQUENCY 2 = STATUS 3 = OFF</p> <p>Factory setting: Pulse/frequency output 1: PULSE Pulse/frequency output 2: PULSE</p>
<p>2ND CHANNEL</p> <p>Modbus register:</p> <p>Pulse/freq. output 1 3255 Pulse/freq. output 2 3455 Data type: Integer Access: read/ write</p>	<p>Selection for output of the assigned measured variable on PULS/FREQ.OUT. 2</p> <p>Options: 0 = OFF = no output 1 = REDUNDANCY 0° = repeated output without time delay 2 = REDUNDANCY 90° = repeated output with time delay of one-half of a pulse width 3 = REDUNDANCY 180° = repeated output with time delay of an entire pulse width 4 = PHASE SHIFT 0° = repeated output without phase shift 5 = PHASE SHIFT 90° = repeated output with 90° phase shift 6 = PHASE SHIFT 180° = repeated output with 180° phase shift</p> <p>Factory setting: OFF</p> <p> Note!</p> <ul style="list-style-type: none"> ■ REDUNDANCY 0°, REDUNDANCY 90° and REDUNDANCY 180° can be selected in PULSE mode of operation only. ■ PHASE SHIFT 0°, PHASE SHIFT 90° and PHASE SHIFT 180° can be selected in PULSE and FREQUENCY modes of operation.

Note!
The options selected in the functions OPERATION MODE and 2ND CHANNEL, and the resulting effects on the two pulse/frequency/status outputs, are illustrated on the following pages using examples.

Function description OUTPUTS → PULSE/FREQUENCY OUTPUTS 1...2 → CONFIGURATION																									
<p>Descriptions of pulse/frequency/status outputs</p>	<p>There are two pulse/frequency/status outputs, which can be operated independent or dependent of each other. In PULSE and FREQUENCY modes, flow measurement values can be output; in STATUS mode, statuses can be output. For example, the first pulse/frequency/status output can be used as the pulse output for mass flow, and the second pulse/frequency/status output can be used as the status output for the system status.</p> <p>If, for custody transfer reasons or due to the function of the downstream totalizer counter, a measured value must be output redundantly or phase-shifted, a logical pulse/frequency/status output assigns both physical outputs (selection with parameter 2ND CHANNEL). The other pulse/frequency/status output is then switched off, regardless of its mode of operation.</p> <p>The parameter 2ND CHANNEL is used to select the mode of the measured value output on the second channel. A distinction is made between the redundant pulse output REDUNDANCY in PULSE mode of operation and PHASE SHIFT in PULSE or FREQUENCY mode. Redundant pulse output means that a pulse in the first channel must always be followed by a corresponding pulse in the second channel. On the contrary, the phase shift relates to the period length of the output signal of the logically first channel.</p> <p>The following applies for the examples below:</p> <ul style="list-style-type: none"> ■ Wiring of pulse/frequency/status output 1 24 V DC via 1 kW pull-up at terminal 24 (+), terminal 25 (-) at ground, Signal tapped at terminal 24 (+) ■ Wiring of pulse/frequency/status output 2 24 V DC via 1 kW pull-up at terminal 22 (+), terminal 23 (-) at ground, Signal tapped at terminal 22 (+) 																								
<p>Example 1 (in metric units)</p>	<p>Mass flow = +3600 kg/h</p> <table border="1" style="width: 100%; border-collapse: collapse;"> <thead> <tr> <th style="text-align: left;">Parameter</th> <th style="text-align: left;">IFS output ①</th> <th style="text-align: left;">IFS output ②</th> </tr> </thead> <tbody> <tr> <td>OPERATION MODE</td> <td>Pulse</td> <td>Status</td> </tr> <tr> <td>2. CHANNEL</td> <td>Off</td> <td>-</td> </tr> <tr> <td>ASSIGN</td> <td>Mass flow</td> <td>Fault</td> </tr> <tr> <td>MEASURING MODE</td> <td>Bidirectional</td> <td>-</td> </tr> <tr> <td>PULSE VALUE</td> <td>0,001 kg</td> <td>-</td> </tr> <tr> <td>PULSE WIDTH</td> <td>0,25 ms</td> <td>-</td> </tr> <tr> <td>SIGNAL FORM</td> <td>Passive positive</td> <td>-</td> </tr> </tbody> </table> <div style="display: flex; align-items: flex-start;"> <div style="flex: 1;"> <p>Output signal:</p> <p>Pulse with 0,25 ms length Pulse rate = (3600 kg/h) / 0,001 kg = 1 kHz</p> <p>Gauge 0 V DC, because no error status active</p> </div> <div style="flex: 2;"> </div> </div>	Parameter	IFS output ①	IFS output ②	OPERATION MODE	Pulse	Status	2. CHANNEL	Off	-	ASSIGN	Mass flow	Fault	MEASURING MODE	Bidirectional	-	PULSE VALUE	0,001 kg	-	PULSE WIDTH	0,25 ms	-	SIGNAL FORM	Passive positive	-
Parameter	IFS output ①	IFS output ②																							
OPERATION MODE	Pulse	Status																							
2. CHANNEL	Off	-																							
ASSIGN	Mass flow	Fault																							
MEASURING MODE	Bidirectional	-																							
PULSE VALUE	0,001 kg	-																							
PULSE WIDTH	0,25 ms	-																							
SIGNAL FORM	Passive positive	-																							

A0006946-EN

Function description OUTPUTS → PULSE/FREQUENCY OUTPUTS 1...2 → CONFIGURATION																															
<p>Example 2 (in metric units)</p>	<p>Mass flow = +3600 kg/h</p> <table border="1"> <thead> <tr> <th>Parameter</th> <th>IFS output ①</th> <th>IFS output ②</th> </tr> </thead> <tbody> <tr> <td>OPERATION MODE</td> <td>Pulse</td> <td>Frequency</td> </tr> <tr> <td>2. CHANNEL</td> <td>Off</td> <td>Off</td> </tr> <tr> <td>ASSIGN</td> <td>Mass flow</td> <td>Mass flow</td> </tr> <tr> <td>MEASURING MODE</td> <td>Bidirectional</td> <td>Bidirectional</td> </tr> <tr> <td>PULSE VALUE</td> <td>0,001 kg</td> <td>-</td> </tr> <tr> <td>PULSE WIDTH</td> <td>0,25 ms</td> <td>-</td> </tr> <tr> <td>SIGNAL FORM</td> <td>Passive positive</td> <td>Passive positive</td> </tr> <tr> <td>END VALUE</td> <td>-</td> <td>36000 kg/h</td> </tr> <tr> <td>END VALUE FREQ.</td> <td>-</td> <td>5 kHz</td> </tr> </tbody> </table> <p>Output signal:</p> <p>Pulse with 0,25 ms length Pulse rate = $(3600 \text{ kg/h}) / 0,001 \text{ kg}$ = 1 kHz</p> <p>Frequency $f =$ $(3600 \text{ kg/h}) /$ $(36000 \text{ kg/h}) \times$ 5 kHz = 500 Hz</p> <p style="text-align: right; font-size: small;">A0006947-EN</p>	Parameter	IFS output ①	IFS output ②	OPERATION MODE	Pulse	Frequency	2. CHANNEL	Off	Off	ASSIGN	Mass flow	Mass flow	MEASURING MODE	Bidirectional	Bidirectional	PULSE VALUE	0,001 kg	-	PULSE WIDTH	0,25 ms	-	SIGNAL FORM	Passive positive	Passive positive	END VALUE	-	36000 kg/h	END VALUE FREQ.	-	5 kHz
Parameter	IFS output ①	IFS output ②																													
OPERATION MODE	Pulse	Frequency																													
2. CHANNEL	Off	Off																													
ASSIGN	Mass flow	Mass flow																													
MEASURING MODE	Bidirectional	Bidirectional																													
PULSE VALUE	0,001 kg	-																													
PULSE WIDTH	0,25 ms	-																													
SIGNAL FORM	Passive positive	Passive positive																													
END VALUE	-	36000 kg/h																													
END VALUE FREQ.	-	5 kHz																													
<p>Example 3 (in metric units)</p>	<p>Mass flow = +3600 kg/h</p> <table border="1"> <thead> <tr> <th>Parameter</th> <th>IFS output ①</th> <th>IFS output ②</th> </tr> </thead> <tbody> <tr> <td>OPERATION MODE</td> <td>Pulse</td> <td>Off*</td> </tr> <tr> <td>2ND CHANNEL</td> <td>Redundancy 90°</td> <td>-</td> </tr> <tr> <td>ASSIGN</td> <td>Mass flow</td> <td>-</td> </tr> <tr> <td>MEASURING MODE</td> <td>Bidirectional</td> <td>-</td> </tr> <tr> <td>PULSE VALUE</td> <td>0,001 kg</td> <td>-</td> </tr> <tr> <td>PULSE WIDTH</td> <td>0,25 ms</td> <td>-</td> </tr> <tr> <td>SIGNAL FORM</td> <td>Passive positive</td> <td>-</td> </tr> </tbody> </table> <p>* because 2ND CHANNEL on IFS 1 is set to Redundancy 90°.</p> <p>Output signal:</p> <p>Pulse with 0,25 ms length Pulse rate = $(3600 \text{ kg/h}) / 0,001 \text{ kg}$ = 1 kHz</p> <p>Pulse with 0,25 ms length Pulse rate = $(3600 \text{ kg/h}) / 0,001 \text{ kg}$ = 1 kHz, lagging half a pulse width, because mass flow is positive</p> <p style="text-align: right; font-size: small;">A0006948-EN</p>	Parameter	IFS output ①	IFS output ②	OPERATION MODE	Pulse	Off*	2ND CHANNEL	Redundancy 90°	-	ASSIGN	Mass flow	-	MEASURING MODE	Bidirectional	-	PULSE VALUE	0,001 kg	-	PULSE WIDTH	0,25 ms	-	SIGNAL FORM	Passive positive	-						
Parameter	IFS output ①	IFS output ②																													
OPERATION MODE	Pulse	Off*																													
2ND CHANNEL	Redundancy 90°	-																													
ASSIGN	Mass flow	-																													
MEASURING MODE	Bidirectional	-																													
PULSE VALUE	0,001 kg	-																													
PULSE WIDTH	0,25 ms	-																													
SIGNAL FORM	Passive positive	-																													

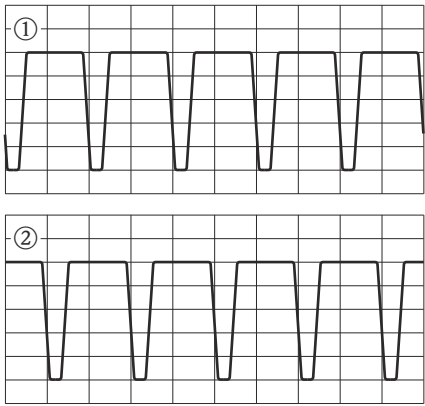
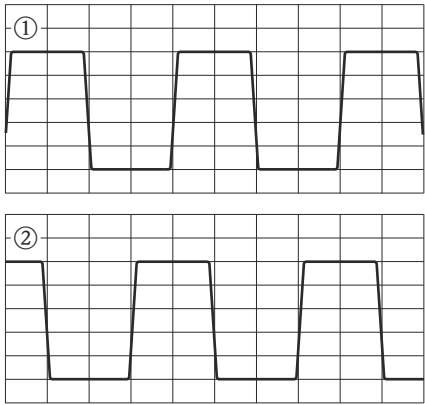

Function description OUTPUTS → PULSE/FREQUENCY OUTPUTS 1...2 → CONFIGURATION																									
<p>Example 4 (in metric units)</p>	<p>Mass flow = -3600 kg/h</p> <table border="1"> <thead> <tr> <th>Parameter</th> <th>IFS output ①</th> <th>IFS output ②</th> </tr> </thead> <tbody> <tr> <td>OPERATION MODE</td> <td>Pulse</td> <td>Off *</td> </tr> <tr> <td>2ND CHANNEL</td> <td>Redundancy 90°</td> <td>-</td> </tr> <tr> <td>ASSIGN</td> <td>Mass flow</td> <td>-</td> </tr> <tr> <td>MEASURING MODE</td> <td>Bidirectional</td> <td>-</td> </tr> <tr> <td>PULSE VALUE</td> <td>0,001 kg</td> <td>-</td> </tr> <tr> <td>PULSE WIDTH</td> <td>0,25 ms</td> <td>-</td> </tr> <tr> <td>SIGNAL FORM</td> <td>Passive positive</td> <td>-</td> </tr> </tbody> </table> <p>* because 2ND CHANNEL on IFS 1 is set to Redundancy 90°.</p> <p>Output signal:</p> <p>Pulse with 0,25 ms length Pulse rate = (3600 kg/h) / 0,001 kg = 1 kHz</p> <p>Pulse with 0,25 ms length Pulse rate = (3600 kg/h) / 0,001 kg = 1 kHz, advanced half a pulse width, because mass flow is negative</p> <p style="text-align: right;"><small>A0006949-EN</small></p>	Parameter	IFS output ①	IFS output ②	OPERATION MODE	Pulse	Off *	2ND CHANNEL	Redundancy 90°	-	ASSIGN	Mass flow	-	MEASURING MODE	Bidirectional	-	PULSE VALUE	0,001 kg	-	PULSE WIDTH	0,25 ms	-	SIGNAL FORM	Passive positive	-
Parameter	IFS output ①	IFS output ②																							
OPERATION MODE	Pulse	Off *																							
2ND CHANNEL	Redundancy 90°	-																							
ASSIGN	Mass flow	-																							
MEASURING MODE	Bidirectional	-																							
PULSE VALUE	0,001 kg	-																							
PULSE WIDTH	0,25 ms	-																							
SIGNAL FORM	Passive positive	-																							
<p>Example 5 (in metric units)</p>	<p>Mass flow = +3600 kg/h</p> <table border="1"> <thead> <tr> <th>Parameter</th> <th>IFS output ①</th> <th>IFS output ②</th> </tr> </thead> <tbody> <tr> <td>OPERATION MODE</td> <td>Pulse</td> <td>Off *</td> </tr> <tr> <td>2ND CHANNEL</td> <td>Phase shift 180°</td> <td>-</td> </tr> <tr> <td>ASSIGN</td> <td>Mass flow</td> <td>-</td> </tr> <tr> <td>MEASURING MODE</td> <td>Bidirectional</td> <td>-</td> </tr> <tr> <td>PULSE VALUE</td> <td>0,001 kg</td> <td>-</td> </tr> <tr> <td>PULSE WIDTH</td> <td>0,25 ms</td> <td>-</td> </tr> <tr> <td>SIGNAL FORM</td> <td>Passive positive</td> <td>-</td> </tr> </tbody> </table> <p>* because 2ND CHANNEL on IFS 1 is set to Phase shift 180°.</p> <p>Output signal:</p> <p>Pulse with 0,25 ms length Pulse rate = (3600 kg/h) / 0,001 kg = 1 kHz</p> <p>Pulse with 0,25 ms length Pulse rate = (3600 kg/h) / 0,001 kg = 1 kHz, phase-shift 180°.</p> <p style="text-align: right;"><small>A0006950-EN</small></p>	Parameter	IFS output ①	IFS output ②	OPERATION MODE	Pulse	Off *	2ND CHANNEL	Phase shift 180°	-	ASSIGN	Mass flow	-	MEASURING MODE	Bidirectional	-	PULSE VALUE	0,001 kg	-	PULSE WIDTH	0,25 ms	-	SIGNAL FORM	Passive positive	-
Parameter	IFS output ①	IFS output ②																							
OPERATION MODE	Pulse	Off *																							
2ND CHANNEL	Phase shift 180°	-																							
ASSIGN	Mass flow	-																							
MEASURING MODE	Bidirectional	-																							
PULSE VALUE	0,001 kg	-																							
PULSE WIDTH	0,25 ms	-																							
SIGNAL FORM	Passive positive	-																							

Function description OUTPUTS → PULSE/FREQUENCY OUTPUTS 1...2 → CONFIGURATION																									
<p>Example 6 (in metric units)</p>	<p>Mass flow = +3600 kg/h</p> <table border="1"> <thead> <tr> <th>Parameter</th> <th>IFS output ①</th> <th>IFS output ②</th> </tr> </thead> <tbody> <tr> <td>OPERATION MODE</td> <td>Pulse</td> <td>Off *</td> </tr> <tr> <td>2ND CHANNEL</td> <td>Phase shift 180°</td> <td>-</td> </tr> <tr> <td>ASSIGN</td> <td>Mass flow</td> <td>-</td> </tr> <tr> <td>MASURING MODE</td> <td>Bidirectional</td> <td>-</td> </tr> <tr> <td>PULSE VALUE</td> <td>0,001 kg</td> <td>-</td> </tr> <tr> <td>PULSE WIDTH</td> <td>0,25 ms</td> <td>-</td> </tr> <tr> <td>SIGNAL FORM</td> <td>Passive negative</td> <td>-</td> </tr> </tbody> </table> <p>* because 2ND CHANNEL on IFS 1 is set to Phase shift 180°</p> <p>Output signal:</p> <div style="display: flex; align-items: flex-start;"> <div style="flex: 1;"> <p>Pulse with 0,25 ms length Pulse rate = $(3600 \text{ kg/h}) / 0,001 \text{ kg}$ = 1 kHz</p> <p>Pulse with 0,25 ms length Pulse rate = $(3600 \text{ kg/h}) / 0,001 \text{ kg}$ = 1 kHz, phase-shift 180°.</p> </div> <div style="flex: 1;">  </div> </div> <p style="text-align: right; font-size: small;">A0006951-EN</p>	Parameter	IFS output ①	IFS output ②	OPERATION MODE	Pulse	Off *	2ND CHANNEL	Phase shift 180°	-	ASSIGN	Mass flow	-	MASURING MODE	Bidirectional	-	PULSE VALUE	0,001 kg	-	PULSE WIDTH	0,25 ms	-	SIGNAL FORM	Passive negative	-
Parameter	IFS output ①	IFS output ②																							
OPERATION MODE	Pulse	Off *																							
2ND CHANNEL	Phase shift 180°	-																							
ASSIGN	Mass flow	-																							
MASURING MODE	Bidirectional	-																							
PULSE VALUE	0,001 kg	-																							
PULSE WIDTH	0,25 ms	-																							
SIGNAL FORM	Passive negative	-																							
<p>Example 7 (in metric units)</p>	<p>Mass flow = +3600 kg/h</p> <table border="1"> <thead> <tr> <th>Parameter</th> <th>IFS output ①</th> <th>IFS output ②</th> </tr> </thead> <tbody> <tr> <td>OPERATION MODE</td> <td>Off *</td> <td>Frequency</td> </tr> <tr> <td>2ND CHANNEL</td> <td>-</td> <td>Phase shift 90°</td> </tr> <tr> <td>ASSIGN</td> <td>-</td> <td>Mass flow</td> </tr> <tr> <td>MEASURING MODE</td> <td>-</td> <td>Bidirectional</td> </tr> <tr> <td>SIGNAL FORM</td> <td>-</td> <td>Passive negative</td> </tr> <tr> <td>END VALUE</td> <td>-</td> <td>36000 kg/h</td> </tr> <tr> <td>END VALUE FREQ.</td> <td>-</td> <td>5 kHz</td> </tr> </tbody> </table> <p>* because 2ND CHANNEL on IFS 2 is set to Phase shift 90°</p> <p>Output signal:</p> <div style="display: flex; align-items: flex-start;"> <div style="flex: 1;"> <p>Frequency $f =$ $(3600 \text{ kg/h}) /$ $(36000 \text{ kg/h}) \times 5 \text{ kHz}$ $= 500 \text{ Hz}$, lagging 90°, because mass flow is positive</p> </div> <div style="flex: 1;">  </div> </div> <p style="text-align: right; font-size: small;">A0006952-EN</p>	Parameter	IFS output ①	IFS output ②	OPERATION MODE	Off *	Frequency	2ND CHANNEL	-	Phase shift 90°	ASSIGN	-	Mass flow	MEASURING MODE	-	Bidirectional	SIGNAL FORM	-	Passive negative	END VALUE	-	36000 kg/h	END VALUE FREQ.	-	5 kHz
Parameter	IFS output ①	IFS output ②																							
OPERATION MODE	Off *	Frequency																							
2ND CHANNEL	-	Phase shift 90°																							
ASSIGN	-	Mass flow																							
MEASURING MODE	-	Bidirectional																							
SIGNAL FORM	-	Passive negative																							
END VALUE	-	36000 kg/h																							
END VALUE FREQ.	-	5 kHz																							

Function description OUTPUTS → PULSE/FREQUENCY OUTPUTS 1...2 → CONFIGURATION																															
<p>Example 8 (in metric units)</p>	<p>Mass flow = +3600 kg/h*</p> <table border="1" style="width: 100%; border-collapse: collapse;"> <thead> <tr> <th style="width: 30%;">Parameter</th> <th style="width: 35%;">IFS output ①</th> <th style="width: 35%;">IFS output ②</th> </tr> </thead> <tbody> <tr> <td>OPERATION MODE</td> <td>Status</td> <td>Frequency</td> </tr> <tr> <td>2ND CHANNEL</td> <td>-</td> <td>Off</td> </tr> <tr> <td>ASSIGN</td> <td>Fault</td> <td>Mass flow</td> </tr> <tr> <td>MEASURING MODE</td> <td>-</td> <td>Bidirectional</td> </tr> <tr> <td>SIGNAL FORM</td> <td>-</td> <td>Passive positive</td> </tr> <tr> <td>END VALUE</td> <td>-</td> <td>36000 kg/h</td> </tr> <tr> <td>END VALUE FREQ.</td> <td>-</td> <td>5 kHz</td> </tr> <tr> <td>FAIL SAFE MODE</td> <td>-</td> <td>Max. value</td> </tr> <tr> <td>FAULT SENSITIVITY</td> <td>-</td> <td>Fault</td> </tr> </tbody> </table> <p>* but error condition #587 is active</p> <div style="display: flex; align-items: flex-start;"> <div style="flex: 1;"> <p>Output signal:</p> <p>Gauge 24 VDC, because fail safe mode is active</p> <p>Frequency f = 5 kHz, because highly possible end value frequency</p> </div> <div style="flex: 2;"> <p>The diagram shows two digital signals over time. Signal ① is a square wave with a period of approximately 100 ns. Signal ② is a square wave with a period of approximately 20 ns. Both signals are shown as high (active) pulses.</p> </div> </div>	Parameter	IFS output ①	IFS output ②	OPERATION MODE	Status	Frequency	2ND CHANNEL	-	Off	ASSIGN	Fault	Mass flow	MEASURING MODE	-	Bidirectional	SIGNAL FORM	-	Passive positive	END VALUE	-	36000 kg/h	END VALUE FREQ.	-	5 kHz	FAIL SAFE MODE	-	Max. value	FAULT SENSITIVITY	-	Fault
Parameter	IFS output ①	IFS output ②																													
OPERATION MODE	Status	Frequency																													
2ND CHANNEL	-	Off																													
ASSIGN	Fault	Mass flow																													
MEASURING MODE	-	Bidirectional																													
SIGNAL FORM	-	Passive positive																													
END VALUE	-	36000 kg/h																													
END VALUE FREQ.	-	5 kHz																													
FAIL SAFE MODE	-	Max. value																													
FAULT SENSITIVITY	-	Fault																													





A0006953-EN



Function description OUTPUTS → PULSE/FREQUENCY OUTPUT 1...2 → CONFIGURATION (frequency)	
<p>ASSIGN</p> <p>Modbus register: Pulse/freq. output 1 3202 Pulse/freq. output 2 3402 Data type: Integer Access: read/ write</p>	<p>Assign a measured variable to the output.</p> <p> Note! Function is not available unless the FREQUENCY setting was selected in the OPERATION MODE function.</p> <p>Options: 0 = OFF 2 = MASS FLOW 5 = VOLUME FLOW</p> <p>Factory setting: MASS FLOW</p>
<p>END VALUE FREQUENCY</p> <p>Modbus register: Pulse/freq. output 1 3205 Pulse/freq. output 2 3405 Data type: Float Access: read/ write</p>	<p>For defining an end value frequency for the frequency output. Assign the corresponding measured value to the measuring range in the function VALUE f HIGH (see below).</p> <p> Note! Function is not available unless the FREQUENCY setting was selected in the OPERATION MODE function.</p> <p>User input: 5-digit fixed-point number: 100 to 5000 Hz</p> <p>Factory setting: 1000 Hz</p> <p>Example:</p> <ul style="list-style-type: none"> ▪ VALUE f HIGH = 1000 kg/h, end value frequency = 1000 Hz: i.e. a frequency of 1000 Hz is output at a flow of 1000 kg/h. ▪ VALUE f HIGH = 3600 kg/h, end value frequency = 5000 Hz: i.e. a frequency of 5000 Hz is output at a flow of 3600 kg/h. <p> Note! In the FREQUENCY operating mode, the output signal is symmetrical (on/off ratio = 1:1).</p>
<p>VALUE f HIGH</p> <p>Modbus register: Pulse/freq. output 1 3209 Pulse/freq. output 2 3409 Data type: Float Access: read/ write</p>	<p>In this function, a value is assigned to the END VALUE FREQ. Determine the desired span by defining VALUE f HIGH.</p> <p> Note! Function is not available unless the FREQUENCY setting was selected in the OPERATION MODE function.</p> <p>User input: Floating-point number</p> <p>Factory setting: Depends on nominal diameter</p> <div style="text-align: center;"> </div> <p><i>Fig. 21: Behavior of frequency output</i></p> <p>A0007114</p> <p>a = Span A = Frequency [%] B = Measured variable (amount) 1 = VALUE f HIGH (END VALUE FREQ)</p> <p> Note! A value greater than VALUE f HIGH cannot be output; otherwise, a message is generated (#355/#356). We recommend providing reserve capacity during parameter configuration.</p>

Function description									
OUTPUTS → PULSE/FREQUENCY OUTPUT 1...2 → CONFIGURATION (frequency)									
<p>MEASURING MODE</p> <p>Modbus register: Pulse/freq. output 1 3211 Pulse/freq. output 2 3411 Data type: Integer Access: read/ write</p>	<p>Use this function to define the measuring mode for the frequency output.</p> <p> Note! Function available only if PULSE or FREQUENCY has been selected in the MODE OF OPERATION function.</p> <p>Options: 0 = FORWARD 1 = BIDIRECTIONAL 3 = BACKWARD</p> <p>Factory setting: FORWARD</p> <p>Description of the individual options:</p> <p>FORWARD Only positive flow rates are output. Negative flow rates are cut off. If the output is again on the second PULS/FREQ.OUT., the time delay or phase shift is lagging.</p> <p>BIDIRECTIONAL Positive and negative flow rates are output. Only the amount of the flow is relevant for generating the pulses or frequency. If the output is again at the second PULS/FREQ.OUT., the time delay or phase shift is lagging if the flow rate is positive and leading if the flow rate is negative.</p> <p>BACKWARD Only negative flow rates are output. Positive flow rates are cut off. If the output is again on the second PULS/FREQ.OUT., the time delay or phase shift is leading.</p>								
<p>FAILURE SENSITIVITY</p> <p>Modbus register: Pulse/freq. output 1 3256 Pulse/freq. output 2 3456 Data type: Integer Access: read/ write</p>	<p>Defines the message categories to which the output reacts.</p> <p>Options: 0 = OFF = The output does not react to any status. 1 = WARNING = The output reacts to warnings. 2 = ERROR = The output reacts to errors. 3 = ERROR AND WARN. = The output reacts to errors and warnings</p> <p>Factory setting: ERROR</p>								
<p>FAILSAFE MODE</p> <p>Modbus register: Pulse/freq. output 1 3215 Pulse/freq. output 2 3415 Data type: Integer Access: read/ write</p>	<p>Defines how the PULS/FREQ.OUT. behaves when a message occurs of the category to which the PULS/FREQ.OUT. is configured to react.</p> <p> Note! Function is not available unless the FREQUENCY setting was selected in the OPERATION MODE function.</p> <p>Options: 0 = FALLBACK VALUE Output is 0 Hz. 2 = HOLD VALUE Measured value display on the basis of the last measured value preceding occurrence of the status. 4 = HIGH VALUE Output of the highest possible pulse rate or frequency.</p> <p>Factory setting: FALLBACK VALUE</p> <p> Note! If OFF is not selected for 2ND CHANNEL, the failsafe mode of channel 2 is as follows:</p> <table border="1" style="margin-left: auto; margin-right: auto;"> <thead> <tr> <th>1st channel</th> <th>2nd channel</th> </tr> </thead> <tbody> <tr> <td>FALLBACK VALUE</td> <td>HIGH VALUE</td> </tr> <tr> <td>HOLD VALUE</td> <td>HOLD VALUE</td> </tr> <tr> <td>HIGH VALUE</td> <td>FALLBACK VALUE</td> </tr> </tbody> </table>	1st channel	2nd channel	FALLBACK VALUE	HIGH VALUE	HOLD VALUE	HOLD VALUE	HIGH VALUE	FALLBACK VALUE
1st channel	2nd channel								
FALLBACK VALUE	HIGH VALUE								
HOLD VALUE	HOLD VALUE								
HIGH VALUE	FALLBACK VALUE								

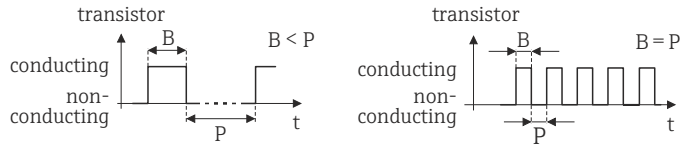

A0007100-EN

Function description	
OUTPUTS → PULSE/FREQUENCY OUTPUT 1...2 → CONFIGURATION (frequency)	
<p>OUTPUT SIGNAL</p> <p>Modbus register: Pulse/freq. output 1 3212 Pulse/freq. output 2 3412 Data type: Integer Access: read/write</p>	<p>Use this function to select the polarity of the output signal.</p> <p> Note! Function is not available unless the FREQUENCY setting was selected in the OPERATION MODE function.</p> <p>Options: 0 = PASSIVE/POSITIVE 1 = PASSIVE/NEGATIVE</p> <p>Factory setting: PASSIVE/POSITIVE</p> <p>Description of the individual options: PASSIVE/POSITIVE The output transistor is nonconductive during the first half of the period of the output signal and conductive during the second half of the period.</p> <p>PASSIVE/NEGATIVE The output transistor is conductive during the first half of the period of the output signal and nonconductive during the second half of the period.</p>

Function description	
OUTPUTS → PULSE/FREQUENCY OUTPUT 1...2 → CONFIGURATION (impulse)	
<p>ASSIGN</p> <p>Modbus register: Pulse/freq. output 1 3223 Pulse/freq. output 2 3423 Data type: Integer Access: read/write</p>	<p>Assign a measured variable to the output.</p> <p> Note! Function is not available unless the PULSE setting was selected in the OPERATION MODE function.</p> <p>Options: 0 = OFF 2 = MASS FLOW 5 = VOLUME FLOW</p> <p>Factory setting: MASS FLOW</p>
<p>PULSE VALUE</p> <p>Modbus register: Pulse/freq. output 1 3224 Pulse/freq. output 2 3424 Data type: Float Access: read/write</p>	<p>Use this function to define the flow at which a pulse is triggered. These pulses can be totaled by an external totalizer, and the total flow quantity since measuring started can be registered in this way.</p> <p> Note! Function is not available unless the PULSE setting was selected in the OPERATION MODE function.</p> <p>User input: Floating-point number</p> <p>Factory setting: Depends on nominal diameter</p>
<p>PULSE WIDTH</p> <p>Modbus register: Pulse/freq. output 1 3226 Pulse/freq. output 2 3426 Data type: Float Access: read/write</p>	<p>Use this function to enter the pulse width of the output pulse.</p> <p> Note! Function is not available unless the PULSE setting was selected in the OPERATION MODE function.</p> <p>User input: 0.1 to 1000 ms</p> <p>Factory setting: 1 ms</p> <p>Pulse output is always with the pulse width (B) entered in this function. The pauses (P) between the individual pulses are automatically configured. However, they must at least correspond to the pulse width (B = P).</p> <div style="text-align: center;">  </div> <p style="text-align: right; font-size: small;">A0001233-en</p> <p><i>Fig. 22: Pulse Width</i></p> <p>B = Pulse width entered (the illustration applies to positive pulses) P = Pauses between the individual pulses</p> <p> Note! When entering the pulse width, select a value that can still be processed by an external totalizer (e.g. mechanical totalizer, PLC, etc.).</p> <p> Caution! If the pulse rate resulting from the entered pulse value (see above) and the current flow rate is too large to maintain the selected pulse width (the pause interval P is smaller than the entered pulse width B), a message is generated (# 359/360).</p>

Function description OUTPUTS → PULSE/FREQUENCY OUTPUT 1...2 → CONFIGURATION (impulse)									
<p>MEASURING MODE</p> <p>Modbus register: Pulse/freq. output 1 3228 Pulse/freq. output 2 3428 Data type: Integer Access: read/ write</p>	<p>Use this function to define the measuring mode for the pulse output.</p> <p> Note! Function available only if PULSE or FREQUENCY has been selected in the OPERATION MODE function.</p> <p>Options: 0 = FORWARD 1 = BIDIRECTIONAL 3 = BACKWARD</p> <p>Factory setting: FORWARD</p> <p>Description of the individual options:</p> <p>BALANCE Positive and negative flow rates are output. Only the amount of the flow is relevant for generating the pulses or frequency. If the output is again at the second PULS/FREQ.OUT., the time delay or phase shift is lagging if the flow rate is positive and leading if the flow rate is negative.</p> <p>FORWARD Only positive flow rates are output. Negative flow rates are cut off. If the output is again on the second PULS/FREQ.OUT., the time delay or phase shift is lagging.</p> <p>BACKWARD Only negative flow rates are output. Positive flow rates are cut off. If the output is again on the second PULS/FREQ.OUT., the time delay or phase shift is leading.</p>								
<p>FAILURE SENSITIVITY</p> <p>Modbus register: Pulse/freq. output 1 3254 Pulse/freq. output 2 3454 Data type: Integer Access: read/ write</p>	<p>Defines the message categories to which the output reacts.</p> <p>Options: 0 = OFF = The output does not react to any status. 1 = WARNING = The output reacts to warnings. 2 = ERROR = The output reacts to errors. 3 = ERROR AND WARN. = The output reacts to warnings and notes</p> <p>Factory setting: ERROR</p>								
<p>FAILSAFE MODE</p> <p>Modbus register: Pulse/freq. output 1 3230 Pulse/freq. output 2 3430 Data type: Integer Access: read/ write</p>	<p>Defines how the PULS/FREQ.OUT. behaves when a message occurs of the category to which the PULS/FREQ.OUT. is configured to react.</p> <p> Note! Function is not available unless the PULSE setting was selected in the OPERATION MODE function.</p> <p>Options: 0 = FALLBACK VALUE Output is 0 Hz. 2 = HOLD VALUE Measured value display on the basis of the last measured value preceding occurrence of the message. 4 = HIGH VALUE Output of the highest possible pulse rate or frequency.</p> <p>Factory setting: FALLBACK VALUE</p> <p> Note! If OFF is not selected for 2ND CHANNEL, the failsafe mode of channel 2 is as follows:</p> <table border="1" style="margin-left: auto; margin-right: auto;"> <thead> <tr> <th>1st channel</th> <th>2nd channel</th> </tr> </thead> <tbody> <tr> <td>FALLBACK VALUE</td> <td>HIGH VALUE</td> </tr> <tr> <td>HOLD VALUE</td> <td>HOLD VALUE</td> </tr> <tr> <td>HIGH VALUE</td> <td>FALLBACK VALUE</td> </tr> </tbody> </table>	1st channel	2nd channel	FALLBACK VALUE	HIGH VALUE	HOLD VALUE	HOLD VALUE	HIGH VALUE	FALLBACK VALUE
1st channel	2nd channel								
FALLBACK VALUE	HIGH VALUE								
HOLD VALUE	HOLD VALUE								
HIGH VALUE	FALLBACK VALUE								

Function description OUTPUTS → PULSE/FREQUENCY OUTPUT 1...2 → CONFIGURATION (impulse)	
<p>OUTPUT SIGNAL</p> <p>Modbus register: Pulse/freq. output 1 3229 Pulse/freq. output 2 3429 Data type: Integer Access: read/write</p>	<p>Use this function to select the polarity of the output signal.</p> <p> Note! Function is not available unless the PULSE setting was selected in the OPERATION MODE function.</p> <p>Options: 0 = PASSIVE/POSITIVE 1 = PASSIVE/NEGATIVE</p> <p>Factory setting: PASSIVE/POSITIVE</p> <p>Description of the individual options: PASSIVE/POSITIVE The output transistor is nonconductive during the first half of the output of a pulse and conductive otherwise.</p> <p>PASSIVE/NEGATIVE The output transistor is conductive during the first half of the output of a pulse and nonconductive otherwise.</p>





Function description	
OUTPUTS → PULSE/FREQUENCY OUTPUT 1...2 → CONFIGURATION (status)	
<p>ASSIGN STATUS</p> <p>Modbus register: Pulse/freq. output 1 3236 Pulse/freq. output 2 3436 Data type: Integer Access: read/ write</p>	<p>Use this function to assign a switching function to the status output.</p> <p> Note! Function is not available unless the STATUS setting was selected in the OPERATION MODE function.</p> <p>Options: 0 = OFF → nonconductive 1 = ON → conductive 2 = ERROR → nonconductive if error message is present 3 = WARNING → nonconductive if warning message is present 4 = ERROR AND WARN. → nonconductive if error or warning message is present 6 = FLOW DIRECTION → conductive if flow rate is positive and nonconductive if flow rate is negative</p> <p>Factory setting: ERRORS</p>
<p>ACTUAL STATUS</p> <p>Modbus register: 3248 Data type: Integer Access: read/ write</p>	<p>Use this function to check the current status of the status output.</p> <p> Note! Function is not available unless the STATUS setting was selected in the OPERATION MODE function.</p> <p>Display: 0 = NON CONDUCTIVE 1 = CONDUCTIVE</p>

13.6 Block "BASIC FUNCTION"

13.6.1 Group "Modbus RS485"



Function description BASIC FUNCTION → Modbus RS485 → CONFIGURATION	
<p>TRANSMISSION MODE</p> <p>Modbus register: 4913 Data type: Integer Access: read/write</p>	<p>For selecting the data transfer mode.</p> <p>Options: 0 = RTU 1 = ASCII</p> <p>Factory setting: RTU</p>
<p>BAUDRATE</p> <p>Modbus register: 4912 Data type: Integer Access: read/write</p>	<p>For selecting the baud rate.</p> <p>Options: 0 = 1200 BAUD 1 = 2400 BAUD 2 = 4800 BAUD 3 = 9600 BAUD 4 = 19200 BAUD 5 = 38400 BAUD 6 = 57600 BAUD 7 = 115200 BAUD</p> <p>Factory setting: 19200 BAUD</p>
<p>PARITY</p> <p>Modbus register: 4914 Data type: Integer Access: read/write</p>	<p>For selecting whether no parity bit or an even or uneven parity bit should be transmitted.</p> <p>Options: 0 = EVEN 1 = ODD 2 = NONE/STOP BITS 2 3 = NONE/STOP BITS 1</p> <p>Factory setting: EVEN</p>
<p>DELAY TELEGRAM REPLY</p> <p>Modbus register: 4916 Data type: Float Access: read/write</p>	<p>For entering a minimum delay time after which the measuring device replies to the request telegram of the Modbus master. This allows communication to be adapted to slow Modbus RS485 masters.</p> <p>User input: 0 to 100 ms</p> <p>Factory setting: 10 ms</p>
<p>FIELD BUS ADDRESS</p> <p>Modbus register: 4910 Data type: Integer Access: read/write</p>	<p>For entering the device address.</p> <p>User input: 1 to 247</p> <p>Factory setting: 247</p>

Function description	
BASIC FUNCTION → Modbus RS485 → CONFIGURATION	
<p>BYTEORDER FLOAT</p> <p>Modbus register: 4924 Data type: Integer Access: read/ write</p>	<p>Select the transmission sequence of bytes for the data type Float.</p> <p>Options: 0 = 0 - 1 - 2 - 3 1 = 3 - 2 - 1 - 0 2 = 2 - 3 - 0 - 1 3 = 1 - 0 - 3 - 2</p> <p>Factory setting: 1 - 0 - 3 - 2</p> <p> Note! <ul style="list-style-type: none"> ■ The transmission sequence must suit the Modbus master. ■ For more information, refer to the keyword "Byte transmission sequence", → 23. </p>
<p>BYTEORDER STRING</p> <p>Modbus register: 4922 Data type: Integer Access: read/ write</p>	<p>Select the transmission sequence of bytes for the data type String.</p> <p>Options: 0 = 0 - 1 1 = 1 - 0</p> <p>Factory setting: 1 - 0</p> <p> Note! <ul style="list-style-type: none"> ■ The transmission sequence must suit the Modbus master. ■ For more information, refer to the keyword "Byte transmission sequence", → 23. </p>
<p>BYTEORDER INTEGER</p> <p>Modbus register: 4923 Data type: Integer Access: read/ write</p>	<p>Select the transmission sequence of bytes for the data type Integer.</p> <p>Options: 0 = 0 - 1 1 = 1 - 0</p> <p>Factory setting: 1 - 0</p> <p> Note! <ul style="list-style-type: none"> ■ The transmission sequence must suit the Modbus master. ■ For more information, refer to the keyword "Byte transmission sequence", → 23. </p>
<p>TAG NAME</p> <p>Modbus register: 4901 Data type: String (16) Access: read/ write</p>	<p>For entering a tag name for the measuring device.</p> <p>User input: max. 15-character text, permissible: A-Z, 0-9, +, -, punctuation marks</p> <p>Factory setting: " _ _ _ _ _ _ _ _ _ _ _ _ _ _ _ _ " (No text)</p> <p> Note! For the Modbus, the input must end with the termination (binary null).</p>
<p>FAILURE SENSITIVITY</p> <p>Modbus register: 4921 Data type: Integer Access: read/ write</p>	<p>Defines the message categories to which the data transmission reacts.</p> <p>Options: 0 = OFF = The data transmission does not react to any messages. 1 = WARNING = The data transmission reacts to warnings. 2 = ERROR = The data transmission reacts to errors. 3 = ERROR AND WARN. = The data transmission reacts to errors and warnings</p> <p>Factory setting: ERROR</p>

Function description BASIC FUNCTION → Modbus RS485 → CONFIGURATION	
<p>FAILSAFE MODE</p> <p>Modbus register: 4920 Data type: Integer Access: read/write</p>	<p>Defines how the measured value output behaves when a message occurs of the category to which it is configured to react.</p> <p>Options: 0 = STOP = The data transmission returns "NaN" 1 = HOLD VALUE = The data transmission returns the last value before the message occurred.</p> <p>Factory setting: STOP</p>
<p>INTERPRETER MODE</p> <p>Modbus Register: 4925 Datentyp: Integer Access: read/write</p>	<p>Defines how the interpreter of telegram receipt behaves.</p> <p>Options: 0 = STANDARD = Behavior in accordance with Modbus standard, i.e. the two last received bytes are the check sum CRC16. 1 = IGNORE SURPLUS BYTES = the two bytes for the check sum CRC16 are determined from the telegram length which can be expected, if possible from the function code. Surplus bytes at the end of the actual telegram are ignored. This behavior does not correspond to the Modbus standard.</p> <p>Factory setting: STANDARD</p> <p> Note! The selection has only a meaning in the RTU mode. In the ASCII mode the equipment always behaves in accordance with the Modbus standard.</p>

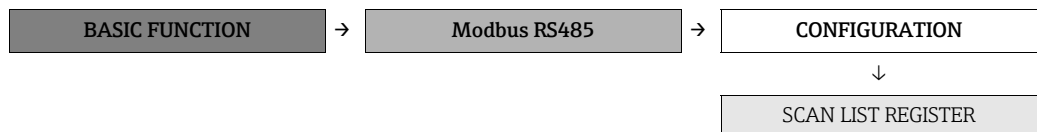



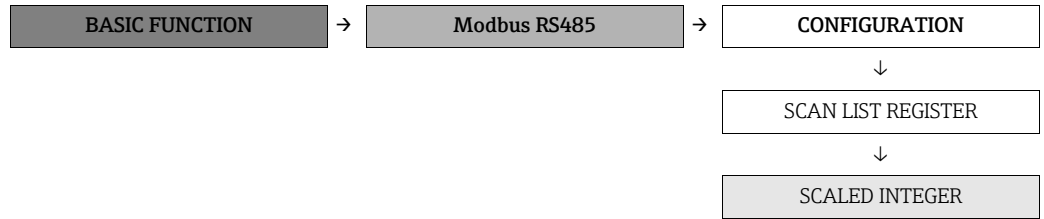



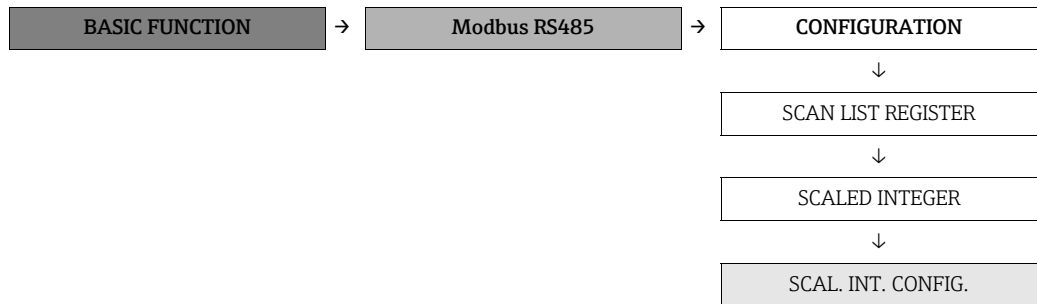







Function description BASIC FUNCTION → PROCESSPARAMETER → SCAN LIST REGISTER	
<p>SCAN LIST REGISTER 1 TO 16</p> <p>Modbus register: SCAN LIST REG. 1 5001 SCAN LIST REG. 2 5002 SCAN LIST REG. 3 5003 SCAN LIST REG. 4 5004 SCAN LIST REG. 5 5005 SCAN LIST REG. 6 5006 SCAN LIST REG. 7 5007 SCAN LIST REG. 8 5008 SCAN LIST REG. 9 5009 SCAN LIST REG. 10 5010 SCAN LIST REG. 11 5011 SCAN LIST REG. 12 5012 SCAN LIST REG. 13 5013 SCAN LIST REG. 14 5014 SCAN LIST REG. 15 5015 SCAN LIST REG. 16 5016 Data type: Integer Access: read/write</p>	<p>By entering the register address (1-based), up to 16 device parameters can be grouped in the auto-scan buffer where they are assigned to the scan list registers 1 to 16. The data of the device parameters assigned here are read out via the register addresses 5051 to 5081.</p> <p>User input: 1 to 65535</p> <p>Factory setting: 1</p>





Function description	
BASIC FUNCTION → PROCESSPARAMETER → SCALED INTEGER	
<p>MASS FLOW</p> <p>Modbus register: 2 Data type: Integer Access: read</p>	<p>This function shows the current measured mass flow as scaled integer.</p> <p> Note! Details for scaling → 29.</p>
<p>DENSITY</p> <p>Modbus register: 3 Data type: Integer Access: read</p>	<p>This function shows the current measured density as scaled integer.</p> <p> Note! Details for scaling → 29.</p>
<p>TEMPERATURE</p> <p>Modbus register: 4 Data type: Integer Access: read</p>	<p>This function shows the current measured temperature as scaled integer.</p> <p> Note! Details for scaling → 29.</p>
<p>VOLUME FLOW</p> <p>Modbus register: 5 Data type: Integer Access: read</p>	<p>This function shows the calculated volume flow as scaled integer.</p> <p> Note! Details for scaling → 29.</p>
<p>PRESSURE</p> <p>Modbus register: 7 Data type: Integer Access: read</p>	<p>This function shows the adjusted pressure as scaled integer.</p> <p> Note! Details for scaling → 29.</p>
<p>TOTALIZER</p> <p>Modbus register: TOTALIZER 1: 8 TOTALIZER 2: 9 Data type: Integer Access: read</p>	<p>This function shows the value of the totalizer as scaled integer.</p> <p> Note! The totalizer 1 must be assigned on mass flow, the totalizer 2 on volume flow. Details for scaling → 29.</p>



Function description BASIC FUNCTION → PROCESSPARAMETER → SCALED INTEGER CONFIGURATION	
<p>MAX. INTEGER</p> <p>Modbus register: 18 Data type: Integer Access: read/write</p>	<p>Input of the general maximum integer value for the scaling.</p> <p>User input: 0 to 65534 Factory settings: 65534</p> <p> Note! Details for scaling → 29.</p>
<p>FACTOR MASS FLOW</p> <p>Modbus register: 29 Data type: Integer Access: read/write</p>	<p>Input of the factor of the scaled integer for the mass flow.</p> <p>User input: 0 to 65535 Factory settings: 1</p> <p> Note! Details for scaling → 29.</p>
<p>OFFSET MASS FLOW</p> <p>Modbus register: 19 Data type: Integer Access: read/write</p>	<p>Input of the offset of the scaled integer for the mass flow.</p> <p>User input: 0 to 65536 Factory setting: 32768</p> <p> Note! Details for scaling → 29.</p>
<p>FACTOR DENSITY</p> <p>Modbus register: 30 Data type: Integer Access: read/write</p>	<p>Input of the factor of the scaled integer for the density.</p> <p>User input: 0 to 65536 Factory setting: 1</p> <p> Note! Details for scaling → 29.</p>
<p>OFFSET DENSITY</p> <p>Modbus register: 20 Data type: Integer Access: read/write</p>	<p>Input of the offset of the scaled integer for the density.</p> <p>User input: 0 to 65535 Factory setting: 32768</p> <p> Note! Details for scaling → 29.</p>

Function description	
BASIC FUNCTION → PROCESSPARAMETER → SCALED INTEGER CONFIGURATION	
<p>FACTOR TEMPERATURE</p> <p>Modbus register: 31 Data type: Integer Access: read/write</p>	<p>Input of the factor of the scaled integer for the temperature.</p> <p>User input: 0 to 65536 Factory setting: 1</p> <p> Note! Details for scaling →  29.</p>
<p>OFFSET TEMPERATURE</p> <p>Modbus register: 21 Data type: Integer Access: read/write</p>	<p>Input of the offset of the scaled integer for the temperature.</p> <p>User input: 0 to 65535 Factory setting: 32736</p> <p> Note! Details for scaling →  29.</p>
<p>FACTOR VOLUME FLOW</p> <p>Modbus register: 32 Data type: Integer Access: read/write</p>	<p>Input of the factor of the scaled integer for the volume flow.</p> <p>User input: 0 to 65536 Factory setting: 1</p> <p> Note! Details for scaling →  29.</p>
<p>OFFSET VOLUME FLOW</p> <p>Modbus register: 22 Data type: Integer Access: read/write</p>	<p>Input of the offset of the scaled integer for the volume flow.</p> <p>User input: 0 to 65535 Factory setting: 32738</p> <p> Note! Details for scaling →  29.</p>
<p>FACTOR PRESSURE</p> <p>Modbus register: 34 Data type: Integer Access: read/write</p>	<p>Input of the factor of the scaled integer for the pressure.</p> <p>User input: 0 to 65536 Factory setting: 1</p> <p> Note! Details for scaling →  29.</p>
<p>OFFSET PRESSURE</p> <p>Modbus register: 24 Data type: Integer Access: read/write</p>	<p>Input of the offset of the scaled integer for the pressure.</p> <p>User input: 0 to 65535 Factory setting: 32738</p> <p> Note! Details for scaling →  29.</p>
<p>FACTOR TOTALIZER</p> <p>Modbus register: 35 Data type: Integer Access: read/write</p>	<p>Input of the factor of the scaled integer for the totalizer status.</p> <p>User input: 0 to 65536 Factory setting: 1</p> <p> Note! The totalizer 1 must be assigned on mass flow, the totalizer 2 on volume flow. Details for scaling →  29.</p>

Function description BASIC FUNCTION → PROCESSPARAMETER → SCALED INTEGER CONFIGURATION	
OFFSET TOTALIZER Modbus register: Data type: 25 Access: 26 Integer read/write	Input of the offset of the scaled integer for the totalizer status. User input: 0 to 65535 Factory setting: 32738  Note! The totalizer 1 must be assigned on mass flow, the totalizer 2 on volume flow. Details for scaling →  29.

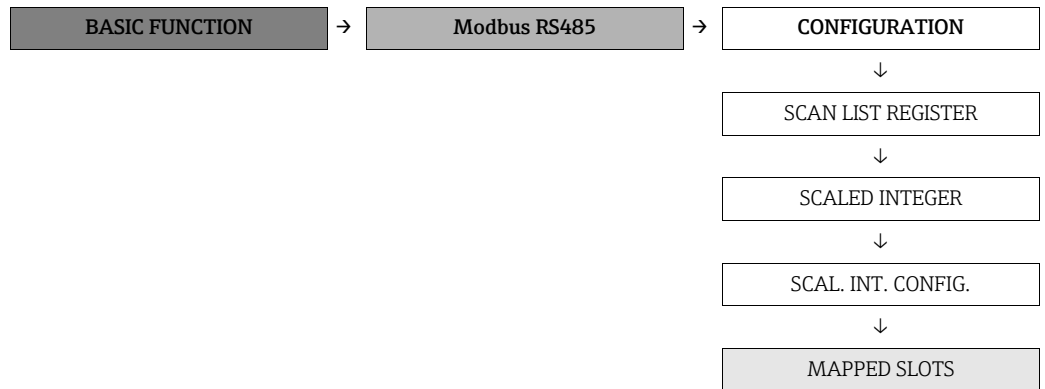

Function description																																																																	
BASIC FUNCTION → PROCESSPARAMETER → SCALED INTEGER CONFIGURATION																																																																	
<p>SLOT 1 to 32</p> <p>Modbus register:</p> <table border="0"> <tr><td>Slot 1:</td><td>655</td></tr> <tr><td>Slot 2:</td><td>656</td></tr> <tr><td>Slot 3:</td><td>657</td></tr> <tr><td>Slot 4:</td><td>658</td></tr> <tr><td>Slot 5:</td><td>659</td></tr> <tr><td>Slot 6:</td><td>660</td></tr> <tr><td>Slot 7:</td><td>661</td></tr> <tr><td>Slot 8:</td><td>662</td></tr> <tr><td>Slot 9:</td><td>663</td></tr> <tr><td>Slot 10:</td><td>664</td></tr> <tr><td>Slot 11:</td><td>665</td></tr> <tr><td>Slot 12:</td><td>666</td></tr> <tr><td>Slot 13:</td><td>667</td></tr> <tr><td>Slot 14:</td><td>668</td></tr> <tr><td>Slot 15:</td><td>669</td></tr> <tr><td>Slot 16:</td><td>670</td></tr> <tr><td>Slot 17:</td><td>671</td></tr> <tr><td>Slot 18:</td><td>672</td></tr> <tr><td>Slot 19:</td><td>673</td></tr> <tr><td>Slot 20:</td><td>674</td></tr> <tr><td>Slot 21:</td><td>675</td></tr> <tr><td>Slot 22:</td><td>676</td></tr> <tr><td>Slot 23:</td><td>677</td></tr> <tr><td>Slot 24:</td><td>678</td></tr> <tr><td>Slot 25:</td><td>679</td></tr> <tr><td>Slot 26:</td><td>680</td></tr> <tr><td>Slot 27:</td><td>681</td></tr> <tr><td>Slot 28:</td><td>682</td></tr> <tr><td>Slot 29:</td><td>683</td></tr> <tr><td>Slot 30:</td><td>684</td></tr> <tr><td>Slot 31:</td><td>685</td></tr> <tr><td>Slot 32:</td><td>686</td></tr> </table> <p>Data type: Integer Access: read/ write</p>	Slot 1:	655	Slot 2:	656	Slot 3:	657	Slot 4:	658	Slot 5:	659	Slot 6:	660	Slot 7:	661	Slot 8:	662	Slot 9:	663	Slot 10:	664	Slot 11:	665	Slot 12:	666	Slot 13:	667	Slot 14:	668	Slot 15:	669	Slot 16:	670	Slot 17:	671	Slot 18:	672	Slot 19:	673	Slot 20:	674	Slot 21:	675	Slot 22:	676	Slot 23:	677	Slot 24:	678	Slot 25:	679	Slot 26:	680	Slot 27:	681	Slot 28:	682	Slot 29:	683	Slot 30:	684	Slot 31:	685	Slot 32:	686	<p>By the input of the register address (based on 0) up to 32 equipment parameters can be grouped. The readout of the data is made by the register addresses 687/688 for Slot 1, 689/690 for Slot 2 etc. up to 749/750 for Slot 32.</p> <p>User input: 0 to 65535</p> <p>Factory setting: 0</p> <p> Note! For the readout of the data always two registers are reserved, if the value has the data type floating POINT and thus two registers occupied.</p>
Slot 1:	655																																																																
Slot 2:	656																																																																
Slot 3:	657																																																																
Slot 4:	658																																																																
Slot 5:	659																																																																
Slot 6:	660																																																																
Slot 7:	661																																																																
Slot 8:	662																																																																
Slot 9:	663																																																																
Slot 10:	664																																																																
Slot 11:	665																																																																
Slot 12:	666																																																																
Slot 13:	667																																																																
Slot 14:	668																																																																
Slot 15:	669																																																																
Slot 16:	670																																																																
Slot 17:	671																																																																
Slot 18:	672																																																																
Slot 19:	673																																																																
Slot 20:	674																																																																
Slot 21:	675																																																																
Slot 22:	676																																																																
Slot 23:	677																																																																
Slot 24:	678																																																																
Slot 25:	679																																																																
Slot 26:	680																																																																
Slot 27:	681																																																																
Slot 28:	682																																																																
Slot 29:	683																																																																
Slot 30:	684																																																																
Slot 31:	685																																																																
Slot 32:	686																																																																

13.6.2 Group "PROCESSPARAMETER"

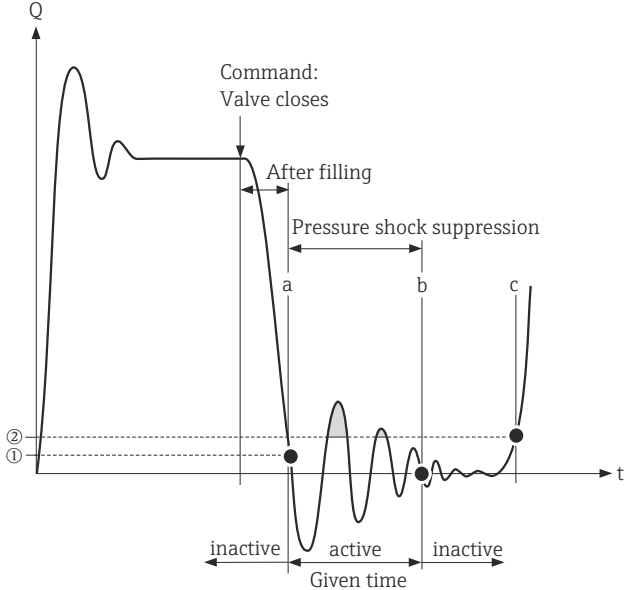

Function description BASIC FUNCTION → PROCESSPARAMETER → CONFIGURATION	
<p>ASSIGN LOW FLOW-CUTOFF</p> <p>Modbus register: 5101 Data type: Integer Access: read/write</p>	<p>Use this function to assign the measured variable to which the low flow cut off pertains.</p> <p>Options: 1 = MASS FLOW 2 = VOLUME FLOW</p> <p>Factory setting: MASS FLOW</p>
<p>ON-VALUE LOW FLOW-CUTOFF</p> <p>Modbus register: 5138 Data type: Float Access: read/write</p>	<p>Use this function to assign a value to the switch-on point for low flow cut off.</p> <p>Low flow cut off is active if the value entered is not equal to 0.</p> <p>User input: Floating-point number</p> <p>Factory setting: Depends on nominal diameter</p> <p> Note! The switch-off point for low flow cut off is implicit 150% of the switch-on point for low flow cut off. Therefore the low flow cut off features a hysteresis.</p>

Function description BASIC FUNCTION → PROCESSPARAMETER → CONFIGURATION	
<p>PRESSURE SHOCK SUPPRESSION</p> <p>Modbus register: 5140 Data type: Float Access: read/write</p>	<p>The closure of a valve can cause brief but severe movements of the fluid which the measuring system registers. For this reason, the measuring device is equipped with pressure shock suppression (= short-term signal suppression) which can eliminate system-related "disruptions".</p> <p> Note! Note that pressure shock suppression cannot be used unless the low flow cut off is active, (see function ON-VAL.LF-CUTOFF → 86). Use this function to define the time span for active pressure shock suppression.</p> <p>Activation of the pressure shock suppression Pressure shock suppression is activated after the flow falls below the switch-on point of the low flow cut off (see point a in graphic). When pressure shock suppression is activated, the flow is set to null.</p> <p>Deactivation of the pressure shock suppression The pressure shock suppression is deactivated after the time interval, set in this function, has passed (see point b in graphic). The actual flow value is not displayed and output until the specified time interval for the pressure shock suppression has passed and the flow exceeds the switch-off point of the low flow cut off (see point c in the graphic)</p> <div style="text-align: center;">  </div> <p style="text-align: right; font-size: small;">A0001285-en</p> <p>Fig. 23: Pressure shock suppression</p> <ul style="list-style-type: none"> ① On-value (creepage) ② Off-value (creepage) a Active when value falls below the on-value of the low flow cut off b Deactivated after specified time expires c Flow values are again used to calculate the pulses n Suppressed values Q Flow <p>User input: 0.00 to 10.0 s</p> <p>Factory setting: 0.00 s</p>

Function description BASIC FUNCTION → PROCESSPARAMETER → CONFIGURATION	
<p>EPD VALUE LOW</p> <p>Modbus register: 5110 Data type: Float Access: read/write</p>	<p>Use this function to set a lower threshold for the measured density value. If the value falls below this threshold, the measuring tube is considered empty. Message #700 appears.</p> <p>User input: Floating-point number</p> <p>Factory setting: 0 kg/l or 0 g/cc</p>
<p>EPD RESPONSETIME</p> <p>Modbus register: 5108 Data type: Float Access: read/write</p>	<p>Use this function to define a time span for which the activation criterion for an error has to be satisfied without interruption before the function is activated.</p> <p>User input: 0 to 100 s</p> <p>Factory setting: 1.0 s</p>

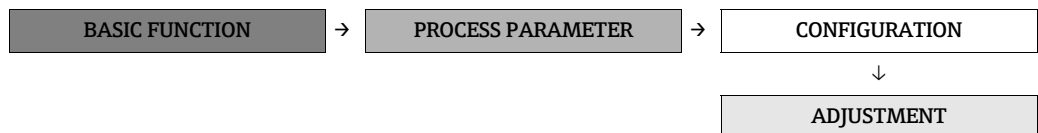

Function description BASIC FUNCTION → PROCESSPARAMETER → ADJUSTMENT	
<p>ZEROPOINT ADJUST</p> <p>Modbus register: 5121 Data type: Integer Access: read/write</p>	<p>This function enables a zero point adjustment to be carried out. The new zero point determined by the measuring system is adopted by the function ZEROPOINT.</p> <p>Options: 0 = CANCEL 1 = START 2 = ERROR</p> <p>Factory setting: CANCEL</p> <p> Caution! Before carrying this out, please refer to the detailed description of the procedure for a zero point adjustment → 31.</p>
<p>ZEROPOINT</p> <p>Modbus register: 7527 Data type: Float Access: read/write</p>	<p>This function shows the current zero point correction value for the sensor.</p> <p>Display: max. 5-digit number: -99999 to +99999</p> <p>Factory setting: Depends on calibration</p>
<p>PROGRESS</p> <p>Modbus register: 6797 Data type: Integer Access: read/write</p>	<p>Displays the progress of a zero point adjustment as a percentage of the duration.</p> <p>Display: 0 to 100%</p>

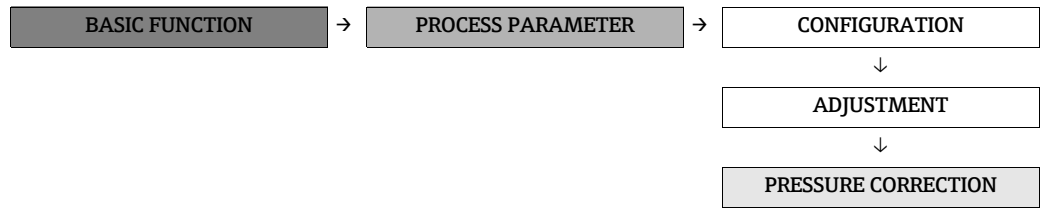

Function description BASIC FUNCTION → PROCESSPARAMETER → PRESSURE CORRECTION	
<p>PRESSURE MODE</p> <p>Modbus register: 5184 Data type: Integer Access: read/write</p>	<p>Use this function to configure an automatic pressure correction. In this way, the effect of a pressure deviation between the calibration and process pressures on the measured error for mass flow is compensated for (see the chapter on "Performance characteristics", → 48).</p> <p>Options: 0 = OFF 1 = ON (a fixed process pressure for pressure correction is specified).</p> <p>Factory setting: OFF</p> <p> Note! Measuring cells in which the pressure has only a negligible effect on the accuracy do not need this correction.</p>
<p>PRESSURE</p> <p>Modbus register: 5185 Data type: Float Access: read/write</p>	<p>Use this function to enter the value for the process pressure which should be used during pressure correction.</p> <p> Note! Function is not available unless the ON selection was selected in the PRESSURE MODE function.</p> <p>User input: Floating-point number</p>

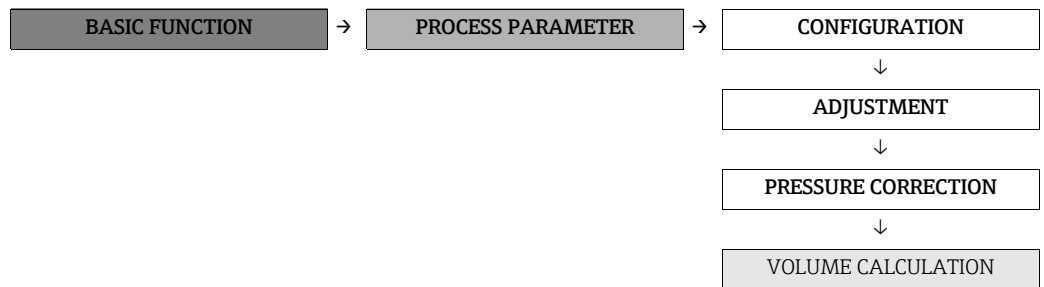



Function description BASIC FUNCTION → PROCESSPARAMETER → VOLUME CALCULATION	
<p>VOLUME CALCULATION</p> <p>Modbus register: 5052 Data type: Integer Access: read/write</p>	<p>Use this function to select the type of volume calculation.</p> <p>Options: 0 = MEASURED DENSITY (the density measured by the device is used) 1 = FIXED DENSITY (a fixed density is specified, e.g. if the fluid is known)</p> <p>Factory setting: FIXED DENSITY</p>
<p>FIXED DENSITY</p> <p>Modbus register: 5130 Data type: Float Access: read/write</p>	<p>Use this function to specify a fixed density of the fluid.</p> <p>Factory setting: 0.0008 kg/l (typical value for compressed natural gas)</p> <p>User input: Floating-point number</p>

13.6.3 Group "SYSTEM PARAMETER"



Function description BASIC FUNCTION → SYSTEM PARAMETER → CONFIGURATION	
<p> Caution! The settings configured under these functions are used by the verification official to adjust the individual measured values. These settings cannot be modified after the device has been sealed. Changing these values when not in custody transfer mode can potentially cause measured values to be incorrect and is therefore not recommended.</p>	
<p>INSTALLATION DIRECTION SENSOR</p> <p>Modbus register: 5501 Data type: Integer Access: read/write</p>	<p>Use this function to reverse the sign of the flow direction, if necessary.</p> <p>Options: 0 = FORWARD (flow in direction of arrow) 1 = REVERSE (flow reverse to direction of arrow)</p> <p>Factory setting: NORMAL</p>
<p>FLOW DAMPING</p> <p>Modbus register: 5510 Data type: Float Access: read/write</p>	<p>For setting the damping of the mass flow measured value. It can be used to reduce the spread. The reaction time of the measuring device increases with every increase in the damping. The damping acts on all functions and outputs of the measuring device.</p> <p>User input: 0 to 100 s Factory setting: 0.1 s</p>
<p>M. FACTOR MASS FLOW</p> <p>Modbus register: 5519 Data type: Float Access: read/write</p>	<p>Use this function to enter the factor for adjustment of the mass flow.</p> <p>User input: Floating-point number Factory setting: 1</p>
<p>M. OFFSET MASSFLOW</p> <p>Modbus register: 5521 Data type: Float Access: read/write</p>	<p>Use this function to enter the offset for adjustment of the mass flow.</p> <p>User input: Floating-point number Factory setting: 0</p>
<p>M. FACTOR VOLUMEFLOW</p> <p>Modbus register: 5523 Data type: Float Access: read/write</p>	<p>Use this function to enter the factor for adjustment of the volume flow.</p> <p>User input: Floating-point number Factory setting: 1</p>
<p>M. OFFSET VOLUME FLOW</p> <p>Modbus register: 5525 Data type: Float Access: read/write</p>	<p>Use this function to enter the offset for adjustment of the volume flow.</p> <p>User input: Floating-point number Factory setting: 0</p>
<p>M. FACTOR DENSITY</p> <p>Modbus register: 5527 Data type: Float Access: read/write</p>	<p>Use this function to enter the factor for adjustment of the density.</p> <p>User input: Floating-point number Factory setting: 1</p>

Function description BASIC FUNCTION → SYSTEM PARAMETER → CONFIGURATION	
<p>M. OFFSET DENSITY</p> <p>Modbus register: 5529 Data type: Float Access: read/write</p>	<p>Use this function to enter the offset for adjustment of the density.</p> <p>User input: Floating-point number</p> <p>Factory setting: 0</p>
<p>M. FACTOR TEMPERATURE</p> <p>Modbus register: 5531 Data type: Float Access: read/write</p>	<p>Use this function to enter the factor for adjustment of the temperature.</p> <p>User input: Floating-point number</p> <p>Factory setting: 1</p> <p> Note! The value entered relates to the absolute temperature in Kelvin. Example: - current temperature = 26.85 °C equals 300 Kelvin - if you enter a value of 1.01 the temperatur changes thus to 303 Kelvin. This equals 29.85 °C.</p>
<p>M. OFFSET TEMPERATURE</p> <p>Modbus register: 5533 Data type: Float Access: read/write</p>	<p>Use this function to enter the offset for adjustment of the temperature.</p> <p>User input: Floating-point number</p> <p>Factory setting: 0</p> <p> Note! The value entered shows always the unit Kelvin. Example: - actual temperature = 26.85 °C equals 300 Kelvin - if you enter a value of 1 the temperatur changes thus to 301 Kelvin. This equals 27.85 °C.</p>

13.6.4 Group "SENSOR DATA"



Function description BASIC FUNCTION → SENSOR DATA → CONFIGURATION	
<p>K-FACTOR</p> <p>Modbus register: 7513 Data type: Float Access: Read</p>	<p>This function shows the calibration factor for the sensor.</p>
<p>ZEROPOINT</p> <p>Modbus register: 7527 Data type: Float Access: read/write</p>	<p>Shows the zero point for the sensor.</p>
<p>NOMINAL DIAMETER</p> <p>Modbus register: 7525 Data type: Integer Access: Read</p>	<p>This function shows the nominal diameter for the sensor.</p> <p>Display: 8 = DN15 11 = DN25</p>

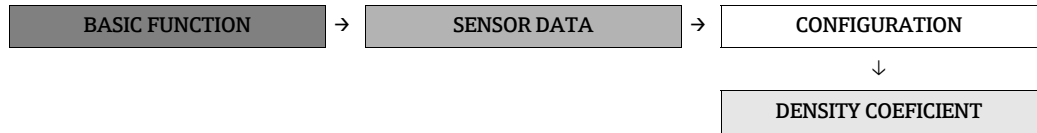

Function description BASIC FUNCTION → SENSOR DATA → DENSITY COEFFICIENT	
C0 Modbus register: 7501 Data type: Float Access: Read	Displays the density coefficient C0.
C1 Modbus register: 7503 Data type: Float Access: Read	Displays the density coefficient C1.
C2 Modbus register: 7505 Data type: Float Access: Read	Displays the density coefficient C2.
C3 Modbus register: 7507 Data type: Float Access: Read	Displays the density coefficient C3.
C4 Modbus register: 7509 Data type: Float Access: Read	Displays the density coefficient C4.
C5 Modbus register: 7511 Data type: Float Access: Read	Displays the density coefficient C5.

13.7 Block "SUPERVISION"

13.7.1 Group "SYSTEM"

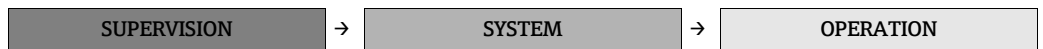

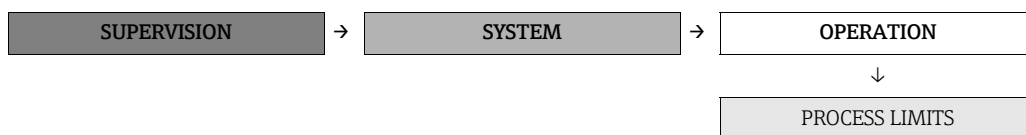

Function description SUPERVISION → SYSTEM → OPERATION	
<p>ACTUAL SYSTEM CONDITION</p> <p>Modbus register: 6801 Data type: Integer Access: Read</p>	<p>Displays the present system condition.</p> <p>Display: 0 = "SYSTEM OK" or Displays the message with the highest priority.</p> <p> Note! The number of the message is output via Modbus RS485, → 40.</p>
<p>OPERATION HOURS</p> <p>Modbus register: 6810 Data type: Float Access: Read</p>	<p>Displays the operating hours of the device.</p> <p>Display:</p> <ul style="list-style-type: none"> ▪ Hours of operation < 10 hours → display format = 0:00:00 (hr:min:sec) ▪ Hours of operation 10 to 10,000 hours → display format = 0000:00 (hr:min) ▪ Hours of operation > 10,000 hours → display format = 000000 (hr)
<p>PROGRAM CODE CRC</p> <p>Modbus register: 8933 Data type: String Access: Read</p>	<p>Display of the CRC checksum of the program code.</p> <p> Note! The CRC checksum is calculated cyclically to verify its consistency.</p>
<p>SYSTEM RESET</p> <p>Modbus register: 6817 Data type: Integer Access: read/write</p>	<p>Use this function to perform a reset of the measuring system.</p> <p>Options: 0 = CANCEL 1 = RESTART SYSTEM (restart without interrupting power supply) 2 = RESET DELIVERY</p> <p>Factory setting: CANCEL</p> <p> Note! Setting back parameters can require several minutes, followed by a start-up of the device. The power supply must not be switched off while the factory settings are being restored.</p>
<p>PROGRESS</p> <p>Modbus register: 6797 Data type: Integer Access: Read</p>	<p>Displays the progress of restoring the default values.</p> <p>Display: 0 to 100%</p>

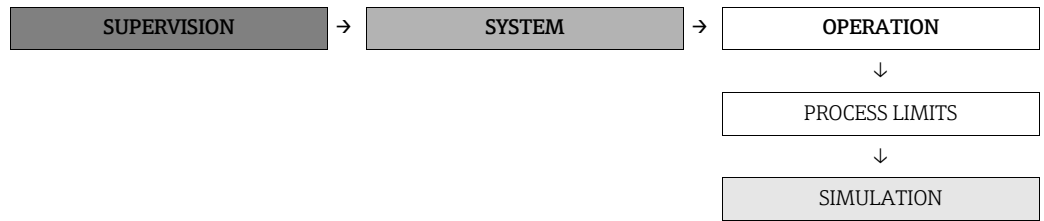

Function description SUPERVISION → SYSTEM → PROCESS LIMITS	
LOWER LIMIT MASSFLOW Modbus register: 6781 Data type: Float Access: read/write	Use this function to enter the lower process limit for the mass flow. If value falls below this limit, message #805 is output. User input: Floating-point number Factory setting: depends on nominal diameter and country
UPPER LIMIT MASSFLOW Modbus register: 6783 Data type: Float Access: read/write	Use this function to enter the upper process limit for the mass flow. If value exceeds this limit, message #806 is output. User input: Floating-point number Factory setting: depends on nominal diameter and country
LOWER LIMIT VOLUMEFLOW Modbus register: 6785 Data type: Float Access: read/write	Use this function to enter the lower process limit for the volume flow. If value falls below this limit, message #807 is output. User input: Floating-point number Factory setting: depends on nominal diameter and country
UPPER LIMIT VOLUMEFLOW Modbus register: 6787 Data type: Float Access: read/write	Use this function to enter the upper process limit for the volume flow. If value exceeds this limit, message #808 is output. User input: Floating-point number Factory setting: depends on nominal diameter and country
LOWER LIMIT TEMPERATURE Modbus register: 6789 Data type: Float Access: read/write	Use this function to enter the lower process limit for the temperature. If value falls below this limit, message #801 is output. User input: Floating-point number Factory setting: -55 °C or -67 °F
UPPER LIMIT TEMPERATURE Modbus register: 6791 Data type: Float Access: read/write	Use this function to enter the upper process limit for the temperature. If value exceeds this limit, message #802 is output. User input: Floating-point number Factory setting: +130 °C or +266 °F
LOWER LIMIT DENSITY Modbus register: 6793 Data type: Float Access: read/write	Use this function to enter the lower process limit for the pressure. If value falls below this limit, message #803 is output. User input: Floating-point number Factory setting: 0 kg/l or 0 g/cc
UPPER LIMIT DENSITY Modbus register: 6795 Data type: Float Access: read/write	Use this function to enter the upper process limit for the density. If value exceeds this limit, message #804 is output. User input: Floating-point number Factory setting: 4 kg/l or 4 g/cc



Function description SUPERVISION → SYSTEM → SIMULATION	
<p>SIMULATION MEASURAND</p> <p>Modbus register: 6813 Data type: Integer Access: read/write</p>	<p>Use this function to set the inputs, outputs and totalizers to their corresponding defined flow-response modes in order to check whether they respond correctly. During this time, message #692, "SIM. MEASURAND", is displayed.</p> <p>Options: 0 = OFF 1 = MASS FLOW 2 = VOLUME FLOW 4 = DENSITY 6 = TEMPERATURE</p> <p>Factory setting: OFF</p> <p> Caution! <ul style="list-style-type: none"> ■ The measuring device cannot be used for measuring while this simulation is in progress. ■ The setting is not saved in the event of a power failure. </p>
<p>VALUE SIMULATION MEASURAND</p> <p>Modbus register: 6814 Data type: Float Access: read/write</p>	<p>For entering a user-selectable value (e.g. 30 kg/min) to check the associated functions in the device itself and downstream signal loops.</p> <p> Note! This function is not available unless the function SIM. MEASURAND is active.</p> <p>User input: Floating-point number</p> <p>Factory setting: 0</p> <p> Caution! The setting is not saved in the event of a power failure.</p>

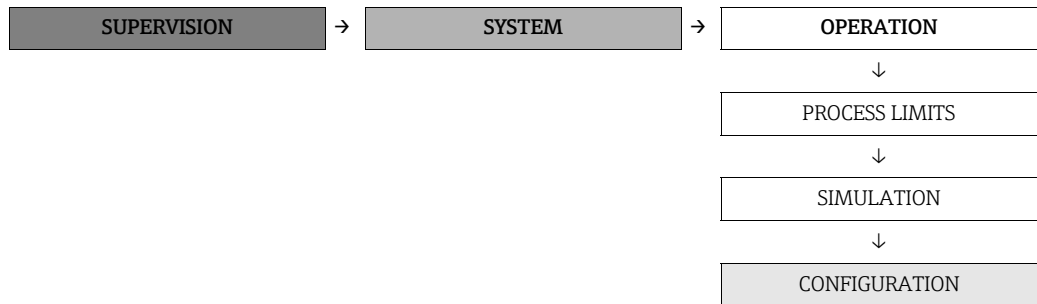

Function description SUPERVISION → SYSTEM → CONFIGURATION	
<p>ALARM DELAY</p> <p>Modbus register: 6808 Data type: Float Access: read/write</p>	<p>Enter a time span for which the criteria for an error have to be satisfied without interruption before a message is generated.</p> <p>User input: 0 to 100 s (in one-second increments)</p> <p>Factory setting: 0 s</p> <p> Caution! If this function is activated, fault and notice messages are delayed by the time corresponding to the setting before being transmitted to the higher-order controller (process controller, etc.). It is therefore imperative to check in advance in order to make sure whether a delay of this nature could affect the safety requirements of the process. If fault and notice messages may not be delayed, a value of 0 seconds must be entered here.</p>
<p>PERMANENT STORAG</p> <p>Modbus register: 6907 Data type: Integer Access: read/write</p>	<p>Enter whether permanent storage of all parameters in the DAT has been switched on or off.</p> <p>Options: 0 = OFF 1 = ON</p> <p>Factory setting: ON</p> <p>Description of the individual options:</p> <p>OFF Changes of settings are not stored permanently. After a power failure, the settings are the same as they were before OFF was selected. This function is recommended if a setting is frequently changed via Modbus, as the number of write actions to the DAT allowed is limited to 1,000,000.</p> <p>ON Every change of the settings is stored permanently. After selecting ON, the measuring instrument carries out a restart and then has the same settings as before OFF was selected.</p>

13.7.2 Group "VERSION-INFO"

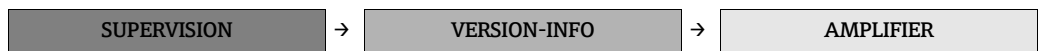

Function description SUPERVISION → VERSION-INFO → AMPLIFIER	
SOFTWARE-REVISION AMPLIFIER Modbus register: 7039 Data type: String Access: (16) Read	Use this function to view the software revision number of the amplifier.

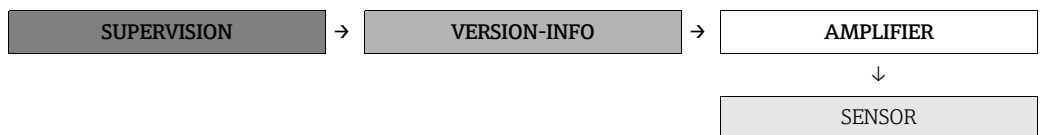

Function description SUPERVISION → VERSION-INFO → SENSOR	
SERIAL NUMBER Modbus register: 7003 Data type: String Access: (16) Read	Displays the serial number of the device.
SENSOR TYPE Modbus register: 7012 Data type: String Access: (16) Read	Displays the sensor type.
SOFTWARE-REVISION DAT Modbus register: 7021 Data type: String Access: (16) Read	Use this function to view the software revision number of the software used to program the DAT.

13.7.3 Group "MESSAGE CATEGORY"

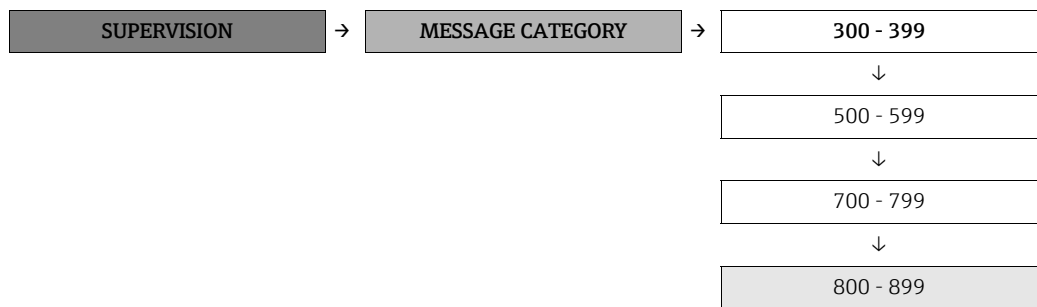
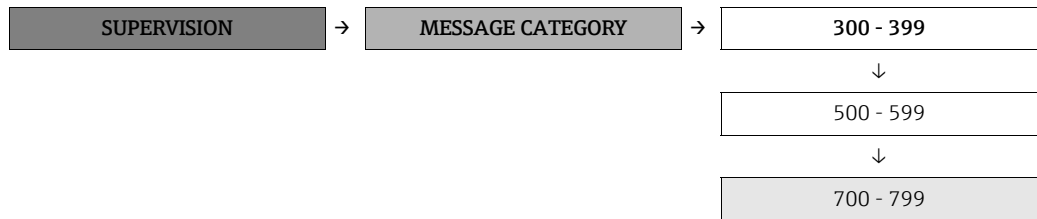
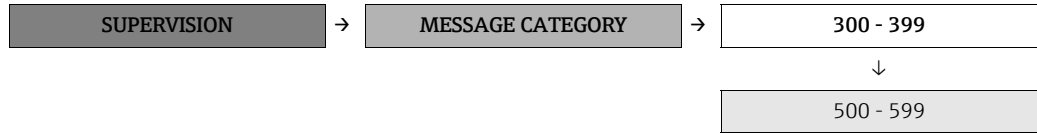

Function description																																									
SUPERVISION → MESSAGE CATEGORY → 300 TO 899																																									
<p>300 to 899</p> <p>Modbus register:</p> <table border="0"> <tr><td>355</td><td>10038</td></tr> <tr><td>356</td><td>10039</td></tr> <tr><td>358</td><td>10041</td></tr> <tr><td>359</td><td>10042</td></tr> <tr><td>360</td><td>10043</td></tr> <tr><td>361</td><td>10044</td></tr> <tr><td>362</td><td>10045</td></tr> <tr><td>379</td><td>10026</td></tr> <tr><td>380</td><td>10027</td></tr> <tr><td>381</td><td>10028</td></tr> <tr><td>382</td><td>10029</td></tr> <tr><td>383</td><td>10030</td></tr> <tr><td>384</td><td>10031</td></tr> <tr><td>385</td><td>10032</td></tr> <tr><td>386</td><td>10033</td></tr> <tr><td>387</td><td>10034</td></tr> <tr><td>388</td><td>10070</td></tr> <tr><td>389</td><td>10071</td></tr> <tr><td>586</td><td>10035</td></tr> <tr><td>587</td><td>10036</td></tr> </table>	355	10038	356	10039	358	10041	359	10042	360	10043	361	10044	362	10045	379	10026	380	10027	381	10028	382	10029	383	10030	384	10031	385	10032	386	10033	387	10034	388	10070	389	10071	586	10035	587	10036	<p>Set the category of a message.</p> <p>Options: 0 = OFF = No status is activated. 1 = WARNING = The status in the "Warning" category. 2 = ERROR = The status is in the "Error" category.</p> <p>Factory setting: 300 to 399 = ERROR 500 to 599 = ERROR 700 to 799 = Note 800 = Note 801 to 899 = OFF</p> <p>(continued on next page)</p>
355	10038																																								
356	10039																																								
358	10041																																								
359	10042																																								
360	10043																																								
361	10044																																								
362	10045																																								
379	10026																																								
380	10027																																								
381	10028																																								
382	10029																																								
383	10030																																								
384	10031																																								
385	10032																																								
386	10033																																								
387	10034																																								
388	10070																																								
389	10071																																								
586	10035																																								
587	10036																																								

Function description	
SUPERVISION → MESSAGE CATEGORY → 300 TO 899	
700	10050
701	10046
702	10047
703	10048
704	10049
705	10037
706	10051
707	10052
708	10053
709	10054
710	10055
800	10056
801	10057
802	10058
803	10059
804	10060
805	10061
806	10062
807	10063
808	10064
809	10065
810	10066
Data type:	Integer
Access:	read/ write

13.7.4 Group "MESSAGE HISTORY"

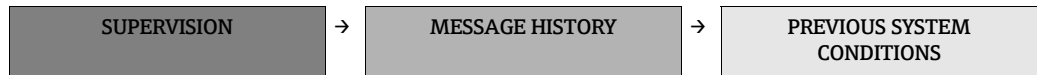

Function description SUPERVISION → MESSAGE HISTORY → PREVIOUS SYSTEM CONDITIONS	
PREVIOUS SYSTEM CONDITIONS Modbus register: Fault/notice message: 1 6842 2 6843 3 6844 4 6845 5 6846 6 6847 7 6848 8 6849 9 6850 10 6851 11 6852 12 6853 13 6854 14 6855 15 6856 16 6857 Data type: Integer Access: Read	Displays the last 16 messages to occur. Note! For more information, refer to the keyword "System or process error messages."

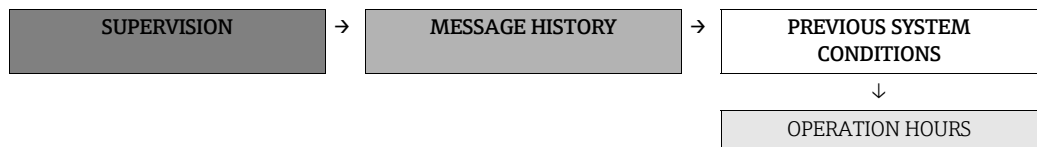

Function description SUPERVISION → MESSAGE HISTORY → OPERATION HOURS	
SYSTEM CONDITION OPERATING HOURS Modbus register: 1 8901 2 8903 3 8905 4 8907 5 8909 6 8911 7 8913 8 8915 9 8917 10 8919 11 8921 12 8923 13 8925 14 8927 15 8929 16 8931 Data type: Float Access: Read	This displays the status of the operating hours counter at which a message has occurred. Display: <ul style="list-style-type: none"> ▪ Status of operating hours < 10 hours → display format = 0:00:00 (hr:min:sec) ▪ Status of operating hours 10 to 10,000 hours → display format = 0000:00 (hr:min) ▪ Status of operating hours > 10,000 hours → display format = 000000 (hr)

Index

A

Ambient temperature range	49
Applicator (Auslege-Software)	36
Approval by (the Standards Authorities)	33
Approval for custody transfer	33
Approvals	8
Auto-scan buffer	25

B

Block	
BASIC FUNCTION	78
MEASURED VARIABLE	58
OUTPUTS	65
SECURITY	58
SUPERVISION	93
TOTALIZER	62
Broadcast message	19
Byte transmission sequence	23

C

Cable entries	48
Degree of protection	15
Technical data	48
Cable specifications	48
MODBUS RS485	12
CE mark (Declaration of Conformity)	8
Certificates	8
Cleaning	
External cleaning	35
Commissioning	
Zero point adjustment	31
Configuring the device address	29
Configuring the MODBUS device address	29
Connection	
See Electrical connection	
Custody transfer measurement	33
Approval for custody transfer	33

D

Data types	23
Declaration of Conformity (CE mark)	8
Degree of protection	15, 49
Design / dimensions	50
Designated use	4
Device designation	6
Device Functions	53
Diagnosis using LED	39
Disabling custody transfer mode	34
Display of function matrix	54
Disposal	45
Documentation	52

E

Electrical connection	
Degree of protection	15
Post-connection check	16
Electrical connections	48

Electromagnetic compatibility (EMC)	49
Error messages (MODBUS)	24
European Pressure Equipment Directive	51
Ex approval	51
External cleaning	35

F

Failsafe mode of the outputs	43
FieldCare	30
Flow rate	49
Frequency output	46-47
Function	
2ND CHANNEL	65
300 to 899	98
ACTUAL STATUS (status output)	77
ACTUAL SYSTEM CONDITION	93
ALARM DELAY	96
ASSIGN (frequency output)	71
ASSIGN (pulse output)	74
ASSIGN (totalizers 1 to 3)	62
ASSIGN LOW FLOW-CUTOFF	86
ASSIGN STATUS (status output)	77
BAUDRATE	78
BYTEORDER FLOAT	79
BYTEORDER INTEGER	79
BYTEORDER STRING	79
DELAY TELE.REPLY	78
DENSITY	58
DENSITY COEF. CO	92
DENSITY COEFFICIENT C1	92
DENSITY COEFFICIENT C2	92
DENSITY COEFFICIENT C3	92
DENSITY COEFFICIENT C4	92
DENSITY COEFFICIENT C5	92
END VALUE FREQUENCY	71
EPD RESPONSETIME	88
EPD VALUE LOW	88
FAIL.SENSITIVITY (frequency output)	72
FAIL.SENSITIVITY (pulse output)	75
FAILSAFE MODE (frequency output)	72
FAILSAFE MODE (MODBUS RS485)	80
FAILSAFE MODE (pulse output)	75
FAILSAFE MODE (Totalizer 1...3)	63
FAILURE SENSITIVITY (MODBUS RS485)	79
FAILURE SENSITIVITY (Totalizer 1...3)	63
FIELD BUS ADDRESS	78
FIXED DENSITY	89
FLOW DAMPING	90
INSTLATION DIRECTION SENSOR	90
K-FACTOR	91
LOWER LIMIT DENSITY	94
LOWER LIMIT MASSFLOW	94
LOWER LIMIT TEMPERATURE	94
LOWER LIMIT VOLUMEFLOW	94
M. FACTOR DENSITY	90
M. FACTOR MASSFLOW	90

M. FACTOR TEMPERATURE.....	91
M. FACTOR VOLUMEFLOW.....	90
M. OFFSET DENS.....	91
M. OFFSET MASSFLOW.....	90
M. OFFSET TEMPERATURE.....	91
M. OFFSET VOLUME FLOW.....	90
MASS FLOW.....	58
MEASURING MODE (frequency output).....	72
MEASURING MODE (pulse output).....	75
MEASURING MODE (totalizers 1 to 3).....	63
NOMINAL DIAMETER.....	91
ON-VALUE LOW FLOW-CUTOFF.....	86
OPERATION HOURS.....	93
OPERATION MODE.....	65
OUTPUT SIGNAL (frequency output).....	73
OUTPUT SIGNAL (pulse output).....	76
OVERFLOW (totalizers 1 to 3).....	64
PARITY.....	78
PERMANENT STORAGE.....	96
PRESS.SHOCK SUPP.....	87
PRESSURE.....	89
PRESSURE MODE.....	89
PREVIOUS SYSTEM CONDITIONS 1...16.....	100
PROGRAM CODE CRC.....	93
PROGRESS.....	88, 93
PULSE VALUE.....	74
PULSE WIDTH.....	74
RESET TOTALIZER (Totalizers 1 to 3).....	63
SCAN LIST REGISTER 1 TO 16.....	80
SECURITY.....	58
SENSOR TYPE.....	97
SERIAL NUMBER.....	97
SIMULATION MEASURAND.....	95
SOFTWARE-REVISION AMPLIFIER.....	97
SOFTWARE-REVISION DAT.....	97
SUM (totalizers 1 to 3).....	64
SYS.CON.OPHOUR 1...16.....	100
SYSTEM RESET.....	93
TAG NAME.....	79
TEMPERATURE.....	58
TRANSMISS. MODE.....	78
UNIT DENSITY.....	61
UNIT MASS.....	59
UNIT MASS (totalizers 1 to 3).....	62
UNIT MASS FLOW.....	59
UNIT PRESSURE.....	61
UNIT TEMPERATURE.....	61
UNIT VOLUME.....	60
UNIT VOLUME (totalizers 1 to 3).....	62
UNIT VOLUME FLOW.....	60
UPP. LIMIT DENS.....	94
UPPER LIMIT MASSFLOW.....	94
UPPER LIMIT TEMPERATURE.....	94
UPPER LIMIT VOLUMEFLOW.....	94
VALUE f HIGH.....	71
VALUE SIMULATION MEASURAND.....	95
VOLUME CALCULATION.....	89
VOLUME FLOW.....	58
ZERO POINT ADJUSTMENT.....	88
ZEROPOINT.....	88
ZEROPOINT (sensor data).....	91
Function code.....	21
Function matrix.....	54
FXA193.....	36
G	
Galvanic isolation.....	47
Grounding.....	13
Group	
MEASURING VALUES.....	58
MESSAGE CATEGORY.....	98
MESSAGE HISTORY.....	100
MODBUS RS485.....	78
PROCESS PARAMETER.....	86
PULSE/FREQUENCY OUTPUTS (1 to 2).....	65
SECURITY.....	58
SENSOR DATA.....	91
SYSTEM.....	93
SYSTEM PARAMETER.....	90
SYSTEM UNITS.....	59
TOTALIZER (1 to 3).....	62
VERSION-INFO.....	97
I	
Incoming acceptance.....	9
Influence of medium pressure.....	48
Influence of medium temperature.....	48
Inlet and outlet runs.....	49
Installation conditions	
Dimensions.....	10
Vibrations.....	10
Installation instructions.....	49
Installation, commissioning and operation.....	4
Installing the meter electronics.....	44
L	
Life Cycle Management.....	36
Limiting medium pressure range.....	49
Load.....	47
M	
Maintenance.....	35
Master/slave communication.....	19
Material.....	50
Maximum measured error.....	48
Measured variables.....	46
Measuring principle.....	46
Measuring range.....	46
Measuring system.....	6, 46
Medium temperature range.....	49
Messages (Fieldtool).....	40
Meter electronics (installation).....	44
MODBUS RS485	
Address model.....	22
Auto-scan buffer.....	25
Byte transmission sequence.....	23
Cable specification.....	12
Data types.....	23
Error messages.....	24

Function code	21	Spare parts	42
Master/slave devices	18	Standards, guidelines	51
Max. writes	21	Storage	9
Register address	22	Storage temperature	49
Response times	22	Suitability for custody transfer measurement	33
System architecture	18	Supply voltage	47
Technical data	47	Switching on the measuring device	31
Technology	18	System pressure	49
Telegram	20		
N		T	
Nameplate		Temperature ranges	
Connections	8	Storage temperature	49
Nameplate data		Transmitter	
Transmitter	6-7	Electrical connection	14
O		Transporting the sensor	9
Operable flow range	46	Troubleshooting	38
Operating conditions	49	Troubleshooting and remedy	38
Operation		Turning the transmitter housing	11
FieldCare	30		
Operational safety	4	V	
Order code		Vibration resistance	49
Transmitter	6-7	Vibrations	10, 49
Output signal	46-47		
P		W	
Performance characteristics		W@M	36
Influence of medium pressure	48	Weight	50
Influence of medium temperature	48	Wiring	12
Maximum measured error	48	See Electrical connection	
Repeatability	48	Writes (max.)	21
Polling	19		
Post-installation check (checklist)	11	Z	
Potential equalization	48	Zero point adjustment	31
Power consumption	47		
Power supply failure	48		
Pressure loss	49		
Pressure measuring device approval	51		
Process connections	50		
Process error (without message)	42		
Pulse output			
See Frequency output			
R			
Register address	22		
Registered trademarks	8		
Repeatability	48		
Repeatability (performance characteristics)	48		
Repeated calibration due to legal metrology controls ..	33		
S			
Safety conventions	5		
Safety instructions	4		
S-DAT (HistoROM)	32		
Serial number	6-7		
Setting up custody transfer mode	34		
Shielding	13		
Shock resistance	49		
Signal on alarm	47		

www.addresses.endress.com
