

Model 8533/8534

DUSTTRAK™ DRX Aerosol Monitor

Operation and Service Manual

P/N 6001898, Revision F
January 2011



TTT Environmental
Instruments and Supplies

*The preferred source for instrument
Rentals, Sales, Service and Supplies!*

4201 B Street
Anchorage, AK 99503
(907) 770-9041

www.tttenviro.com

25420 74th Avenue S.
Kent, VA 98032
(253) 373-9041

info@tttenviro.com



TRUST. SCIENCE. INNOVATION.

Copyright ©

TSI Incorporated / 2008–2011 / All rights reserved.

Address

TSI Incorporated / 500 Cardigan Road / Shoreview, MN 55126 / USA

Fax No.

(651) 490-3824

Limitation of Warranty and Liability (effective July 2000)

Seller warrants the goods sold hereunder, under normal use and service as described in the operator's manual, shall be free from defects in workmanship and material for twenty-four (24) months, or the length of time specified in the operator's manual, from the date of shipment to the customer. This warranty period is inclusive of any statutory warranty. This limited warranty is subject to the following exclusions:

- a. Hot-wire or hot-film sensors used with research anemometers, and certain other components when indicated in specifications, are warranted for 90 days from the date of shipment.
- b. Parts repaired or replaced as a result of repair services are warranted to be free from defects in workmanship and material, under normal use, for 90 days from the date of shipment.
- c. Seller does not provide any warranty on finished goods manufactured by others or on any fuses, batteries or other consumable materials. Only the original manufacturer's warranty applies.
- d. Unless specifically authorized in a separate writing by Seller, Seller makes no warranty with respect to, and shall have no liability in connection with, goods which are incorporated into other products or equipment, or which are modified by any person other than Seller.

The foregoing is IN LIEU OF all other warranties and is subject to the LIMITATIONS stated herein. **NO OTHER EXPRESS OR IMPLIED WARRANTY OF FITNESS FOR PARTICULAR PURPOSE OR MERCHANTABILITY IS MADE.**

TO THE EXTENT PERMITTED BY LAW, THE EXCLUSIVE REMEDY OF THE USER OR BUYER, AND THE LIMIT OF SELLER'S LIABILITY FOR ANY AND ALL LOSSES, INJURIES, OR DAMAGES CONCERNING THE GOODS (INCLUDING CLAIMS BASED ON CONTRACT, NEGLIGENCE, TORT, STRICT LIABILITY OR OTHERWISE) SHALL BE THE RETURN OF GOODS TO SELLER AND THE REFUND OF THE PURCHASE PRICE, OR, AT THE OPTION OF SELLER, THE REPAIR OR REPLACEMENT OF THE GOODS. IN NO EVENT SHALL SELLER BE LIABLE FOR ANY SPECIAL, CONSEQUENTIAL OR INCIDENTAL DAMAGES. SELLER SHALL NOT BE RESPONSIBLE FOR INSTALLATION, DISMANTLING OR REINSTALLATION COSTS OR CHARGES. No Action, regardless of form, may be brought against Seller more than 12 months after a cause of action has accrued. The goods returned under warranty to Seller's factory shall be at Buyer's risk of loss, and will be returned, if at all, at Seller's risk of loss.

Buyer and all users are deemed to have accepted this LIMITATION OF WARRANTY AND LIABILITY, which contains the complete and exclusive limited warranty of Seller. This LIMITATION OF WARRANTY AND LIABILITY may not be amended, modified or its terms waived, except by writing signed by an Officer of Seller.

Service Policy

Knowing that inoperative or defective instruments are as detrimental to TSI as they are to our customers, our service policy is designed to give prompt attention to any problems. If any malfunction is discovered, please contact your nearest sales office or representative, or call TSI at (800) 874-2811 (USA) or (001 651) 490-2811 (International).

CONTENTS

SAFETY INFORMATION	III
Laser Safety	iii
Labels	iv
Description of Caution/Warning Symbols	iv
Caution	iv
Warning	iv
Caution and Warning Symbols	v
Reusing and Recycling	v
CHAPTER 1 UNPACKING AND PARTS IDENTIFICATION.....	1
Unpacking the DUSTTRAK™ DRX Aerosol Monitor	1
Parts Identification for the DUSTTRAK™ DRX Desktop Aerosol Monitor Model 8533.....	5
Parts Identification for the DUSTTRAK™ DRX Handheld Aerosol Monitor Model 8534.....	6
CHAPTER 2 SETTING UP	7
Supplying Power to the DUSTTRAK™ DRX Aerosol Monitor	7
Installing the Batteries in 8533 Desktop.....	7
Installing the Batteries in 8534 Handheld	7
Using the AC Adapter to Run Instrument.....	8
Battery Charging	8
Inlet Cap	8
Instrument Setup	9
Connecting to the Computer	9
Installing TRAKPRO™ Data Analysis Software	9
Connecting Analog/Alarm Output	10
Wiring the Analog Output.....	10
Wiring the Alarm	11
CHAPTER 3 OPERATION	13
Getting Started.....	13
Setup Menu	14
Zero Cal.....	15
Flow Cal	16
User Cal	17
Alarm	24
Analog	27
Settings	28
Run Mode.....	30
Survey Mode	31
Manual Mode.....	32
Log Mode (1–5).....	33

Taking Mass Concentration Measurements	34
Screen Regions	35
Stats	36
Graphing.....	38
Viewing Data.....	40
Title Bar.....	41
CHAPTER 4 MAINTENANCE	43
Maintenance Schedule	43
Zeroing Instrument.....	44
Cleaning the Inlet.....	45
Cleaning 2.5 µm Calibration Impactor	46
Replacing the Internal Filters	47
Storage Precautions	51
CHAPTER 5 TROUBLESHOOTING	53
APPENDIX A SPECIFICATIONS	57
APPENDIX B DRX ADVANCED CALIBRATION	59
Option 1: Serial Gravimetric Calibration	59
Step 1: PCF Calibration.....	59
Step 2: SCF Calibration.....	59
Option 2: Parallel Gravimetric Calibration.....	60
APPENDIX C ZERO MODULE.....	63
INDEX	65

These Application Notes can also be found under TSI's web site:

<http://www.tsi.com>

[*EXPMN-002 DustTrak DRX Theory of Operation.pdf*](#)

[*EXPMN-004 DRX-TEOM Comparison.pdf*](#)

[*EXPMN-005 DustTrak DRX Standard and Advance Calibration.pdf*](#)

Safety Information

IMPORTANT

There are no user serviceable parts inside the instrument. Refer all repair and maintenance to a qualified factory-authorized technician. All maintenance and repair information in this manual is included for use by a qualified factory-authorized technician.

Laser Safety

- The Model 8533/8534 DUSTTRAK™ DRX monitor is a Class I laser-based instrument
- During normal operation, you will *not* be exposed to laser radiation
- Precaution should be taken to avoid exposure to hazardous radiation in the form of intense, focused, visible light
- Exposure to this light may cause blindness

Take these precautions:

- **DO NOT** remove any parts from the DUSTTRAK™ DRX monitor unless you are specifically told to do so in this manual
- **DO NOT** remove the housing or covers. There are no serviceable components inside the housing



WARNING

The use of controls, adjustments, or procedures other than those specified in this manual may result in exposure to hazardous optical radiation.





WARNING

There are no user-serviceable parts inside this instrument. The instrument should only be opened by TSI or a TSI approved service technician.

When operated according to the manufacturer's instruction, this device is a Class I laser product as defined by U.S. Department of Health and Human Services standards under the Radiation Control for Health and Safety Act of 1968. A certification and identification label like the one shown below is affixed to each instrument.

Labels

Advisory labels and identification labels are attached to the instrument.

<p>1. Serial Number Label (bottom)</p>	
<p>2. Laser Radiation Label (internal)</p>	<p style="text-align: center;">DANGER! VISIBLE LASER RADIATION WHEN OPEN. AVOID DIRECT EXPOSURE TO BEAM WARNING: NO USER SERVICABLE PARTS INSIDE. REFER SERVICING TO QUALIFIED PERSONNEL</p>
<p>3. European symbol for non-disposable item. Item must be recycled.</p>	

Description of Caution/Warning Symbols

Appropriate caution/warning statements are used throughout the manual and on the instrument that require you to take cautionary measures when working with the instrument.

Caution



Caution
<p>Failure to follow the procedures prescribed in this manual might result in irreparable equipment damage. Important information about the operation and maintenance of this instrument is included in this manual.</p>



Warning



WARNING
<p>Warning means that unsafe use of the instrument could result in serious injury to you or cause damage to the instrument. Follow the procedures prescribed.</p>

Caution and Warning Symbols

The following symbols may accompany cautions and warnings to indicate the nature and consequences of hazards:

	Warns that the instrument contains a laser and that important information about its safe operation and maintenance is included in the manual.
	Warns that the instrument is susceptible to electro-static discharge (ESD) and ESD protection should be followed to avoid damage.
	Indicates the connector is connected to earth ground and cabinet ground.

Reusing and Recycling



As part of TSI Incorporated's effort to have a minimal negative impact on the communities in which its products are manufactured and used:

- ❑ Do **not** dispose of used batteries in the trash. Follow local environmental requirements for battery recycling.
- ❑ If instrument becomes obsolete, return to TSI for disassembly and recycling.

(page intentionally left blank)





Chapter 1





Unpacking and Parts Identification



Carefully unpack the Model 8533/34 DUSTTRAK™ DRX Aerosol Monitor from the shipping container. Use the tables and illustrations below to make certain that there are no missing components. Contact TSI immediately if anything is missing or damaged.

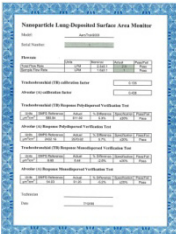

Unpacking the DUSTTRAK™ DRX Aerosol Monitor

Compare all the components you received with those listed in the table below. If any parts are missing, contact TSI.

Item	Qty	Part Number	Description
 <i>or</i> 	1	8533 8534	Desktop DRX Handheld DRX
	1	801670 801669	Desktop DRX Carrying Case Handheld DRX Carrying Case
	1	1090014	Data Analysis Software CD- ROM

Item	Qty	Part Number	Description
	1	800663	Zero Filter
 <p style="text-align: center;">or</p> 	1	801680 801681	6600 mAh Lithium Ion Rechargeable Battery (Desktop) Rechargeable lithium ion battery (Handheld)
	1	1303740	USB cable
	1	801652	Analog/alarm output cable (Desktop models only)
	1	6001898	Operation and Service Manual
	1	N/A	Calibration Certificate

Item	Qty	Part Number	Description
	1	801688	Conductive Tubing
	1	801668	Filter removal tool (Spanner Driver)
  	4 2 1	801673	Spare Internal Filter Elements Desktop Model Only 37-mm filter includes: Filter body top Filter body bottom Mesh Screen Comes with 37-mm cartridge opening tool.
	8	801666	Spare Internal Filters Handheld Model Only
	1	801671	Calibration Impactor Kit PM _{2.5} which includes: Impactor top Impactor bottom Impaction plate

Item	Qty	Part Number	Description
	1	801692 801694	Power Supply – Desktop Power Supply - Handheld
	2	N/A	Stylus When shipped, one stylus will be in the accessory bag, the second stylus is attached to instrument.
	1	3012094	Screwdriver, dual ended. (For Handheld Models only)
	1	801674	Impactor Oil
	2	801698	Inlet cap When shipped, one inlet will be in the accessory bag, the second inlet is attached to instrument.

Parts Identification for the DUSTTRAK™ DRX Desktop Aerosol Monitor Model 8533

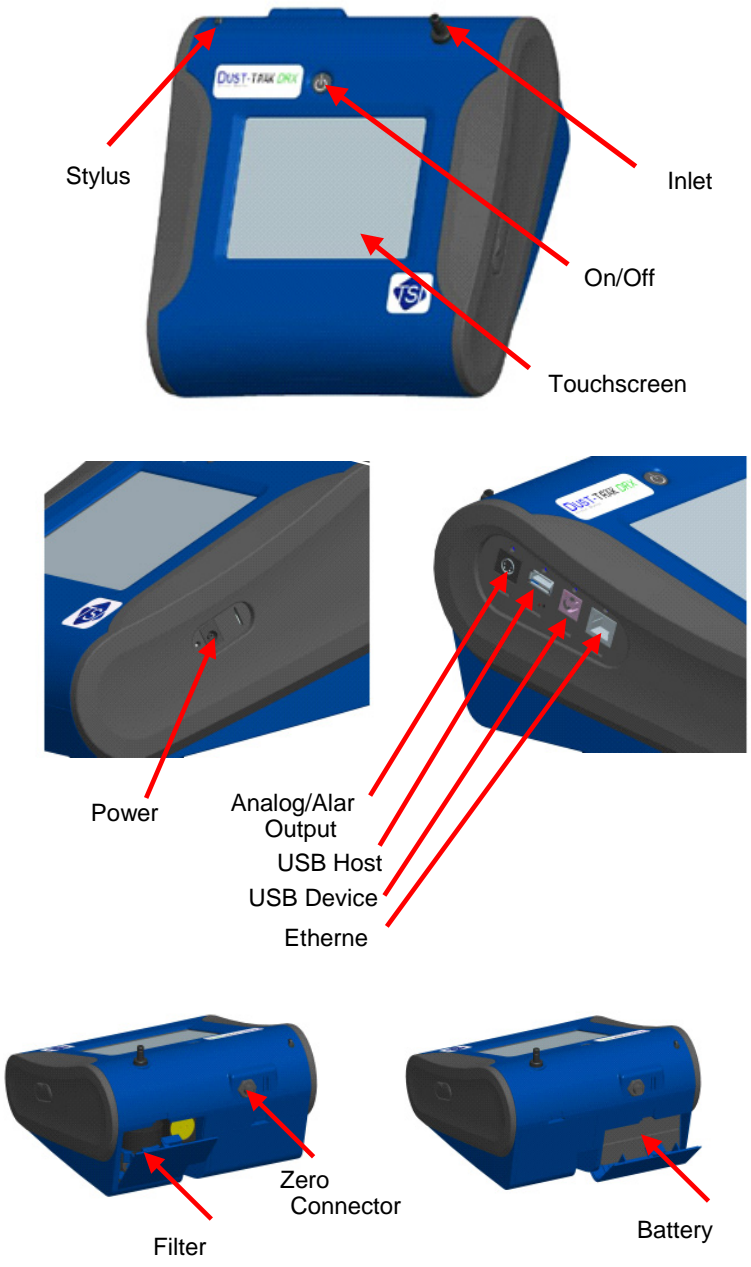

Figure 1-1: Features on Desktop Model

Parts Identification for the DUSTTRAK™ DRX Handheld Aerosol Monitor Model 8534

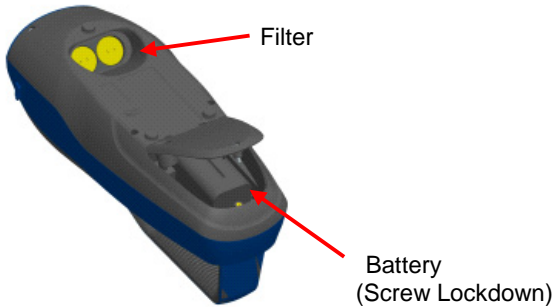
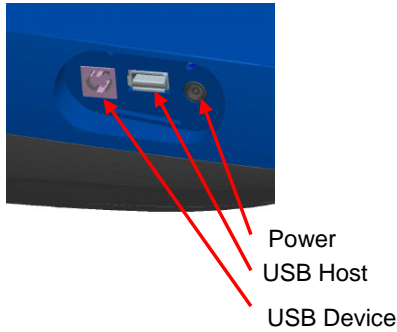
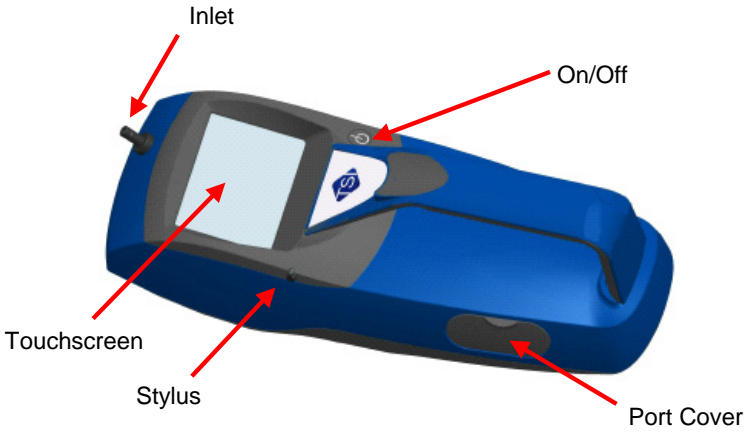

Figure 1-2: Features on Handheld Model

Chapter 2

Setting Up

Supplying Power to the DUSTTRAK™ DRX Aerosol Monitor

The Model 8533 and 8534 DUSTTRAK™ DRX Aerosol Monitor must be powered by either batteries or use of the external AC adapter.



WARNING

The instrument has been design to be used with batteries supplied by TSI. Do **not** use a substitute.



WARNING

Do **not** use non-rechargeable batteries in this instrument. Fire, explosions, or other hazards may result.

Installing the Batteries in 8533 Desktop

Remove the battery cover and slide one or two batteries into the battery slots. A single battery can be put into either slot. Orient the batteries with the label side facing up (see figure 2-1).

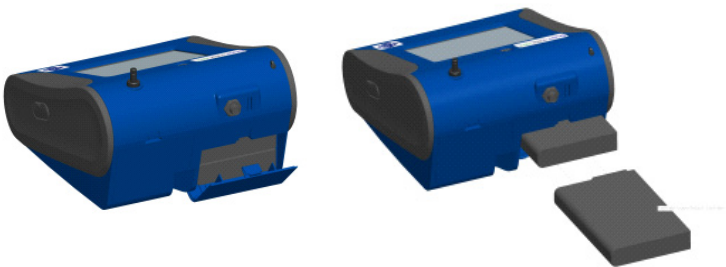

Figure 2-1: Batteries into Desktop Unit

Installing the Batteries in 8534 Handheld

Remove the battery cover by loosening captured screw on the bottom of the unit. Orient battery with brass connectors facing forward. Insert battery into cavity and slide forward to engage into pins. Replace the battery cover and secure by tightening screw (see figure 2-2).

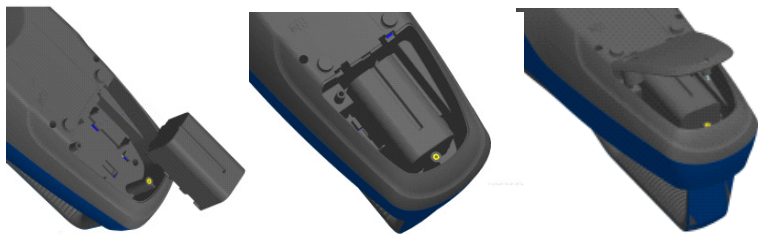

Figure 2-2: Batteries into Handheld Unit

Using the AC Adapter to Run Instrument

The AC adapter allows you to power the DUSTTRAK™ monitor from an AC wall outlet. When using the AC adapter, the batteries (if installed) will be bypassed.

Battery Charging

This instrument will charge the Lithium Ion battery packs. Insert the batteries into the battery compartment, plug the instrument into AC power, and turn the instrument on. Batteries will charge only when the instrument is on and in stand-by mode. Batteries will not be charged if the instrument is turned off or is actively taken measurements. Charging will stop when the batteries have been fully charged.

Inlet Cap

When using the DUSTTRAK™ monitor to sample environmental air, the inlet cap should be put over the instrument. This cap will keep large objects from dropping into and plugging the inlet. The cap will also keep direct light from shining into the chamber and skewing the results.

The inlet cap can simply be pressed onto the instruments inlet.



Figure 2-3: Putting on Inlet Cap

Instrument Setup

The DUSTTRAK™ DRX monitor can be connected to a computer to download data and upload sampling programs.

Connecting to the Computer

Connect the USB host port of a Microsoft Windows®-based computer to the USB device port on the side of the DUSTTRAK™ monitor.

Installing TRAKPRO™ Data Analysis Software

TRAKPRO™ software can preprogram the DUSTTRAK™ monitor, download data, view and create raw data and statistical reports, create graphs, and combine graphs with data from other TSI instruments that use TRAKPRO™ software. The following sections describe how to install the software and set up the computer.

Note
To use TRAKPRO™ software with the DUSTTRAK™ Aerosol Monitor, the PC must be running Microsoft Windows® and the computer must have an available Universal Serial Bus (USB) port.

1. Insert the TRAKPRO™ Data Analysis Software CD into the CD-ROM drive. The install screen starts automatically.

Note
If the software does not start automatically after a few minutes, manually run the program listed on the label of the CD using the Run command on the Windows Start Menu.

2. Follow the directions to install TRAKPRO™ software.

TRAKPRO™ software contains a comprehensive installation guide. It is recommended you print out this prior to starting the TRAKPRO™ software installation on your computer, so it may be consulted during the installation. The TRAKPRO™ Software manual is located in the “Help” file in TRAKPRO™ software. There is no separately printed TRAKPRO™ Data Analysis software manual.

®Microsoft and Windows are registered trademarks of Microsoft Corporation.

Connecting Analog/Alarm Output

The Analog/Alarm Output Cable plugs into the alarm connection on the side of the instrument. This feature is on the desktop models (II, II HC and 8533) only.

The cable contains a 4-pin, mini-DIN connector. The pin-outs for the connector and the wiring for the cable are shown below.

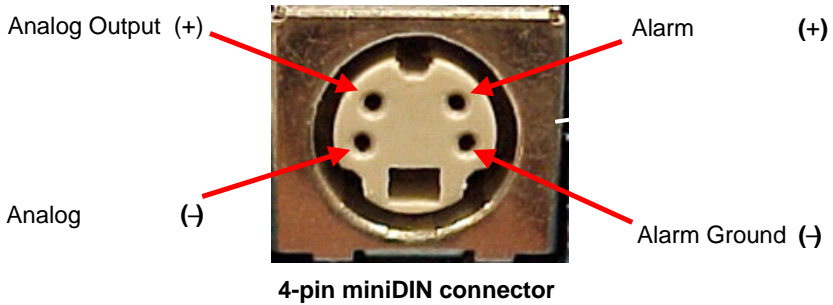

Cable Wiring Diagram	
Brown Wire	Analog Ground
Orange Wire	Analog Out
Red Wire	Alarm (+)
White Wire	Alarm (-)
Black Wire	Shield

Figure 2-4: Cable Wiring Diagram

Wiring the Analog Output

- Output voltage: 0 to 5 VDC.
- Output impedance: 0.01 ohm.
- Maximum output current: 15 mA.
- Correct polarity must be observed (see pin-outs above).

The output cable supplied by TSI (part no. 801652) is labeled with the pin-out wiring diagram. Additional equipment may be needed for making connections to the system that TSI does not supply. It is the user's responsibility to specify and supply all additional equipment.

Wiring the Alarm

System specifications:

- Maximum voltage: 15 VDC (**DO NOT USE AC POWER**)
- Maximum current: 1 Amp
- Correct polarity must be observed (see pin-outs above)
- The alarm switch, located inside the DUSTTRAK™ monitor must be located on the ground side of the alarm system.



WARNING

The DUSTTRAK™ monitor Alarm Output function should **not** be used to detect hazardous conditions or to provide an alarm for protecting human life, health or safety.



Caution

The alarm switch must **not** be wired to AC power! Failure to properly install the user alarm could damage the DUSTTRAK™ instrument and/or void the instrument warranty! Please read and follow all instructions before wiring or operating the user alarm.

(page intentionally left blank)

Chapter 3

Operation

Getting Started

The **START UP** screen is displayed initially when the instrument is turned on, following the initial TSI logo splash screen.

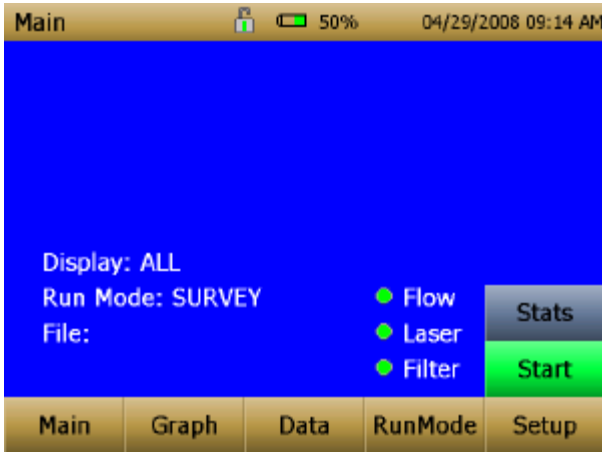

Using a stylus or finger tip, touch the “buttons” on the screen to activate different menus.

Setup Menu

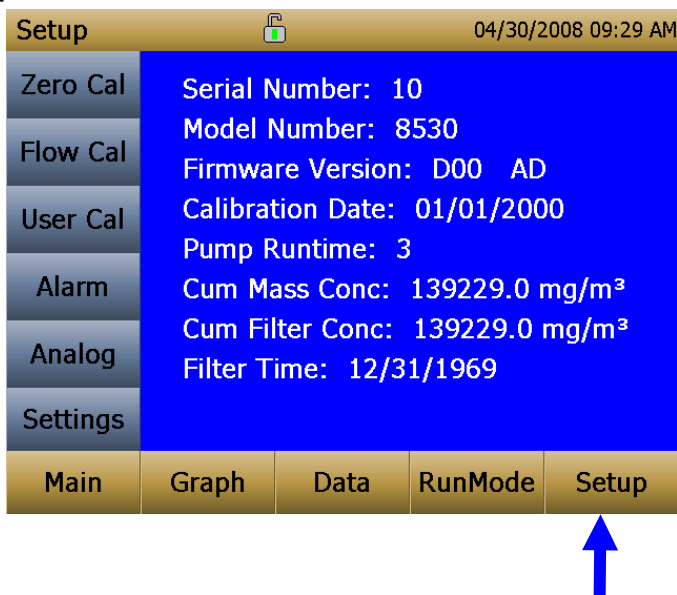

Pressing **Setup** activates the Setup Menu touchscreen buttons along the left edge of the screen. Setup cannot be accessed when the instrument is sampling.

The main screen of the **Setup** screen displays the following information:

Serial Number	The instruments serial number.
Model Number	The instruments model number.
Firmware Version	Instruments current version of firmware.
Calibration Date	Date of the last factory calibration.
Pump Run Time	Pump running time in hours.
Cum Mass Conc	Amount of mass run through instrument over life.
Cum Filter Conc	Amount of mass run through instrument since last filter change.
Filter Time	Date of last filter change.

Zero Cal

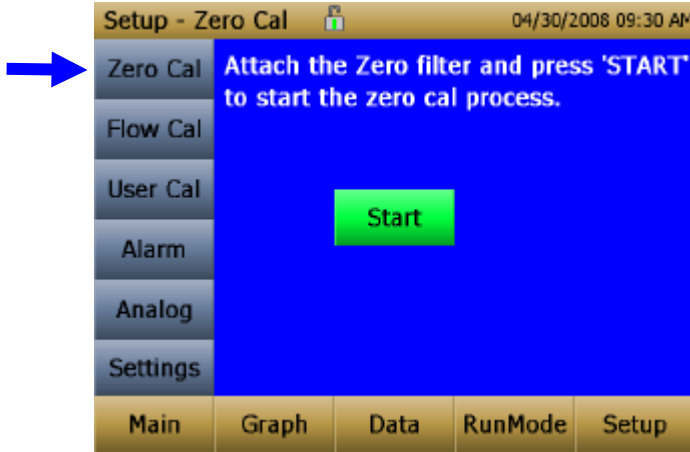

Zero Cal should be run the first time the instrument is used and should be repeated prior to every use. Zero Cal requires that the zero filter be attached prior to running.

Never perform a zero cal without attaching a zero filter.

1. Press Zero Cal Button
2. Attach Zero Filter
3. Press the **Start** button to start Zeroing process.
4. A count-down clock will appear indicating the time remaining. The screen will indicate “Zero Cal Complete” when done.

Remove filter after zeroing has been completed. The instrument is now zero calibrated and ready for use.

Flow Cal

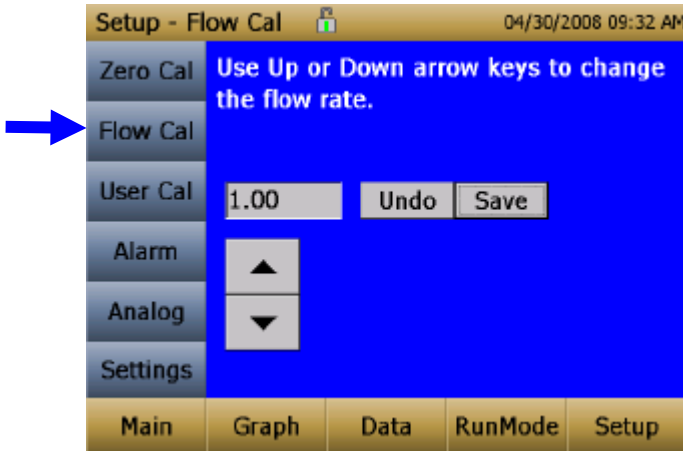

Flow Cal is run if the user wants to change the flow set point. The flow set point is factory set to 3 L/min total flow. 2 L/min of the total flow is measured aerosol flow. 1 L/min of total flow is split off, filtered and used for sheath flow. There is an internal ΔP flowmeter in the DUSTTRAK™ DRX instrument that controls flow rate to $\pm 5\%$ if factory setpoint. It is recommended to check the flows with an external flow reference meter, especially when collecting data. The pump will automatically start when entering the Flow Cal screen.

1. Attach a flow calibrator (reference flow meter) to inlet port. You may use a bubble buret, mass flow meter, dry piston or rotameter as flow measurement devices.
2. Move the arrows up or down to achieve desired flow on the reference flowmeter. Each up or down arrow will change the flow about 1%. Allow time between button presses to let pump change to the new flow rate.
3. Select save once the desired flow rate is achieved. Select **Undo** to return to the factory set point.

User Cal

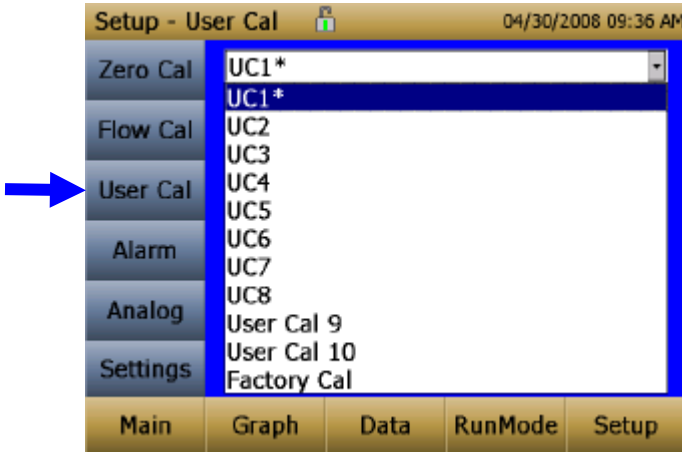

User Cal allows the user to store and use 10 different calibration factors. The currently active user calibration is highlighted with an asterisk “*”.

Four variables can be set for each user calibration.

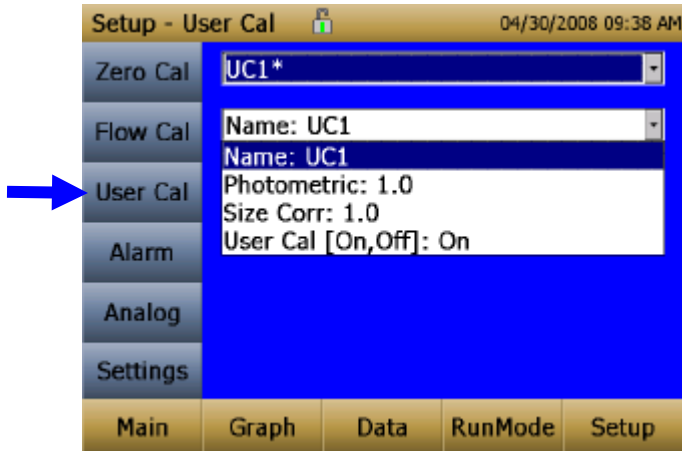

Name	User can rename calibration to a description name.
Photometric	Changes the factory calibration of particle signal, based on Arizona Road Dust, to actual aerosol being measured. See below for sets to set this calibration.

Size Corr	Changes the factory calibration of the particle distribution, based on Arizona Road Dust, to actual aerosol being measured. See below for sets to set this calibration.
User Cal [on,off]	Selecting On will activate current user calibration and deactivate the previously selected user calibration.

The Size and Photometric Calibration factors can be determine using a standard or advanced calibration method. The standard method is quick and easy to perform and works well in most situations. That method is shown below. The advanced method will give the tightest accuracy and is described in [Appendix B](#).

Standard Calibration Method—Size Correction Factor

The size correction factor is used to improve the relative accuracy between the 5 mass channels (PM₁, PM_{2.5}, Resp, PM₁₀, and Total). The instrument has been optimized in the factory calibration to standard ISO 12103-1, A1 test dust (formerly Arizona Test Dust).

Following the steps below, a size correction factor can be determined for the aerosol of interest to better optimize the 5 mass channels relative accuracy.

Note: The 2.5 μm inlet impactor should be clean before performing the shape calibration. The cleaning procedure is details in the [Maintenance](#) section of this manual.

1. Select **Size Corr** from the drop down list.

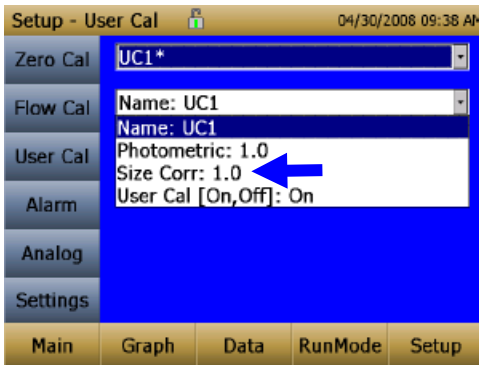

2. Press the **Custom Cal** button.

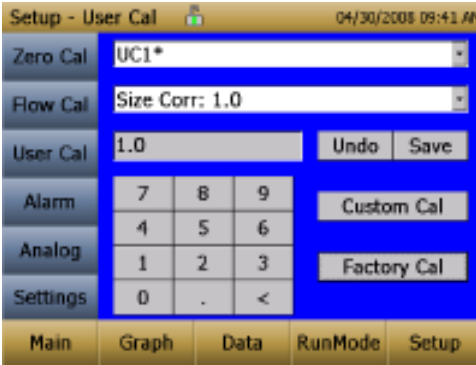

3. Follow the on screen steps to determine the size Corr. The PM_{2.5} impactor is required for this step.

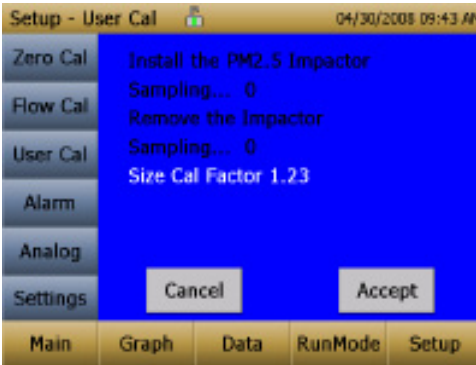

4. Save the calculated value.

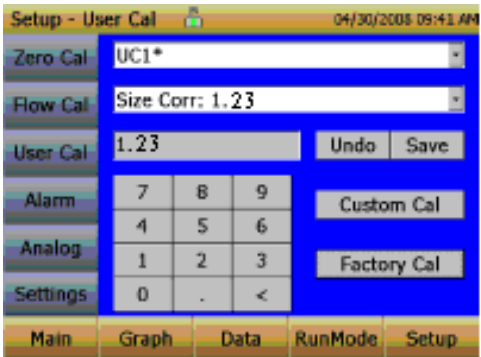

Taking a Gravimetric Sample Using the DUSTTRAK™ Monitor

When sampling with the DUSTTRAK™ monitor, you can simultaneously take a gravimetric sample either for custom calibration of the DUSTTRAK™ monitor or for collecting the sample on to the gravimetric filter downstream of the DUSTTRAK™ monitor without a need for additional gravimetric sampling pump and filter assembly. To accomplish this, follow the instructions given below:

1. Setup the DUSTTRAK™ monitor to sample how long you want the sample run time to be. The following example shows a sample for 8 hours.
2. Under RunMode menu, put the instrument in Manual Log (Manual Logging is reviewed later in this section), which will enable you to start and stop the pump at any time you choose.
3. Set the logging interval. One minute (i.e., “01:00”) is a good choice.
4. Make sure you have a preweighed 37-mm gravimetric filter cassette loaded into the DUSTTRAK™ monitor. See Chapter 4, “[Replacing the Internal Filters](#)” on how to access the filter (see [figure 4-8](#)) and replace it.

Note

Use only the conductive plastic filter cassette holder (SKC Part# 225-308).

5. Under the Setup Menu, make sure the DUSTTRAK™ monitor is set to the desired flow rate. For DUSTTRAK™ II Model 8530, the flows can be varied from 1.7 to 4 L/min for use with various inlet conditioners. For DUSTTRAK™ DRX Model 8533, **the flow cannot be changed**. The flows for DUSTTRAK™ II monitor can be changed by changing the default flow calibration setpoint from 1.0 to any value between 0.5 to 1.5 in the span adjustment. An external flowmeter is needed to measure the total flow. Flow can be changed by clicking on the UP or DOWN arrow keys shown below:

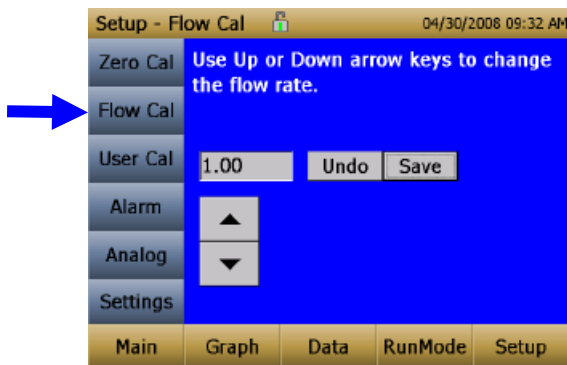

6. Conduct a preflow calibration on the DUSTTRAK™ monitor using the same kind of sample media you will sample with. Now, attach the sample media you intend to sample with and start sampling aerosol for the desired time. After the desired run time, stop the sampling. Remove the filter from the DUSTTRAK™ monitor and follow your laboratory's criteria for filter post weight. Conduct a post-flow calibration with the same sample media done with the pre-flow calibration and determine if these flow calibrations are within ±5% of each other. If they are, use the following to calculate the actual flow rate for the DUSTTRAK™ monitor. The laboratory will need the following information to calculate mass concentration in mg/m³:
 - Total sample time in minutes.
 - Flow rate—The flow rate of the DUSTTRAK™ monitor used for gravimetric analysis is only ²/₃ the total flow since ¹/₃ of the flow is used as sheath flow.
 - Total liters of air sampled = total sample time x flow rate.
7. Using this information the laboratory can determine the concentration using the following formula:

$$\text{Concentration, } \frac{\text{mg}}{\text{m}^3} = \frac{\left\{ \frac{\text{Filter Post Weight (mg)} - \text{Filter Pre Weight (mg)}}{\text{DustTrak™ Monitor}} \right\} \times \text{Total Sample Time (min)}}{\frac{2}{3} \times \frac{\text{Flow Rate (L/min)}}{1000}}$$

Note
The flow rate used for gravimetric analysis is only ² / ₃ the total flow since ¹ / ₃ of the flow is used as sheath flow.

8. For instructions on how to calibrate the DUSTTRAK™ monitor using this data, see section below on [“Determining the Calibration Factor for a Specific Aerosol”](#).

Standard Calibration Method—Photometric Calibration Factor

In most situations, the DUSTTRAK™ monitor with its built-in data logging capability can provide very good information on how the concentration of an aerosol changes for different processes over time. Factory calibration to the respirable fraction of standard ISO 12103-1, A1 test dust is fairly representative of a wide variety of ambient aerosols. Because optical mass measurements are dependent upon particle size and material properties, there may be times in which a custom calibration would improve your accuracy for a specific aerosol.

Determining a aerosol specific photometric calibration requires that you determine a true mass concentration (e.g., gravimetric analysis) for the

aerosol you want to measure. The true mass concentration is used to calculate the custom calibration factor for that aerosol. Once you have a custom calibration factor, you can reuse it each time you make measurements in the same aerosol environment.

Determining the Calibration Factor for a Specific Aerosol

The DUSTTRAK™ DRX monitor is factory calibrated to the respirable fraction of standard ISO 12103-1, A1 test dust. The DUSTTRAK™ monitor can be easily calibrated to any arbitrary aerosol by adjusting the custom calibration factor. The DUSTTRAK™ monitor's custom calibration factor is assigned the value of 1.00 for the factory calibration to standard ISO test dust. This procedure describes how to determine the calibration factor for a specific aerosol. Using the value of 1.00 will always revert back to the factory calibration.

To determine a new calibration factor you need some way of accurately measuring the concentration of aerosol, hereafter referred to as the reference instrument. A gravimetric analysis is often the best choice, though it is limited to nonvolatile aerosols.

To make an accurate calibration you must simultaneously measure the aerosol concentration with the DUSTTRAK™ monitor and your reference instrument.

1. Zero the DUSTTRAK™ DRX monitor.
2. Put the instrument in Manual Log (Manual Logging is reviewed later in this section).
3. Set the logging interval. One minute (i.e., "01:00") is often a good choice.
4. Co-locate the DUSTTRAK™ DRX monitor and the reference sampler together so that they are measuring from the same area.
5. Start sampling aerosol with both instruments at the same time.

Note
Greater accuracy will be obtained with longer samples. The time you permit for sampling often depends on the reference instrument and characteristics of the measured aerosol. It may take some time to collect sufficient aerosol onto a filter cassette for accurate gravimetric analysis. Refer to instructions of your reference instrument for sampling times.

6. Stop sampling with both instruments at the same time.

7. Record the DUSTTRAK™ monitor average concentration. This can be done by viewing the sample average in the Data screen. (Data Screen is reviewed later in this chapter)
8. Determine the mass concentration in mg/m³ from your reference instrument. For gravimetric sampling this means having the gravimetric sample weighed.

Note

If you used the internal gravimetric filter in the DUSTTRAK™ Model 8530, the flow rate used to compute the concentration should be 2 L/min, not 3 L/min since only 2 L/min of aerosol flow reaches the filter.

9. Compute the new calibration constant, NewCal, using the following formula:

$$\text{NewCal} = \left(\frac{\text{Reference Concentration}}{\text{DustTrak Concentration}} \right) \cdot \text{CurrentCal}$$

10. Select **Photometric** from the User Cal drop down selection and enter the NewCal factor using the onscreen controls.

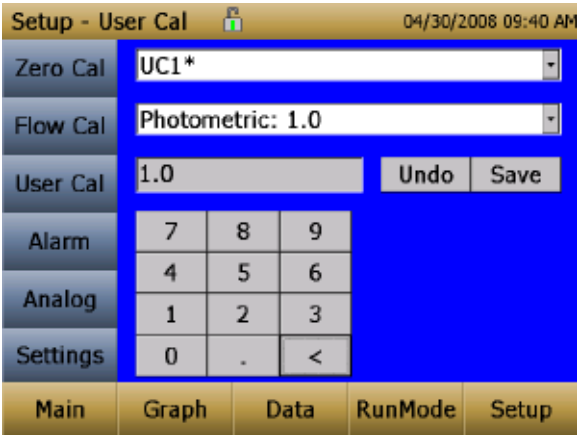

Alarm



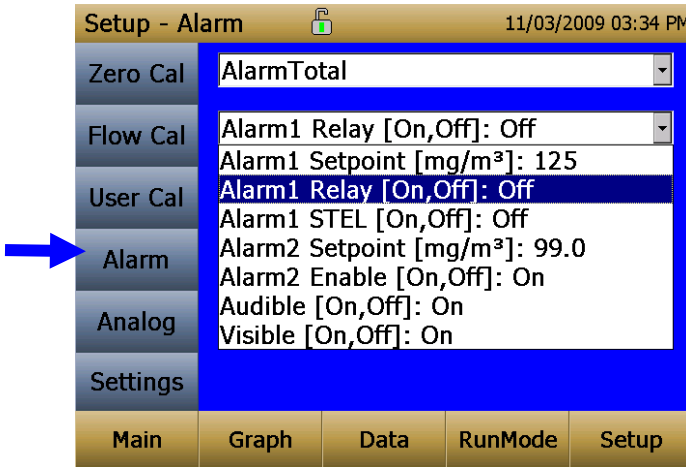

Alarm allows the user to set alarm levels on any of the 5 mass channels PM₁, PM_{2.5}, RESP, PM₁₀ and Total.

For each mass channel, an alarm set point level and alarm type can be set.



Alarm1 Setpoint [mg/m³]	<p>The alarm1 setpoint is the mass concentration level upon which the alarm1 is triggered.</p> <p>Alarm will be triggered if the mass concentration, taken at the logging interval, rises above the setpoint.</p> <p><i>Note: Alarm 2 must be lower than Alarm 1 when both alarms are enabled.</i></p>
Relay1 [On, Off]	<p>When the relay alarm is turned on, unit will close relay switch when Alarm1 level is surpassed.</p> <p>Relay alarm can only be linked to one mass channel at a time.</p> <p>Relay selection is available on the 8533 desktop model only.</p>
STEL 1 [On, Off]	<p>When the STEL alarm is turned on, STEL data will be collected when Alarm1 level is surpassed.</p> <p>STEL alarm can only be linked to one mass channel at a time.</p> <p>STEL selection is available on the 8533 desktop model only.</p> <p>See following STEL Note.</p>
Alarm2 Setpoint [mg/m³]	<p>The alarm2 setpoint is the mass concentration level upon which the alarm2 is triggered.</p> <p>Alarm will be triggered if the mass concentration, taken at the logging interval, rises above the setpoint.</p> <p><i>Note: Alarm 2 must be lower than Alarm 1 when both alarms are enabled.</i></p>
Alarm2 Enable [On, Off]	<p>Enables Alarm2 to be logged and will activate the Audible or Visible alarms if they are enabled.</p>

Audible [On, Off]	When the audible alarm is turned on, the instrument will activate internal beeper when Alarm1 or Alarm2 level is surpassed. Audible alarm can only be linked to one mass channel at a time.
Visible [On, Off]	When the visible alarm is turned on, unit will show the alarm icon (Alarm1  , Alarm 2 ) in title bar when Alarm1 or Alarm2 level is surpassed.

STEL Alarm

STEL stands for **Short Term Exposure Limit**. When a STEL alarm is selected, the instrument will inspect the data on a second by second basis, independent from the selected logging interval. If the mass exceeds the STEL limit, a STEL even will be triggered and the following actions will be taken.

STEL indicator	The STEL indicator  will show Red on the main screen.
Data	Data will be taken of the STEL alarm channel at a 1 minute logging interval for 15 minutes . This data will be stored in a separate file named STEL_XXX, where XXX will be matched to the logged data file. The instrument will also continue to log the mass concentration data at the logging interval selected.
STEL Alarm repeat	If the instrument remains over the STEL limit after the 15 minute interval, or if the instrument exceeds the STEL limit later during the sample period, additional STEL files will be generated.

Analog

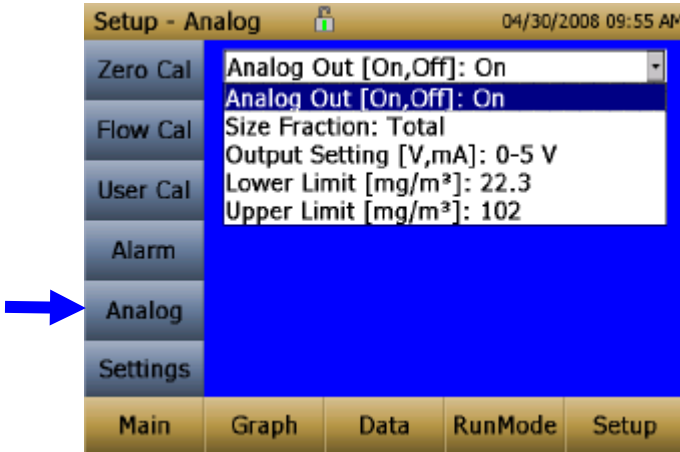

Analog setup screen sets the parameters that will drive the analog out port. Applies to the 8533 Desktop model only.

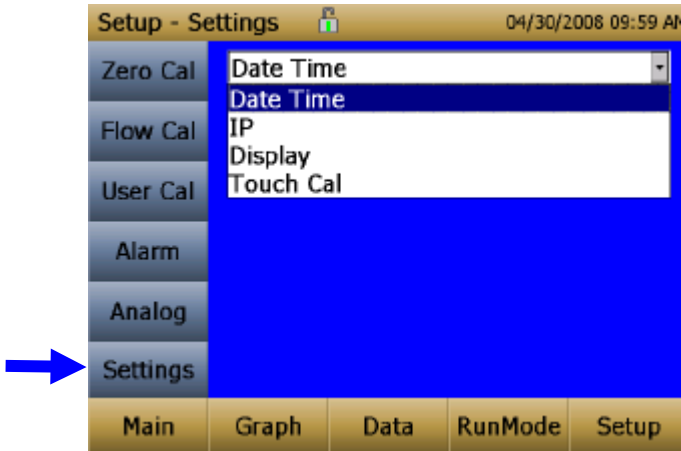

Analog out [On, Off]	Turns analog out port on.
Size Fraction	Selects the size channel that will drive the analog out.
Output Setting [V, mA]	Select between 0 to 5 V and 4 to 20 mA.
Lower Limit [mg/m³]	Mass concentration reading of the selected channel that will correspond to 0 V or 4 mA.
Upper Limit [mg/m³]	Mass concentration reading of the selected channel that will correspond to 5 V or 20 mA.

Settings

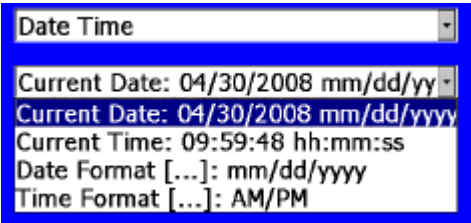

Settings screen sets basic unit parameters.

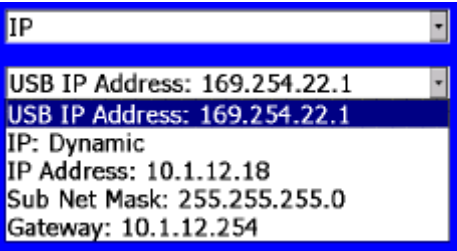
Date Time	 <p>Sets current date, current time and date/time format. Time can be set in 12 or 24 hour format. Date can be set in yyyy/dd/mm, yyyy/mm/dd or yyyy/dd/mm.</p>
------------------	--

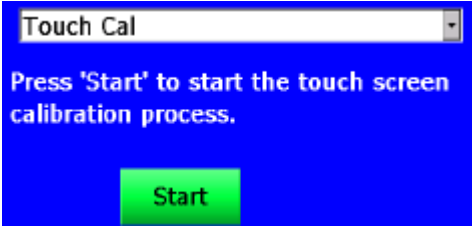
<p>IP</p>	 <p>USB PORT IP Address: USB IP is the address assigned to the instrument by the NDIS driver. It is shown but cannot be changed.</p> <p>Ethernet Port IP parameters: (Model 8533 Desktop only.) IP method can be set to static or dynamic. For static IP, IP address, default gateway, and subnet mask can be set. For Dynamic, The IP assigned by the network is shown. This cannot be changed. See Note below.</p>
<p>Display</p>	 <p>Switches between blue and white backgrounds.</p>
<p>Touch Cal</p>	 <p>Calibrates the touch cal screen.</p>

IP Notes
<p>After changing the instrument to Dynamic or Static, the instrument must be rebooted.</p> <p>In Dynamic Mode, the unit will show the IP to which is assigned (after being rebooted).</p>

Run Mode

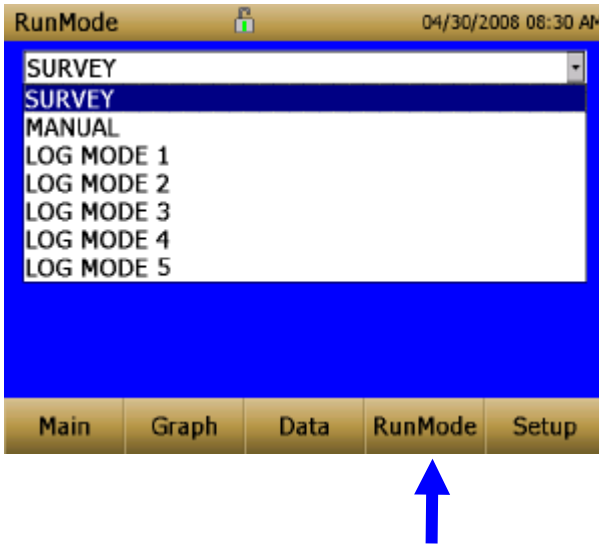

The **RunMode** tab brings up sampling mode options.

Sampling mode options include **Survey Mode**, **Manual Log**, and **Log Mode 1-5**.

Survey	Survey Mode runs a real time, continuous active sample, but does not log data.
Manual	Manual Log sets the instrument to log data for a specified run time
Log Modes	Log Mode starts and stops the instrument at specified times, run for a specified test length, and perform multiple tests of the same length with a specified time period between tests.

Survey Mode

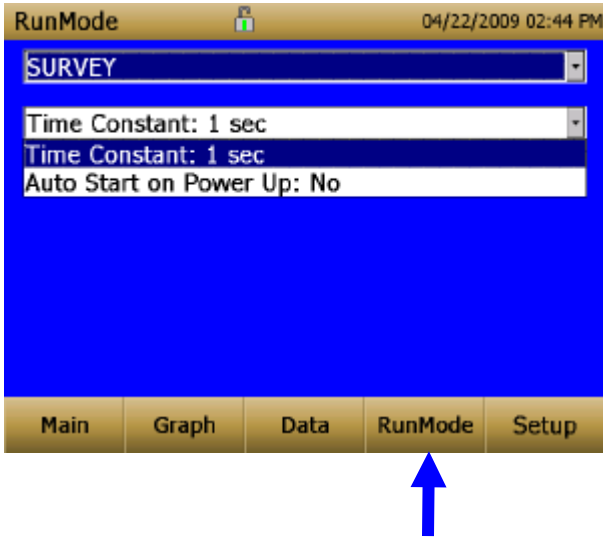

Time Constant	Time Constant can be set from 1 to 60 seconds. This will control the update rate of the main screen. It is the rolling average of data displayed on the main screen and is not linked to logged data in either Manual or Program Log modes.
Auto Start on Power Up	When set to “Yes”, unit will start a measurement upon being powered on, if the unit was set to “Survey” when it was turned off. When set to “No”, the unit will be in idle when it is powered on.

Manual Mode

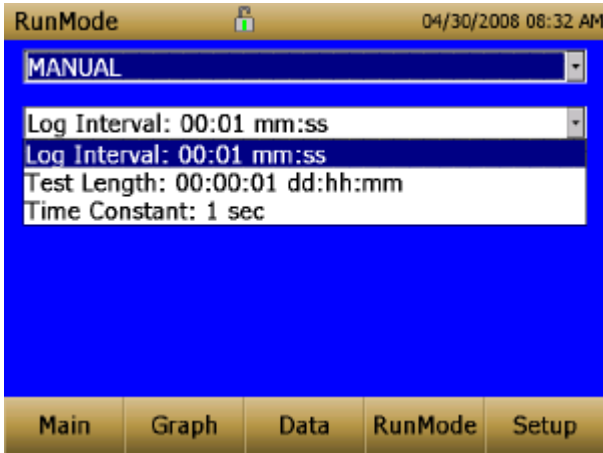

Log Interval	The log interval can be set from 1 second to 60 minutes. It is the amount of time between logged data points.
Test Length	Test length can be set from 1 minute to the limit of the data storage.
Time Constant	Time Constant can be set from 1 to 60 seconds. This will control the update rate of the main screen. It is the rolling average of data displayed on the main screen and is not linked to logged data in either Manual or Program Log modes.

In Manual mode, data will be stored to a file named “*Manual_XYZ*” where *XYZ* is an incrementing integer.

Log Mode (1–5)

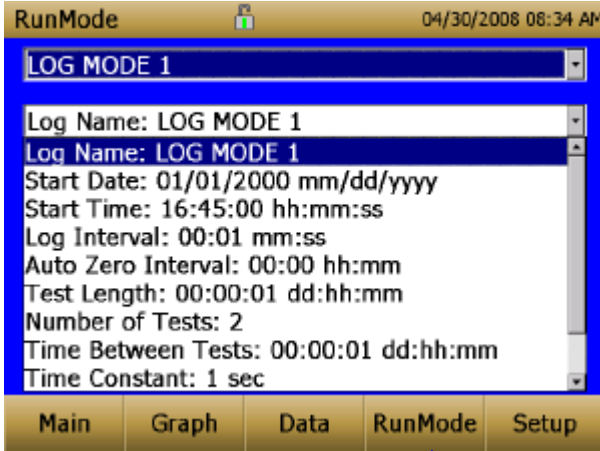

Log Name	Log Name, brings up a virtual keypad to name the Logged Data file.
Start Date	Start Date, select the date the test will start.
Start Time	Start Time, select the time the test will start.
Log Interval	The log interval can be set from 1 second to 60 minutes. It is the amount of time between logged data points.
Auto Zero Interval	Interval between re-zeroing the instrument using the Auto-Zero accessory. Model 8533 desktop only.
Test Length	From 1 minute to the limit of the data storage.
Number of Tests	Number of tests, 1 to 999.
Time between Tests	Time between tests, 1 minute to 30 days.
Time Constant	Time Constant can be set from 1 to 60 seconds. This will control the update rate of the main screen. It is the rolling average of data displayed on the main screen and is not linked to logged data in either Manual or Program Log modes.

Use Start Date	Use Start Date, option to use programmed start date or by pass programmed start date.
Use Start Time	Use Start Time, option to use programmed start time or bypass programmed start time.

In Log mode, data will be stored to a file named “LogName_XYZ” where LogName is the user entered log name and XYZ is an incrementing integer.

Taking Mass Concentration Measurements

Measurements are started and controlled from the main screen.

Prior to starting a measurement the instrument should be zeroed from the **Setup** screen and the run mode should be configured and selected from the **RunMode** screen.

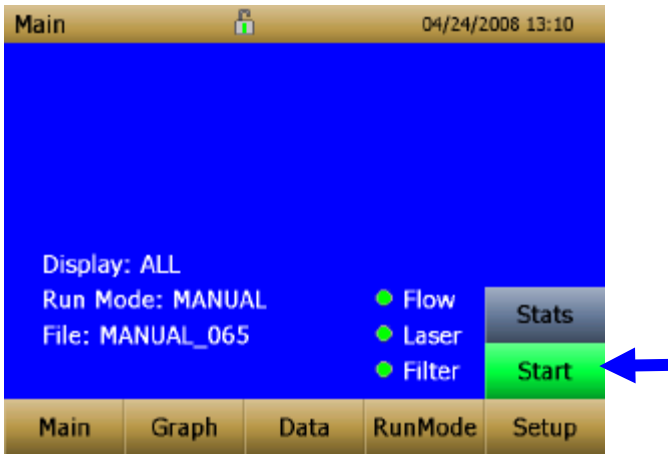

When the instrument is on, but not taking any mass measurements the start button will be green and instruments pump will not be running. To start taking a measurement, press the green **Start** button.

While taking a measurement the screen will display the current measured mass concentration. The various regions of the screen are shown below.

Screen Regions

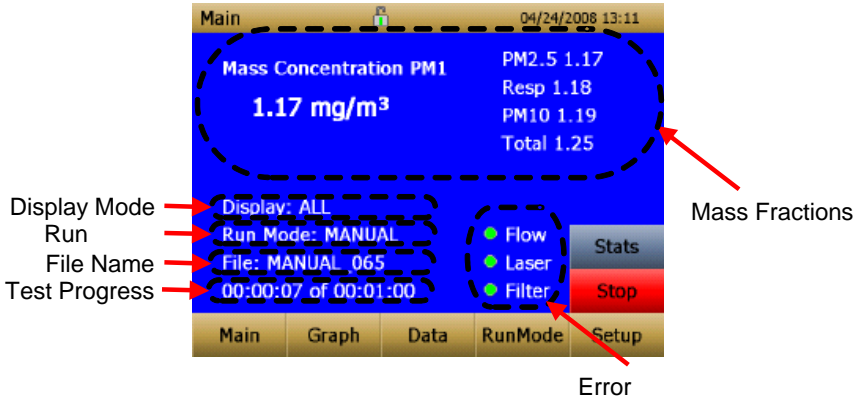

Mass Fractions Region (live keys)	Shows the size segregated mass measurements. The highlighted channel displayed in larger font on the left can be changed by touching on the screen the “measurement of most interest” on the right-hand side of the screen.
Display Mode Region (live key)	The size segregated mass fractions displayed in this area can be selected by touching in the “Display” mode region. The modes that can be selected with this live key are: All: PM ₁ , PM _{2.5} , Resp, PM ₁₀ and Total IAQ-ENV: PM ₁ , PM _{2.5} PM ₁₀ and Total IH: Resp, PM ₁₀ and Total
Run Mode Region	Shows the run mode selected from the RunMode screen.
File Name Region	Displays the file name to which the data is currently being saved.
Test Progress Region	Shows the time-based progress of the test.
Error Indicator Region	Shows the current stats of the instrument Flow: Status of the flow control Laser: Status of the Laser Filter: Status of the Filter See Chapter 5, "Troubleshooting." to resolve any of these error conditions.

Stats

The Stats button will show the statistics of the highlighted channel. To use the stats feature, first select the channel of interest so it is highlighted in large font on the left of the screen.

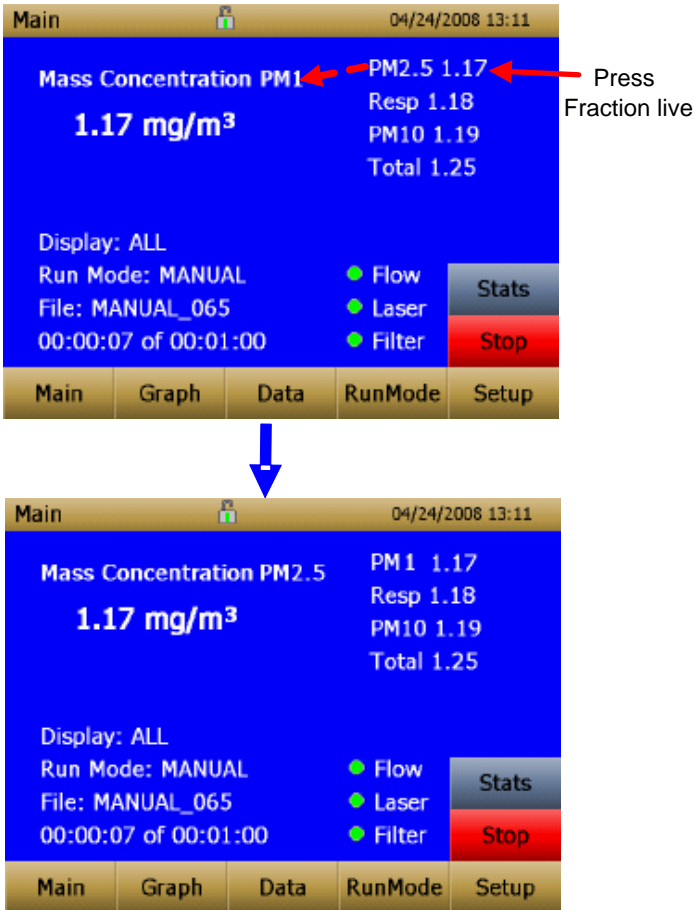

Next, press the Stats button to show the statistics for the highlighted size channel.

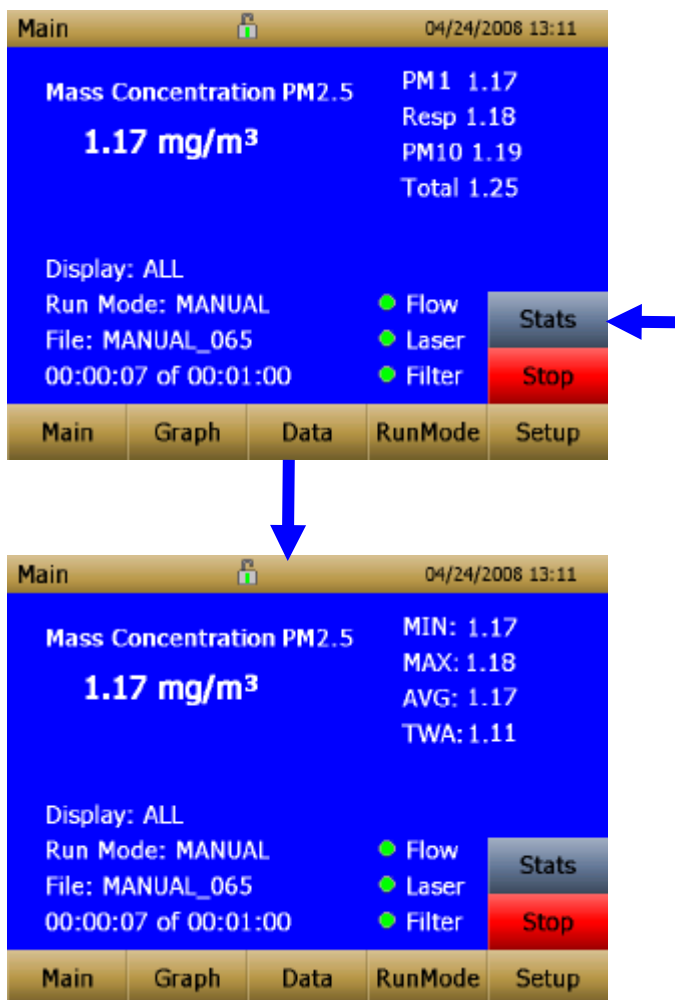



Graphing

During sampling, pressing the **Graph** button displays current readings in graphical form.

- During Survey Mode, five (5) minutes of running real-time data is displayed graphically.
- During Logging Mode, the entire log test time is displayed on the graph.

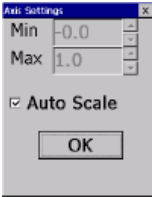

<p>Time Display</p>	<p>Pressing the Time x-axis label on the graph screen switches between Time (s), Time (abs), and Time (rel).</p> <p>Time (s): Elapsed time from first logged point (log interval) to the last logged point (test length).</p> <p>Time (rel): Relative time from zero to last logged point (test length – log interval).</p> <p>Time (abs): Absolute time from first logged point (test start + log interval) to last logged point (test stop).</p>
<p>Scale Display</p>	<p>Pressing in the Scale Display area will bring up a dialog that will allow changing between auto scaling and user scaling of the Y-axis.</p> 

Data Label	Pressing the data label will toggle between PM ₁ , PM _{2.5} , Resp, PM ₁₀ and Total size segregated mass fractions.
Data Region	<p>Pressing the data region will bring up a dialog to show TWA or Average lines.</p>  <p>TWA: Will show a secondary line on the graph showing the time weighted average of the data. This line will not show if test time is less then 15 minutes.</p> <p>Average: Show a secondary line on the graph of the running average of the data.</p>

In Graphing Mode, pressing **Main** returns the instrument to the Main Screen display.

Viewing Data

The **Data** button opens a list of data files for viewing.

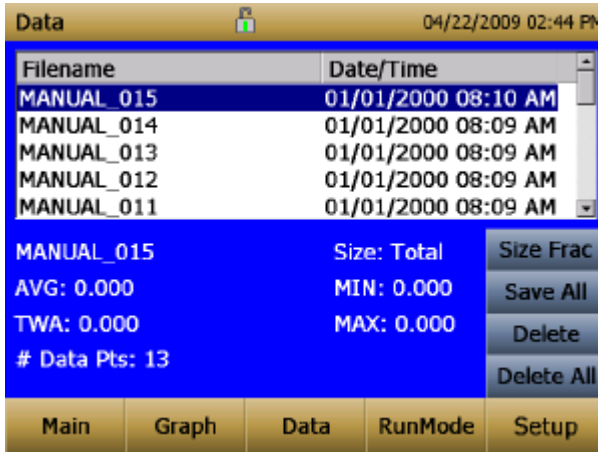





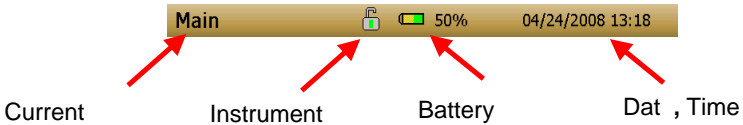

Select File	Press the arrows on the right side of the screen to scroll up or down to the data file to be viewed.
Data Statistics	<p>Statistics on the selected file</p> <ul style="list-style-type: none"> ○ File Name ○ Size Channel ○ Sample Average ○ Sample TWA ○ Sample Maximum Reading ○ Sample Minimum Reading ○ Number of Data Points in the File
Channel Button	Toggles between the mass fraction channels PM ₁ , PM _{2.5} , Resp, PM ₁₀ and Total.
Save All Button	Downloads data to a USB thumb drive. USB thumb drive must be attached to the USB host port. Data is saved as a .csv file that can be viewed in Microsoft [®] Excel [®] spreadsheet software.
Delete Button	Deletes the currently highlighted file.
Delete All Button	Deletes all the files stored on the instrument.

Graph Button	Data can also be viewed in graphical form by pressing the Graph button while the data file is highlighted.
---------------------	---

Title Bar

The Title Bar shows common instrument information.



Current Screen	Title of the current screen that is being displayed.
Instrument Lock	Icon shows if the instrument touchscreen is in a unlocked or locked condition. Unlocked:  Locked:  To lock the touchscreen controls, touch the “lock” icon, immediately followed by three (3) quick touches on the current screen (Main) word along the top tool bar. Repeat the process to unlock the screen.
Battery Status	Show the current % life of the battery and show if the battery is currently being charged: Charging:  (unfilled portion of the icon filled yellow) Not Charging:  (unfilled portion of the icon transparent)
Date and Time	Indicates the instruments current date and time.
Alarm	If the instrument is in a alarm status a alarm icon  will appear in the title bar.

(page intentionally left blank)

Chapter 4

Maintenance

The DUSTTRAK™ DRX aerosol monitor can be maintained in the field using the instructions below. Additionally, TSI recommends that you return your DUSTTRAK™ DRX to the factory for annual calibration. For a reasonable fee, we will quickly clean and calibrate the unit and return it to you in “as new” working condition, along with a Certificate of Calibration. This “annual checkup” helps ensure that the DUSTTRAK™ DRX is always in good operating condition.



WARNING

There are no user-serviceable parts inside this instrument. The instrument should only be opened by TSI or a TSI approved service technician

Maintenance Schedule

Your DUSTTRAK™ DRX Aerosol Monitor requires maintenance on a regular basis. Table 4–1 lists the factory recommended maintenance schedule.

Some maintenance items are required each time the DUSTTRAK™ monitor is used or on an annual basis. Other items are scheduled according to how much aerosol is drawn through the instrument. For example, cleaning the inlet sample tube is recommended after 350 hours of sampling a 1 mg/m³ concentration of aerosol. This recommendation should be pro-rated according to how the instrument is used. 350 hours at 1 mg/m³ is the same amount of aerosol as 700 hours at 0.5 mg/m³ or 175 hours at 2 mg/m³, etc.

Table 4–1. Recommended Maintenance Schedule

Item	Frequency
Perform zero check	Before each use.
Clean inlet	350 hr. at 1 mg/m ³ *
Clean 2.5 µm calibration impactor	Before every use.
Replace internal filters	350 hr. at 1 mg/m ³ * or when indicated by the main screen filter error indicator.
Return to factory for cleaning and calibration	Annually

*Pro-rated, see discussion above.

The DUSTTRAK™ monitor keeps track of the accumulated amount of aerosol drawn through it since its last cleaning. When the internal filter replacement is due, the filter error indicator will turn from green to red.

TSI recommends that you perform a zero check prior to each use for the DUSTTRAK™ monitor and certainly before running any extended tests, and after the instrument experiences a significant environmental change. Examples of significant environmental changes would be ambient temperature changes that exceed 15°F (8°C) or moving from locations with high aerosol concentrations to low concentrations.

Zeroing Instrument

1. Attach the zero filter to the inlet of the instrument.



Figure 4-1: Attach Zero Filter to Inlet

2. Follow zero calibration instructions detailed in the operations section of this manual,

Cleaning the Inlet

The inlet should be cleaned based on the schedule in Table 4–1.

1. Turn the DUSTTRAK™ monitor off.
2. Unscrew the inlet nozzle from the instrument (Figure 4-2).

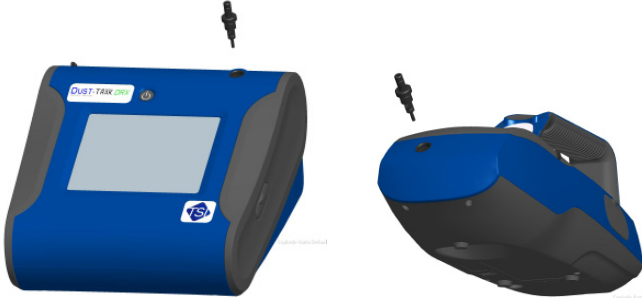

Figure 4-2: Unscrew Inlet Nozzle

3. Clean the inlet port. A cotton swab can be used to clean the outside of the inlet port. The swabs can be dampened with water or a light solvent (e.g., isopropanol). The inside of the sample tube can be cleaned using a small brush, along with a light solvent. Dry the tube by blowing it out with compressed air, or let it air-dry thoroughly.

Note
Be careful not to blow particles into the DUSTTRAK™ monitor inlet port.

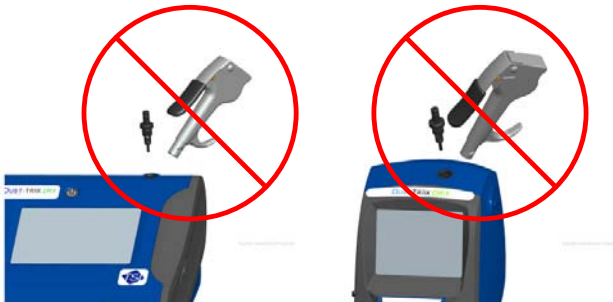

Figure 4-3: Do NOT Blow into Instrument

4. Screw (hand-tighten) inlet back into instrument.

Cleaning 2.5 μm Calibration Impactor

The calibration impactor should be cleaned prior to every use, using it to perform a Standard Calibration (size correction) on the instrument, as described in the [Operations](#) section.

1. Unscrew Impactor. Check O-ring on the impactor base.
2. Clean outside and inside of Impactor and the impactor plate using a clean brush and a light solvent. Dry impactor parts by blowing it out with compressed air, or let it air-dry thoroughly.
3. Apply 2 drops of oil (included) to the impactor plate. Do *not* over-fill impaction plate.

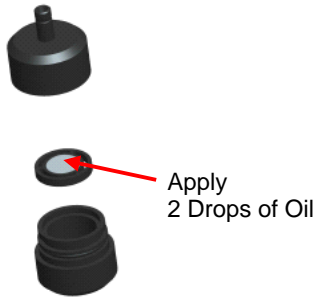

Figure 4-4: Apply 2 Drops of Oil to Impactor Plate

4. Screw (hand-tighten) impactor back together.

Replacing the Internal Filters

The internal filters should be replaced based on the schedule in Table 4–1 or when the filter indicator on the main screen changes to red.

1. Turn the instrument off.
2. Remove old filters from the instrument.

Handheld Model

- a. Use the enclosed filter removal tool (PN 801668) tool to unscrew the two filter caps located on the bottom of the instrument.
- b. Pull the old filters out of the two filter wells. If filter wells are visibly dirty, blow out with compressed air.



Figure 4-5: Pull Filters Out of Two Filter Wells (Handheld Model)

- c. Put two (2) new filters into the filter wells and screw filter caps back into place.

Note
Replacement filters were shipped with the new instrument. Additional filters can be ordered from TSI under PN 801666.

Desktop Model

- a. Open filter access door on the back of the instrument.
- b. Use the enclosed filter removal tool (PN 801668) to unscrew the filter cap.
- c. Pull out single cylindrical filter from filter well. If filter well is visibly dirty, blow out with compressed air.

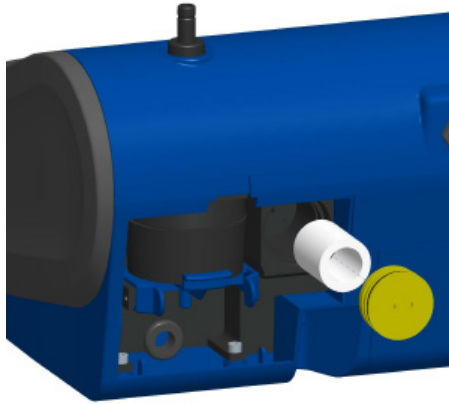

Figure 4-6: Pull out Single Cylindrical Filter from Filter Well (Desktop Model)

- d. Put a new filter (P/N 801673) back into filter well and screw filter cap back into place.

- e. Open blue retention clip by pinching ends inward and pushing down.

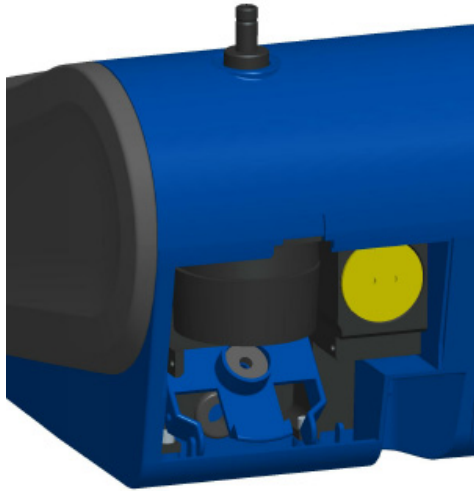

Figure 4-7: Open Blue Retention Clip

- f. Remove 37-mm filter cassette by pulling downward and outward.

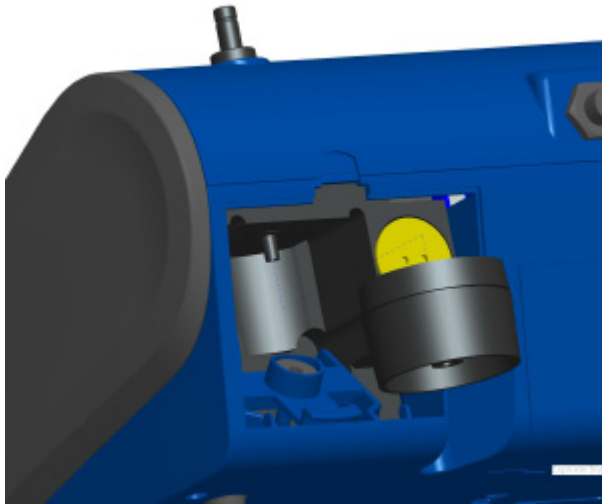

Figure 4-8: Remove 37-mm Filter Cassette

- g. Open filter cassette using enclosed tool PN 7001303.

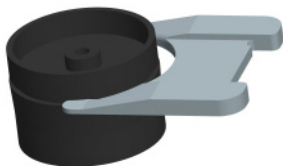

Figure 4-9: Open Filter using Enclosed Tool

- h. Remove screen mesh from filter cassette and blow out using compressed air. Blow in reverse direction to remove captured particulate.
- i. Replace mesh in filter cassette and press halves together. Ensure filter has been fully closed. The filter tool PN 7001303 can be used to ensure the filter is fully closed.



Figure 4-20: Replace Mesh in Filter Holder

- j. Place filter cassette back into position and close blue retaining clip. Make sure retaining clip snaps back into place.

Notes
Replacement filters were shipped with the new instrument. Additional filters (HEPA and 37-mm Filter Cassette with mesh filter) can be order from TSI under PN 801673. TSI does not supply any filter media for the filter cassette. Any commercially available 37-mm filter media may be used with the DUSTTRAK™ II or DRX desktop instruments to collect gravimetric reference samples.

- 3. **It is important to reset the instruments filter counter after replacing filters. Resetting the counter will clear the filter error condition shown on the main screen.** Reset the counters by the following:
 - a. Turn on the instrument.
 - b. Press the **Setup** button to go into the setup screen.

- c. Touch the **Cum Filter Conc:** (live key) to reset the aerosol mass.

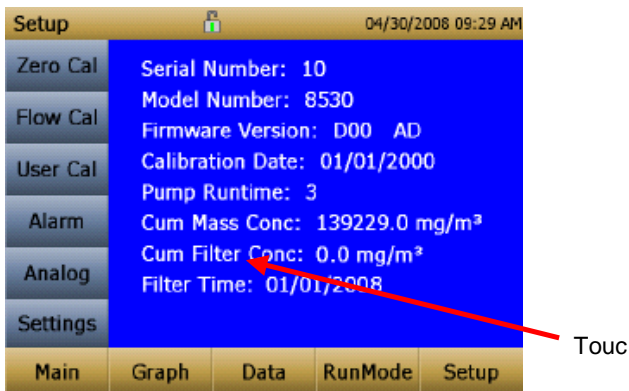

- d. *Replace user serviceable filters?* Dialog will appear. Press **OK**.
- e. *Reset filter concentration?* Dialog will appear. Press **Yes** to reset the cumulative filter concentration to zero.
- f. The Setup screen will not show zero for the **Cum Filter Concentration** and the current date for the **Filter Time**.

Storage Precautions

When storing the DUSTTRAK™ monitor for more than 30 days, you should charge and remove the batteries. This prevents damage due to battery leakage.

This instrument must be stored in a location where the temperature remains between -20 and 60°C (-4 and 140°F).

(This page intentionally left blank)

Chapter 5

Troubleshooting

The table below lists the symptoms, possible causes, and recommended solutions for common problems encountered with the DUSTTRAK™ DRX monitor.

Symptom	Possible Cause	Corrective Action
Erratic zero reading.	Leak. Dirty inlet port and/or sample tube. Internal filter(s) not installed properly (leaking).	Check connections for leaks. Replace zero filter. Clean inlet port. Clean or replace tubing. Inspect internal filter wells to make certain the filters and o-rings are seated properly. Replace internal filters if necessary.
Run Mode Error: The start time has passed Run Mode Error: The selected log mode will exceed the allowed number of samples	The selected Run Mode program has “Use Start Date” selected, but the start date is prior to the current date. The selected Run Mode program is programmed to save more samples than is room in memory.	Correct or change the run mode program. Reduce the number of samples by reducing the test length or increasing the logging interval.

Symptom	Possible Cause	Corrective Action
Instrument runs slow	Large amount of data in memory	Large data files or many small data files will cause instrument to slow, due to need to read and display large amounts of data.
No display.	Unit not switched on. Low or dead batteries.	Switch unit on. Recharge the batteries or plug in the AC adapter.
No touch - screen response.	Instrument currently busy Instrument Touchscreen is locked	The instrument will take time to open large data files and save configuration information. During this time, the instrument will not respond to additional touch-screen touches. If the lock in the title bar is red, unlock the instrument following the instructions in the Chapter 3, Operation: Title Bar section of this manual.
Analog output does not work	Cable/connector not correctly installed. Output wired with reverse polarity.	Make sure cable connector is fully seated. Make sure analog out (+) and analog ground (-) are wired correctly to data-logger.
Analog output is not in proportion to display	Analog output range in DUSTTRAK™ monitor may be set incorrectly. Data logger scaling factor may be set incorrectly.	Check analog output setting in the Setup->Analog screen. Make sure the channel of interest is selected. Make sure that the correct output (0 to 5V, 4 to 20 mA) is selected. Review the scaling factor set in the Setup-Analog screen.

Symptom	Possible Cause	Corrective Action
Alarm output does not work.	Alarm function not turned on.	Turn the alarm function on in the Settings->Alarm screen.
Alarm does not turn on correctly.	Alarm setting incorrect.	Check the alarm settings in the Settings->Alarm screen.
	Alarm output wired with reverse polarity.	Alarm wires are polarized. Voltage input must be wired to alarm input (+).
Instrument does not store new data	Memory is full.	Delete or transfer historic data.
	Instrument is in Survey mode.	The instrument does not store data in survey mode. Can to manual or program log mode.
Flow Error is indicated on front screen	If sampling from a duct, instrument may have problems overcoming pressure differences.	Attach both the input and the exhaust port into the duct.
	Flow obstruction.	Remove obstruction if still present. Press any key to bypass.
	Internal pump failing, indicated by inability to adjust flow rate to full range.	Factory service may be required.
	Filter Cassette clogged or has mass loading.	Replace the filter cassette. See the maintenance section of the manual.
Laser Error indicated on front screen	Laser background is too high.	Remove and clean inlet nozzle. Pay close attention to the tip of the nozzle that is inserted into the instrument to ensure it is clear of any contamination.
	Laser is failing.	Factory service may be required.

Symptom	Possible Cause	Corrective Action
Filter Error indicated on front screen.	Filters need to be replaced	Replaced the filters per instructions in the maintenance section of this manual. Make sure to reset the filter mass and date once the filters have been changed.

Appendix A

Specifications

Specifications are subject to change without notice.

Sensor Type	90° light scattering
Range	8533 Desktop 0.001 to 150 mg/m ³ 8534 Handheld 0.001 to 150 mg/m ³
Display	Size Segregated Mass Fractions for PM ₁ , PM _{2.5} , Respirable, PM ₁₀ and Total. All displayed
Resolution	±0.1% of reading of 0.001 mg/m ³ , whichever is greater
Zero Stability	±0.002 mg/m ³ 24 hours at 10 sec time constant
Particle Size Range	Approximately 0.1 to 15 µm
Flow Rate	3.0 L/min
Flow Accuracy	±5% Internal flow controlled
Temperature Coefficient	+0.001 mg/m ³ per °C
Operational Temp	0 to 50°C
Storage Temp	-20 to 60°C
Operational Humidity	0-95% RH, non-condensing
Time Constant	Adjustable 1 to 60 seconds
Data Logging	<45 days at 1 minute samples
Log Interval	1 second to 1 hour
Physical Size (HWD)	Handheld: 4.9 x 4.75 x 12.45 in. Desktop: 5.3 x 8.5 x 8.8 in.
Weight	Handheld: 2.9 lb, 3.3 lb with battery Desktop: 3.45 lb, 4.45 lb – 1 battery, 5.45 lb – 2 batteries
Communications	8533: USB (Host and Device) and Ethernet. Stored data accessible using thumb drive 8534: USB (Host and Device). Stored data accessible using thumb drive.
Power—AC	AC power adapter included. 115 to 240 VAC

Battery	<p>8533: Up to 2 Removable Li-Ion External and Internal charging Life, 1 battery: >6.5 hours (9 hours typical for a new battery) Life, 2 battery: >13 hours</p> <p>8534: 1 Removable Li-Ion External and Internal charging Life: 6 hours typical</p>
Analog out	<p>8533 User selectable output 0 to 5 V or 2 to 20 mA User selectable scaling</p>
Alarm Out	<p>8533: STEL Relay or sound buzzer Relay No latching MOSFET User selectable set point 5% deadband Connector 4-pin, Mini-DIN connectors</p> <p>8534: Sound buzzer</p>
Screen	<p>8533: 5.7" color touchscreen 8534: 3.5" color touchscreen</p>
Gravimetric Sampling	<p>8533: Removable 37 mm Cartridge</p>
EMI/RF Immunity:	<p>Complies with Emissions Directive Standard: EN50081-1:1992 Complies with Immunity Directive Standard: EN50082-1:1992*</p>

*ESD Shock may require instrument reboot

Appendix B

DRX Advanced Calibration

The advanced calibration method is employed to yield high size segregated mass concentration accuracy for PM_{1.0}, PM_{2.5}, Respirable and PM₁₀ size fractions. It involves two gravimetric measurements to obtain PCF and SCF. The two gravimetric measurements can be done in sequence or in parallel, depending on the gravimetric sampling device availability.

Option 1: Serial Gravimetric Calibration

When the user has only one set of gravimetric sampling devices, the DUSTTRAK™ DRX advanced calibration can be performed in two serial steps. The experimental setup is in Figure B-1a. The calibration steps are outlined below:

Step 1: PCF Calibration

- Install a PM_{2.5} impactor at the inlet of the external gravimetric filter.
- Co-locate and run the gravimetric sample and DUSTTRAK™ DRX monitor simultaneously to collect enough mass on the gravimetric filter.
- Calculate the PM_{2.5} mass concentration (PM_{2.5_Grav}) from the gravimetric filter based on the net mass collected on the filter, sampling time, flow rate, and total liters of air sampled.
- Read the DUSTTRAK™ DRX monitor average PM_{2.5} mass concentration (PM_{2.5_DRX}) from the screen or through TRAKPRO™ Data Analysis Software.
- Calculate the new PCF

$$PCF_{New} = \frac{PM_{2.5_Grav}}{PM_{2.5_DRX}} \times PCF_{Old}$$

- Update the new PCF in user calibration settings.

Step 2: SCF Calibration

- Install a PM₁₀ impactor at the inlet of the external gravimetric filter.
- Co-locate and run the gravimetric sample and DUSTTRAK™ DRX monitor simultaneously to collect enough mass on the gravimetric filter.
- Calculate the PM₁₀ mass concentration (PM_{10_Grav}) from the gravimetric filter based on the net mass collected on the filter, sampling time, flow rate, and total liters of air sampled.
- Read the DUSTTRAK™ DRX monitor average PM_{2.5} (PM_{2.5_DRX}) and PM₁₀ (PM_{10_DRX}) mass concentration from the screen or through TRAKPRO™ Data Analysis Software.
- Calculate the new SCF

$$SCF_{New} = \left(\frac{PM_{10_Grav} - PM_{2.5_DRX}}{PM_{10_DRX} - PM_{2.5_DRX}} \right)^{\frac{1}{3}} \times SCF_{Old} .$$

- Update the new SCF in user calibration settings.

Option 2: Parallel Gravimetric Calibration

When the user has two sets of gravimetric sampling devices, the DUSTTRAK™ DRX monitor advanced calibration can be performed in the parallel configuration as shown in Figure B-1b. The calibration steps are outlined below:

1. Install a PM_{2.5} and a PM₁₀ impactor at the inlet of the two external gravimetric filters, respectively.
2. Co-locate and run the gravimetric samples and DUSTTRAK™ DRX monitor simultaneously to collect enough mass on the gravimetric filters.
3. Calculate the PM_{2.5} (PM_{2.5_Grav}) and PM₁₀ (PM_{10_Grav}) mass concentrations from the gravimetric filters based on the net mass collected on the filter, sampling time, flow rate, and total liters of air sampled.
4. Read the DUSTTRAK™ DRX monitor average PM_{2.5} and PM₁₀ mass concentration (PM_{2.5_DRX} and PM_{10_DRX}) from the DRX screen or through TRAKPRO™ Data Analysis Software.

5. Calculate the new PCF

$$PCF_{New} = \frac{PM_{2.5_Grav}}{PM_{2.5_DRX}} \times PCF_{Old} ,$$

and the new SCF

$$SCF_{New} = \left(\frac{PM_{10_Grav} - PM_{2.5_Grav}}{PM_{10_DRX} - PM_{2.5_DRX}} \right)^{\frac{1}{3}} \times SCF_{Old} .$$

6. Update the new SCF and PCF in the user calibration settings.

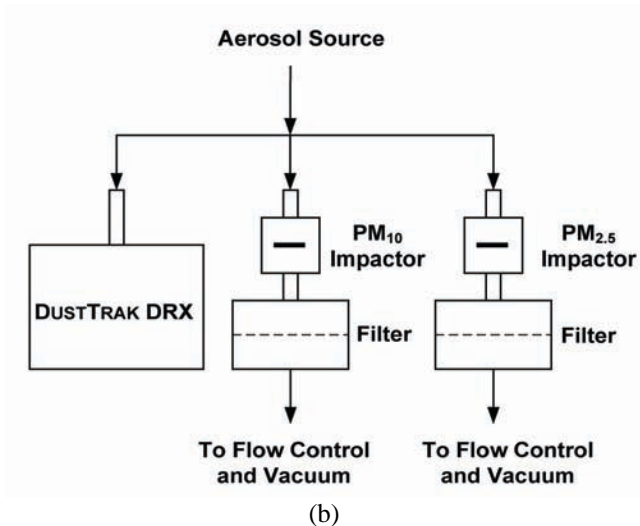
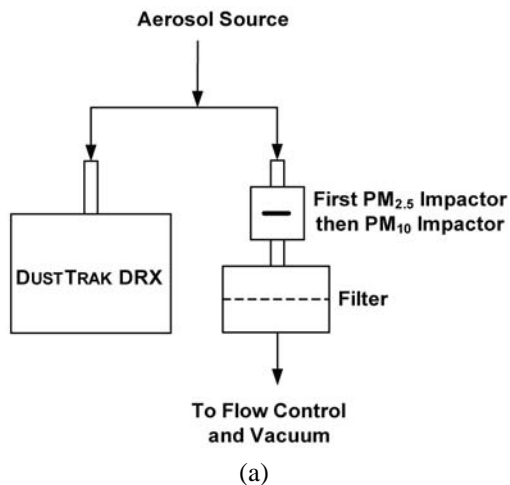

**Figure B-1: Experimental Setup for
(a) Serial and (b) Parallel Gravimetric Calibration**

(page intentionally left blank)

Appendix C

Zero Module

The Zero Module (PN 801690) allows for automatic re-zeroing of the DUSTTRAK™ Instrument during long sampling runs. The Zero Module works only with the 8533 desktop model.

The AutoZero module is attached to the main instrument in two steps. The first step is to place the Zero module over the instrument's inlet and press down. The Zero module has an O-ring seal that will engage with the instrument's inlet.

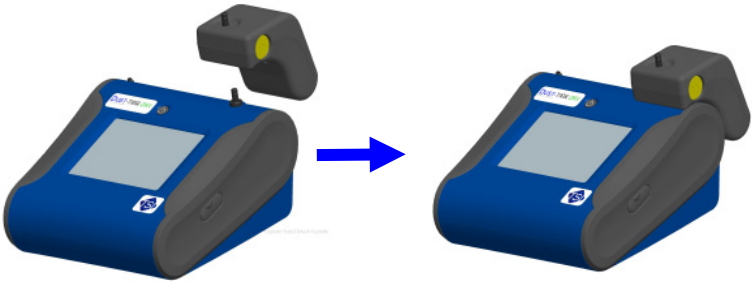

Figure C-1: Place Zero Module Over Inlet and Press Down

The second step is attaching the cable from the Zero module to the Zero module connector located on the back of the instrument.



Figure C-2: Zero Module Connector

The Zero Module can only be used in a program log mode. The Zero module function is controlled through these two program mode options:

Auto Zero Interval	Interval between re-zeroing the instrument using the Auto-Zero accessory.
Use Auto Zero	Select Yes to use the Zero Module. Select No to not use the Zero Module.

Important points on Zero Module operation:

- The Zero module will take 1 minute to take a zero reading. The first 45 seconds of that period is used to clear the chamber of particles. Readings from last 15 second of the period, when the chamber is cleared of particles, will be averaged to determine the Zero offset.
- The log interval, when the Zero module is activated, must be 2 minutes or greater. Data will not be recorded to the log file when the Zero module is activated.

Index

4

4-pin miniDIN connector, 10

A

AC adapter, 8
advanced calibration, 59
advisory labels, iv
aerosol monitor
 maintenance, 43
 specifications, 57
 troubleshooting, 53
alarm, 24, 41
 audible, 26
 relay1, 25
 STEL 1, 25
 visible, 26
 wiring, 11
alarm1 setpoint, 25
alarm2 enable, 25
alarm2 setpoint, 25
analog, 27
 lower limit, 27
 out, 27
 output setting, 27
 size fraction, 27
 upper limit, 27
analog output
 wiring, 10
analog/alarm cable, 2
analog/alarm output
 connecting, 10
audible, 26
auto start on power up, 31
auto zero interval, 64

B

battery
 charging, 8
battery installation, 7
 desktop unit, 7
 handheld unit, 8
battery status, 41

C

calibration certificate, 2
calibration date, 14
calibration factor
 for specific aerosol, 22
calibration impactor
 cleaning, 46
calibration impactor kit, 3
caution symbols, iv
channel button, 40
charging battery, 8
Class I, iii
clean inlet, 43
cleaning
 inlet conditioner, 45
conductive tubing, 3
connecting
 analog/alarm output, 10
connecting computer, 9
current screen, 41
custom cal, 19

D

data, 40
 channel button, 40
 delete, 40
 save all button, 40
 select file, 40
 statistics, 40
delete, 40
determining calibration factor for
 specific aerosol, 22
display mode region, 35

E

error indicator region, 35
Ethernet port IP parameters, 29

F

file name region, 35
filter cassette, 49, 50
 troubleshooting, 55
filter opening tool, 3
filter removal tool, 3

- filter time, 14
- firmware version, 14
- flow cal, 16
- flow error, 55

G–H

- graph, 38
 - button, 41
 - data label, 39
 - data region, 39
 - scale display, 38
 - time display, 38
- gravimetric sample, 20

I–J–K

- impactor oil, 4
- inlet cap, 4, 8
- inlet conditioner
 - cleaning, 45
- installing batteries, 7
- instrument lock, 41
- instrument setup, 9
- internal filer
 - replacing, 43
- internal filter, 3
 - replacing, 47
- internal filter element, 3
- internal gravimetric filter, 23

L

- laser error, 55
- laser radiation label, iv
- log interval, 32, 33
- log mode, 30, 33
 - auto zero interval, 33
 - log interval, 33
 - log name, 33
 - number of tests, 33
 - start date, 33
 - start time, 33
 - test length, 33
 - time between tests, 33
 - time constant, 33
 - use start date, 34
 - use start time, 34
- log modes, 30
- log name, 33

M

- maintenance, 43
 - schedule, 43
- manual log, 30
- manual mode, 32
 - log interval, 32
 - test length, 32
 - time constant, 32
- mass concentration measurements, 34
- mass fractions region, 35
- model number, 14

N–O

- name, 17
- newcal, 23
- number of tests, 33

P–Q

- packing list, 1
- parallel gravimetric calibration, 60
- parts identification, 5, 6
- PCF calibration, 59
- photometric, 17, 23
- power supply, 4
- pump run time, 14

R

- rechargeable battery, 2
- relay1, 25
- replacing internal filter, 47
- reusing and recycling, v
- run mode region, 35
- runmode, 30

S

- safety information, iii
- save all button, 40
- SCF calibration, 59
- screen regions, 35
- screwdriver, 4
- select file, 40
- serial gravimetric calibration, 59
- serial number, 14
- serial number label, iv
- service policy, 2
- setting up, 7
 - instrument, 9

- settings, 28
 - date time, 28
 - display, 29
 - IP, 29
 - touch cal, 29
- setup menu, 14
 - calibration date, 14
 - cum filter conc, 14
 - cum mass conc, 14
 - filter time, 14
 - firmware version, 14
 - model number, 14
 - pump run time, 14
 - serial number, 14
- size corr, 18
- size fraction, 27
- software
 - installation, 9
- spanner driver, 3
- specifications, 57
- standard calibration method-
 - photometric calibration
 - factor, 21
- standard calibration method-size
 - correction factor, 18
- start date, 33
- start time, 33
- start up, 13
- START UP screen, 13
- stats, 36
- STEL, 26
 - alarm repeat, 26
 - data, 26
 - indicator, 26
- STEL 1, 25
- storage precautions, 51
- stylus, 4
- supplying power, 7
- survey mode, 30, 31
 - time constant, 31

T

- test length, 32
- test progress region, 35

- time between tests, 33
- time constant, 31, 32, 33
- title bar, 41
 - alarm, 41
 - battery status, 41
 - current screen, 41
 - date and time, 41
 - instrument lock, 41
- TRAKPRO™ software
 - installation, 9
- troubleshooting, 53

U

- unpacking, 1
- USB cable, 2
- USB port
 - connector, 9
- USB port IP address, 29
- use auto zero, 64
- use start date, 34
- use start time, 34
- user cal, 17, 18
 - name, 17
 - photometric, 17
 - size corr, 18

V

- visible, 26

W-X-Y

- warning symbols, iv
- warranty, 2
- wiring alarm, 11
- wiring analog output, 10

Z

- zero cal, 15
- zero check, 43
- zero filter, 2, 44
- zero module, 63
- zeroing instrument, 44

TSI Incorporated – 500 Cardigan Road, Shoreview, MN 55126 U.S.A

USA	Tel: +1 800 874 2811	E-mail: info@tsi.com	Website: www.tsi.com
UK	Tel: +44 149 4 459200	E-mail: tsiuk@tsi.com	Website: www.tsiinc.co.uk
France	Tel: +33 491 11 87 64	E-mail: tsifrance@tsi.com	Website: www.tsiinc.fr
Germany	Tel: +49 241 523030	E-mail: tsigmbh@tsi.com	Website: www.tsiinc.de
India	Tel: +91 80 41132470	E-mail: tsi-india@tsi.com	
China	Tel: +86 10 8251 6588	E-mail: tsibeijing@tsi.com	
Singapore	Tel: +65 6595 6388	E-mail: tsi-singapore@tsi.com	



Contact your local TSI Distributor or visit our website www.tsi.com for more detailed specifications.