

# Panel-mounted thermostats EM

with 1, 2, 3, or 4 single-pole snap-action switches

**PED** Pressure  
Equipment  
Directive

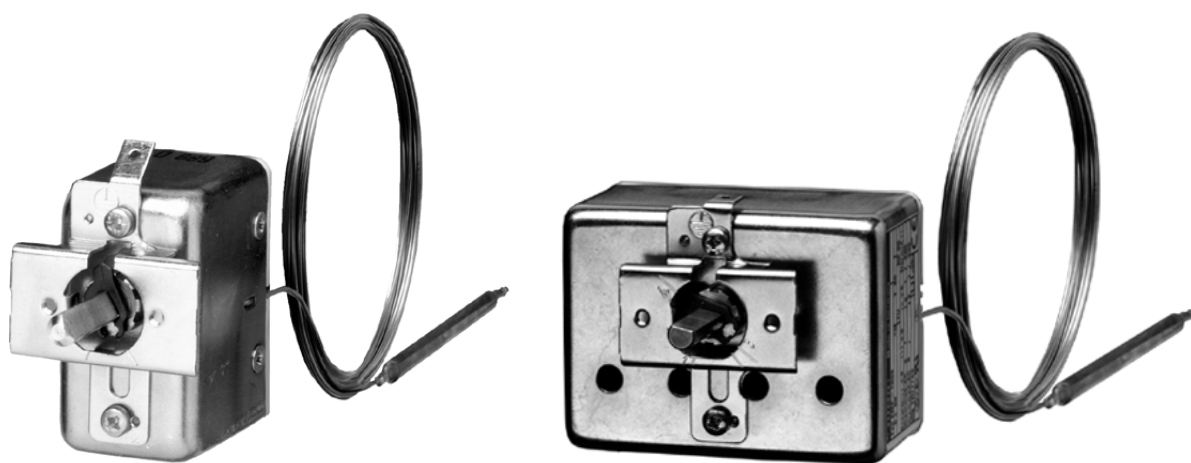

Operating Manual



60202100T90Z003K000

V5.01/EN/00073772/2023-06-01



<b>1</b>	<b>About this documentation</b>	<b>5</b>
1.1	Symbols	5
<b>2</b>	<b>Introduction</b>	<b>6</b>
2.1	Brief description	6
2.2	Intended use	6
<b>3</b>	<b>Identifying the device version</b>	<b>8</b>
3.1	Nameplate	8
3.2	Order details	9
<b>4</b>	<b>Mounting</b>	<b>12</b>
4.1	Dimensions	12
4.2	Fixing the panel-mounted thermostat	16
4.2.1	Mounting the switching head	16
4.3	Capillary, temperature probe and thermowell	17
4.3.1	General information	17
4.3.2	Approved process connections	18
4.4	Permissible pressure at the thermowell	19
4.4.1	Thermowells 20, 22/23, 40, and 41/42	19
<b>5</b>	<b>Installation</b>	<b>23</b>
5.1	Installation notes	23
5.2	Electrical connection	23
5.3	Connection diagram	25
<b>6</b>	<b>Settings</b>	<b>26</b>
6.1	Unlocking the TB or STB	26
6.2	Setpoint adjustment	27
<b>7</b>	<b>Technical data</b>	<b>28</b>
7.1	Control ranges and probe table	28
7.2	Control ranges and temperature probes	29
7.3	Capillary and temperature probe	29
7.4	Electrical data	30
7.5	Operating data	31
7.6	Housing	33
7.7	Process connection	33
7.8	Approvals	34

---

# Contents

---

<b>8</b>	<b>Shutdown</b> .....	<b>36</b>
8.1	Maintenance .....	36
8.2	Cleaning .....	36
8.3	Dismounting .....	36
8.4	Returns .....	36
8.5	Disposal .....	36
<b>9</b>	<b>Declaration of conformity</b> .....	<b>37</b>
<b>10</b>	<b>China RoHS</b> .....	<b>42</b>

## 1.1 Symbols



### **WARNING!**

The signal word **"WARNING"** indicates an imminent danger.

Non-observance can lead to death or serious injury.

- ▶ The instructions in the warning notice must be observed and followed!
- 



### **CAUTION!**

The signal word **"CAUTION"** indicates an imminent danger.

Non-observance can lead to minor or moderate injury.

- ▶ The instructions in the warning notice must be observed and followed!
- 

### **NOTICE!**

The signal word **"NOTICE"** indicates possible damage to property.

Non-observance can lead to damage to devices, systems or the environment.

- ▶ Observe the instructions in the note for avoiding damage!
-

## 2 Introduction

---

### 2.1 Brief description

Thermostats control and monitor thermal processes. The devices of the EM series are available as temperature controllers TR, temperature monitors TW, temperature limiters TB, safety temperature monitors STW (STB), and safety temperature limiter STB. In the event of a malfunction, the STB switches the monitored machine to a safe operating status.

Panel-mounted thermostats operate according to the fluid expansion principle – a microswitch is used as an electrical switching element.

#### Switching functions

##### **Temperature controller TR, temperature monitor TW, and safety temperature monitor STW**

If the temperature on the temperature probe exceeds the setpoint value, the electrical circuit is opened or closed by a microswitch. If the temperature falls below the selected setpoint value (by the switching differential), the microswitch is reset to its initial position.

##### **Temperature limiter TB and safety temperature limiter STB**

If the temperature at the temperature sensor exceeds the set limit value, the electrical circuit is opened or closed by a microswitch.

After the temperature has fallen below the limit value by approx. 10 % of the scale range (approx. 15 % with setpoint setting >350 °C), the microswitch can be unlocked manually.

For set points above 120 °C, the set point adjusted on the STB must be secured against adjustment (e.g. with a lead seal).

##### **Self-monitoring for safety temperature limiter STB and safety temperature monitor STW (STB)**

If the measuring system is destroyed (i.e. if the expansion fluid escapes) the pressure in the membrane of the STB and STW (STB) drops and permanently opens the electrical circuit. Unlocking is then no longer possible.

When the STW (STB) and STB sensors cool down to the negative temperature range, the circuit 1 to 2 opens, but must be unlocked manually by the restart knob when the temperature rises. The STW (STB) restarts automatically.

##### **Use of the safety temperature monitor STW as a safety temperature limiter STB**

The circuitry used with the thermostat must comply with DIN EN 14597 and VDE 0631.

### 2.2 Intended use

Versions according to DIN EN 14597:

- Temperature controller TR
- Temperature monitor TW
- Temperature limiter TB
- Safety temperature monitor STW (STB)
- Safety temperature limiter STB

Type examination according to:

- DIN EN 14597
- Pressure Equipment Directive (only for types EM-20, EM-30, EM-40, EM-50)
- UL

## 2 Introduction

---

You will find the Declarations of conformity at [www.jumo.en](http://www.jumo.en).

- Products
- Temperature
- Monitor/Limiter
- Electromechanical
- Panel-mounting thermostats 602021
- Documentation
- Declaration of conformity/White Paper

Ask for them to be sent.

Physical and toxicological properties of the expansion fluid that may escape in the event of a system fracture.

Control range with end of scale	Dangerous reactions	Fire and explosion hazard		Water contamination	Toxicological data		
		Ignition temperature	Explosion limit		Irritant	Danger to health	Toxic
< 200 °C	No	355 °C	0.6 to 8 % v/v	Yes	Yes	See note	No
≥ 200 °C ≤ 350 °C	No	490 °C	-	Yes	Yes	See note	No
> 350 °C ≤ 500 °C	No	No	No	No	No	No	No

At present, there is no restrictive statement from the health authorities concerning any danger to health over short periods and at low concentration, e.g. after a fracture of the measuring system.

# 3 Identifying the device version

## 3.1 Nameplate

Exemplary marking on the device housing:

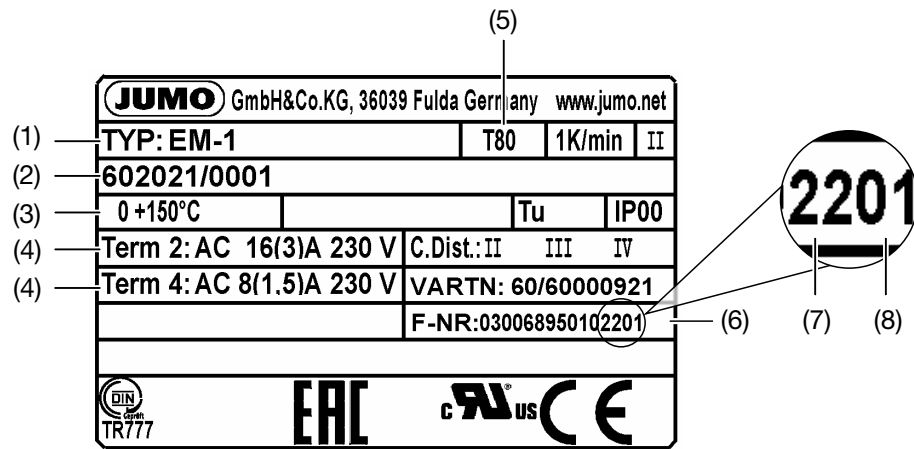

- (1) Type
- (2) Order code
- (3) Regulating or limit value range/ambient temperature at which this thermostat was calibrated (option)
- (4) Switching capacity
- (5) Permissible ambient temperature
- (6) Fabrication number
- (7) Year of manufacture
- (8) Week of manufacture



## 3 Identifying the device version

### 3.2 Order details

	<b>(1) Basic type</b>	
602021	Panel-mounted thermostats, EM Series	
	<b>(2) Basic type extensions</b>	
0001	EM-1	Temperature controller (TR), 1-pole
0002	EM-2	Temperature monitor (TW), 1-pole
0003	EM-3	Temperature monitor (TW), permanently set, 1-pole
0004	EM-4	Temperature limiter (TB), permanently set, 1-pole
0005	EM-5	Temperature limiter (TB), 1-pole
0013	EM-13	Temperature controller (TR/TW), 2-pole
0014	EM-14	Temperature controller (TR/TB), 2-pole
0020	EM-20	Safety temperature monitor (STW (STB))
0023	EM-23	Temperature monitor (TW/TW), permanently set
0024	EM-24	Temperature monitor (TW/TB), 2-pole
0030	EM-30	Safety temperature monitor (STW (STB)), permanently set
0033	EM-33	Temperature monitor (TW/TW), 2-pole
0040	EM-40	Safety temperature limiter (STB), permanently set
0044	EM-44	Temperature limiter (TB/TB), 2-pole
0050	EM-50	Safety temperature limiter (STB)
0054	EM-54	Temperature limiter (TB/TB), 2-pole
0133	EM-133	Temperature controller (TR/TW/TW), 3-pole
0134	EM-134	Temperature controller (TR/TW/TB), 3-pole
0233	EM-233	Temperature monitor (TW/TW/TW), 3-pole
0333	EM-333	Temperature monitor (TW/TW/TW), 3-pole
0444	EM-444	Temperature limiter (TB/TB/TB), 3-pole
0544	EM-544	Temperature limiter (TB/TB/TB), 3-pole
1333	EM-1333	Temperature controller (TR/TW/TW/TW), 4-pole
2333	EM-2333	Temperature monitor (TW/TW/TW/TW), 4-pole
3333	EM-3333	Temperature monitor (TW/TW/TW/TW), 4-pole
	<b>(3) Control range (TW)</b>	
000	For permanently set limit value	
013	-20 to +40 °C	
021	0 to 50 °C	
025	0 to 100 °C	
027	0 to 150 °C	
028	0 to 200 °C	
041	20 to 90 °C	
045	20 to 400 °C	
046	20 to 500 °C	
052	30 to 110 °C	
062	50 to 200 °C	
063	50 to 250 °C	
064	50 to 300 °C	
075	75 to 100 °C	
085	85 to 110 °C	

### 3 Identifying the device version

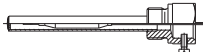
090	120 to 150 °C	
091	160 to 200 °C	
092	210 to 300 °C	
094	250 to 300 °C	
095	300 to 400 °C	
096	350 to 500 °C	
	<b>(4) Limit value (STW/STB)</b>	
000	For adjustable control range	
100	100 °C	
95	95 °C	
	<b>(5) Switching differential</b>	
00	None	
	With liquid-filled measuring system	
10	1 %	Only with TR and TW
25	2.5 %	Only with TR and TW
50	5 %	Only with TR, TW and STW
70	7 %	Only with TR, TW and STW
	With gas-filled measuring system	
30	3 %	Only with TR and TW
50	5 %	Only with TR, TW and STW
60	6 %	Only with TR and TW
01	10 %	Only with TR and TW
	<b>(6) Capillary length</b>	
0	None	
1000	1,000 mm	
2000	2,000 mm	
3000	3,000 mm	
4000	4,000 mm	
5000	5,000 mm	
	<b>(7) Capillary material</b>	
20	CrNi (stainless steel)	
40	Cu (copper)	
	<b>(8) Process connection</b>	
10	Plain cylindrical probe	
20	Screw-in protection tube	
	<b>(9) Thread of process connection</b>	
00	None	
13	G 1/2	
	<b>(10) Process connection material</b>	
00	None	
20	CrNi (stainless steel)	
46	CuZn (brass)	
	<b>(11) Insertion length</b>	
000	None	
100	100 mm	



# 4 Mounting

## 4.1 Dimensions

EM-1, EM-2, EM-3, EM-4, EM-5

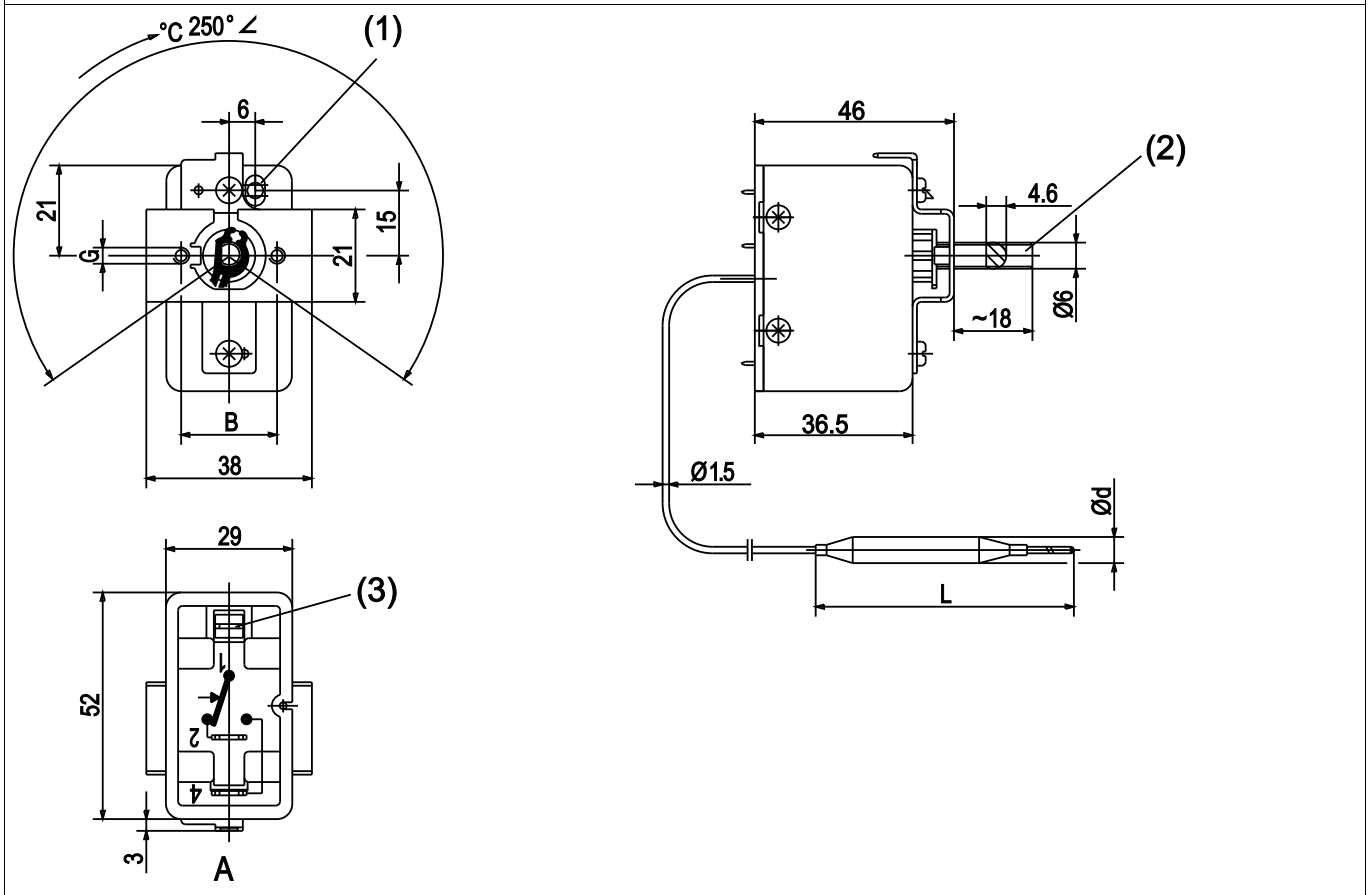

- (1) Restart knob only with abbreviation 4 and 5
- (2) Not applicable with abbreviation 2, 3, 4, 5
- (3) Tab connector DIN 46244-A6,3-0,8
- (A) Rear view

EM-13, EM-14, EM-20, EM-23, EM-24, EM-30, EM-33, EM-40, EM-44, EM-50, EM-54

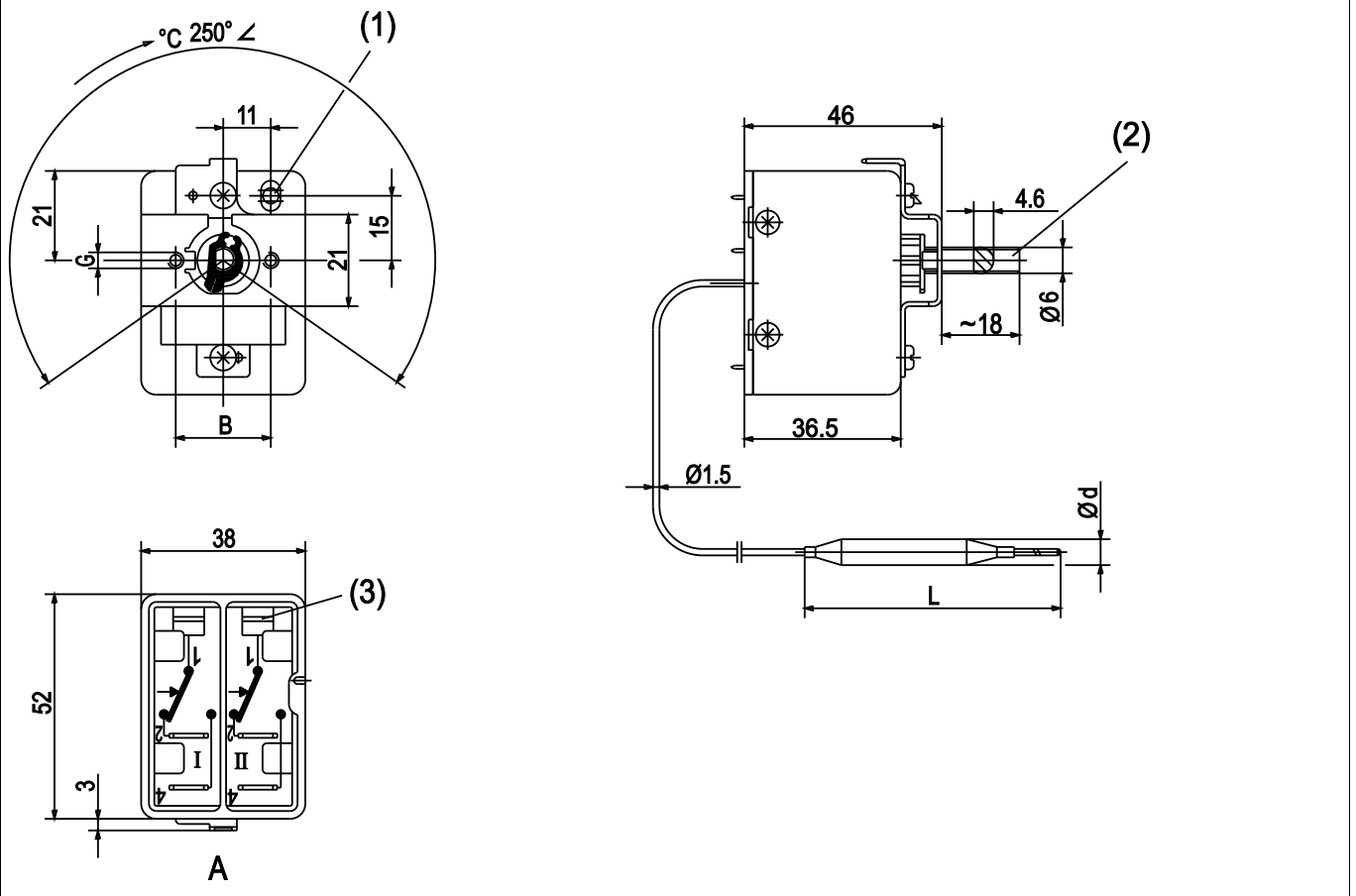

- (1) Restart knob only with abbreviation 40, 44, 50 and 5
- (2) Not applicable with abbreviation 2, 3, 4, 5, 20, 30, 40 and 50
- (3) Tab connector DIN 46244-A6,3-0,8
- (A) Rear view

## 4 Mounting

EM-133, EM-134, EM-233, EM-234, EM-333, EM-444, EM-544

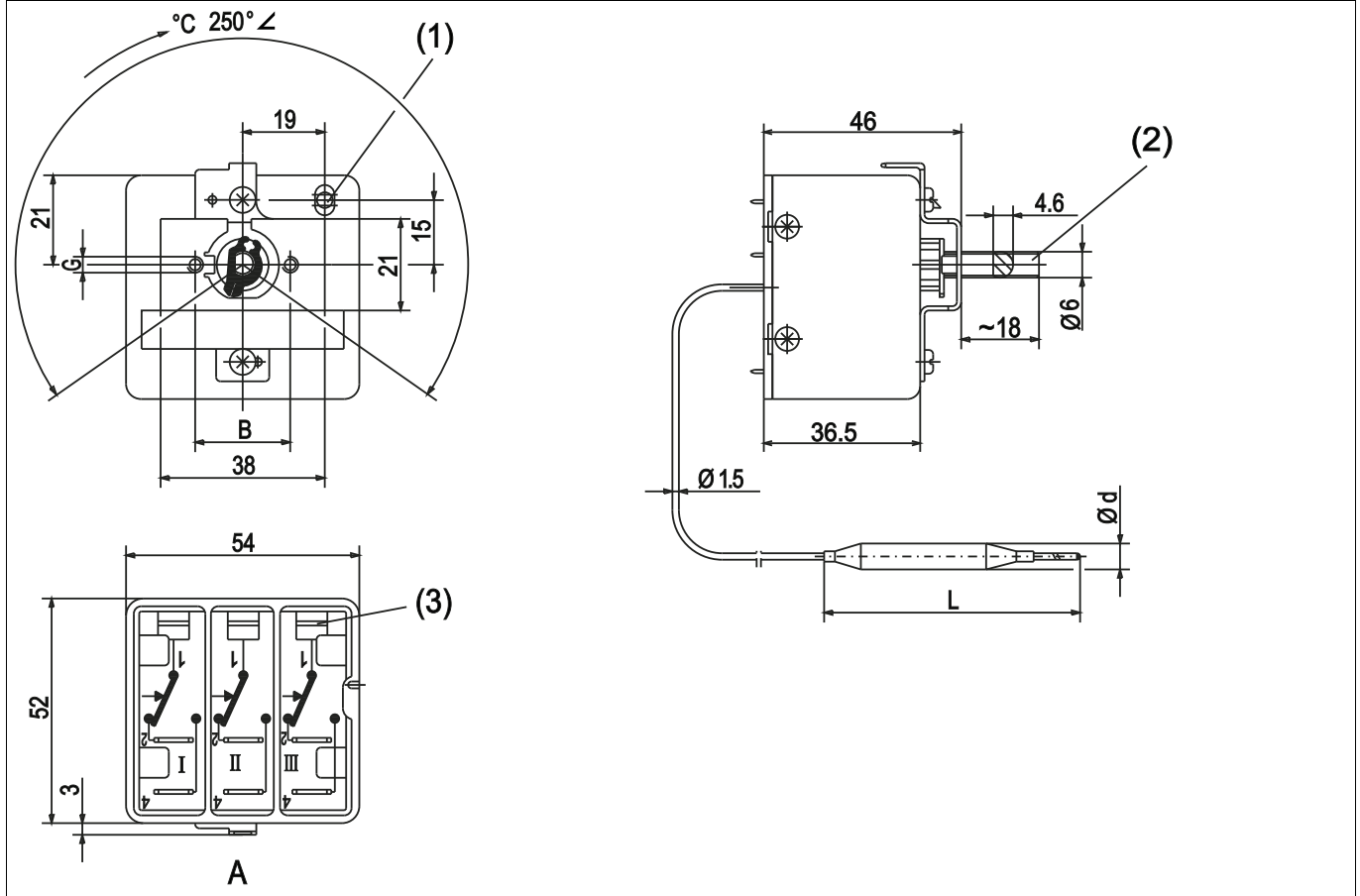

- (1) Restart knob only with abbreviation 444, 544
- (2) Not applicable with abbreviation 2, 3, 4, 5
- (3) Tab connector DIN 46244-A6,3-0,8
- (A) Rear view

## EM-1333, EM-2333, EM-3333

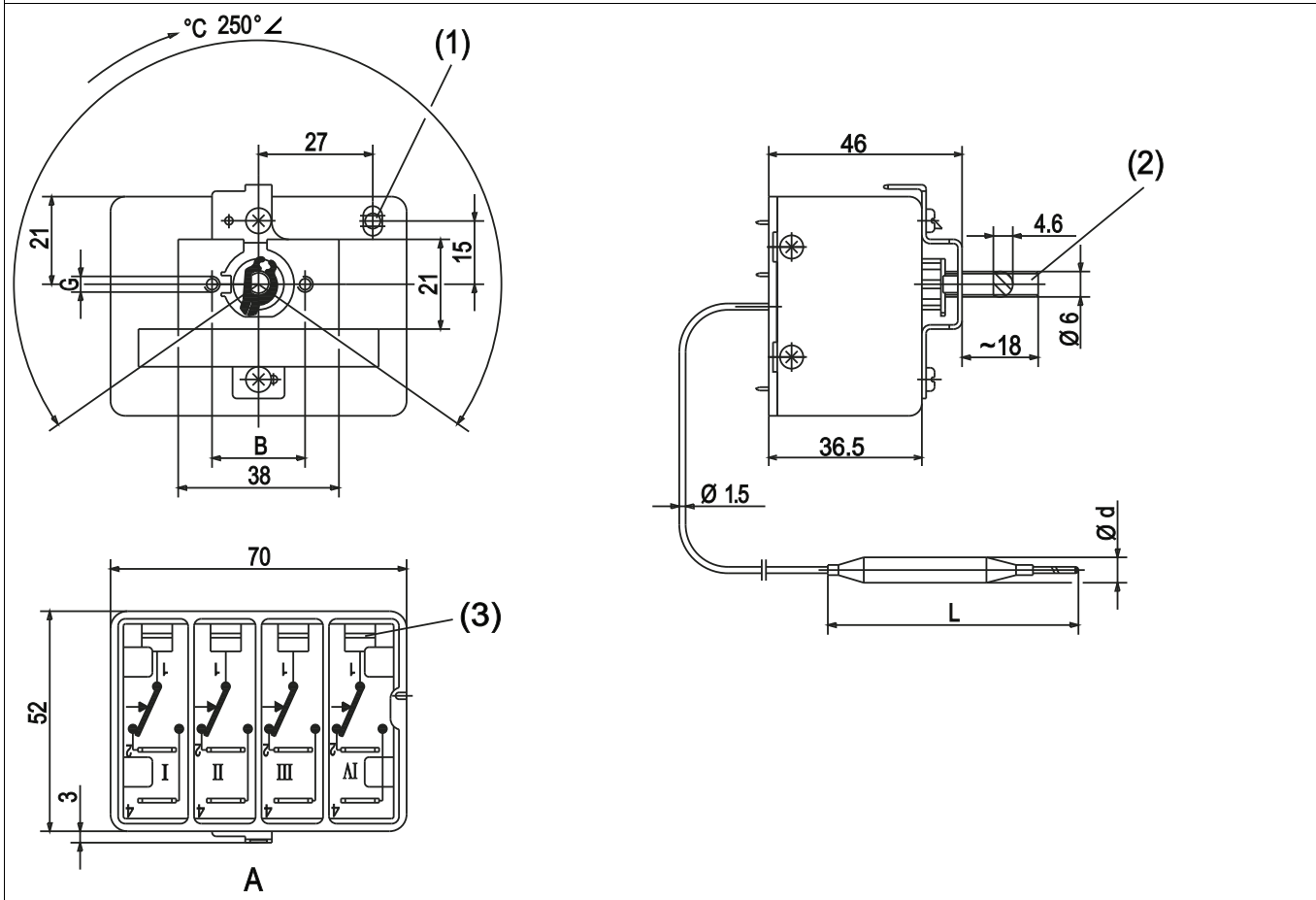

- (1) Restart knob only with abbreviation 4444
- (2) Not applicable with abbreviation 2, 3, 4, 5
- (3) Tab connector DIN 46244-A6,3-0,8
- (A) Rear view

	B	G
Standard	22	M3
Extra code 704	28	M4
Extra code 705	33	M3

## Screw connection EM-1, extra code 699

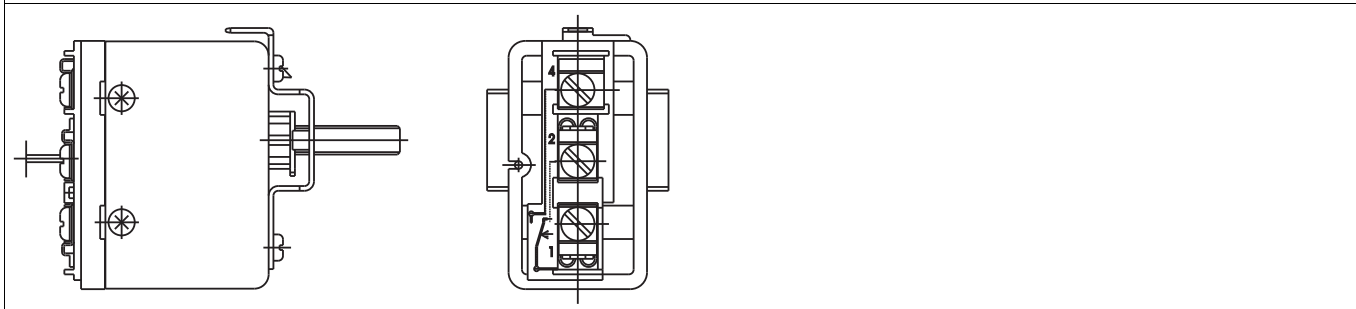

# 4 Mounting

## 4.2 Fixing the panel-mounted thermostat

Operating position	Any
--------------------	-----

### 4.2.1 Mounting the switching head

#### EM-1

Mounting the switching head with 2 screws M3 on chassis (M4 with extra code 704).

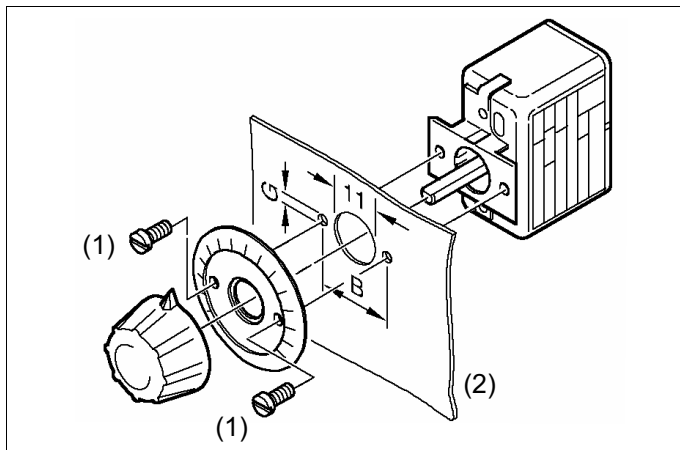

- (1) Screw
- (2) Panel

	Dim. (mm)	
	G	B
Standard	3,5	22
Extra code 704	4,5	28
Extra code 705	3,5	33

#### EM-2, EM-3, EM-4, EM-5, EM-20, EM-30, EM-30, EM-40, EM-44, EM-50, EM-54, EM-444, EM-544

Mounting the switching head with 2 screws M3 on chassis (M4 with extra code 704).

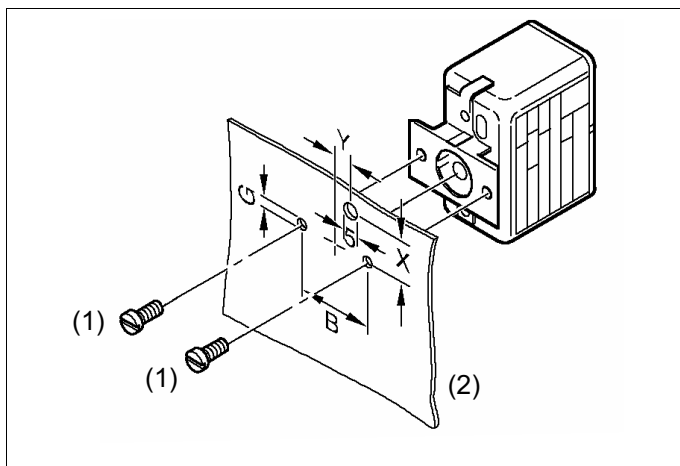

- (1) Screw
- (2) Panel

	Dim. (mm)	
	X	Y
EM-2, EM-3, EM-20, EM-30	-	-
EM-4, EM-5	15	6
EM-40, EM-50	15	11
EM-44, EM-54	15	11
EM-444, EM-544	15	19

	G	B
	Standard	3,5
Extra code 704	4,5	28
Extra code 705	3,5	33



## EM-4, EM-5, EM-40, EM-50 with central mounting

Extra code 710

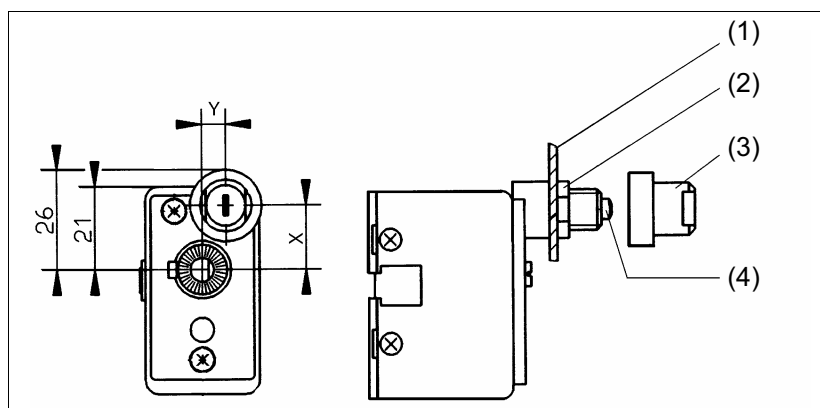

	Dim. (mm)	
	X	Y
EM-4, EM-5	16	6
EM-40, EM-50	16	11

- (1) Panel
- (2) Fixing nut M10 × 1 (13 a/f)
- (3) Acorn nut M10 × 1 (10 a/f)
- (4) Restart knob

## 4.3 Capillary, temperature probe and thermowell

### 4.3.1 General information

#### **NOTICE!**

#### **Failure of the device due to defective capillary**

Cutting or kinking of the capillary leads to permanent failure of the functions.  
The minimum permissible bending radius of the capillary is 5 mm.

The temperature probe must be completely immersed in the medium to be measured. The temperature probe or protection tube must **not** come into contact with the walls of the container or pipe.

To ensure their overall accuracy, the thermostats must only be used together with the pockets supplied by the factory (diameter D = 8 or 10 mm).

Thermowells with diameter D = 10 mm may only be fitted with probes with diameter d = 8 mm.

Fitting several probes into a common thermowell is permissible with 2 or 3 cylindrical probes with diameter D = 6 mm and thermowells 15 × 0.75 mm. When fitting 2 probes in a common thermowell, the default-supplied pressure spring must be fitted in the thermowell.

For operation in air, process connection 10 (without thermowell) must be chosen.

In the case of thermowells 22, 41, 42, and 45, in materials St.35.8 I, the permissible operating life at operating temperatures above 420 °C is limited to 200,000 hours. The requirements of TRD 508 must be observed for operation in this range.

## 4 Mounting

---

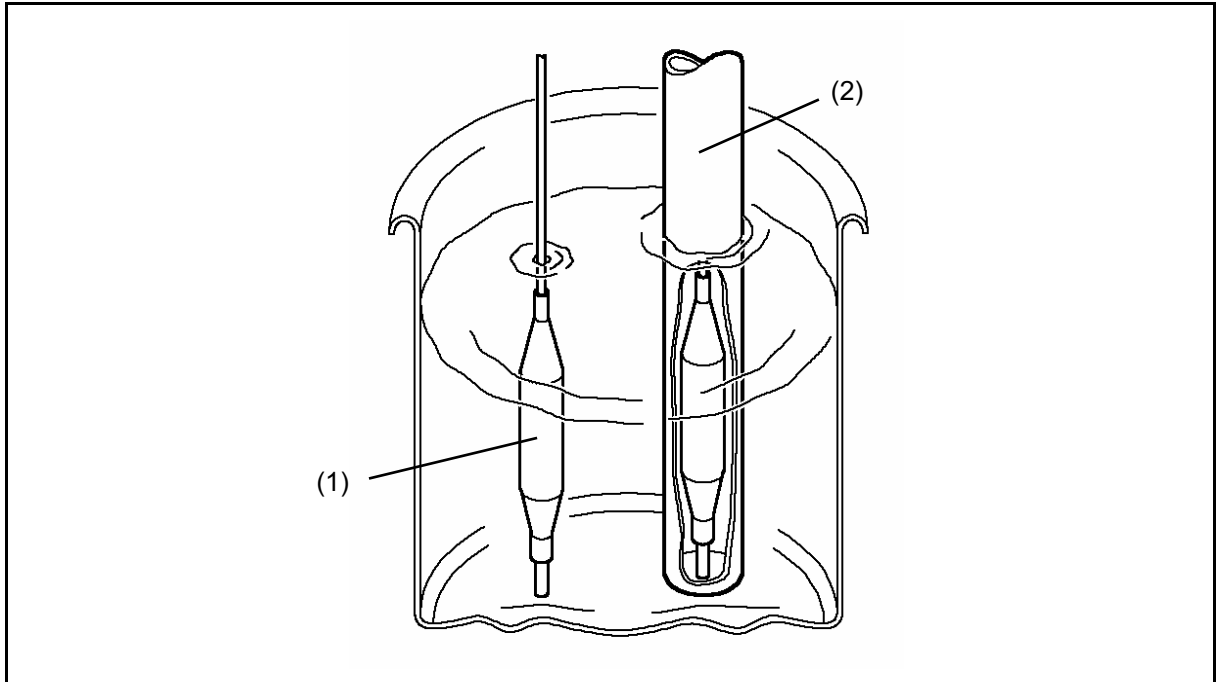

- (1) Immersion tube
- (2) Temperature probe

### 4.3.2 Approved process connections

For detailed information, refer to data sheet 606710.

## 4.4 Permissible pressure at the thermowell

### 4.4.1 Thermowells 20, 22/23, 40, and 41/42

The values given below refer to the maximum loading on the probe mounting concerned. The maximum pressure which can be sealed depends on the mounting conditions and may possibly be lower.

#### Steel thermowells 22, 23, 32, 41, 42 and 45

Material	
Pipe	St38.8 I
Screw-in nipple up to 300 °C	Steel 1.0038
Weld-in nipple	Steel 1.5415

Temperature in °C	Pipe diameter 8 × 0.75 mm or conical	Pipe diameter 10 × 0.75 mm	Pipe diameter 15 × 0.75 mm
	Maximum permissible pressure in bar		
100	89	72	48
150	83	67	45
200	78	63	42
300	59	47	32
350	50	40	27

**Permissible incident flow velocity [m/s] at the maximum permissible pressure loading and different immersion tube length "S"**

Material	St38.8 I
Temperature	200 °C
Heat transfer	Air, water, oil
Pipe diameter D	8 mm      _____ 10 mm      - - - - - 15 mm      ·········

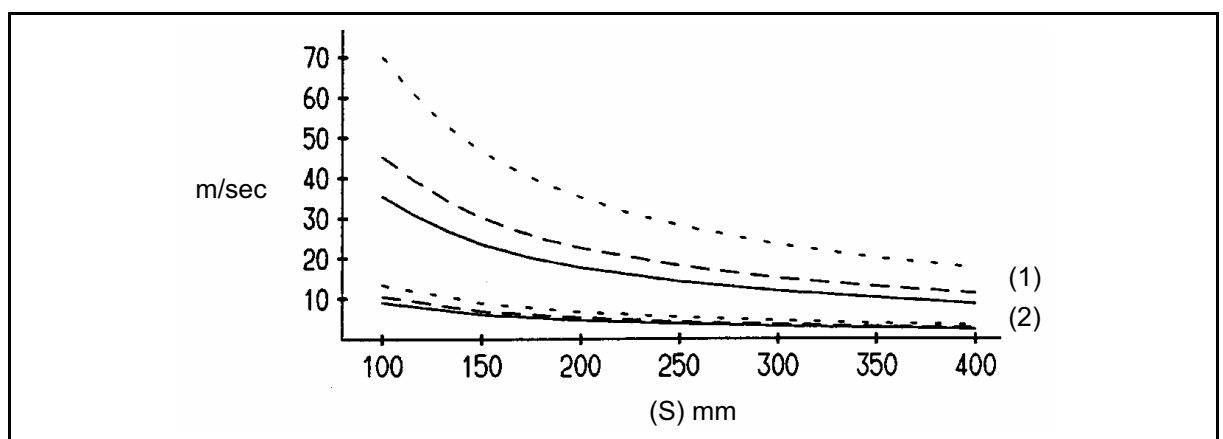

- (1) Air
- (2) Water, oil

# 4 Mounting

Permissible incident flow velocities [m/s] at maximum permissible pressure load and different immersion tube temperature "t"

Material	St38.8 I
Immersion tube length S	200 mm
Heat transfer	Air, water, oil
Pipe Diameter	8 mm      _____ 10 mm     - - - - - 15 mm     ·········

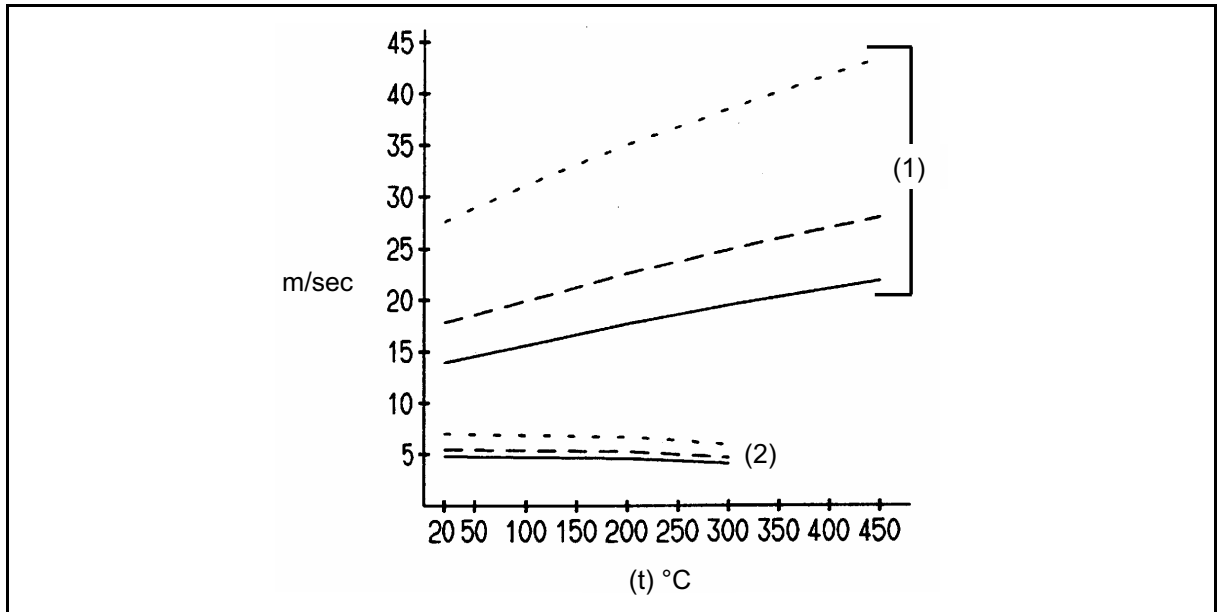

- (1) Air
- (2) Water, oil

## Stainless steel thermowells 20, 22, 40 and 41/42

Material Pipe and nipple	Stainless steel (1.4571)		
Temperature in °C	Pipe diameter 8 × 0.75 mm or conical	Pipe diameter 10 × 0.75 mm	Pipe diameter 15 × 0.75 mm
	Maximum permissible pressure in bar		
100	92	74	50
150	88	71	48
200	83	67	45
300	72	58	39
400	67	54	36

## 4 Mounting

### Brass thermowells 20 and 40

Material Pipe and nipple	CuZn		
Temperature in °C	Pipe diameter 8 × 0.75 mm	Pipe diameter 10 × 0.75 mm	Pipe diameter 15 × 0.75 mm
	Maximum permissible pressure in bar		
100	50	40	27
150	48	39	26

### Probe connections 50, 52 and 54

Material Pipe	CuZn	Steel (1.0038)	Stainless steel (1.4571)
Temperature	200	300	400
Probe material	Ø mm	Switching function	
		TR, TW, TB bar	STB, STW (STB) bar
Cu-DHP	4	6	2
	5	5	2
	6	4	2
	7	3	2
	8	3	2
	9	3	2
	10	3	2
St35 (1.4571)	4 to 10	10	2



#### WARNING!

Types 10, 15, 21, 60 and 65 may only be used in unpressurized media.

## 4 Mounting

---

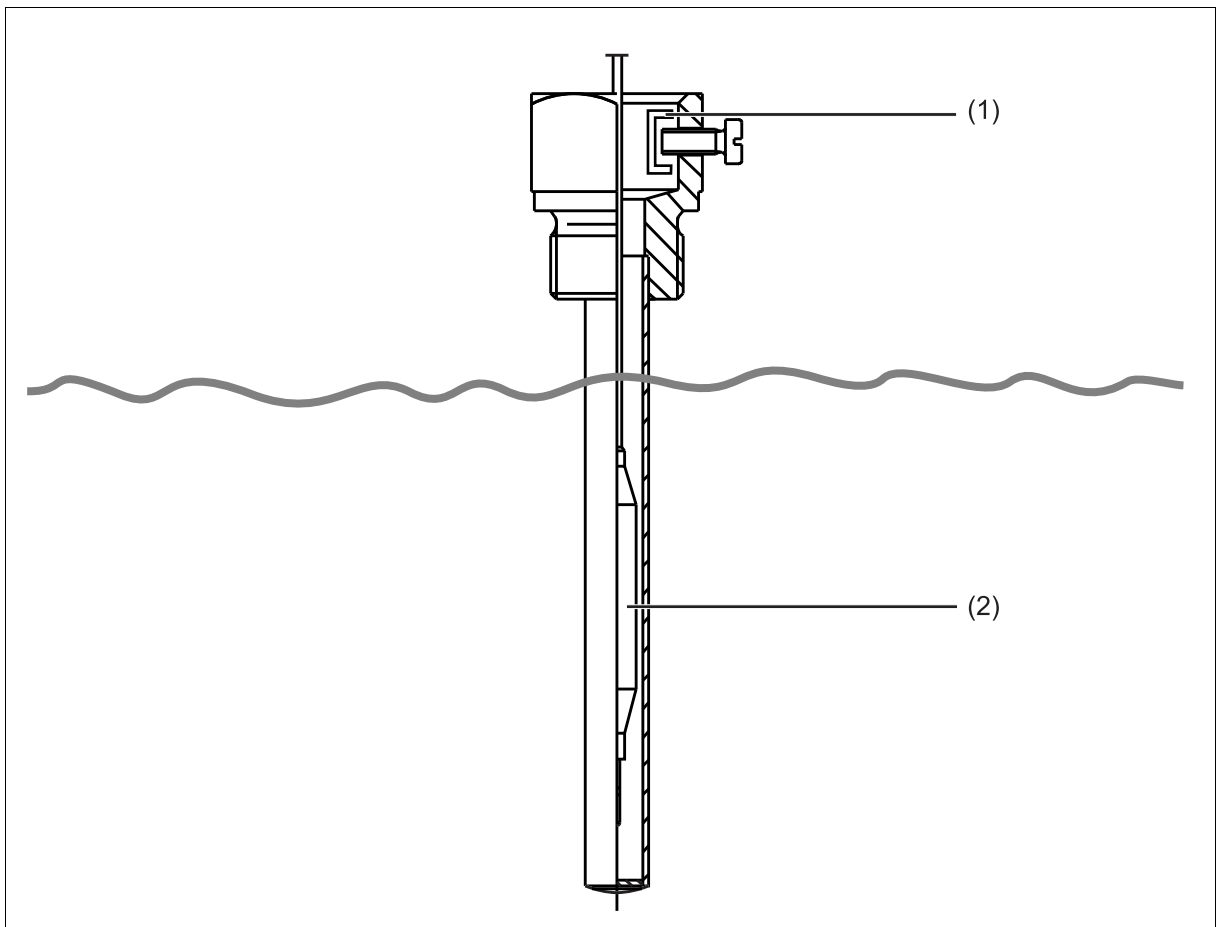

- (1) Clamping piece
- (2) Temperature probe

The temperature probe must be immersed in the medium for its entire length, otherwise there will be appreciable deviations from the switching point.

For connection types 20, 21 and 22/23, the temperature probe is fixed in the protective sleeve with the clamping piece.

If you determine an external defect, also at mechanical way, the differential pressure transmitter has to be sent for repair to the manufacturer.

## 5.1 Installation notes



### CAUTION!

**The electrical connection must only be made by qualified personnel.**

The choice of cable, the installation and the electrical connection must conform to the requirements of VDE 0100 „Regulations for the installation of power circuits with nominal voltages below 1000 V“, or the appropriate local regulations..

If contact with live parts is possible while working on the unit, it must be completely disconnected from the supply.

Earth the instrument at the PE terminal to the protective conductor. This cable must have a cross-section that is at least as large as the supply cables. Earth cables must be run in a star configuration to a common earth point which is connected to the protective earth of the supply. Do not loop earth cables, i.e. do not run them from one instrument to another.

Apart from faulty installation, incorrect settings on the thermostat can affect the proper functioning of the following process or lead to damage. Setting up must therefore be restricted to qualified personnel. Please observe the appropriate safety regulations in this respect.

## 5.2 Electrical connection

- Terminals and connections are suitable for internal conductors
- Connection joints are suitable for permanently installed lines
- Cable supply takes place without strain relief
- Device complies with protection class I



### WARNING!

**Capillary tube without protection conductor function**

The user must provide the required protection against electric shock for the probe and the capillary tube.

### Plug connection

Standard

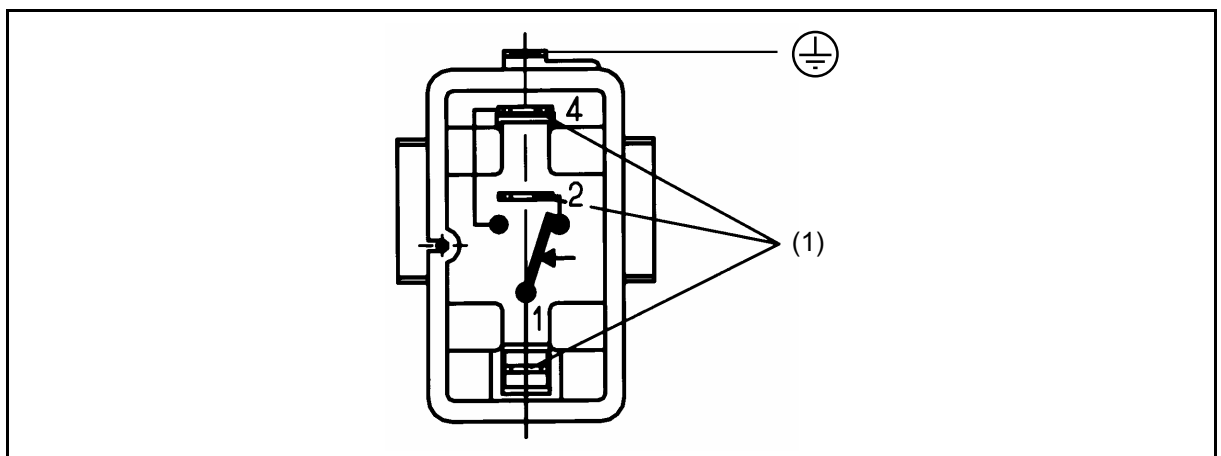

(1) Tab connector DIN 46244-A, 6,3 × 0,8

# 5 Installation

## Screw connection

Extra code 699

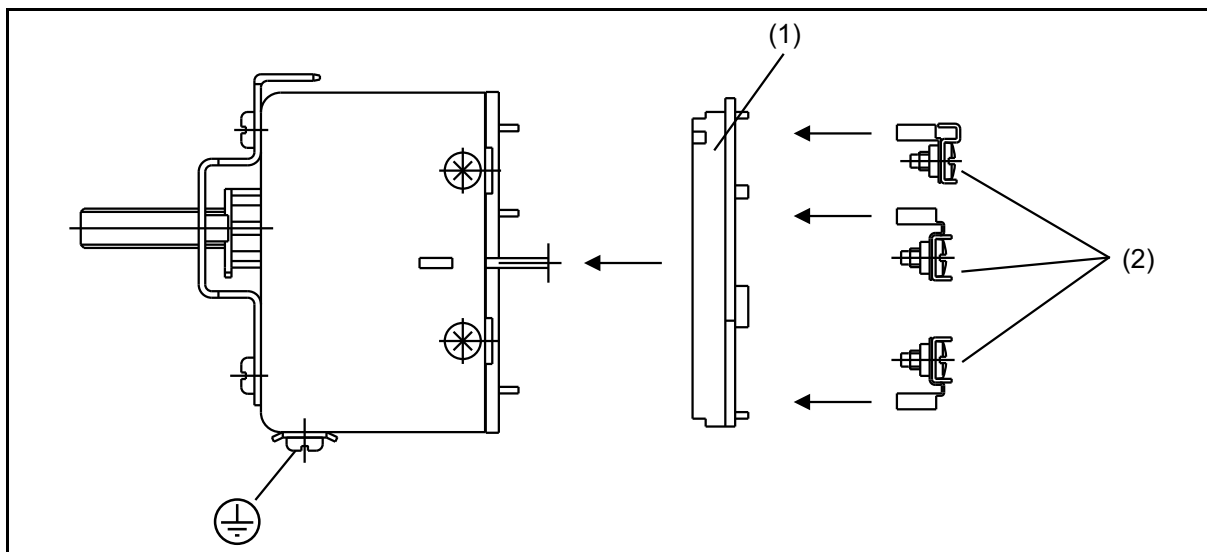

- (1) Plug-in sleeve 6.3 with connection screw, suitable for conductor cross-sections up to 2.5 mm<sup>2</sup>, attachment type X, no special tools
- (2) Terminal strip



## 5.3 Connection diagram

EM-1, EM-2, EM-3

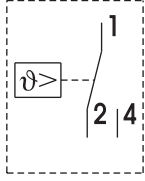

EM-4, EM-5

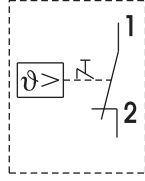

EM-13, EM-23, EM-33

Setpoint: I  
Sequence contact: II

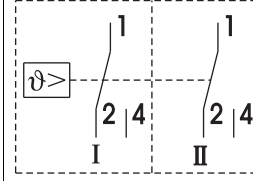

EM-4/574, EM-5/574

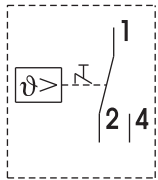

EM-133, EM-233, EM-333

Setpoint: I  
Sequence contact: II, III

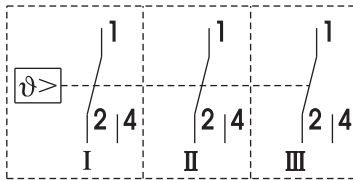

EM-40, EM-50

n.c. (break) contact  
on measuring system failure  
and  $T < -10\text{ }^{\circ}\text{C}$ : I  
Limit value: II

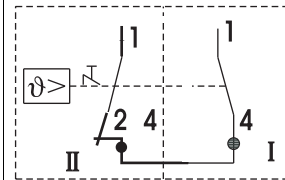

EM-1333, EM-2333, EM-3333

Setpoint: I  
Sequence contact: II, III, IV

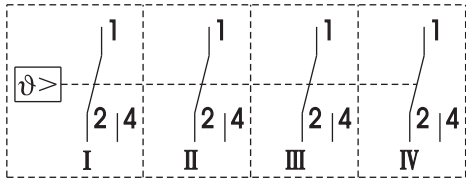

EM-40/574, EM-50/574

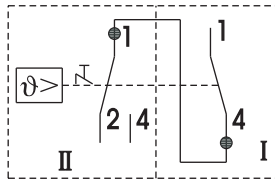

EM-20, EM-30

n.c. (break) contact  
on measuring system failure  
and  $T < -10\text{ }^{\circ}\text{C}$ : I  
Limit value: II

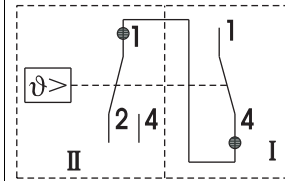

# 6 Settings

---

## 6.1 Unlocking the TB or STB

**EM-4, EM-40, EM-44, EM-444, EM-5, EM-50, EM-54, EM-544 with switching head mounting**

Extra code 704, 705

After the temperature has dropped by about 10 % of span below the set limit(critical temperature), the microswitch can be reset.

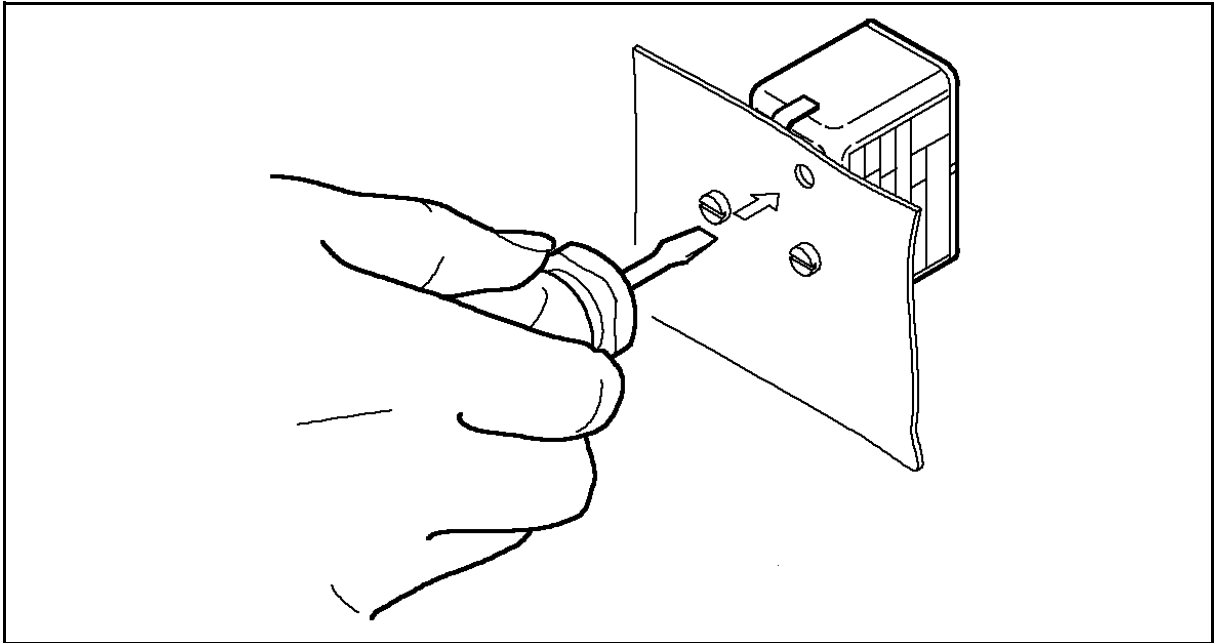

1. Push the reset button using a small screwdriver.

**EM-4, EM-40, EM-44, EM-444, EM-5, EM-50, EM-54, EM-544 with central mounting**

Extra code 710

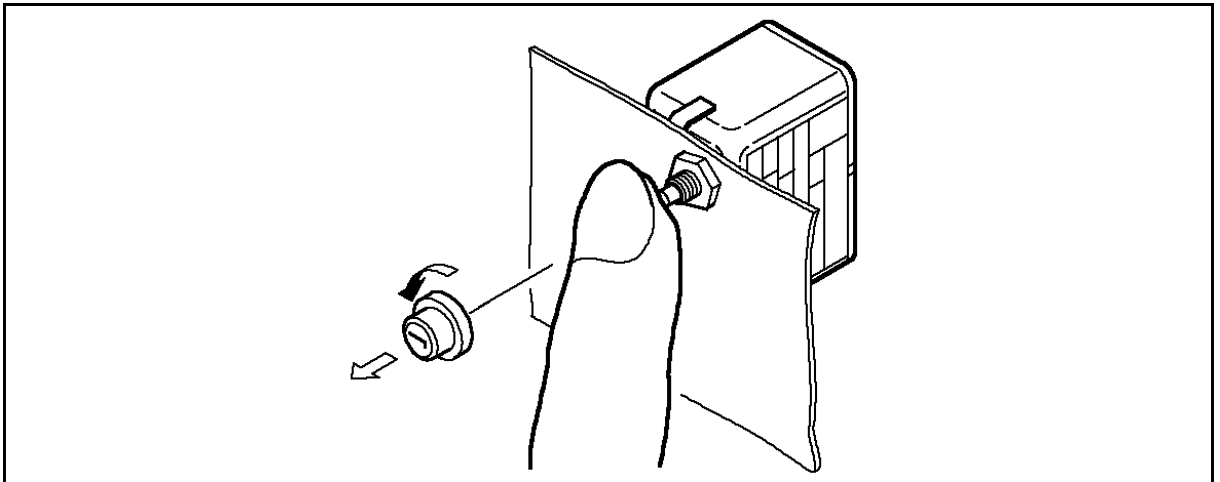

1. Unscrew cap.
2. Press reset button.
3. Screw cap back into position.

## 6.2 Setpoint adjustment

### EM-1, EM-13, EM-133, EM-1333

1. Rotate the setpoint knob by hand over the external scale.

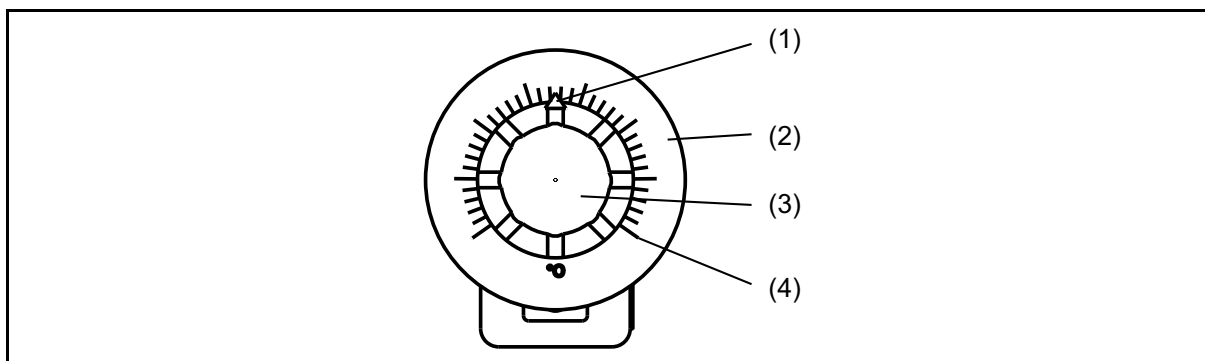

- (1) Setpoint marker
- (2) External scale
- (3) Setpoint knob
- (4) Scale graduation

### EM-2, EM-20, EM-23, EM-233, EM-2333, EM-5, EM-50, EM-54, EM-544

1. Rotate the setpoint spindle over the internal scale using a screwdriver.

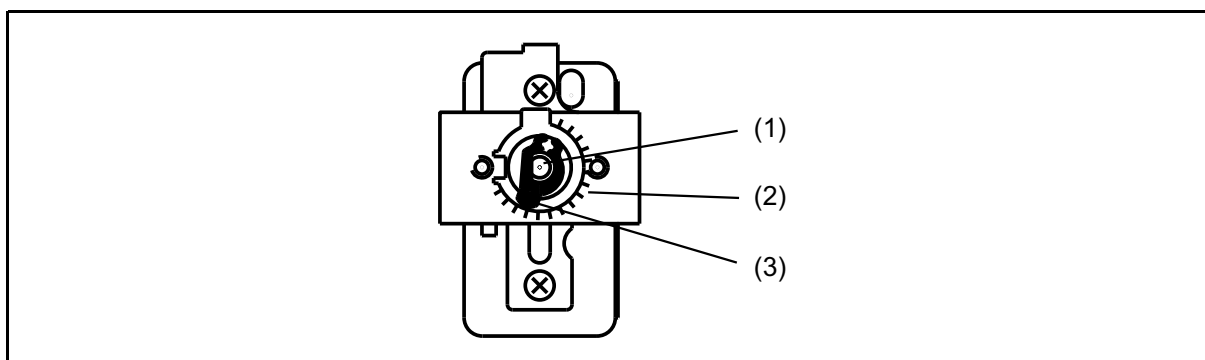

- (1) Setpoint spindle
- (3) Scale graduation
- (4) Setpoint marker

### EM-3, EM-30, EM-33, EM-333, EM-3333, EM-4, EM-40, EM-44, EM-444

The limit value setting is fixed at the factory and sealed. It must subsequently **not** be adjusted.

## 7 Technical data

### 7.1 Control ranges and probe table

For TR, TW, TB – liquid-filled

Control range/limit value range °C	Switching differential %	Max. probe temperature °C	Max. switching head temperature °C	Max. capillary length in mm	Max. sequence contact gap K	Probe length "L", probe Ø "d" in mm	
						Ø 6 (Standard)	Ø 8
-20 to +40	1	50	50	5000	5	245	145
	2.5	50			8	245	145
	5	95			25	138	91
	7	100			50	103	73
0 to 50	1	60	60		5	283	165
	2.5	60			10	283	165
	5	105			25	159	101
	7	110			50	117	80
20 to 90	1	115	80		7	210	127
	2.5	115			14	210	127
	5	140			35	121	82
	7	175			70	91	67
0 to 100	1	125	80		10	157	100
	2.5	125			20	157	100
	5	165		50	94	68	
	7	200		100	73	58	
30 to 110	1	135	80	8	188	116	
	2.5	135		16	188	116	
	5	170		40	110	76	
	7	200		80	84	63	
0 to 150	1	173	80	15	113	78	
	2.5	173		30	113	78	
	5	200		75	72	57	
0 to 200	1	230	80	20	113	78	
	2.5	230		40			
50 to 200	1	230	80	15	139	92	
	2.5	230		30			
50 to 250	1	288	80	20	105	70	
	2.5	288		40	105	70	
	5	300		100	64	49	
50 to 300	1	345	80	25	87	61	
	2.5	345		50			

For TR, TW, TB – gas-filled

Control range/limit value range °C	Switching differential %	Max. probe temperature °C	Max. switching head temperature °C	Max. capillary length in mm	Max. sequence contact gap K	Probe length "L", probe Ø "d" in mm	
						Ø 6 (Standard)	Ø 8
20 to 400	5	460	80	5000	75	237	137
	10	500			200	127	81
20 to 500	3/5	575	80		1000	48	278
	6			5000	95	276	106
	10			5000	250	95	65

## 7.2 Control ranges and temperature probes

For STB and STW (STB) – liquid-filled

Setting range °C	Scale range °Z	Max. probe temperature °C	Max. switching head temperature °C	Max. capillary length in mm	Limit value tolerance K	Probe length "L", probe Ø "d" in mm	
						Ø 6 (Standard)	Ø 8
75 to 100	78	125	80	5000	+0	84	63
85 to 110	78	135			-7		
120 to 150	77	173			+0	80	57
					-9		
160 to 200	79	230			+0	64	49
					-12		
210 to 250	71	288	+0	61	47		
			-13				
250 to 300	79	345	+0	55	-		
			-16				

For STB and STW (STB) – gas-filled

Setting range °C	Scale range °Z	Max. probe temperature °C	Max. switching head temperature °C	Max. capillary length in mm	Limit value tolerance K	Probe length "L", probe Ø "d" in mm	
						Ø 6 (Standard)	Ø 8
300 to 400	70	460	80	3000	+0	148	92
					-23		
350 to 500	72	575			+0	127	81
					-29		

When the switching points are permanently factory-set, the deactivation value must be specified in addition to the control range (e.g. control range 80 to 100 °C, permanently set to 95 °C).

## 7.3 Capillary and temperature probe

Type	Scale limit value	Capillary	Probe
EM-...	Up to 200 °C	Copper (Cu) Ø 1.5 mm Material no. Cu-DHP	Copper (Cu) Material no. Cu-DHP Hard soldered
	Up to 350 °C	Copper (Cu) Ø 1.5 mm Material no. Cu-DHP	Stainless steel (CrNi) Material no. 1.4571 Hard soldered
	Up to 500 °C	Stainless steel (CrNi) Ø 1.5 mm	Stainless steel (CrNi) Material no. 1.4571 Welded
	Up to 350 °C	Stainless steel (CrNi) Ø 1.5 mm	Stainless steel (CrNi) Material no. 1.4571 Welded (available at extra cost)
Capillary length	Standard 1,000 mm, max. 5,000 mm		
Min. bending radius of capillary	5 mm		

## 7 Technical data

**NOTE:**

Upon request the capillary length can be increased up to a maximum of 5,000 mm if the allowable temperature on the sensor, capillary, and switching head is not reached.

Please let us know the actual temperature values to which the thermostat is exposed.

### 7.4 Electrical data

Switching element 1, 2, 3, or 4 single-pole snap-action switches	EM-1, EM-2, EM-3, EM-20, EM-30	EM-4, EM-5, EM-40, EM-50	EM-4.../U, EM-5.../U, EM-40/U, EM-50/U
	Microswitch with changeover contact	Microswitch with N/C contact and re- start lock	Microswitch with N/C contact, restart lock, and additional sig- nal contact
Maximum switching capacity	Switching function Switching differential	N/C contact, terminal 2	N/O contact, terminal 4
	TR, TW, STB (STB) 2.5 %, 5 %, 6 %, 7 %, 10 %	AC 230 V +10 % 16 (3) A, $\cos \varphi = 1$ (0.6) DC 230 V +10 %, 0.25 A	AC 230 V +10 % 8 (1.5) A, $\cos \varphi = 1$ (0.6) DC 230 V +10 %, 0.25 A
	TB, STB	AC 230 V +10 % 16 (3) A, $\cos \varphi = 1$ (0.6) DC 230 V +10 %, 0.25 A	AC 230 V +10 % 2 (1) A, $\cos \varphi = 1$ (0.6) DC 230 V +10 %, 0.25 A
	TR, TW 1 %, 3 %	AC 230 V +10 %, 6 (2) A, $\cos \varphi = 1$ (0.6), DC 230 V +10 %, 0.25 A	
	TR, TW 2.5 %	Microswitch with gold plating, extra code 702, AC/DC 24 V, 0.1 A	
Contact reliability	To ensure the greatest possible switching reliability we recommend a minimum load of: For silver contacts: AC/DC 24 V, 100 mA For gold-plated contacts (extra code 702): AC/DC = 10 V, 5 mA		
Rating surge voltage	2500 V (via the switching contacts 400 V)		
Overvoltage category	II		
Required fuse rating	See maximum switching capacity		
Electrical connection	Standard: Tab connector A 6.3 × 0.8 DIN 46244 Extra code 699: Screw connection up to 2.5 mm <sup>2</sup> conductor cross section (available at extra cost), also suitable for retrofitting		

## 7.5 Operating data

Switching differential in % of control range/limit value range	Measuring system				
	Liquid-filled		Gas-filled		
	Nominal value	Possible actual value	Nominal value	Possible actual value	
Switching function TR, TW	2.5	Approx. 2.5 to 3.5	5	Approx. 5 to 11	Standard
	5	Approx. 5 to 6	6	Approx. 6 to 14	Upon request
	7	Approx. 7 to 8	10	Approx. 10 to 16	Upon request
	1	Approx. 1 to 2	3	Approx. 2.5 to 4	Extra cost
STW (STB)	5	Approx. 5 to 7	6	Approx. 6 to 16	Standard

Sequence contact gap on multi-pole versions	Switching differential	Sequence contact gap relative to scale range		Switching point accuracy of the sequence contact gaps from the scale range
		Minimum	Maximum	
	1 %	1 %	According to control range table	≤ 1 %
2.5 %	1 %	≤ 1 %		
3 %, 5 %	2 %	≤ 1 %		
6 %, 7 %, 10 %	3 %	≤ 1 %		
The sequence contact gap can be specified in °C in relation to the setpoint of contact I. (The contact track no. is stamped on the back of the housing par.) Prefix - = switching <b>before</b> reaching the setpoint value Prefix + = switching <b>after</b> reaching the setupoint value For the synchroized version, specify "0" as the sequence contact gap.				

Switching point accuracy in % of control range/limit value range	Switching differential		In the upper third of the scale or limit value
	Liquid-filled	Gas-filled	
Switching function TR	1 %, 2.5 %	-	±1.5 %
	5 %	3 %, 5 %	±3 %
	7 %	6 %, 10 %	±4 %
TW	1 %, 2.5 %	-	±1.5 %
	5 %	3 %, 5 %	±3 %
	7 %	6 %, 10 %	±4 %
TB	-	-	+0 % -5 %
STW (STB)	See table for control ranges and probes		

## 7 Technical data

Mid ambient temperature influence	Deviation of the ambient temperature at the switching head and/or capillary from the 22 °C calibration ambient temperature produces a switching point off-set. Higher ambient temperature = low switching point Lower ambient temperature = higher switching point											
For temperatures with scale limit value/limit value Switching differential in % Ambient temperature influence on the switching head in %/°C Ambient temperature influence on the capillary in %/m	TR, TW, TB				STW, STB		TR, TW, TB		STW, STB		TR, TW, TB, STW, STB	
	< 200 °C				≥ 200 °C ≤ 350 °C				≥ 400 °C ≤ 500 °C			
	1/2.5	5	7	7/-	1/2.5	5	7/-	3/5	6	10		
	0.15	0.26	0.34	0.43	0.12	0.21	0.35	0.12	0.17	0.24		
	0.05 · °C · m		0.09 · °C · m		0.09 · °C · m		0.07 · °C · m		0.05 · °C · m			
Temperature compensation (TK)	For detailed information see diagram.											
Temperatures Admissible storage temperature Admissible ambient temperature for use	-50 to +50 °C 80 °C max.											
Nominal position (NL)	Any											
Operating medium	Water, oil, air, superheated steam											
Time constant $t_{0.632}$ In water In oil In air or superheated steam	≤ 45 s ≤ 60 s ≤ 120 s											
Mode of operation TR, TW TB STW (STB) STB	According to EN 60730-1, DIN EN 60730-2-9, DIN EN 14597 2 BL 2 BFHLPV 2 BKLNP 2BFHKLNPV Declaration: 2 Mode of operation type 2 B Automatic mode of operation with micro disconnection F Only adjustable with tool H Release mechanism whose contacts can not be prevented from opening K With probe break protection L No auxiliary energy required P Mode of operation type 2, tested by declared temperature changes V Lockout											



### 7.6 Housing

Material	Galvanized sheet steel
Mounting Standard Extra code 704 Extra code 705 Extra code 710	With 2 M3 screws, spaced 22 mm Switching head mounting with 2 M4 screws, spaced 28 mm Switching head mounting with 2 M3 screws, spaced 33 mm Central mounting M10 × 1 with acorn nut (for TB and STB only)
Setpoint value setting TR TW, TB, STB, STW (STB) Types EM-3, EM-4, EM-30, EM-33, EM-40, EM-44, EMF-444, EMF-3333	Switching point adjustable from outside with rotary knob. Switching point adjustable with screwdriver. Permanently set at the factory to customer requirements.
Setpoint adjuster	See data sheet 606715
Scale range	Standard 250° ∠ (for STB and STW (STB)), see table for control ranges and probes
Protection type	IP00 according to EN 60529
Weight	Approx. 300 g



### 7.7 Process connection

Material Protection tube up to 150 °C Protection tube above 150 °C	CuZn (standard) CrNi
Capillary	Plain cylindrical probe (standard) <b>Screw-in protection tube</b> (upon request) Screw-in sleeve with screw-in spigot G 1/2", form A, according to DIN 3852/2 and clamping piece with fixing screw for securing the probe
Insertion length S Standard	100, 120, 150, 200 or 300 mm (other lengths upon request)
Protection tube Ø	D = 8 mm, D = 10 mm



For further process connections and protection tubes see data sheet 606710.

## 7 Technical data

### 7.8 Approvals

	Designation	DIN
	Testing agency	DIN CERTCO/TÜV Süd
	Certificates/certification numbers	TR777
	Inspection basis	DIN EN 14597
	Valid for	Type 602021/0001 (EM-1)
	Designation	DIN
	Testing agency	DIN CERTCO/TÜV Süd
	Certificates/certification numbers	TW778
	Inspection basis	DIN EN 14597
	Valid for	Type 602021/0002 (EM-2), Type 602021/0003 (EM-3)
	Designation	DIN
	Testing agency	DIN CERTCO/TÜV Süd
	Certificates/certification numbers	TB780
	Inspection basis	DIN EN 14597
	Valid for	Type 602021/0004 (EM-4), Type 602021/0005 (EM-5)
	Designation	DIN
	Testing agency	DIN CERTCO/TÜV Süd
	Certificates/certification numbers	STW(STB)775 S
	Inspection basis	DIN EN 14597
	Valid for	Type 602021/0020 (EM-20), Type 602021/0030 (EM-30)
	Designation	DIN
	Testing agency	TÜV Süd
	Certificates/certification numbers	B <sub>10d</sub> = 250,000 <sup>a</sup>
	Inspection basis	DIN EN ISO 13849-1
	Valid for	Type 602021/0020 (EM-20), Type 602021/0030 (EM-30), Type 602021/0040 (EM-40), Type 602021/0050 (EM-50)
	Designation	PED
	Testing agency	TÜV Süd
	Certificates/certification numbers	Z-IS-TAF-MUC-18-06-2652099-07102504
	Inspection basis	2014/68/EU, DIN EN 14597
	Valid for	Type 602021/0020 (EM-20), Type 602021/0030 (EM-30), Type 602021/0040 (EM-40), Type 602021/0050 (EM-50)
	Designation	UL
	Testing agency	UL
	Certificates/certification numbers	E66358
	Inspection basis	UL 873, CSA-22.2 No. 24
	Valid for	Type 602021/0001 (EM-1), Type 602021/0002 (EM-2), Type 602021/0003 (EM-3), Type 602021/0004 (EM-4), Type 602021/0005 (EM-5), Type 602021/0020 (EM-20), Type 602021/0030 (EM-30), Type 602021/0040 (EM-40), Type 602021/0044 (EM-44), Type 602021/0050 (EM-50), Type 602021/0133 (EM-133)

## 7 Technical data

	Designation Testing agency Certificates/certification numbers Inspection basis Valid for	UL UL MH45736 UL 353, CSA-22.2 No. 24 Type 602021/... (EM-....)
	Designation Testing agency Certificates/certification numbers Inspection basis Valid for	EAC <sup>b</sup> Gost Norm AG TC RU C-DE.AB98.B.00348 Technical rules of the customs union Russia/Belarus/Kazakhstan Type 602021/... (EM-....)
	Designation Testing agency Certificates/certification numbers Inspection basis Valid for	Railway application JUMO - EN 50155 Type 602021/... (EM-....) with extra code 950

<sup>a</sup> For detailed information please refer to safety manual JUMO EM602021, 602026.

<sup>b</sup> Russian documentation available upon request.

# 8 Shutdown

---

## 8.1 Maintenance

The device is maintenance-free.

## 8.2 Cleaning

Do not damage the device, especially the wetted parts.

The cleaning agent must not attack the surface and seals

## 8.3 Dismounting

Requirements:

- The system has been de-energized and secured against being switched on again.

## 8.4 Returns

Procedure:

1. The [supplementary sheet for product returns](#) must first be completed correctly and signed. Then enclose it with the shipping documents and attach it to the packaging, ideally on the outside.
2. Use the original packaging or a suitably secure container for sending the device.

## 8.5 Disposal



### DISPOSAL

- Do not dispose of the device or replacement parts in the trash bin after use.
- Delete programs and data stored on the device.
- Remove batteries if present, if possible without damaging the device.
- Dispose of the device and packaging properly and in an environmentally friendly way.
- Observe country-specific laws and regulations for waste management and disposal.

According to Directive 2012/19/EU on Waste Electrical and Electronic Equipment, manufacturers are obliged to offer the possibility of taking back old equipment. Inquire about returning it to the manufacturer.

---

**JUMO GmbH & Co. KG**

Moritz-Juchheim-Straße 1  
36039 Fulda, Germany

Tel.: +49 661 6003-0  
Fax: +49 661 6003-500

E-Mail: mail@jumo.net  
Internet: www.jumo.net



More than **sensors + automation**

## EU-Konformitätserklärung

EU declaration of conformity / Déclaration UE de conformité

**Dokument-Nr.**

*Document No. / Document n°.*

CE 639

**Hersteller**

*Manufacturer / Etabli par*

JUMO GmbH & Co. KG

**Anschrift**

*Address / Adresse*

Moritz-Juchheim-Straße 1, 36039 Fulda, Germany

**Produkt**

*Product / Produit*

**Name**

*Name / Nom*

**Typ**

*Type / Type*

**Typenblatt-Nr.**

*Data sheet no. / N°*

*Document*

*d'identification*

Einbau-Thermostat EM

602021

602021

**Produktbeschreibung**

*Product description / Description du produit*

Elektromechanischer Einbau-Thermostat.

**Wir erklären in alleiniger Verantwortung, dass das bezeichnete Produkt die Anforderungen der Europäischen Richtlinien erfüllt.**

*We hereby declare in sole responsibility that the designated product fulfills the requirements of the European Directives.*

*Nous déclarons sous notre seule responsabilité que le produit remplit les Directives Européennes.*

Dokument-Nr.

*Document No. / Document n°.*

CE 639

EU-Konformitätserklärung

Seite: 1 von 5

# 9 Declaration of conformity

## JUMO GmbH & Co. KG

Moritz-Juchheim-Straße 1  
36039 Fulda, Germany

Tel.: +49 661 6003-0  
Fax: +49 661 6003-500

E-Mail: mail@jumo.net  
Internet: www.jumo.net



More than **sensors + automation**

### 1. Richtlinie

*Directive / Directive*

**Name** EMC 2014/30/EU

*Name / Nom*

**Konformitätsbewertungsverfahren** Mod. A

*Conformity assessment procedure /*

*Procédure d'évaluation de la conformité*

**Datum der Erstanbringung des CE-Zeichens** 1996

**auf dem Produkt**

*Date of first application of the CE mark to the product /*

*Date de 1ère application du sigle sur le produit*

### Angewendete Normen/Spezifikationen

*Standards/Specifications applied / Normes/Spécifications appliquées*

#### Referenz

*Reference / Référence*

EN 60730-1

#### Ausgabe

*Edition / Édition*

2016+A1:2019

#### Bemerkung

*Comment / Remarque*

The edition 2011 is met for  
presumption of conformity

EN 60730-2-9

2019+A1:2019+A2:2020

The edition 2010 is met for  
presumption of conformity

### Gültig für Typ

*Valid for Type / Valable pour le type*

602021/...

### 2. Richtlinie

*Directive / Directive*

**Name** LVD 2014/35/EU

*Name / Nom*

**Konformitätsbewertungsverfahren** Mod. A

*Conformity assessment procedure /*

*Procédure d'évaluation de la conformité*

**Datum der Erstanbringung des CE-Zeichens** 1995

**auf dem Produkt**

*Date of first application of the CE mark to the product /*

*Date de 1ère application du sigle sur le produit*

Dokument-Nr.

Document No. / Document n°.

CE 639

EU-Konformitätserklärung

Seite: 2 von 5

# 9 Declaration of conformity

## JUMO GmbH & Co. KG

Moritz-Juchheim-Straße 1  
36039 Fulda, Germany

Tel.: +49 661 6003-0  
Fax: +49 661 6003-500

E-Mail: mail@jumo.net  
Internet: www.jumo.net



More than **sensors + automation**

### Angewendete Normen/Spezifikationen

*Standards/Specifications applied / Normes/Spécifications appliquées*

<b>Referenz</b> <i>Reference / Référence</i>	<b>Ausgabe</b> <i>Edition / Édition</i>	<b>Bemerkung</b> <i>Comment / Remarque</i>
EN 60730-1	2016+A1:2019	The edition 2011 is met for presumption of conformity
EN 60730-2-9	2019+A1:2019+A2:2020	The edition 2010 is met for presumption of conformity

### Gültig für Typ

*Valid for Type / Valable pour le type*

602021/...

### 3. Richtlinie

*Directive / Directive*

**Name** PED 2014/68/EU

*Name / Nom*

**Konformitätsbewertungsverfahren** Mod. B(B)+D

*Conformity assessment procedure /*

*Procédure d'évaluation de la conformité*

**Datum der Erstanbringung des CE-Zeichens** 1996

**auf dem Produkt**

*Date of first application of the CE mark to the product /*

*Date de 1ère application du sigle sur le produit*

### Gültig für Typ

*Valid for Type / Valable pour le type*

602021/...

### 3.1 EU-Baumusterprüfbescheinigung

*EU type examination certificate / Certificat d'examen de type UE*

**Zertifikatsnummer** Z-IS-TAF-MUC-18-06-2652099-07102504

*Certificate number / Numéro de certificat*

**Notifizierte Stelle** TÜV SÜD Industrie Service GmbH,  
Westendstraße 199, 80686 München, Germany

*Notified Body / Organisme notifié*

Dokument-Nr.  
Document No. / Document n°.

CE 639

EU-Konformitätserklärung

Seite: 3 von 5

# 9 Declaration of conformity

## JUMO GmbH & Co. KG

Moritz-Juchheim-Straße 1  
36039 Fulda, Germany

Tel.: +49 661 6003-0  
Fax: +49 661 6003-500

E-Mail: mail@jumo.net  
Internet: www.jumo.net



More than **sensors + automation**

### Angewendete Normen/Spezifikationen

*Standards/Specifications applied / Normes/Spécifications appliquées*

#### Referenz

*Reference / Référence*

DIN EN 14597

#### Ausgabe

*Edition / Édition*

2015-02

#### Bemerkung

*Comment / Remarque*

### Qualitätssicherung bezogen auf den Produktionsprozess

*Quality assurance of the production process / L'assurance de la qualité de la production*

#### Zertifikatsnummer

*Certificate number / Numéro de certificat*

DGR-0036-QS-989-20 Rev.1

#### Notifizierte Stelle

*Notified Body / Organisme notifié*

TÜV SÜD Industrie Service GmbH,  
Westendstraße 199, 80686 München, Germany

#### Kennnummer

*Identification no. / N° d'identification*

0036

## 4. Richtlinie

*Directive / Directive*

#### Name

*Name / Nom*

RoHS 2011/65/EU

#### Konformitätsbewertungsverfahren

*Conformity assessment procedure /  
Procédure d'évaluation de la conformité*

Mod. A

#### Datum der Erstanbringung des CE-Zeichens

*Date of first application of the CE mark to the product /  
Date de 1ère application du sigle sur le produit*

2017

### Angewendete Normen/Spezifikationen

*Standards/Specifications applied / Normes/Spécifications appliquées*

#### Referenz

*Reference / Référence*

VDK Umweltrelevante Aspekte V1  
bei der Produktentwicklung und  
-gestaltung

#### Ausgabe

*Edition / Édition*

#### Bemerkung

*Comment / Remarque*

Dokument-Nr.  
Document No. / Document n°.

CE 639

EU-Konformitätserklärung

Seite: 4 von 5



# 9 Declaration of conformity

## JUMO GmbH & Co. KG

Moritz-Juchheim-Straße 1  
36039 Fulda, Germany

Tel.: +49 661 6003-0  
Fax: +49 661 6003-500

E-Mail: mail@jumo.net  
Internet: www.jumo.net



More than **sensors + automation**

## Gültig für Typ

*Valid for Type / Valable pour le type*

602021/...

## Aussteller

*Issued by / Etabli par*

JUMO GmbH & Co. KG

## Ort, Datum

*Place, date / Lieu, date*

Fulda, 2021-10-06

## Rechtsverbindliche Unterschriften

*Legally binding signatures /*

*Signatures juridiquement valable*

Bereichsleitung Globaler Vertrieb  
i. V. Markus Belmer

Qualitätsbeauftragter und Leiter Qualitätswesen  
i. V. Harald Gienger

Dokument-Nr.  
Document No. / Document n°.

CE 639

EU-Konformitätserklärung

Seite: 5 von 5

# 10 China RoHS

		 <small>More than sensors + automation</small>					
产品组别 Product group: 602021		<b>产品中有害物质的名称及含量</b> <b>China EEP Hazardous Substances Information</b>					
部件名称 Component Name							
		铅 (Pb)	汞 (Hg)	镉 (Cd)	六价铬 (Cr(VI))	多溴联苯 (PBB)	多溴二苯醚 (PBDE)
外壳 Housing (Gehäuse)		X	○	○	○	○	○
过程连接 Process connection (Prozessanschluss)		○	○	○	○	○	○
螺母 Nuts (Mutter)		○	○	○	○	○	○
螺栓 Screw (Schraube)		○	○	○	○	○	○
<p>本表格依据SJ/T 11364的规定编制。                  This table is prepared in accordance with the provisions SJ/T 11364.                  ○：表示该有害物质在该部件所有均质材料中的含量均在GB/T 26572规定的限量要求以下。                  Indicate the hazardous substances in all homogeneous materials' for the part is below the limit of the GB/T 26572.                  ×：表示该有害物质至少在该部件的某一均质材料中的含量超出GB/T 26572规定的限量要求。                  Indicate the hazardous substances in at least one homogeneous materials' of the part is exceeded the limit of the GB/T 26572.</p>							





**JUMO GmbH & Co. KG**

Street address:  
Moritz-Juchheim-Straße 1  
36039 Fulda, Germany

Delivery address:  
Mackenrodtstraße 14  
36039 Fulda, Germany

Postal address:  
36035 Fulda, Germany

Phone: +49 661 6003-0  
Fax: +49 661 6003-607  
Email: [mail@jumo.net](mailto:mail@jumo.net)  
Internet: [www.jumo.net](http://www.jumo.net)

**JUMO Instrument Co. Ltd.**

JUMO House  
Temple Bank, Riverway  
Harlow, Essex, CM20 2DY, UK

Phone: +44 1279 63 55 33  
Fax: +44 1279 62 50 29  
Email: [sales@jumo.co.uk](mailto:sales@jumo.co.uk)  
Internet: [www.jumo.co.uk](http://www.jumo.co.uk)

**JUMO Process Control, Inc.**

6724 Joy Road  
East Syracuse, NY 13057, USA

Phone: +1 315 437 5866  
Fax: +1 315 437 5860  
Email: [info.us@jumo.net](mailto:info.us@jumo.net)  
Internet: [www.jumousa.com](http://www.jumousa.com)

