

# JUMO flowTRANS MAG I02

Electromagnetic flowmeter  
for liquids



Operating Manual



40601100T90Z001K000

V3.00/EN/00690082



<b>1</b>	<b>General information and notes for the reader</b>	<b>6</b>
1.1	Symbols and signal words	7
1.2	Definition of terms	7
<b>2</b>	<b>Intended use</b>	<b>8</b>
<b>3</b>	<b>Basic safety information</b>	<b>9</b>
<b>4</b>	<b>General information</b>	<b>11</b>
4.1	Warranty conditions	11
4.2	Information available online	11
<b>5</b>	<b>Design and function</b>	<b>12</b>
5.1	General information	12
5.1.1	Design and function	12
5.1.2	Block diagram	12
5.2	Areas of application	12
5.3	Nameplate	13
<b>6</b>	<b>Technical data</b>	<b>14</b>
6.1	Measuring range and accuracy	14
6.2	Measurement media	14
6.3	Mechanical features	15
6.3.1	Materials	15
6.3.2	Pressure temperature diagram	15
6.4	Electrical data	16
6.5	Connecting cable	17
6.6	Environmental influences	17
6.7	Compliance with standards and directives	17
<b>7</b>	<b>Mounting</b>	<b>18</b>
7.1	Safety information	18
7.2	Installation into the pipeline	20
7.2.1	Recommendation for installing into the pipeline	20
7.2.2	Installation in a pipeline with G 2" union nut	22
7.3	Electrical connection	23
7.3.1	Make sure that the potential is equal in the installation	24
7.3.2	Use of a cable holder	25

---

# Contents

---

7.3.3	Terminal assignment and use of a selection switch	26
7.3.4	Connecting the digital input DI1	28
7.3.5	Connection for the current output AO1	29
7.3.6	Connecting the transistor output DO1	30
7.3.7	Connecting the relay outputs DO2 and DO3	30
<b>8</b>	<b>Startup and parameterization</b>	<b>31</b>
8.1	Safety information	31
8.2	Operating levels	32
8.3	Display, navigation keys and status LEDs	34
8.4	Using the navigation keys	35
8.5	Process level details	36
8.6	Parameter menu details	37
8.6.1	Choosing the display language	38
8.6.2	Choosing the flow rate unit, the number of decimals, and the counter display unit	38
8.6.3	Entering the K-factor for the fitting (406090) used	40
8.6.4	Determining the fitting's K-factor with a calibration procedure (Teach-In)	41
8.6.5	Configuring outputs	44
8.6.6	Configuring current output AO1	45
8.6.7	Configuring the transistor output DO1 as a pulse output	46
8.6.8	Configuring the transistor output DO1 to switch a load depending on two threshold values	47
8.6.9	Configuring the transistor output DO1 to switch a load when the direction of flow changes	50
8.6.10	Configuring the transistor output DO1 to switch a load when the device generates a warning	51
8.6.11	Configuring the relay outputs DO2 and DO3	52
8.6.12	Configuring the digital input DI1	55
8.6.13	Adjusting the filter to the measured flow rate	61
8.6.14	Resetting both counters	62
8.6.15	Adjusting the mains frequency	63
8.6.16	Adjusting the CUT-OFF flow rate	63
8.6.17	Setting display backlight and how long it stays on, or deactivating the backlight	64
8.7	Test menu details	65
8.7.1	Adjusting the current output AO1	66
8.7.2	Calibrate the flow rate zero point	67
8.7.3	Checking proper response of the outputs	70
8.7.4	Changing the sensor's KW value	70
8.7.5	Monitoring the flow rate in the pipeline	71
8.8	Information menu details	72
<b>9</b>	<b>Maintenance</b>	<b>73</b>
9.1	Safety information	73
9.2	Returning devices	74
9.3	Cleaning the device and sensor	74
9.4	Replace the seal (device with G 2" union nut)	75
9.5	Troubleshooting	76

---

# Contents

---

9.5.1	Solving a problem with the device status LED . . . . .	76
9.5.2	Solving a problem without a warning or error message with the device status LED. . . . .	76
9.5.3	Solving a problem without a warning or error message with a green device status LED . . . . .	78
9.5.4	Solving a problem with a warning or error message with the red device status LED . . . . .	79
9.5.5	Solving a problem with a warning or error message with the orange device status LED . . . . .	80
<b>10</b>	<b>Spare parts and accessories . . . . .</b>	<b>82</b>
<b>11</b>	<b>Packaging and transport . . . . .</b>	<b>83</b>
<b>12</b>	<b>Storage . . . . .</b>	<b>84</b>
<b>13</b>	<b>Disposal . . . . .</b>	<b>85</b>
<b>14</b>	<b>China RoHS . . . . .</b>	<b>86</b>

---

# 1 General information and notes for the reader

---

Before mounting and starting up the unit, this manual must be read carefully.

The manual is an integral part of the product and must be stored for subsequent use. In the interest of clarity, the manual does not contain all the detailed information about all product versions and cannot take into consideration every conceivable case involving the installation, operation or maintenance.

If you would like further information or if problems occur that are not covered by the manual, the required information can be obtained from the manufacturer.

The contents of this manual are not part of or a change to a previous or existing agreement, assurance or legal relationship.

This product is built based on state-of-the-art technology and safe to use. It has been tested and was shipped from the factory in perfect working order. To maintain this condition for its service life, the information contained in these instructions must be observed and followed.

Modifications and repairs to the product may only be performed if expressly permitted by this manual.

Optimum protection of the personnel and the environment and the safe and smooth operation of this product are only ensured by observing all the safety information as well as all safety and warning symbols contained in this manual.

Notes and symbols attached directly on the product must be observed. They may not be removed and must be fully legible at all times.

The symbol on the nameplate refers to:

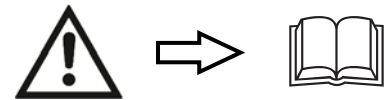

# 1 General information and notes for the reader

---

## 1.1 Symbols and signal words



### **DANGER – Serious damage to health / risk to life!**

This symbol in connection with the signal word "danger" indicates an imminent threat of danger. Failure to observe the safety information results in death or serious injuries.

---



### **WARNING – Injuries to persons!**

This symbol in connection with the signal word "warning" indicates a potentially dangerous situation. Failure to observe the safety information may result in death or serious injuries.

---



### **CAUTION – Minor injuries!**

This symbol in connection with the signal word "caution" indicates a potentially dangerous situation. Failure to observe the safety information may result in minor or moderate injuries. It may also be used for warnings against property damage.

---



### **CAUTION – Property damage!**

This symbol indicates a potentially harmful situation. Failure to observe the safety information may damage or destroy the device and/or other system parts.

---



### **NOTE!**

This symbol indicates user tips, particularly useful or important information about the device; or its additional uses. This is not a signal word for a dangerous or harmful situation.

---



### **NOTE!**

This symbol is used in tables and indicates that further information is provided after the table.

---

## 1.2 Definition of terms

In this manual, the term "device" always refers to the electromagnetic flowmeter (406011).

In this manual, the terms "medium", "media", "measurement media", "fluid" and "fluids" always refer to liquid or liquids.

## 2 Intended use

---



### **NOTE!**

Failure to use this device correctly may pose a danger to people, surrounding machinery, and the environment.

---

This device is intended solely for the purpose of measuring the flow rate of liquids.

- During application, the admissible data and operating conditions specified in the legal documents and operating manual must be observed.
- Protect the device from electromagnetic interference, UV radiation, and the weather (when using outside).
- Only ever use the device when it is free from faults.
- Proper storage, transport, installation and handling are all essential pre-requisites for safe and correct device operation.
- Only ever use the device for its intended purpose.



## 3 Basic safety information

---

This safety information does not account for:

- Random events or incidents that may occur during installation, operation, and maintenance of the device
- Local safety requirements; the operator is responsible for compliance with any such regulations, including with regard to installation and maintenance specialists.



### **Risk of injury resulting from high pressure levels within the plant!**

Before working on the system, switch off the pressure and bleed/empty the lines.

---



### **Risk of electric shocks!**

Restrict the maximum operating voltage to DC 35 V if the unit is used in a humid environment or outdoors.

Before working on the system or device, switch off the voltage and secure it so that it cannot switch on again.

Always observe the relevant accident prevention regulations and safety requirements for electrical devices.

Do not touch electronic components when they are live!

---



### **Risk of injury due to high fluid temperatures!**

Always use safety gloves to touch the device.

Stop circulation of medium and empty the pipelines before disconnecting the process connections.

---



### **Risk of injury resulting from the type of medium!**

When using dangerous media, always observe the specifications on the safety sheet and the relevant accident prevention regulations.

---



### **General dangerous situations**

Observe the following to protect against injuries:

- Do not use the device in potentially explosive areas.
  - Do not use the device in an environment that is not compatible with the materials used to make the device.
  - Do not use any media that are not compatible with the materials used to make the device.
  - Do not place the device under mechanical strain.
  - Do not modify the device.
  - Do not operate the system unsupervised.
  - All installation and maintenance work must always be performed by authorized and qualified personnel using suitable tools.
  - If the power supply is interrupted, the restart process must be defined or controlled.
  - Always observe general technical rules when planning application of the device and when operating it.
-

## 3 Basic safety information

---



**NOTE!**

The device may be damaged by the medium.

Systematically check the chemical compatibility of the materials used to make the device and the media with which the device comes into contact (for example: alcohols, strong or concentrated acids, aldehydes, bases, ester, aliphatic compounds, ketone, aromatic or halogenated hydrocarbons, oxidizing agents, and chlorinated substances).

---



**NOTE!**

Components/modules at risk of static electricity

The device contains elements that are sensitive to electrostatic discharge. Any such element shall be at risk of damage if it comes into contact with electrostatically charged persons or objects. In the worst case scenario, the component could be destroyed immediately or fail after startup.

Observe the requirements under EN 61340-5-1 to minimize or eliminate potential damage in the event of sudden electrostatic damage.

---

### 4.1 Warranty conditions

Improper use, failure to observe this manual, the use of underqualified personnel, or unauthorized modifications releases the manufacturer from liability for any resulting damage. In these cases, the manufacturer's warranty no longer applies.

### 4.2 Information available online



**NOTE!**

All the documentation, declarations of conformity and certificates are also available in the download area at [www.jumo.de](http://www.jumo.de).

---

# 5 Design and function

## 5.1 General information

### 5.1.1 Design and function

The device consists of a transducer (sensor) and a transmitter with a display. The transducer operates according to Faraday's law of induction.

The flowmeter is equipped with an analog output (current output AO1, 4 to 20 mA), a digital output (transistor output DO1, basic setting: pulse output), and two counters.

It also has two digital outputs (relay outputs DO2 and DO3) and one digital input (DI1).

The device operates as a three-wire system and requires a voltage supply between DC 18 to 36 V.

The electrical connection takes the form of two cable fittings (M20 × 1.5) connected to the electronic board's terminal strips inside the transmitter.

### 5.1.2 Block diagram

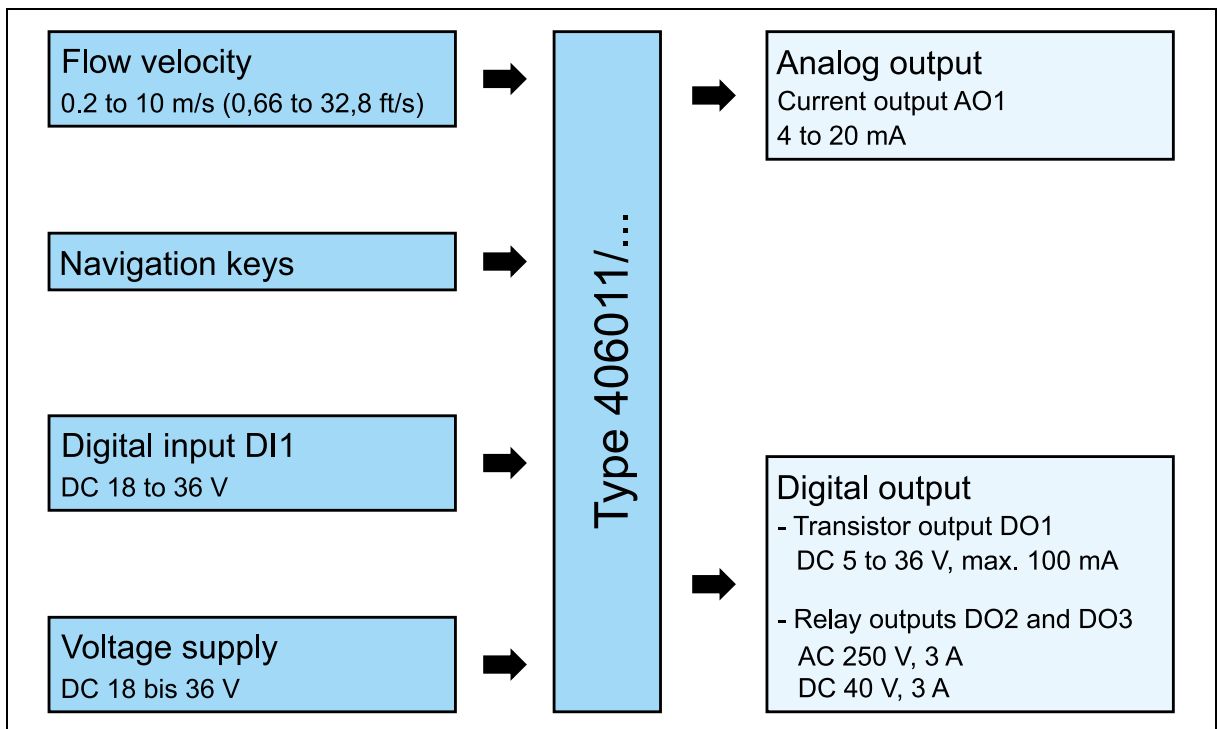

## 5.2 Areas of application

This flowmeter is intended solely for the purpose of measuring the flow rate of liquids (media or measured media), ⇒ see chapter 2 "Intended use", page 8.

The adjustable transistor output and the two relay outputs enable the device to switch a solenoid valve or activate an alarm. The current output (4 to 20 mA) allows a control circuit to be created.

The digital input enables a function to be triggered remotely.

### 5.3 Nameplate

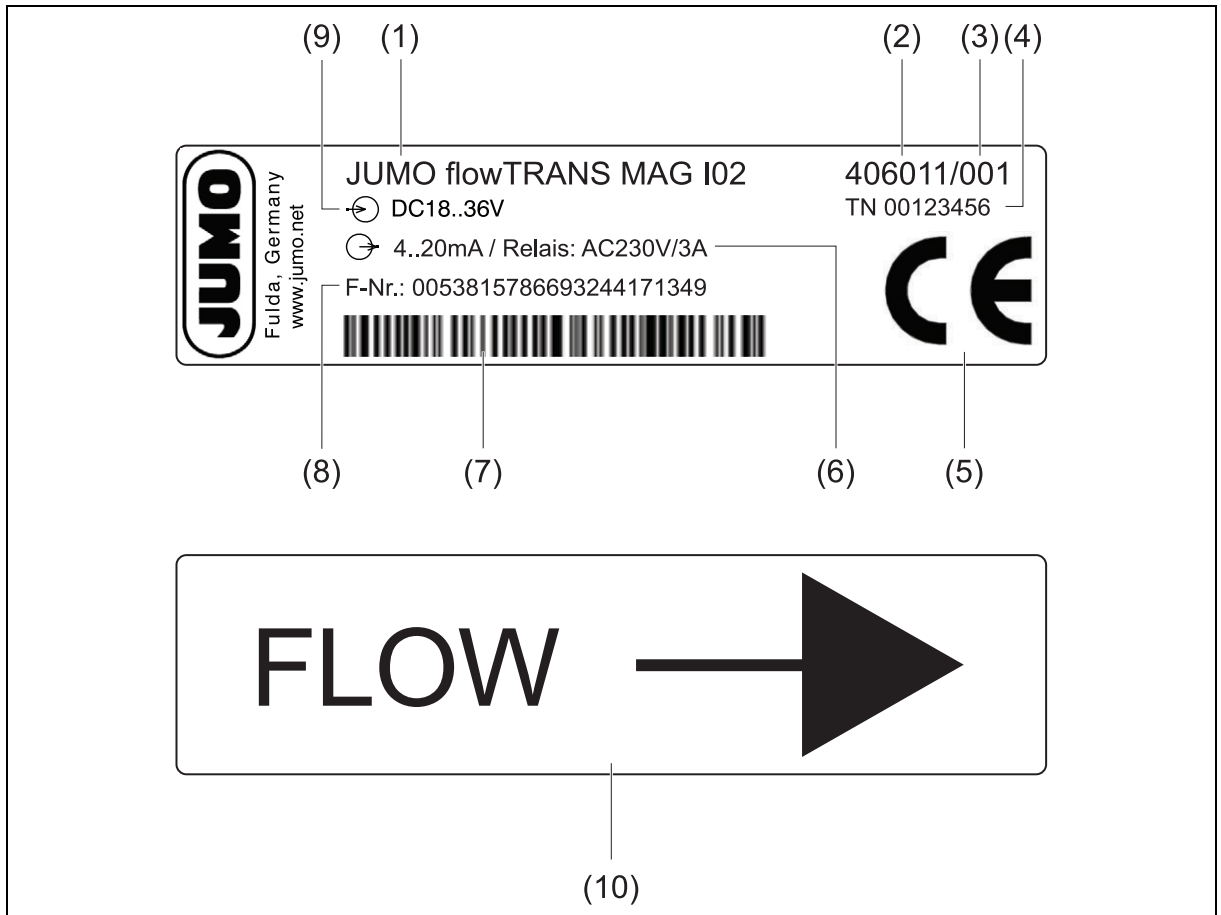

- (1) Manufacturer and device designation
- (2) Product group number
- (3) Sensor version
- (4) Part no.
- (5) Conformity label
- (6) Current/relay output data
- (7) Barcode
- (8) Fabrication number
- (9) Voltage supply / digital input data
- (10) Flow direction

## 6 Technical data

### 6.1 Measuring range and accuracy

Flow velocity	0.2 to 10 m/s (0,66 to 32,8 ft/s)
Measuring deviation with standard K-factor after Teach-In	$\leq \pm 3.5$ % of the measured value <sup>a</sup> $\leq \pm 0.5$ % of measured value <sup>a</sup>
Linearity	$\leq \pm 0.5$ % of measuring range limit value <sup>b</sup>
Repeatability	$\leq \pm 0.25$ % of measured value <sup>a</sup>

<sup>a</sup> under reference conditions, i. e. measurement medium = water, ambient and water temperature = 20 °C, observing the necessary inlet and outlet sections and associated fitting (406090)

<sup>b</sup> 10 m/s (32,8 ft/s)

### 6.2 Measurement media

Medium type	Neutral, contaminated, and aggressive liquids
Minimum conductivity of the medium	20 $\mu$ S/cm
Viscosity	< 1000 mPas
Medium temperature <sup>a</sup> in conjunction with fitting made of PVC PE PP Stainless steel	0 to 50 °C (32 to 122 °F) 0 to 70 °C (32 to 158 °F) 0 to 80 °C (32 to 176 °F) -15 to +110 °C (5 to 230 °F)
Medium pressure <sup>a</sup> in conjunction with fitting made of PVC PE PP Stainless steel	PN 10 (145 psi) PN 10 (145 psi) PN 10 (145 psi) PN 16 (232 psi)

<sup>a</sup>  $\Rightarrow$  see also "pressure temperature diagram", page 15

## 6.3 Mechanical features

### 6.3.1 Materials

Housing/seal	PPA, black/NBR
Union nut	PPA
Safety cap/seal	PSU/silicone
Front film	Polyester
M20 × 1.5 cable fittings/ seal	PA/neoprene
Screws	Stainless steel
Components in contact with the medium sensor Fitting	Stainless steel 316 L (1.4404), FKM, or EPDM, PEEK ⇒ See data sheet 406090

### 6.3.2 Pressure temperature diagram

Relationship between the medium pressure and temperature for a device with a stainless steel sensor and a 406090 fitting made from stainless steel, PVC, PP, or PE:

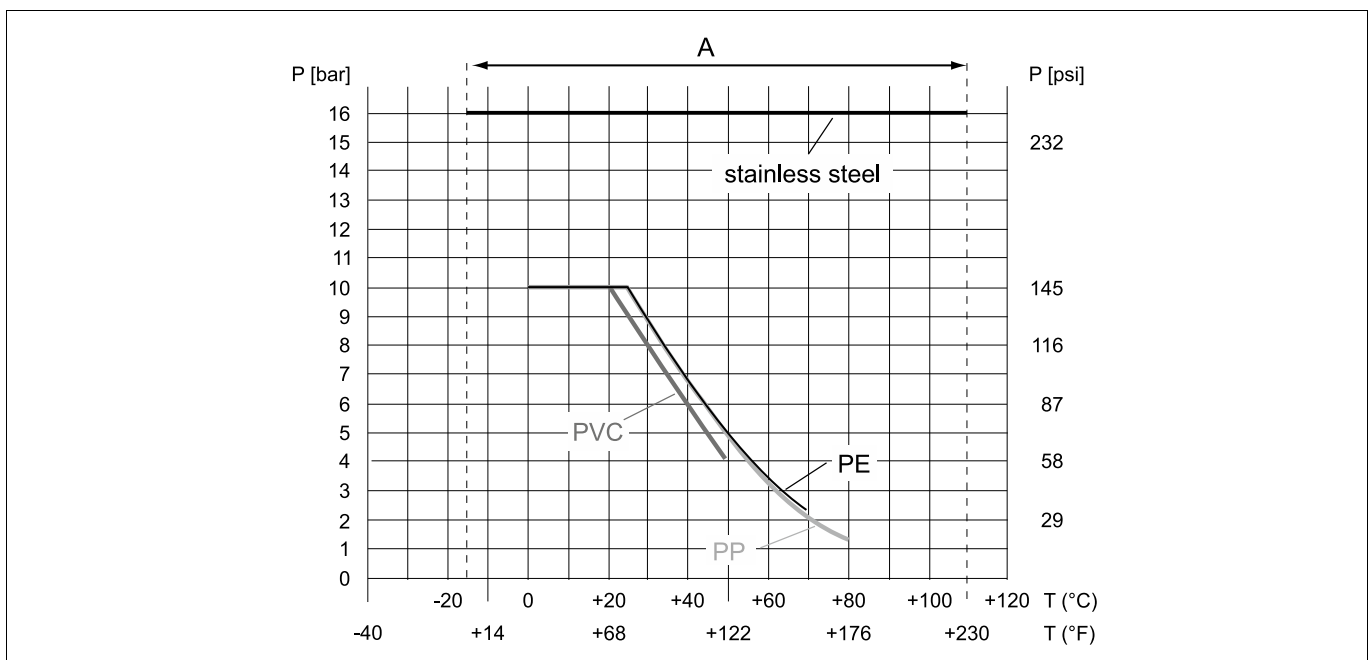

## 6 Technical data

### 6.4 Electrical data

Voltage supply	DC 18 to 36 V, filtered and regulated
Tolerance of the applied voltage	±0,5 %
Current consumption	Max. 300 mA at DC 18 V

#### Digital input DI1

Switching voltage	DC 18 to 36 V
Safety	Protected against polarity reversal and voltage peaks, galvanically isolated
Input impedance	15 kΩ
Minimum pulse length	200 ms
Switching thresholds	PLC level: logical „0“ < 7 V, logical „1“ > 10 V

#### Analog output AO1

Type	Current output
Signal range	4 to 20 mA, sink or source (depending on the connection), 22 mA for reporting faults
Load resistance	
at DC 18 V	450 Ω
at DC 24 V	700 Ω
at DC 30 V	1000 Ω
at DC 36 V	1300 Ω

#### Digital output DO1

Type	Transistor output (open-collector output), NPN/PNP (depending on connection)
Function (adjustable)	Pulse output (default setting), hysteresis/window mode, reverse flow direction message, generate a warning message
Pulse frequency	0 to 250 Hz
Switching voltage	DC 5 to 36 V
Switching current	Max. 100 mA
Duty cycle at $f > 2$ Hz	0,5
Minimum pulse length at $f < 2$ Hz	250 ms
Safety	Protected against excess voltage, polarity reversal, and short circuiting, galvanically isolated

#### Digital outputs DO2 and DO3

Type	Relay output
Function (adjustable)	Hysteresis (default setting), hysteresis/window mode, reverse flow direction message, generate a warning message
Switching output	N/O contact
Switching capacity	3 A at AC 250 V resistive load, 3 A at DC 40 V resistive load
Operating life	100000 cycles
Galvanic isolation	<b>Mixed switching of mains voltage AC 230 V and SELV or PELV voltage is not admissible due to the basic insulation between the relays!</b>



### 6.5 Connecting cable

Connection type	via two cable fittings M20 × 1.5
Cable data	
Cable type	Shielded
Cross-section	0.5 to 1.5 mm <sup>2</sup>
Cable diameter	
When using one cable per cable fitting	6 to 12 mm
When using two cables per cable fitting	4 mm, with supplied multiway seal

### 6.6 Environmental influences

Wire diameter	DN 15 to DN 400 (1/2 to 16")
Fitting	Type 406090
Inlet and outlet sections	⇒ see "Inlet and outlet sections ", page 21
Operating temperature range	-10 to +60 °C (14 to 140 °F)
Storage temperature range	-20 to +60 °C (-4 to +140 °F)
Relative humidity	< 85 %, non-condensing Height above sea level: max. 2000 m (6562 ft)
Protection type according to EN 60529	IP65,  With connected device, screwed cable glands and screwed flap cover
EMC	EN 61000-6-3, EN 61000-6-2
Safety	EN 61010-1

### 6.7 Compliance with standards and directives

The standards applied to verify conformity with EU directives are listed in the EU type examination certificate and/or the EU declaration of conformity (if applicable).

**Pressure:**

According to Article 4 (1) of the Pressure Equipment Directive 2014/68/EU, the device may only be applied under the following conditions (depending on the maximum pressure and the DN of the piping used for the medium):

Type of liquid (medium)	Requirements
Group 1 fluids, Article 4 (1) c.i.	Prohibited
Group 2 fluids, Article 4 (1) c.i.	≤ DN 32 Or > DN 32 and PN × DN ≤ 1000
Group 1 fluids, Article 4 (1) c.ii.	≤ DN 25  Or PN × DN ≤ 2000
Group 2 fluids, Article 4 (1) c.ii.	DN ≤ DN 200  Or ≤ PN 10 Or PN × DN ≤ 5000

# 7 Mounting

---

## 7.1 Safety information



### **Risk of injury resulting from high pressure levels within the system!**

Before working on the system, switch off the pressure and bleed/empty the lines.

---



### **Risk of electric shocks!**

Restrict the maximum operating voltage to DC 35 V if the unit is used in a humid environment or outdoors.

Before working on the system or device, switch off the voltage and secure it so that it cannot switch on again.

Always observe the relevant accident prevention regulations and safety requirements for electrical devices.

---



### **Risk of injury due to high fluid temperatures!**

Always use safety gloves to touch the device.

Stop medium circulation and empty the pipelines before disconnecting the process connections.

Do not touch electronic components when they are live!

---



### **Risk of injury resulting from the type of medium!**

When using dangerous media, always observe the specifications on the safety sheet and the relevant accident prevention regulations.

---



### **Risk of injury due to improper installation!**

Mounting and electrical installation processes must always be carried out by authorized and qualified personnel using suitable tools.

Refer to the operating manual for the fitting used (406090).

Install a circuit breaker or disconnect switch into the electronics circuit in the building in which the device is going to be used.

Install the circuit breaker or disconnect switch in an easily accessible location.

Mark the circuit breaker or disconnect switch as a control device for the device's power supply.

Always use suitable safety equipment (fuses and/or circuit breakers in the correct size).

Observe standard NF C 15-100/IEC 60364.

---



### **Risk of injury resulting from the system switching on unintentionally and restarting without supervision!**

Secure the system so that it cannot be operated unintentionally.

After conducting any work on the device, always make sure that a controlled restart is carried out.

---



### **Risk of injury resulting from a failure to comply with the relationship between the pressure and temperature of the measurement medium!**

Always observe the relationship between the temperature and pressure of the medium depending on the material of the fitting (406090).

⇒ See chapter 6 "Technical data", page 14 and the operating manual for the fitting used (406090).

Observe the Pressure Equipment Directive 2014/68/EU.

---



### **Risk of injury due to improper startup!**

Failing to operate the device correctly can lead to injury and damage to the device and its surroundings. Prior to startup, make sure that the operating staff are familiar with and understand the contents of the operating manual.

Any safety information and notes on proper use are particularly important.

The device/system must always be started up by staff with a sufficient level of training.

---



### **NOTE!**

Protect the device from electromagnetic interference, UV radiation, and the weather (when using outside).

---

# 7 Mounting

## 7.2 Installation into the pipeline



**Risk of injury resulting from high pressure levels within the system!**

Before working on the system, switch off the pressure and bleed/empty the lines.



**Risk of injury resulting from the type of medium!**

When using dangerous media, always observe the specifications on the safety sheet and the relevant accident prevention regulations.

The flowmeter is inserted into a fitting (406090) mounted on the pipeline.

### 7.2.1 Recommendation for installing into the pipeline

#### Flow velocity requirements

Select the fitting 406090 according to the flow velocity requirements in the pipeline.

**Example A in the diagram:**

Requirement: If the flow rate is 10 m<sup>3</sup>/h, the flow velocity should ideally be between 2 and 3 m/s.

**Solution:**

Select a pipe with DN 40.

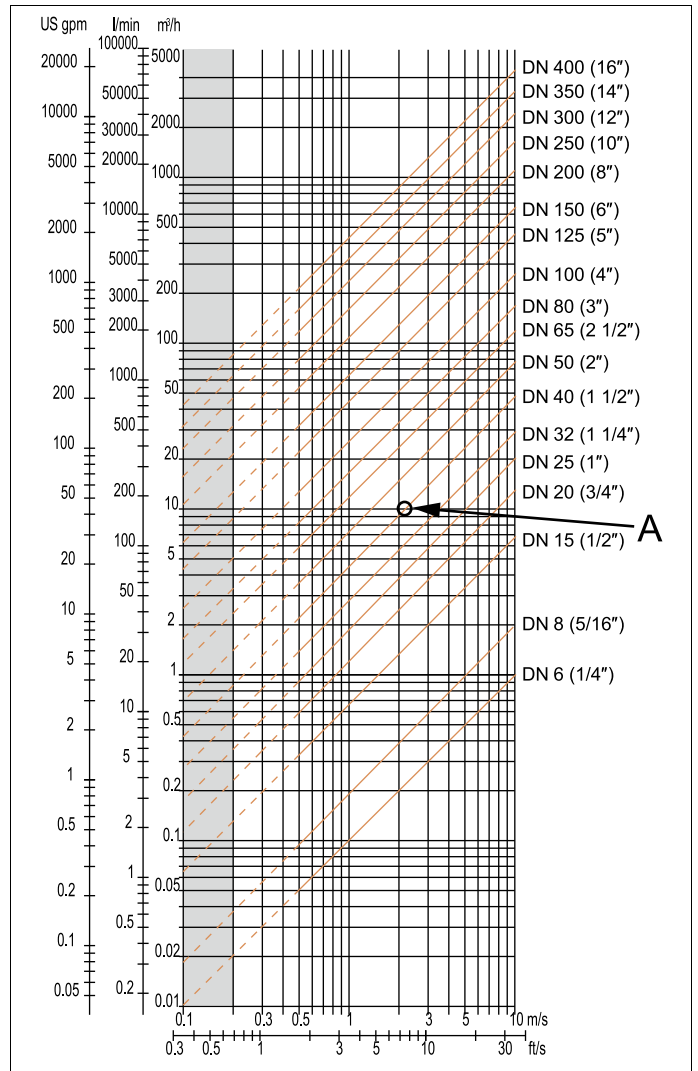

# 7 Mounting

## Installation

The device can be installed in either a horizontal or vertical pipeline.

Make sure that:

- The section of pipe around the sensor is always filled.
- The direction of flow (arrow) points upwards when installing vertically.
- The formation of bubbles is avoided in the pipeline containing the device.
- The device is always installed upstream from discharge points for liquids with increased conductivity (e.g.: acids, bases, salt solutions).

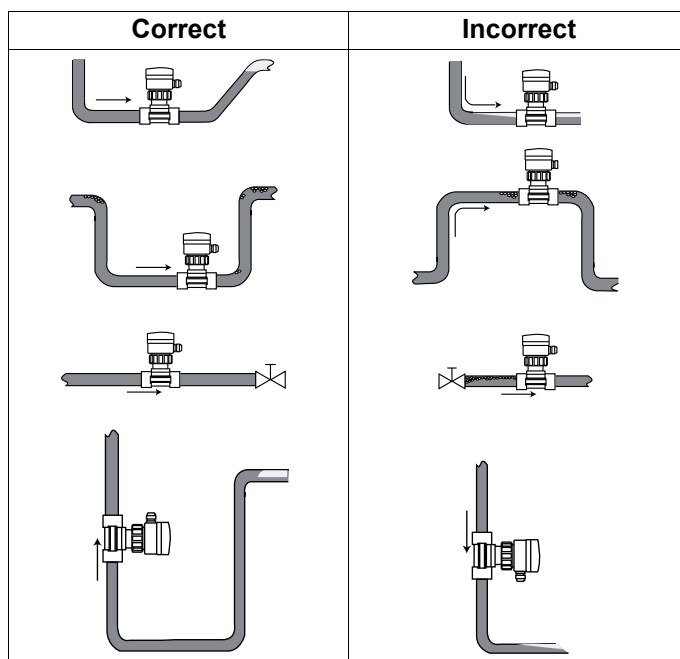

## Inlet and outlet sections

To calm the flow in the pipeline, the specified inlet and outlet sections are required at the very least.

For increased accuracy, you can make these sections of contact longer.

Direction of flow: from left to right.

DN = Nominal pipe width

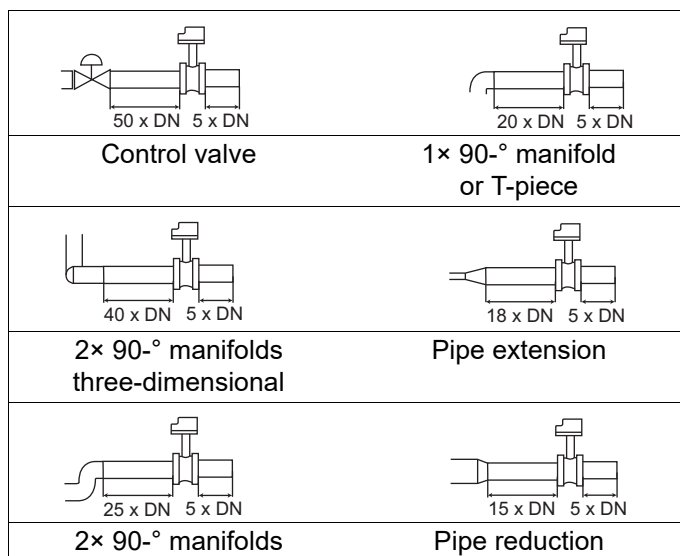

## 45° angle installation position

We recommend installing the flow rate transmitter at a 45° to the pipe's central horizontal axis.

This helps to avoid the majority of deposits on the measuring electrodes and measuring errors caused by air bubbles.

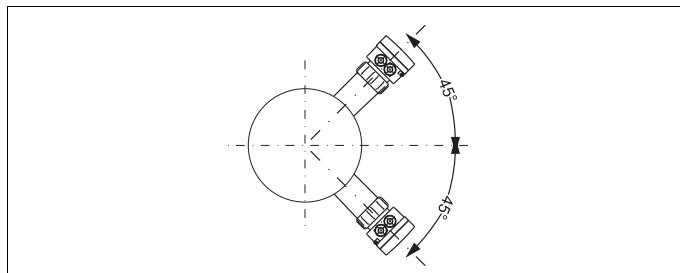

# 7 Mounting

## 7.2.2 Installation in a pipeline with G 2" union nut



### NOTE!

Please refer to the recommended installation type!

⇒ See chapter 7.2 "Installation into the pipeline", page 20 and operating manual "Fittings for flow rate sensors" (406090)



### NOTE!

To ensure more accurate measurements and good stability of the flow rate zero point, bring the sensor into contact with the measurement medium at least 24 hours prior to calibration.

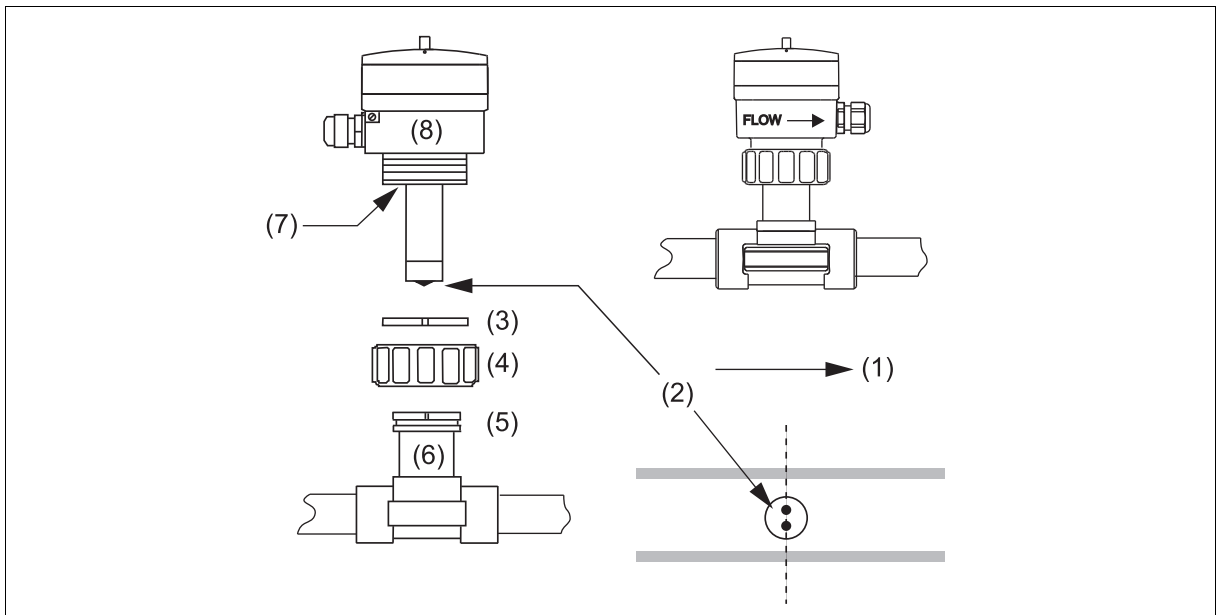

- (1) Flow direction
- (2) Measuring electrodes
- (3) Circlip
- (4) Union nut
- (5) Groove
- (6) Fitting 406090
- (7) Seal
- (8) Device

1. Install the fitting 406090 into the pipeline, ⇒ see chapter 7.2.1 "Recommendation for installing into the pipeline", page 20.
2. Check that the seal (7) is on the device (8).
3. Place the union nut (4) on the fitting (6).
4. Place the circlip (3) into the groove (5).
5. Position the device so that the arrow on the side of the housing is pointing in the direction of flow (1): the counters are incremented.
6. Place the device (8) into the fitting (6).
7. Manually tighten the union nut (4) on the device (8).

## 7.3 Electrical connection



### Risk of electric shocks!

Restrict the maximum operating voltage to DC 35 V if the unit is used in a humid environment or outdoors.

Before working on the system or device, switch off the voltage and secure it so that it cannot switch on again.

Always observe the relevant accident prevention regulations and safety requirements for electrical devices.

---



### NOTE!

The device may leak if you do not use at least one of the cable fittings.

1. Insert the provided plugs into the cable fittings not in use.
  2. Unscrew any cable fittings not in use.
  3. Remove the transparent pane.
  4. Insert the plug.
  5. Tighten the cable fitting's union nut.
- 



### NOTE!

Use a high-quality power supply (filtered and controlled).

Protect the potential equalization of the installation, ⇒ see chapter 7.3.1 "Make sure that the potential is equal in the installation", page 24.

Use a shielded cable with an operating temperature limit above 80 °C.

Avoid laying the cable near the high-voltage or high-frequency cables; if you cannot avoid doing so, maintain a minimum gap of 30 cm.

Protect the power supply with a fuse (300 mA) and circuit breaker.

Protect the relay with a fuse (max. 3 A) and an automatic circuit break (suited to the process).

Do not connect a dangerous voltage and a protective low voltage supply to the relay at the same time.

---



### NOTE!

If you are using two cables in one cable fitting, insert the multi-way seal into the cable fitting first.

---

Connect the device as follows:

1. Unscrew the screw on the flap and open the flap.
2. Loosen the four screws on the housing lid.
3. Set the lid to one side.
4. Screw on the cable fittings.
5. Guide the cable through the union nut through the cable fitting.
6. Check whether the grounding cable (from the housing) is connected as shown in the figure in chapter 7.3.3 "Terminal assignment and use of a selection switch", page 26.
7. Lay the cable according to chapter 7.3.1 "Make sure that the potential is equal in the installation", page 24 to chapter 7.3.7 "Connecting the relay outputs DO2 and DO3", page 30.

# 7 Mounting

## 7.3.1 Make sure that the potential is equal in the installation

Measures for making sure the potential is equal in the installation (voltage supply ⇒ device ⇒ measurement medium):

- Connect the various grounding points in the installation to make sure any difference in potential between two grounding points is eliminated.
- Make sure both ends of the supply cable's shielding are grounded correctly.
- Connect the negative terminal on the voltage supply to the ground to suppress the effects of common mode currents. If you cannot connect the two elements directly, you can switch a capacitor with 100 nF/50 V between the voltage supply's negative terminal and the ground.
- If the device is installed on plastic pipes, please pay particular attention to the following: direct grounding is not possible in this case. For correct grounding, connect all metallic objects close to the device (valves or pumps) to the same grounding point. If there are no metallic objects near the device, insert grounding rings into the device in both the flow direction and against the flow direction; connect these rings with the same ground. The grounding rings must be in contact with the measurement medium.

### Wiring diagrams for potential equalization in plastic pipelines

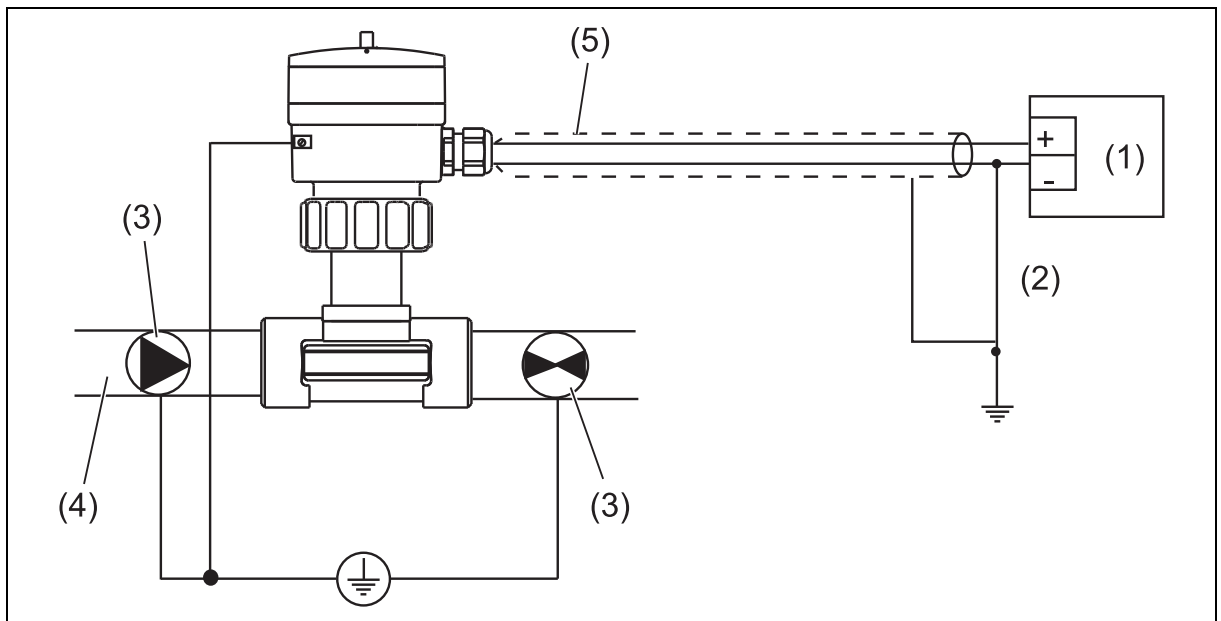

- (1) Voltage supply
- (2) If direct grounding is not possible, connect a capacitor with 100 nF/50 V between the voltage supply's negative terminal and the ground.
- (3) Pumps, motors, valves  
Alternative: Grounding rings inserted in the pipeline (not included in the scope of delivery)
- (4) Plastic pipeline
- (5) Shielding on the supply cable



## Wiring diagrams for potential equalization in metal pipelines

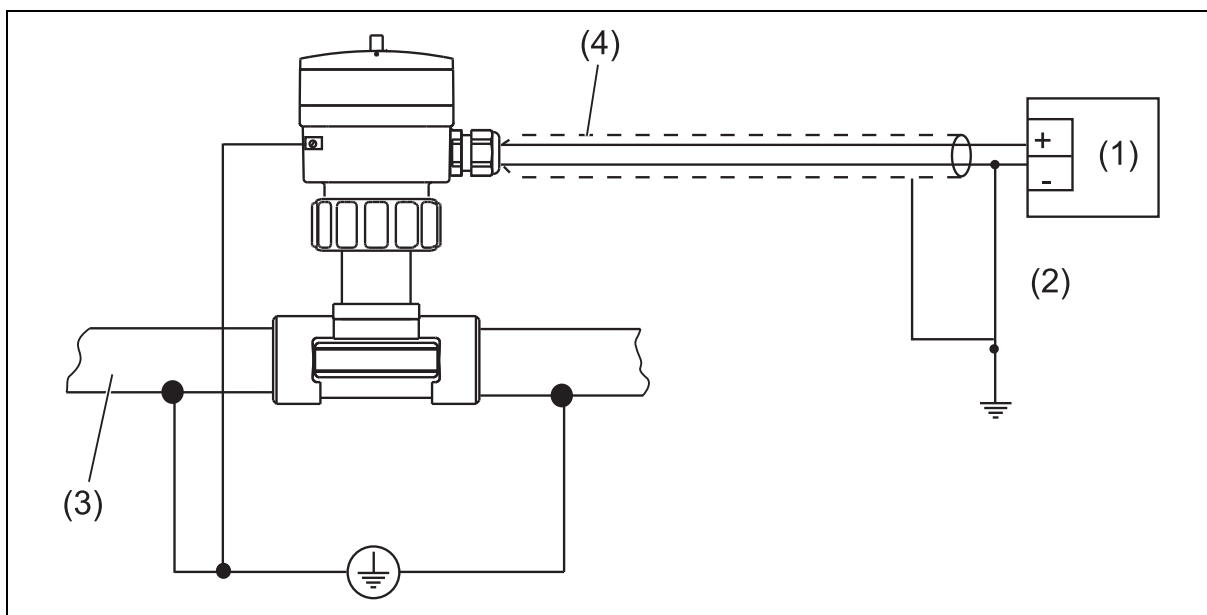

- (1) Voltage supply
- (2) If direct grounding is not possible, connect a capacitor with 100 nF/50 V between the voltage supply's negative terminal and the ground.
- (3) Metal pipeline
- (4) Shielding on the supply cable

### 7.3.2 Use of a cable holder



#### NOTE!

Before connecting the device, insert the supplied cable holder onto the electronics board.

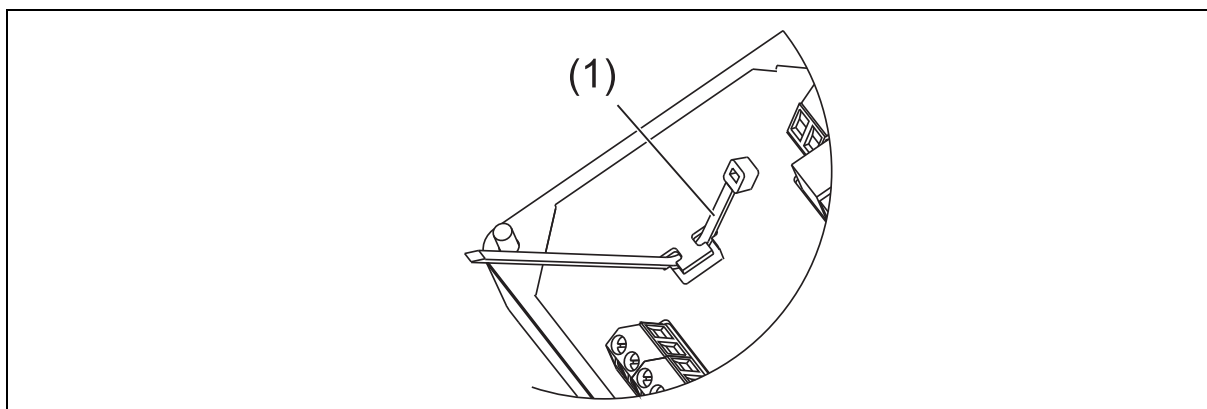

- (1) Cable holder (included in the scope of delivery)

# 7 Mounting

## 7.3.3 Terminal assignment and use of a selection switch



### HINWEIS!

#### Galvanic isolation of relay outputs DO2 and DO3

Mixed switching of mains voltage AC 230 V and SELV or PELV voltage is not admissible due to the basic insulation between the relays!

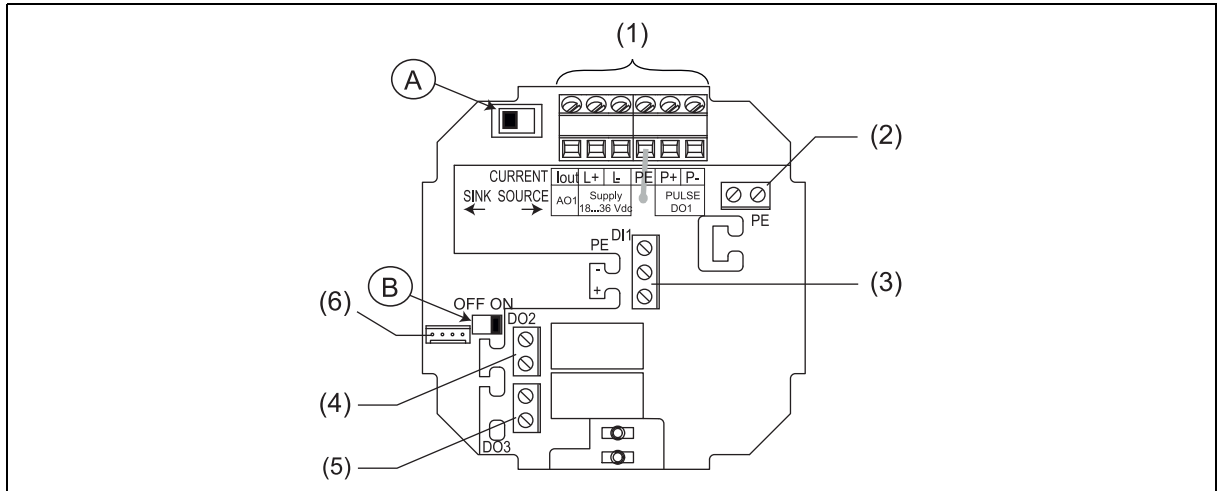

- |     |                |       |  |
|-----|----------------|-------|--|
| (1) | Terminal strip | I out | Current output AO1 (4 to 20 mA)  |
|     |                | L+    | V+ (positive power supply)   |
|     |                | L-    | 0 V (ground for the power supply)  |
|     |                | PE    | Functional ground, wired at the plant (⇒ see "Terminal strip 1: Connecting the grounding cable ", page 27) |
|     |                | P+    | Positive transistor output DO1   |
|     |                | P-    | Negative transistor output DO1   |
| (2) | Terminal strip | PE    | Shielding on the supply cable and output cables of AO1 and DO1   |
| (3) | Terminal strip | PE    | Functional ground for the cable for the DI1 digital input  |
|     |                | -     | Negative signal for the digital input DI1  |
|     |                | +     | Positive signal for the digital input DI1  |
| (4) | Terminal strip |       | Connection for the relay output DO2  |
| (5) | Terminal strip |       | Connection for the relay output DO3  |
| (6) | Terminal strip |       | 4-pin ribbon cable for connecting the sensor   |
| (A) | Switch         |       | ⇒ see "Use of the sink selection switch (right) or source selection switch (left) ", page 27               |
| (B) | Switch         |       | ⇒ see "Use of the selection switch to lock or unlock the CONFIRM key ", page 27                            |

## Use of the sink selection switch (right) or source selection switch (left)

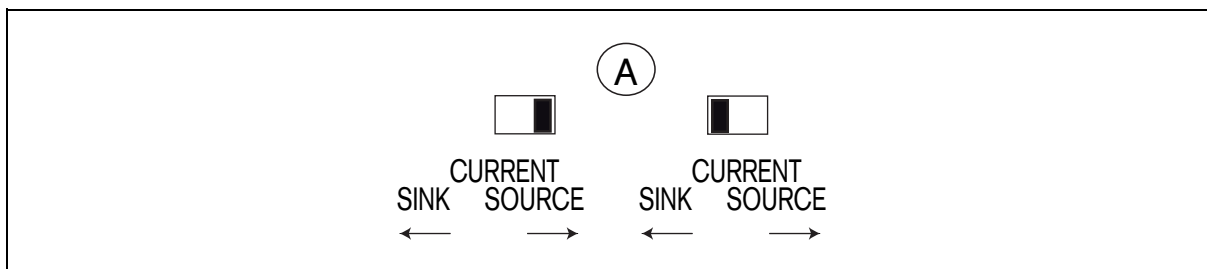

A Selection switch A is used to configure the 4 to 20 mA output as a source or sink.

## Use of the selection switch to lock or unlock the CONFIRM key

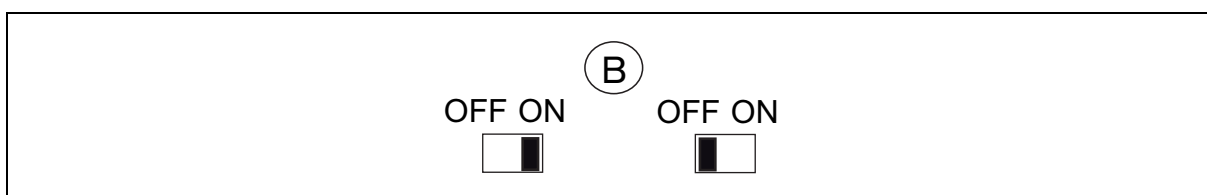

B Selection switch B is used to lock or unlock the  key in order to avoid unauthorized configuration of the device.

## Terminal strip 1: Connecting the grounding cable

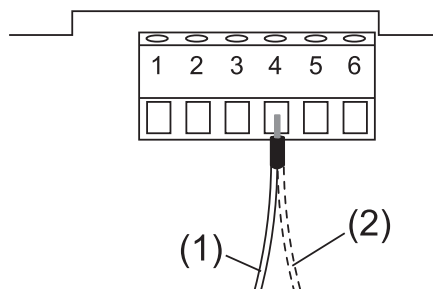

- (1) Grounding cable (from the housing)
- (2) Grounding cable (from the sensor)

# 7 Mounting

## 7.3.4 Connecting the digital input DI1

Possible connection options for the digital input DI1

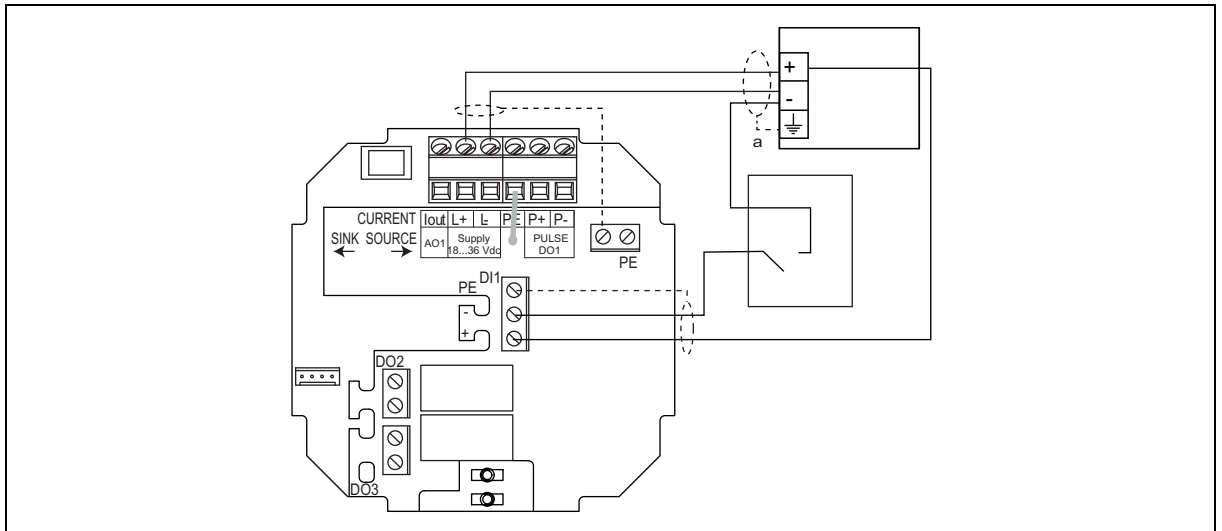
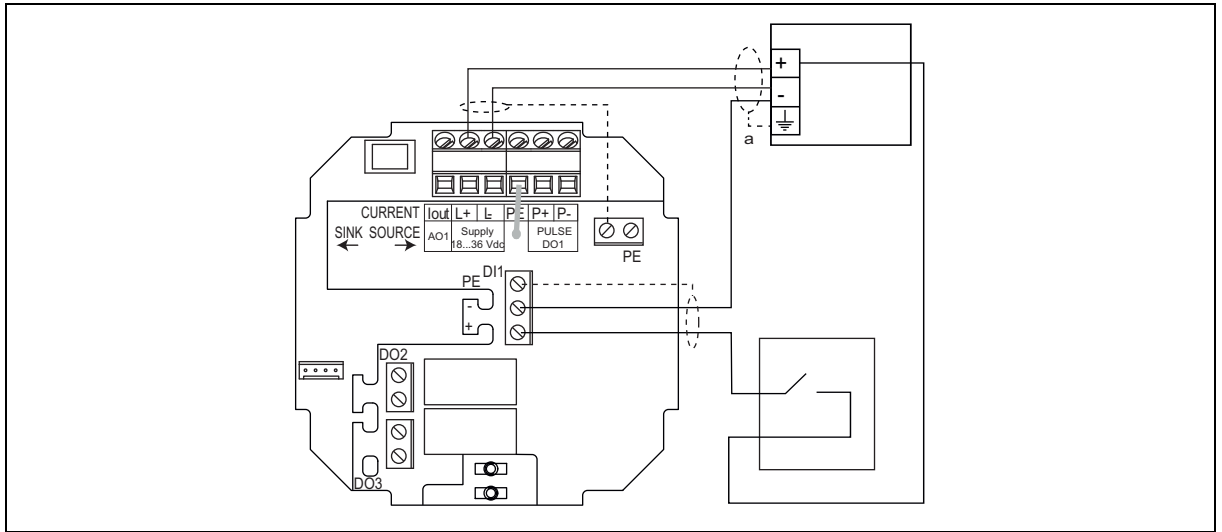

- a If direct grounding is not possible, connect a capacitor with 100 nF/50 V between the voltage supply's negative terminal and the ground.

## 7.3.5 Connection for the current output AO1



**NOTE!**

For safety reasons, secure the cable with a conductive cable holder.

The current output AO1 (4 to 20 mA) can be connected as a source or a sink.



**NOTE!**

Adjust switch A to "SOURCE".

### Connecting the current output AO1 (4 to 20 mA) as a source

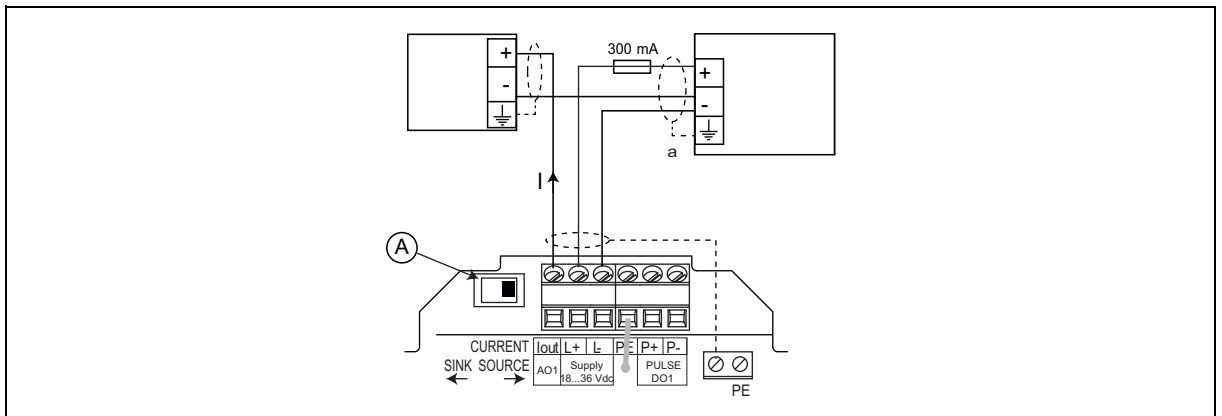

- a If direct grounding is not possible, connect a capacitor with 100 nF/50 V between the voltage supply's negative terminal and the ground.



**NOTE!**

Adjust switch A to "SINK".

### Connecting the current output AO1 (4 to 20 mA) as a sink

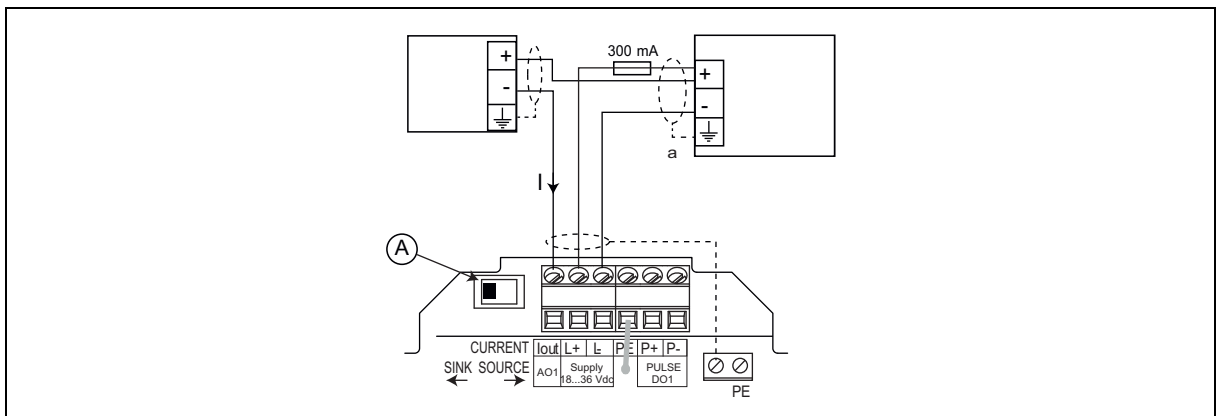

- a If direct grounding is not possible, connect a capacitor with 100 nF/50 V between the voltage supply's negative terminal and the ground.

# 7 Mounting

## 7.3.6 Connecting the transistor output DO1

### NPN connection for the transistor output DO1

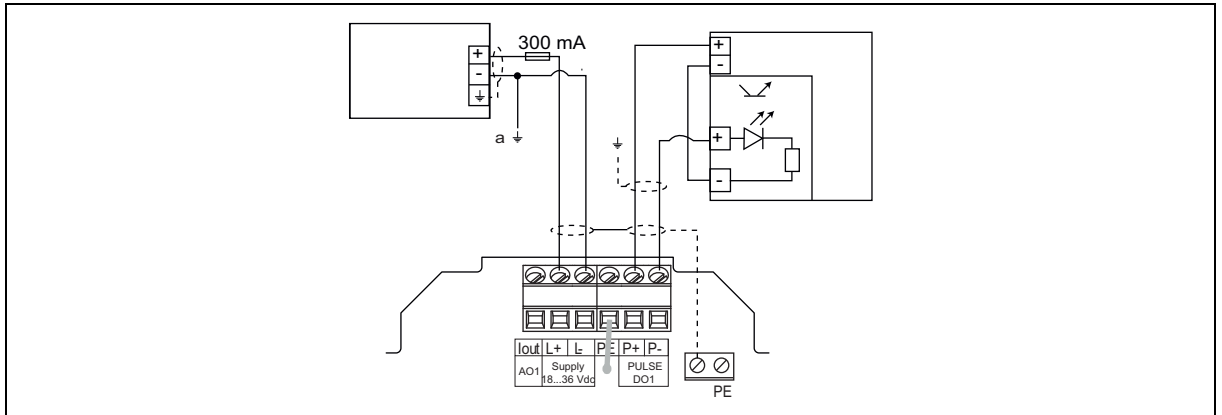

- a If direct grounding is not possible, connect a capacitor with 100 nF/50 V between the voltage supply's negative terminal and the ground.

### PNP connection for the transistor output DO1

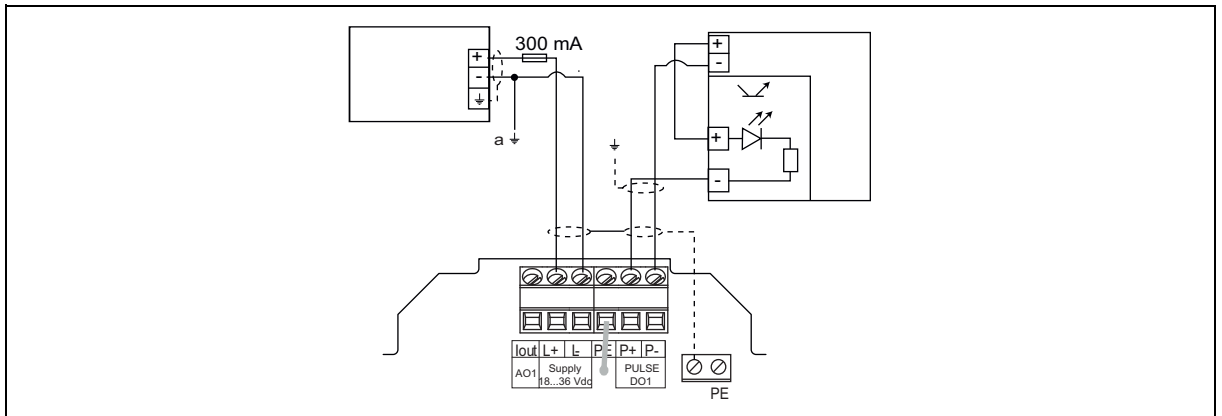

- a If direct grounding is not possible, connect a capacitor with 100 nF/50 V between the voltage supply's negative terminal and the ground.

## 7.3.7 Connecting the relay outputs DO2 and DO3

### Possible connection options for the relay outputs DO2 and DO3

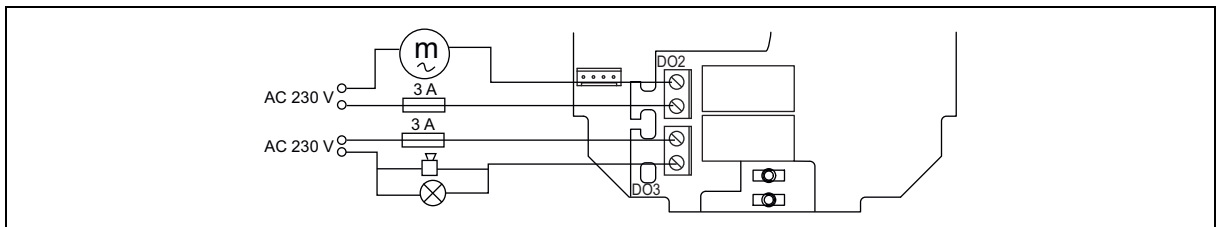

### 8.1 Safety information



**Risk of injury due to improper operation!**

Failing to operate the device correctly can lead to injury, and damage to the device and its surroundings.

The device/system must always be operated by staff with a sufficient level of training.

Make sure that the operating staff are familiar with and understand the contents of the operating manual.

Any safety information and notes on proper use are particularly important.

---



**NOTE!**

Before putting the sensor into operation for the first time, immerse it into the measuring material for 24 hours.

---

## 8 Startup and parameterization

### 8.2 Operating levels

The device's operating levels consist of a process level and configuration level.

Level	Functions
Process level	Extracting the flow rate measured by the device, the current value emitted at the 4 to 20 mA current output, and the values for the main counter and daily counter
	Extracting the daily counter
	Switching to the configuration level
Configuration level with parameterization, testing, and information menu	Adjusting the device's parameters
	Testing certain device parameters
	Calibrating the device
	Extracting any warnings or error messages generated by the device if the device status LED is orange or red

Function	Basic setting
LANGUAGE	English
UNIT of the flow rate	l/min.
UNIT for the counter	Liters
K-FACTOR	1000
OUTPUT AO1	4 mA = 0.000
	20 mA = 0.000
OUTPUT DO1	Pulse
	PU = 0.00 liters
OUTPUT DO2	Hysteresis
	2- = 0.000
	2+ = 0.000
	Not inverted
OUTPUT DO3	Delay = 0
	Hysteresis
	3- = 0.000
	3+ = 0.000
INPUT DI1	Not inverted
	Delay = 0
	Hysteresis
	3- = 0.000
FILTER	5, slow
FREQUENC.	50 Hz
CUT-OFF	0.000
BACKLIT	Filter 9, activation period: 30 s
K-SENSOR	KW = 1.000
FLOW-W.	W- = 0.000
	W+ = 0.000



# 8 Startup and parameterization

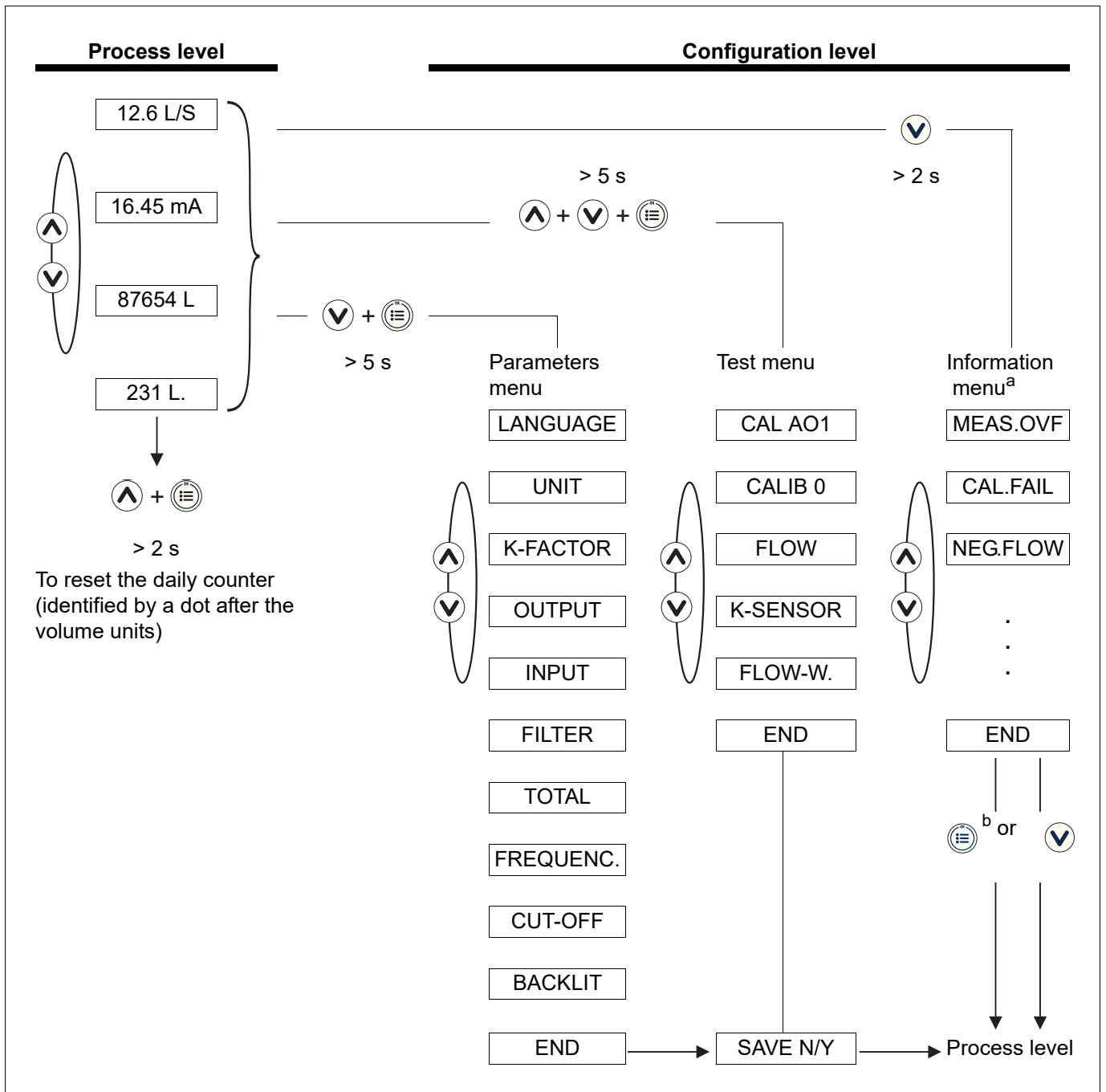

<sup>a</sup> Only accessible when the device status is orange or red (⇒ see chapter 8.3 "Display, navigation keys and status LEDs", page 34).



<sup>b</sup> When the CONFIRM key is unlocked

## 8 Startup and parameterization

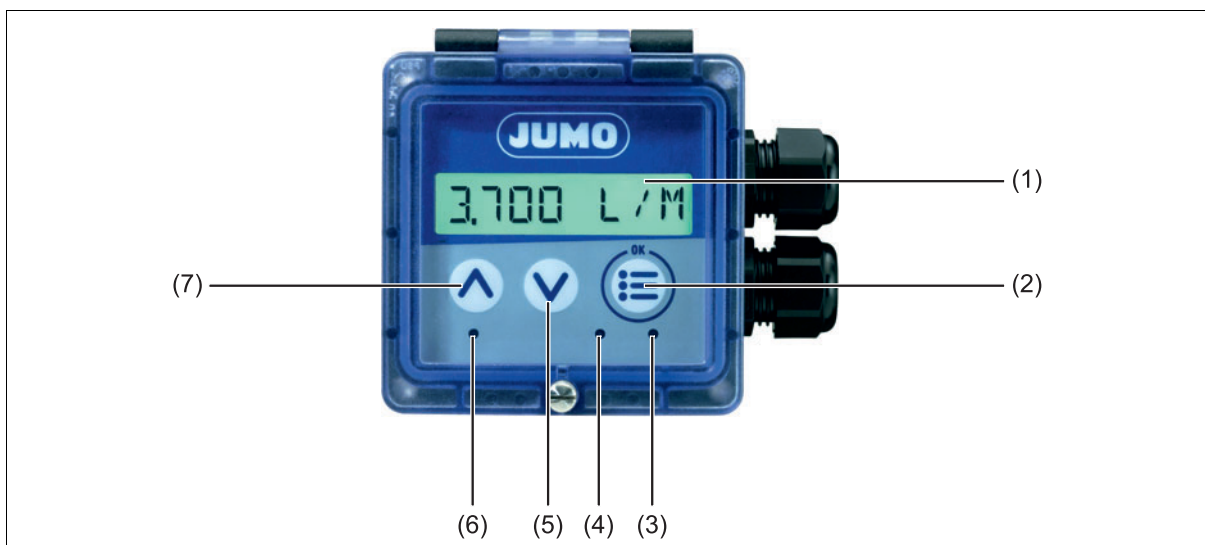















### 8.3 Display, navigation keys and status LEDs



- (1) Digital display with eight digits (four numeric, four alphanumeric)
- (2) CONFIRM key: To select the displayed function, to confirm settings
- (3) Status LED for the relay DO3 (LED on = Contact closed)
- (4) Status LED for the relay DO2 (LED on = Contact closed)
- (5) To read messages, to scroll down through the functions, to select the digit on the left
- (6) Device status LED ⇒ see table below
- (7) To scroll up through the functions, to increase the selected digit

Device status LED	Device status
Green	The device is working without any faults.
Orange	A warning message has been generated. Press the  key in the process level for two seconds to read the message (⇒ see chapter 9.5.5 "Solving a problem with a warning or error message with the orange device status LED", page 80). Otherwise, the relay output DO2 or DO3 or the transistor output DO1 will switch if it is configured for "WARNING" mode (⇒ see chapter 8.6.10 "Configuring the transistor output DO1 to switch a load when the device generates a warning", page 51 or "Configuring the relay outputs DO2 and DO3 to switch a load when the device generates a warning ", page 54).
Red	An error message has been generated and the current output emits 22 mA. Press the  key in the process level for two seconds to read the message (⇒ see chapter 9.5.4 "Solving a problem with a warning or error message with the red device status LED", page 79).
Flashing, regardless of the color	The digital input DI1 is active or The checking function for proper output response is active (⇒ see chapter 8.7.3 "Checking proper response of the outputs", page 70) or Calibration of the zero flow rate is active (⇒ see chapter 8.7.2 "Calibrate the flow rate zero point", page 67) or The daily counter is locked at zero.

### 8.4 Using the navigation keys

You can...	Button functions
Move between the functions in a level or menu	Next function:  Previous function: 
Display the parameters menu	 +  at the same time for 5 seconds in the process level
Display the test menu	 +  +  at the same time for 5 seconds in the process level
Display the information menu	 for 2 seconds in the process level if the device status LED is orange or red
Reset the daily counter	 +  at the same time for 2 seconds if the daily counter is displayed in the process level
Select the displayed function	
Confirm the displayed value	
Change a numerical value	 to increase the selected digit  to select the previous digit  +  to move the comma

# 8 Startup and parameterization

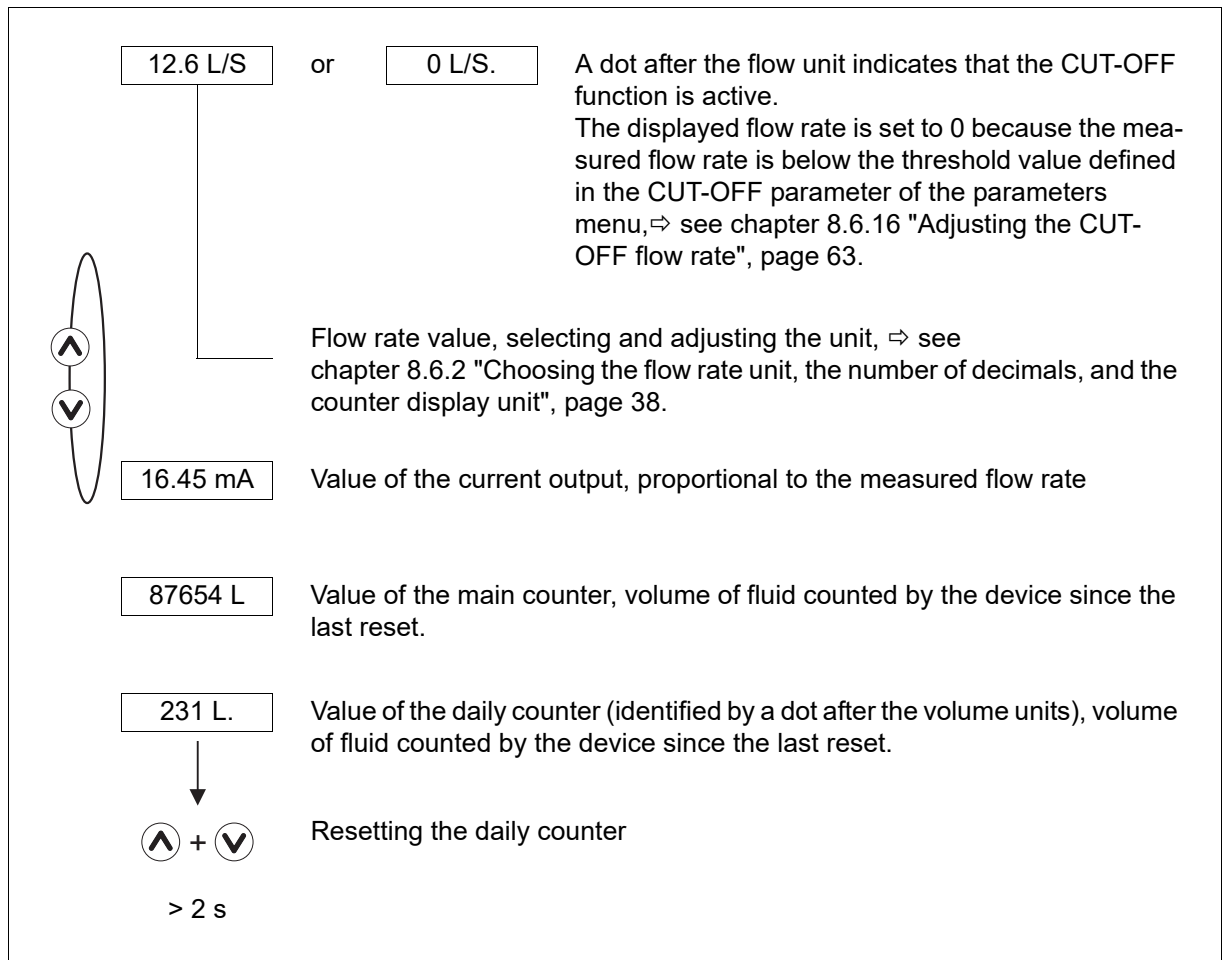

## 8.5 Process level details

This level is active when the device is switched on.



# 8 Startup and parameterization

## 8.6 Parameter menu details

1. In order to access the parameters menu, press the  +  keys at the same time for more than 5 seconds.

This menu allows you to adjust the following device parameters:

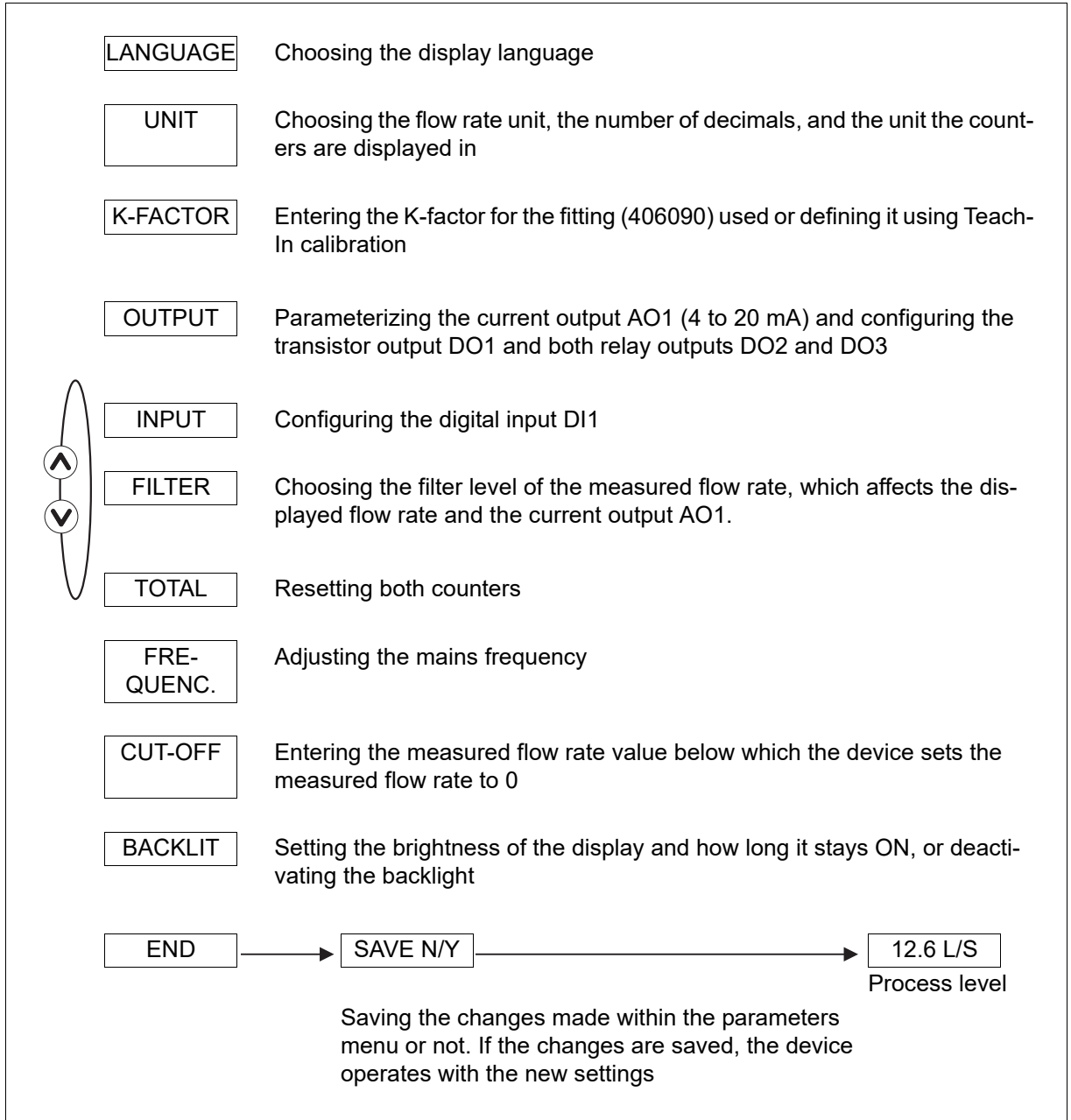

# 8 Startup and parameterization

## 8.6.1 Choosing the display language.

The menu is in English when switched on.

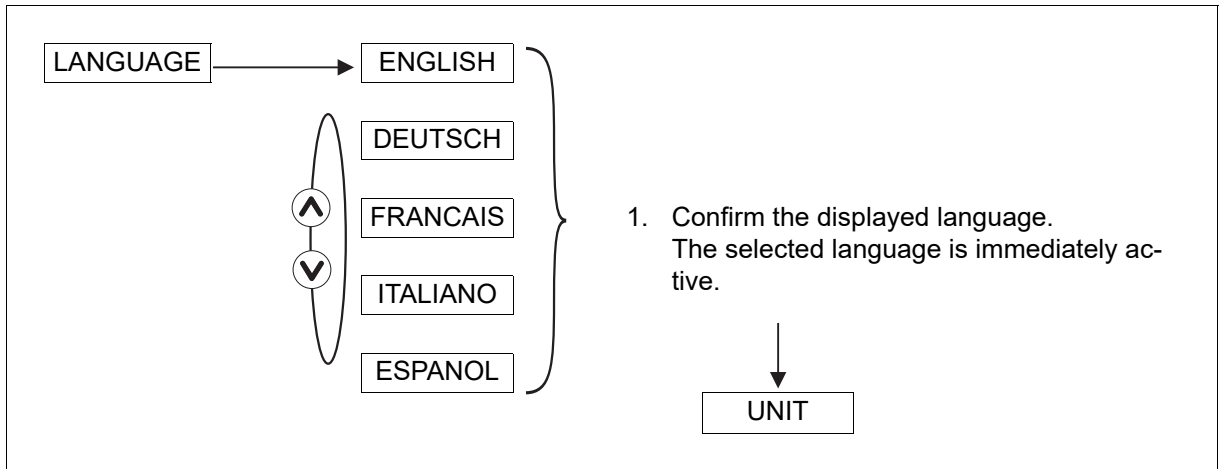

1. If you do not wish to change any further parameters, go to the END function in the parameters menu and press the  key in order to save the settings and return to the process level.

## 8.6.2 Choosing the flow rate unit, the number of decimals, and the counter display unit



### NOTE!

Only the counters are automatically converted when the flow rate unit is adjusted.  
Convert any other flow rate settings manually if necessary.



### NOTE!

The maximum flow value that can be displayed depends on the decimal places selected:

- 9999 if decimal places = 0 or AUTO
- 999.9 if decimal places = 1
- 99.99 if decimal places = 2
- 9.999 if decimal places = 3

The UNIT function enables you to select the following:

- Flow rate unit
- Fixed point (selection 0, 1, 2 or 3) to display the flow rate value in the process level or a sliding point (selection AUTO): In this case, the device selects the position of the decimal point depending on the unit selected and the flow rate value measured
- Counters' volume unit if the flow rate unit selected above is liters or m<sup>3</sup>

## 8 Startup and parameterization

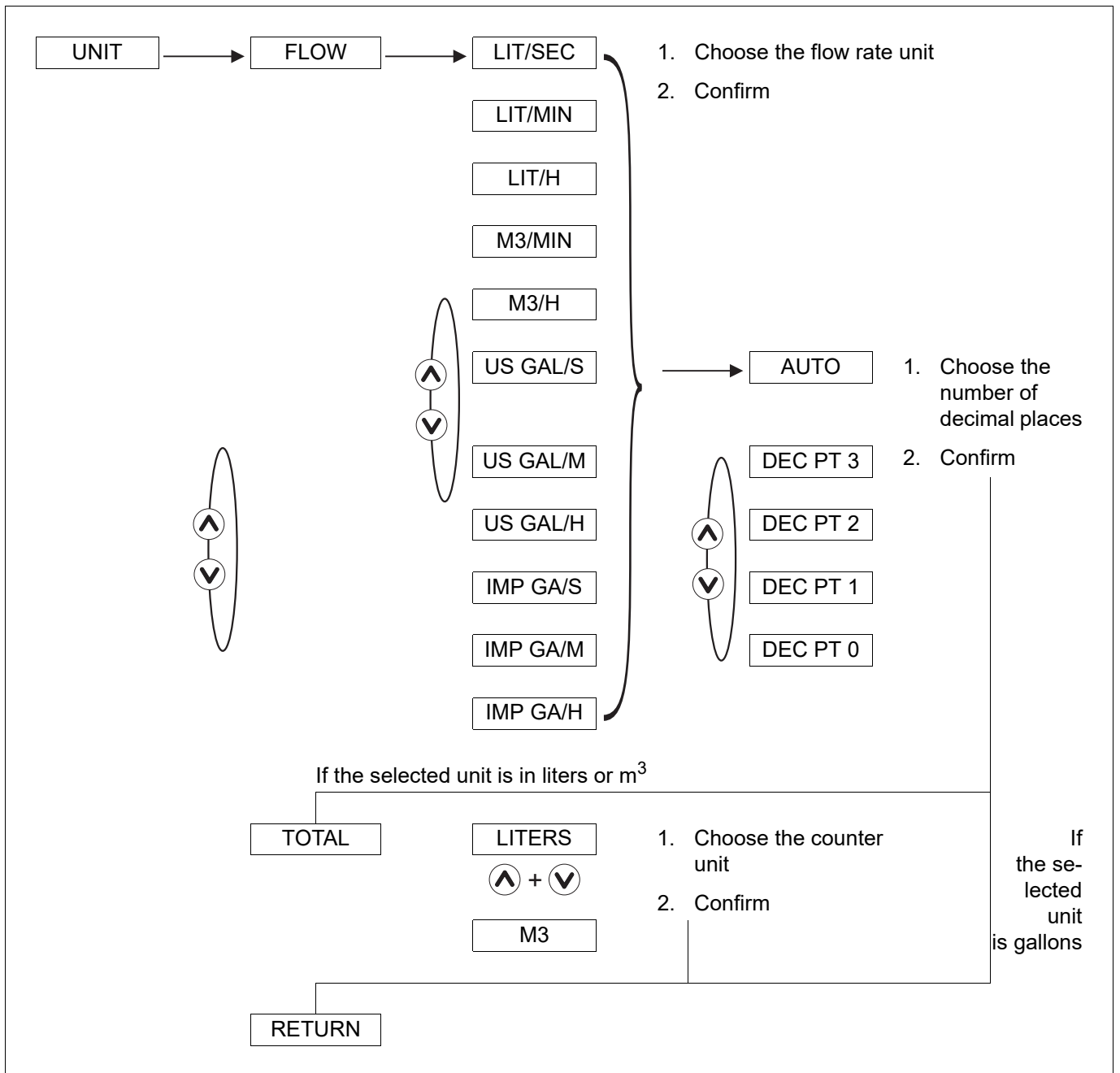

1. If you do not wish to change any further parameters, go to the END function in the parameters menu and press the  key in order to save the settings and return to the process level.

## 8 Startup and parameterization

### 8.6.3 Entering the K-factor for the fitting (406090) used

The device calculates the medium's flow rate in the pipeline with the K-factor for the fitting (406090) used.

You can enter the K-factor for the fitting used here. The device can also determine the K-factor in a calibration procedure (Teach-In), ⇒ see chapter 8.6.4 "Determining the fitting's K-factor with a calibration procedure (Teach-In)", page 41.



#### NOTE!

The device starts using the new K-factor as soon as the function SAVE YES is confirmed when leaving the parameters menu.

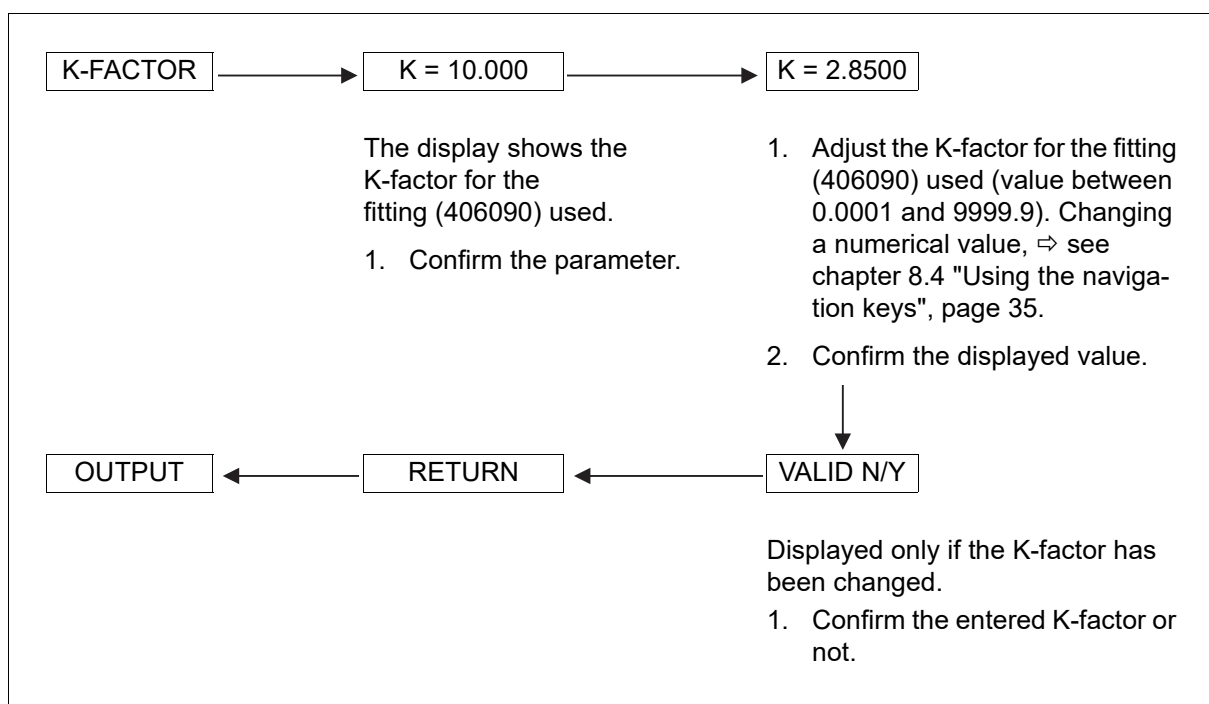

1. If you do not wish to change any further parameters, go to the END function in the parameters menu and press the  key in order to save the settings and return to the process level.



### 8.6.4 Determining the fitting's K-factor with a calibration procedure (Teach-In)



**NOTE!**

Prior to Teach-In:

Calibrate the flow rate zero point (⇒ see chapter 8.7.2 "Calibrate the flow rate zero point", page 67).

Check that the KW value for the sensor has not been changed (⇒ see chapter 8.7.4 "Changing the sensor's KW value", page 70).

---

The device calculates the medium's flow rate in the pipeline with the K-factor for the fitting used.

The function TEACH V. or TEACH F. is a calibration process (Teach-In) for determining the fitting's K-factor. The K-factor can also be entered, ⇒ see chapter 8.6.3 "Entering the K-factor for the fitting (406090) used", page 40.

The calibration procedure is applied either in relation to a known volume (TEACH V.) or in relation to the current flow rate (TEACH F.), as measured with a reference instrument.

# 8 Startup and parameterization

## Determining the fitting's K-factor with a Teach-In process in relation to a volume (TEACH V.)



**NOTE!**

The device starts using the new K-factor as soon as the function SAVE YES is confirmed when leaving the parameters menu.

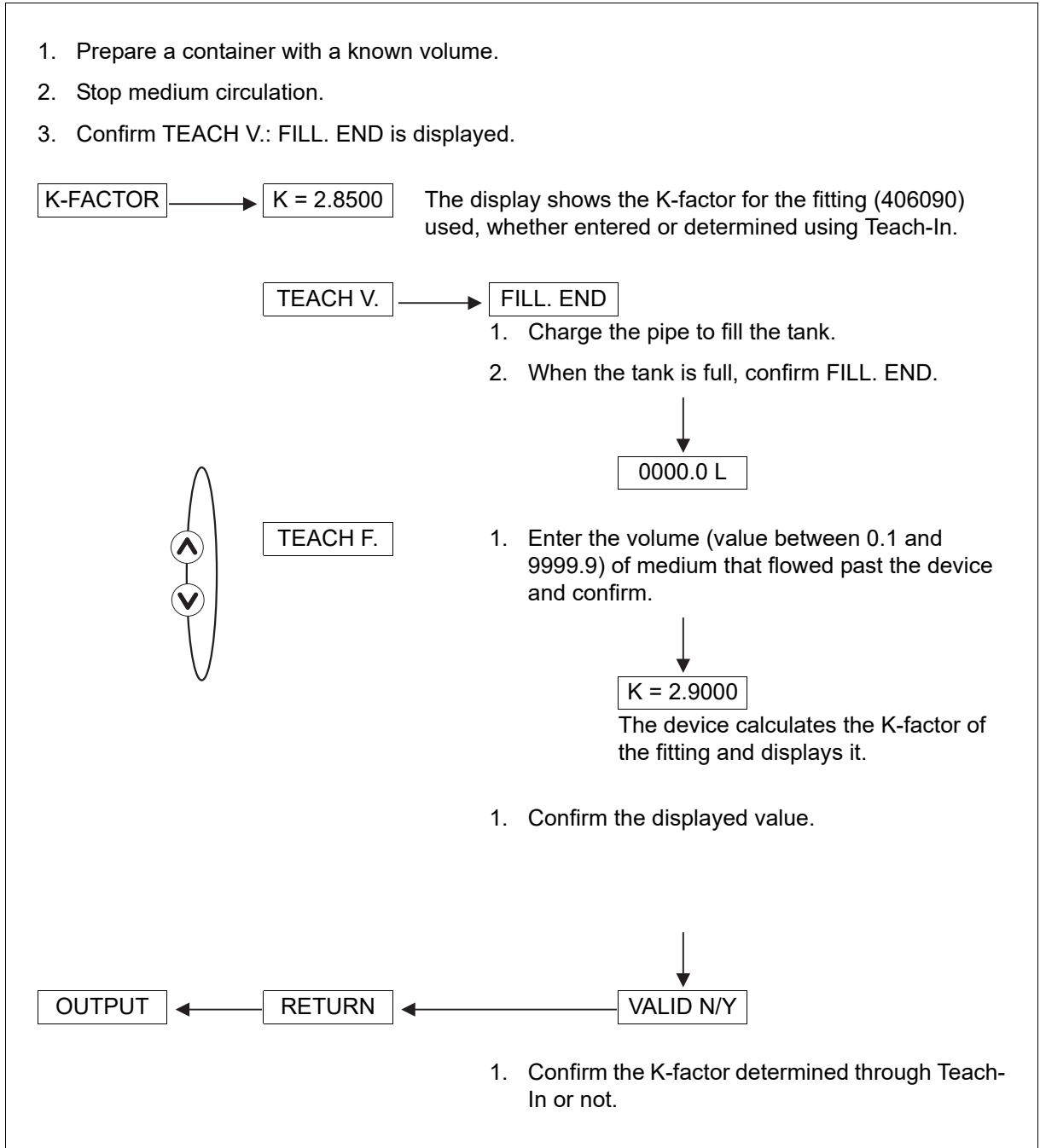

1. If you do not wish to change any further parameters, go to the END function in the parameters menu and press the  key in order to save the settings and return to the process level.

# 8 Startup and parameterization

## Determining the fitting's K-factor with a Teach-In process in relation to a flow rate (TEACH F.)



### NOTE!

The device starts using the new K-factor as soon as the function SAVE YES is confirmed when leaving the parameters menu.

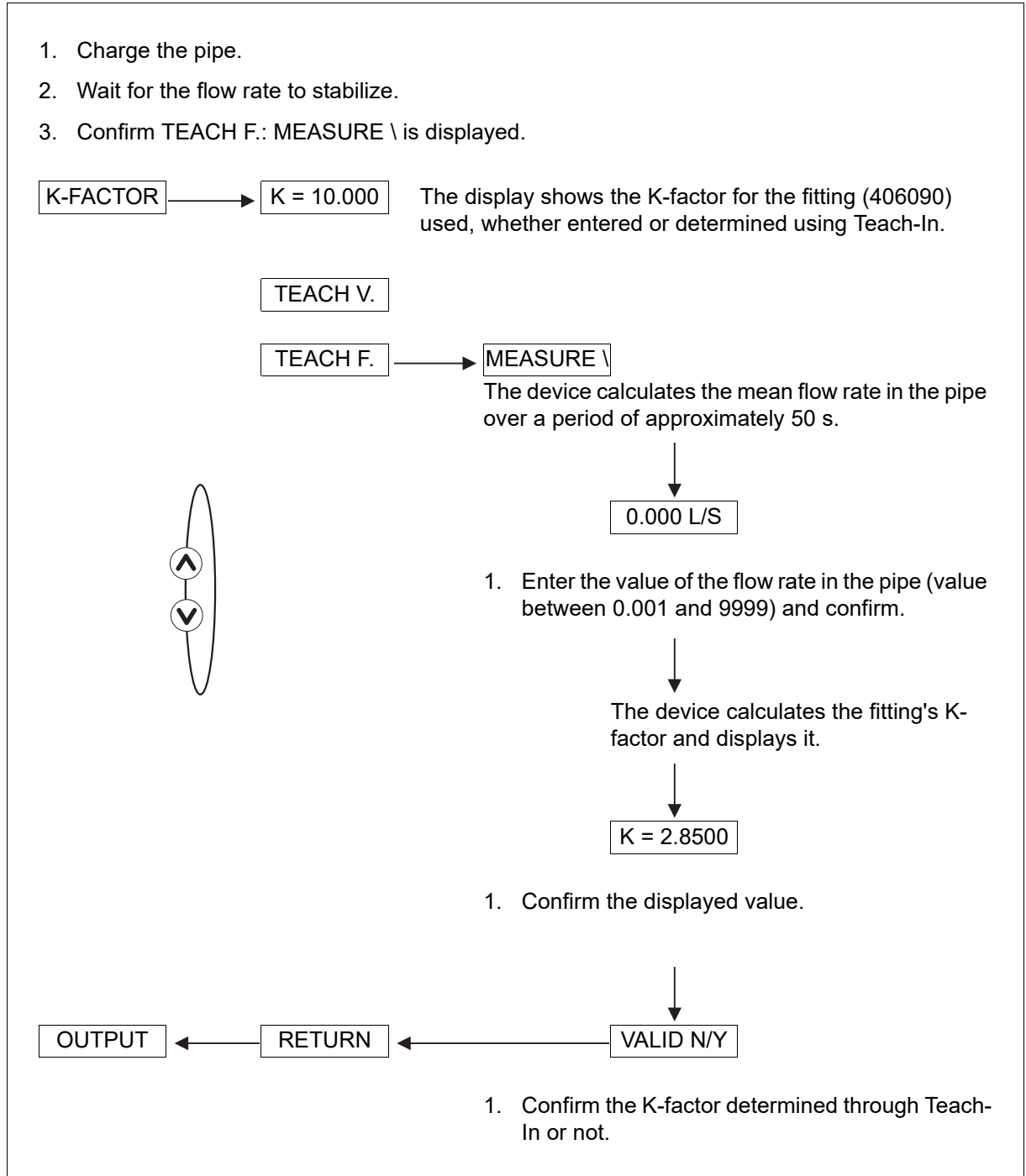

1. If you do not wish to change any further parameters, go to the END function in the parameters menu and press the  key in order to save the settings and return to the process level.

# 8 Startup and parameterization

## 8.6.5 Configuring outputs

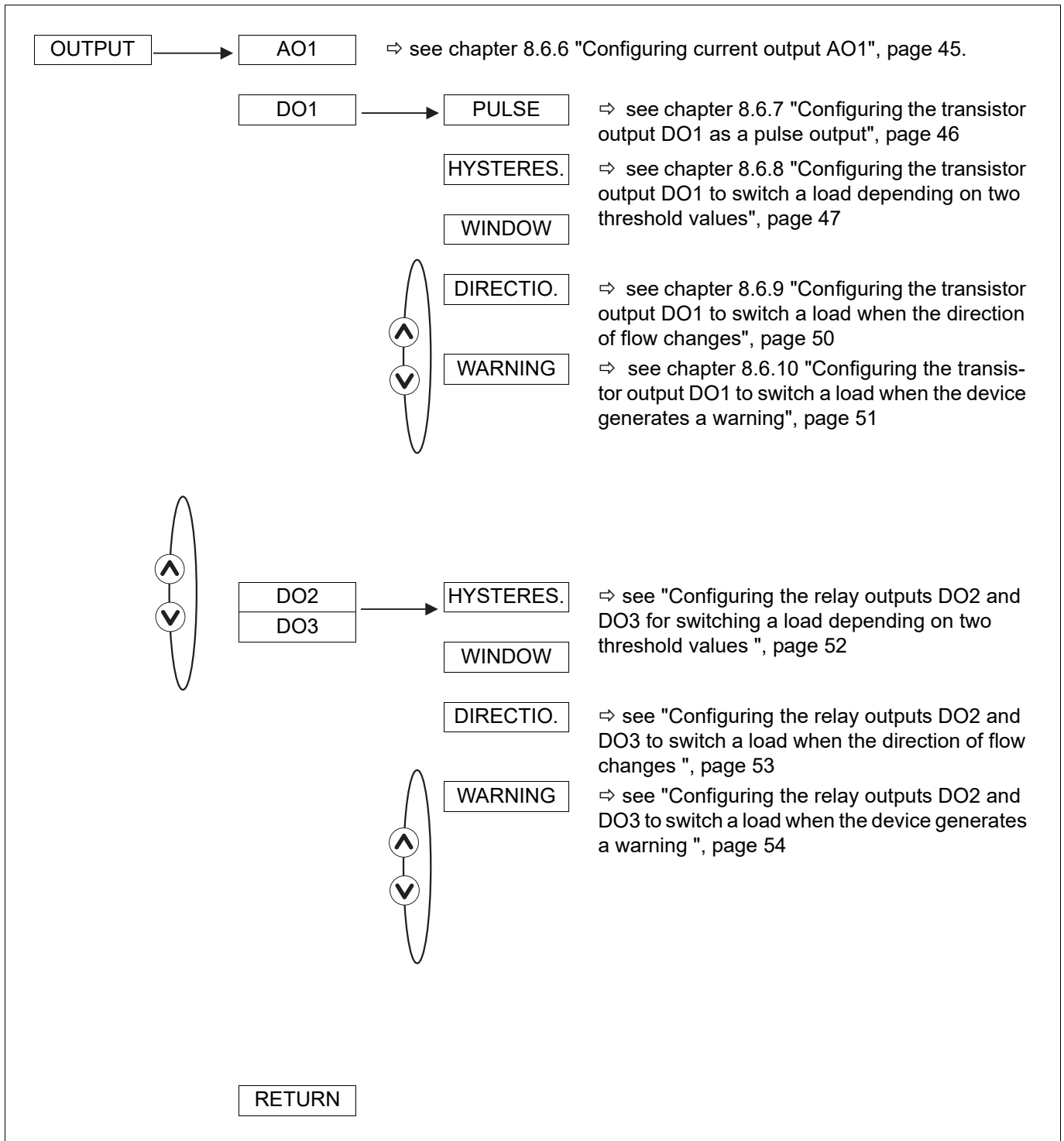

# 8 Startup and parameterization

## 8.6.6 Configuring current output AO1



### NOTE!

The current output AO1 emits a 22 mA-signal when the device emits an error, even if the output is deactivated.

The current output AO1 (4 to 20 mA) emits a signal, the value of which represents the flow rate measured by the device.

### Example:

Current output signal (4 to 20 mA) in relation to the measuring range:

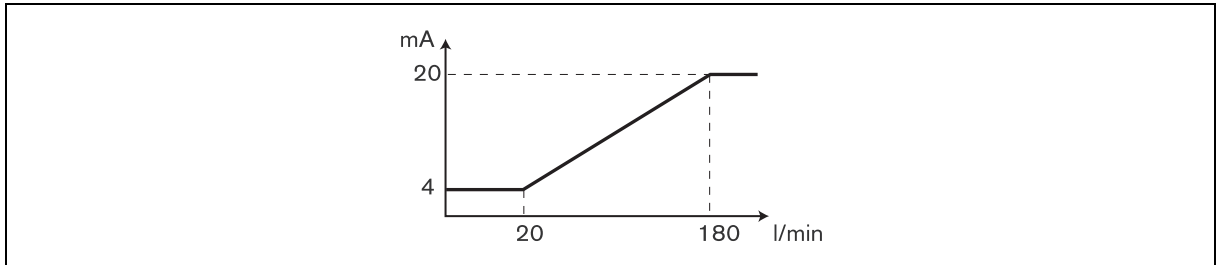

1. To invert the output signal, enter a flow rate value lower than the 4 mA value for the 20 mA value.
2. To deactivate the output, set the 4 mA and 20 mA limits to zero. In this case, the current output emits a constant signal of 4 mA.



### NOTE!

The units of the displayed values and the values to be entered manually correspond to the values selected in chapter 8.6.2 "Choosing the flow rate unit, the number of decimals, and the counter display unit", page 38.

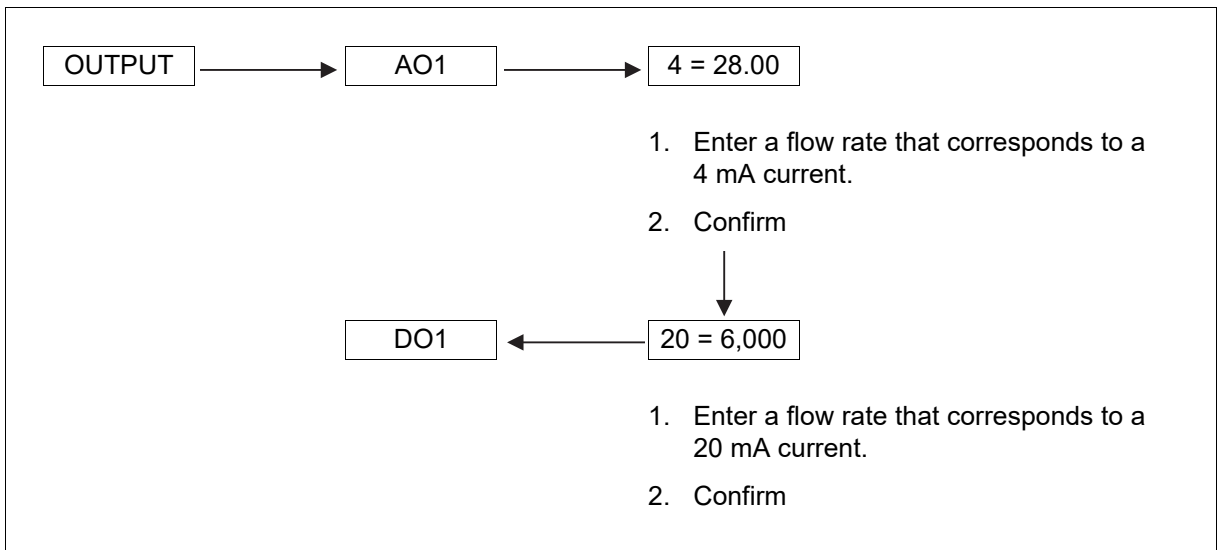

# 8 Startup and parameterization

## 8.6.7 Configuring the transistor output DO1 as a pulse output

If the transistor output DO1 is configured as a pulse output, a pulse is generated at this output each time a selected medium volume is reached.



**NOTE!**

The units of the displayed values and the values to be entered manually correspond to the values selected in chapter 8.6.2 "Choosing the flow rate unit, the number of decimals, and the counter display unit", page 38.

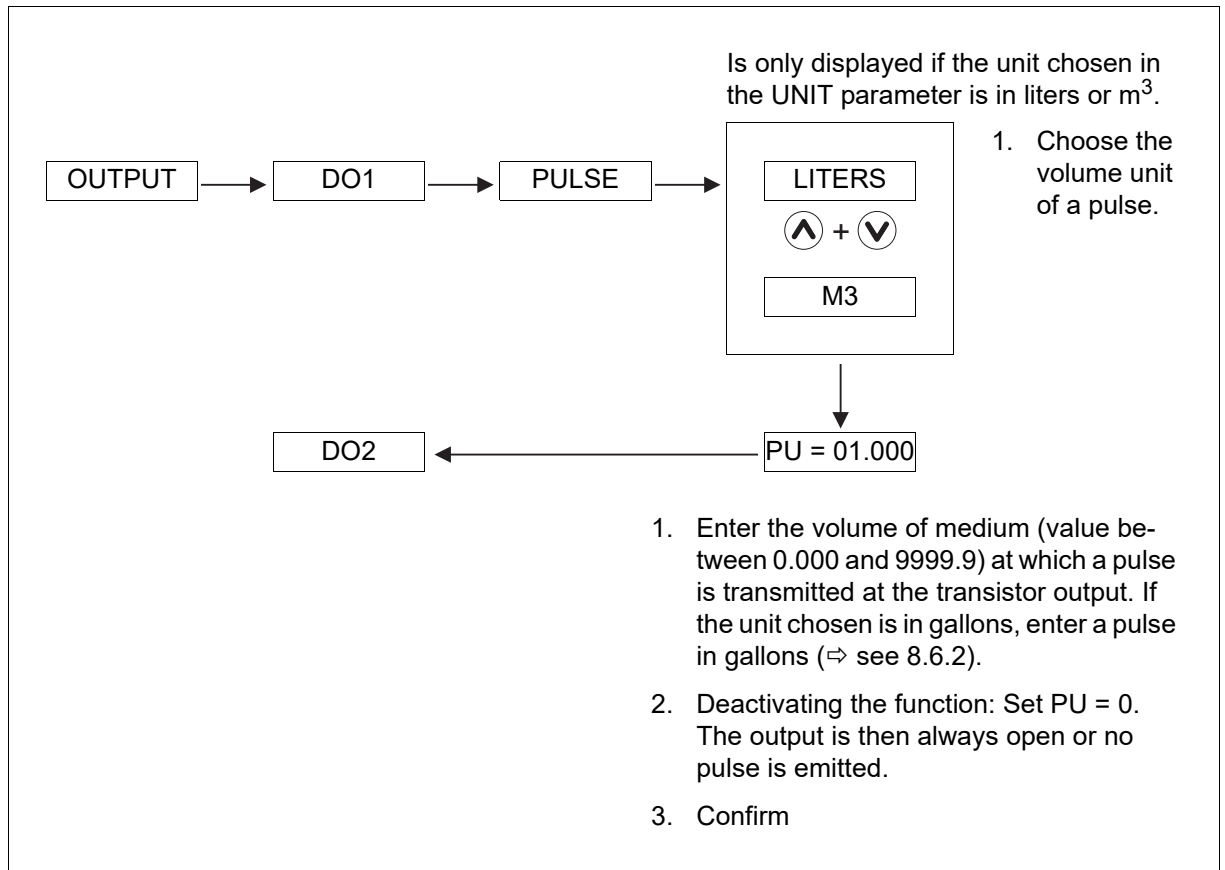

# 8 Startup and parameterization

## 8.6.8 Configuring the transistor output DO1 to switch a load depending on two threshold values



### NOTE!

The units of the displayed values and the values to be entered manually correspond to the values selected in chapter 8.6.2 "Choosing the flow rate unit, the number of decimals, and the counter display unit", page 38.

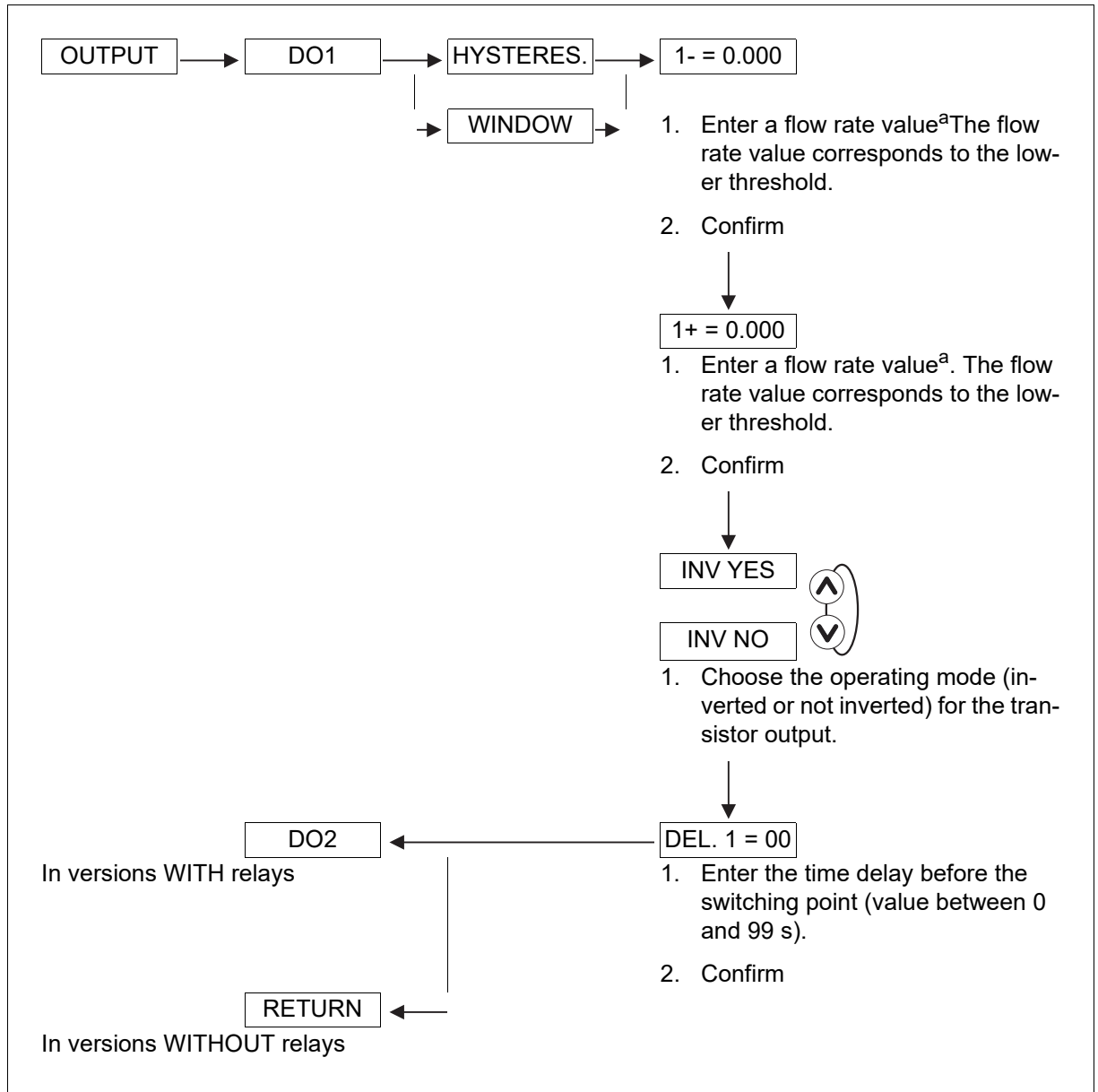

<sup>a</sup> In hysteresis mode: Value for 2- ≤ 2+ or 3- ≤ 3+.  
In window mode: Value for 2- < 2+ or 3- < 3+.

## 8 Startup and parameterization

### Hysteresis mode

The output switches when a threshold is reached:

- When the flow rate increases, the output status changes when the high threshold  $X+$  is reached.
- When the flow rate decreases, the output status changes when the low threshold  $X-$  is reached.

Not inverted

Contact

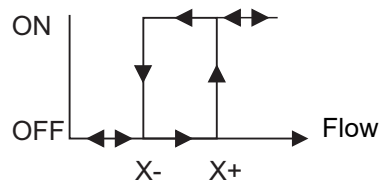

Inverted

Contact

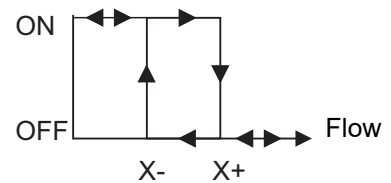

$X-$  = Low switching threshold of the transistor or the relay (1-, 2- or 3-)

$X+$  = High switching threshold of the transistor or the relay (1+, 2+ or 3+)

### Window mode

The status changes as soon as any threshold ( $X-$  or  $X+$ ) is reached.

Not inverted

Contact

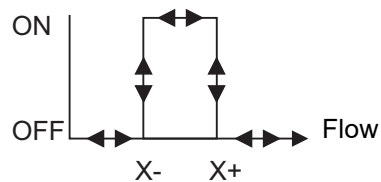

Inverted

Contact

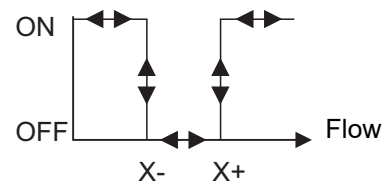

$X-$  = Low switching threshold of the transistor or the relay (1-, 2- or 3-)

$X+$  = High switching threshold of the transistor or the relay (1+, 2+ or 3+)



# 8 Startup and parameterization

Example of operating the transistor output DO1 with switching thresholds

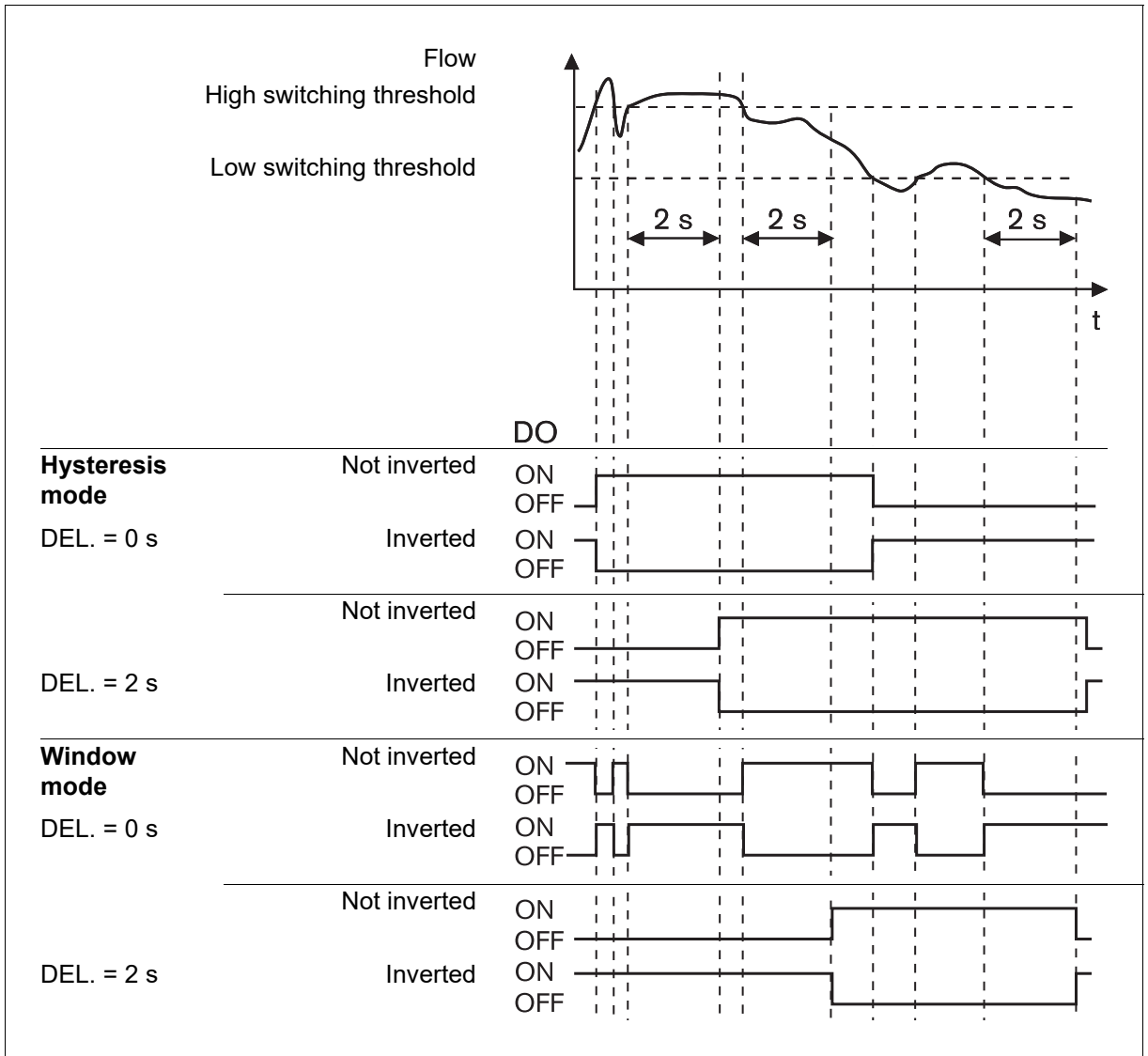

# 8 Startup and parameterization

## 8.6.9 Configuring the transistor output DO1 to switch a load when the direction of flow changes



**NOTE!**

If the measured flow rate is in the range of the CUT-OFF flow rate (⇒ see chapter 8.6.16 "Adjusting the CUT-OFF flow rate", page 63), the flow rate is regarded as zero and positive. The following diagram shows how the DO output responds when it is configured to report a change in flow direction and when the CUT-OFF function is used.

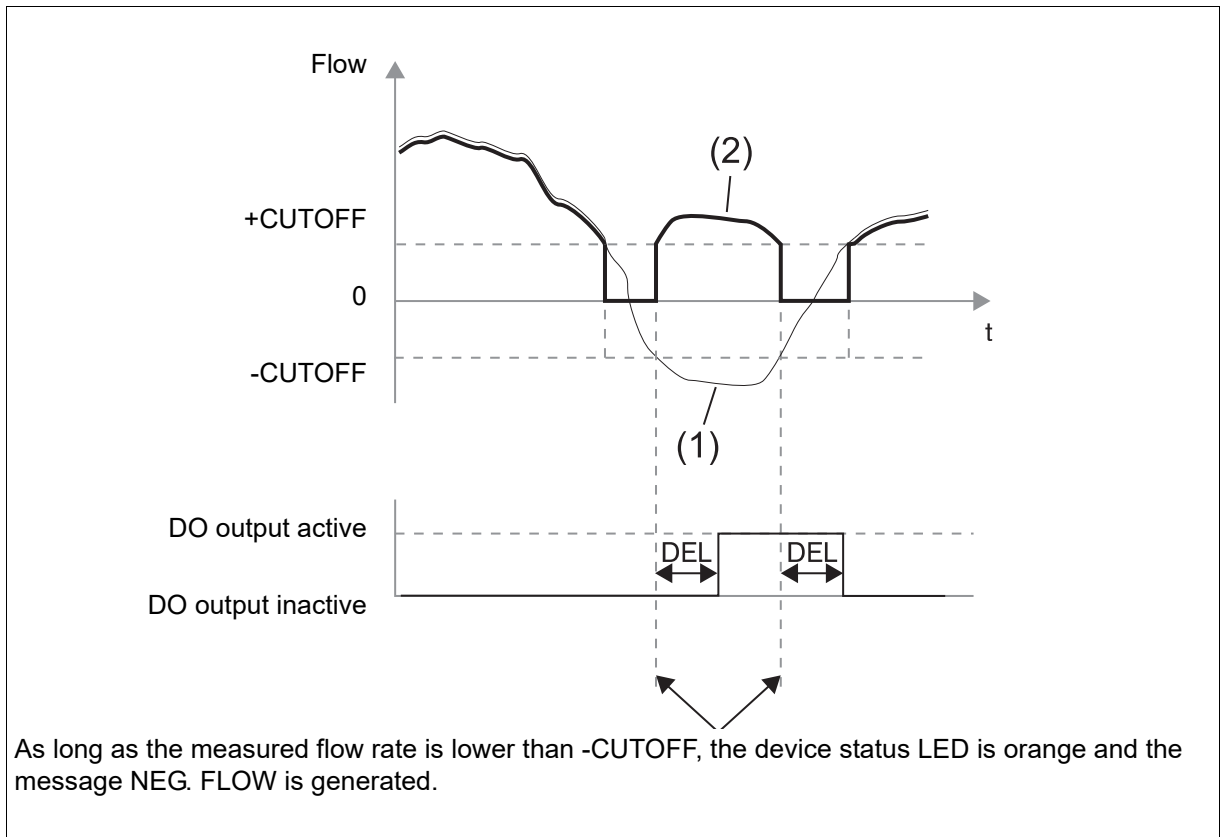

(1) Measured flow rate

(2) Displayed flow rate

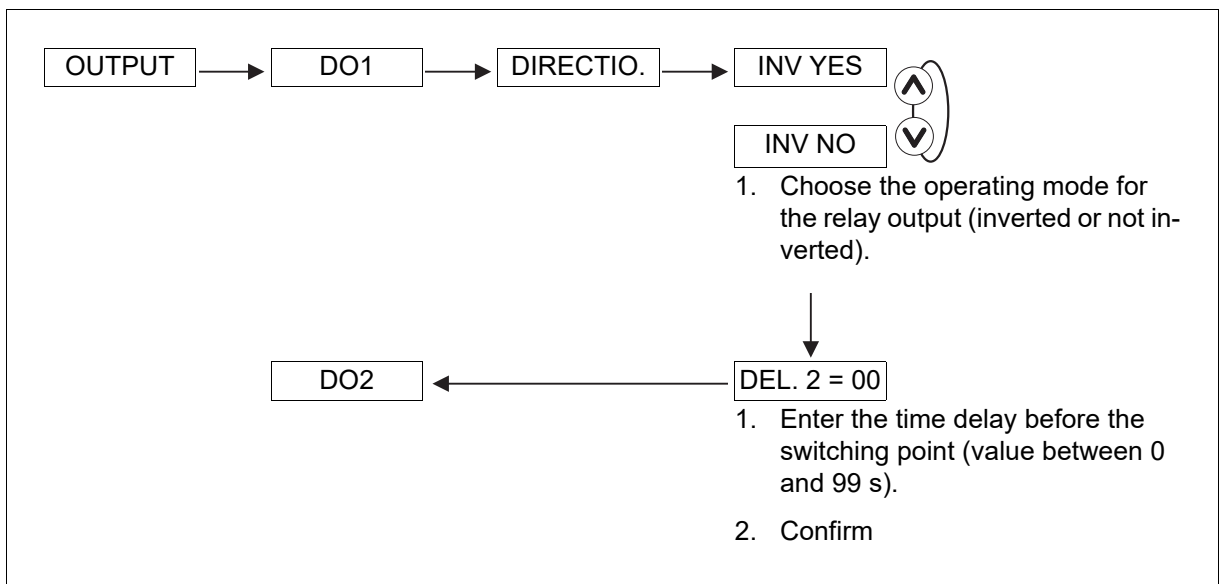

## 8 Startup and parameterization

### 8.6.10 Configuring the transistor output DO1 to switch a load when the device generates a warning

When the device generates a warning message, the device status LED is orange.

The generation of a warning message can also be indicated by the switching of the transistor output DO1.



#### NOTE!

The units of the displayed values and the values to be entered manually correspond to the values selected in chapter 8.6.2 "Choosing the flow rate unit, the number of decimals, and the counter display unit", page 38.

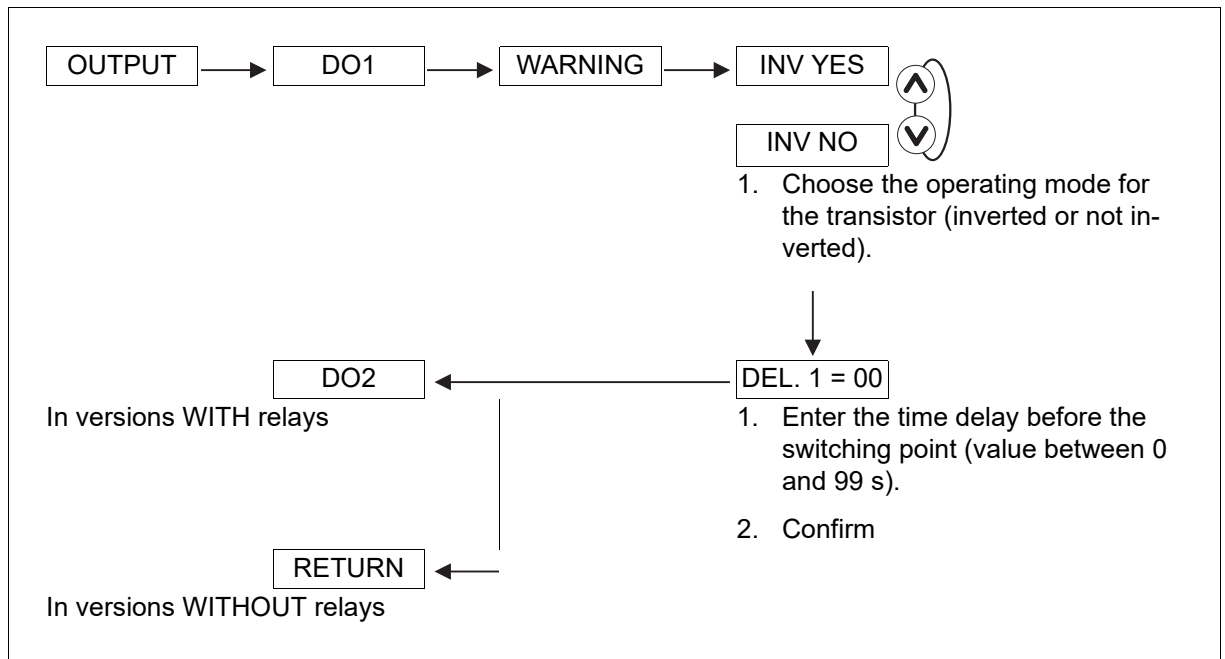

# 8 Startup and parameterization

## 8.6.11 Configuring the relay outputs DO2 and DO3



**NOTE!**

The units of the displayed values and the values to be entered manually correspond to the values selected in chapter 8.6.2 "Choosing the flow rate unit, the number of decimals, and the counter display unit", page 38.

### Configuring the relay outputs DO2 and DO3 for switching a load depending on two threshold values

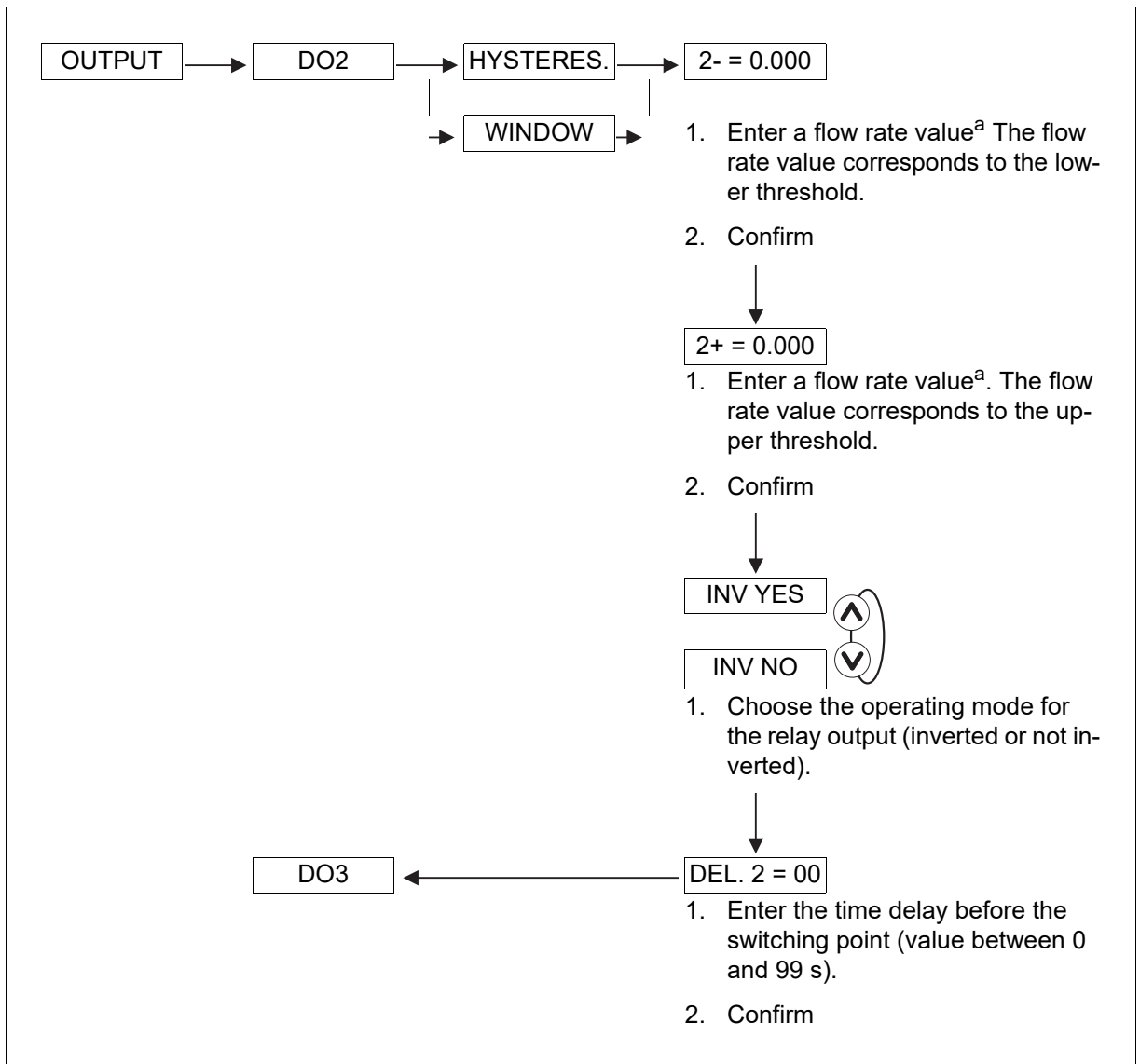

<sup>a</sup> In hysteresis mode: Value for  $2- \leq 2+$  or  $3- \leq 3+$ .  
In window mode: Value for  $2- < 2+$  or  $3- < 3+$ .



**NOTE!**

⇒ See also chapter 8.6.8 "Configuring the transistor output DO1 to switch a load depending on two threshold values", page 47

# 8 Startup and parameterization

## Configuring the relay outputs DO2 and DO3 to switch a load when the direction of flow changes



**NOTE!**

If the measured flow rate is in the range of the CUT-OFF flow rate (⇒ see chapter 8.6.16 "Adjusting the CUT-OFF flow rate", page 63), the flow rate is regarded as zero and positive. The following diagram shows how the DO output responds when it is configured to report a change in flow direction and when the CUT-OFF function is used.

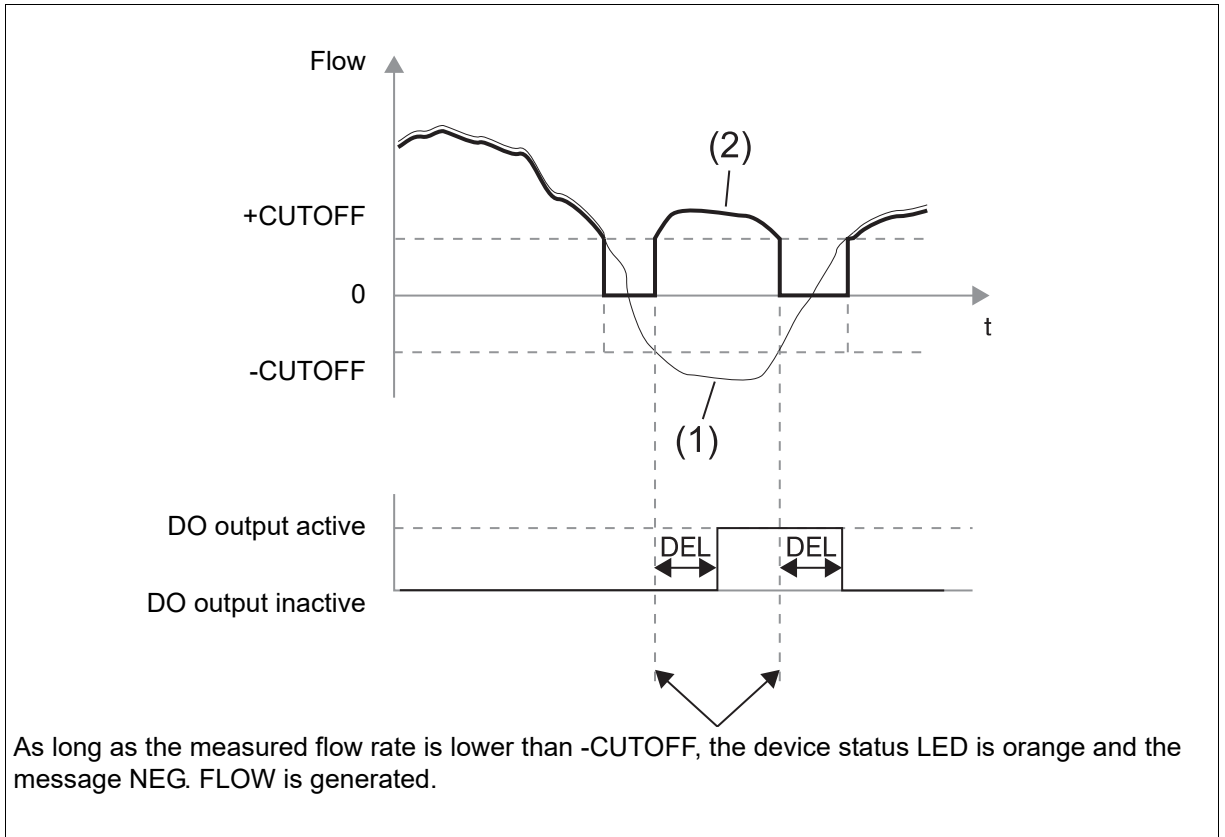

(1) Measured flow rate

(2) Displayed flow rate

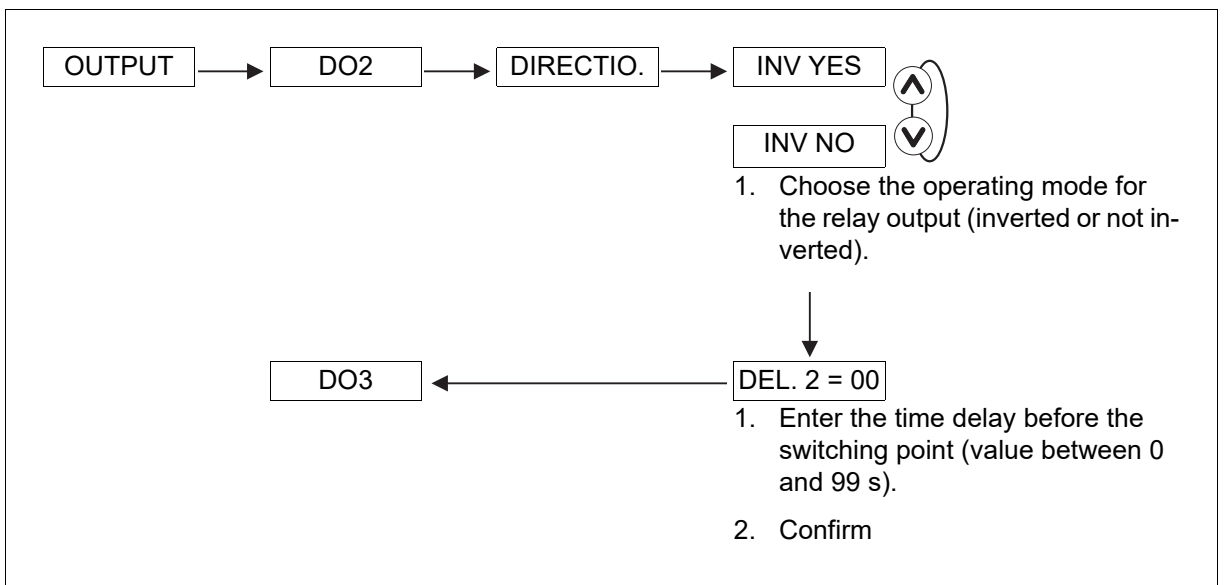



## 8 Startup and parameterization

### Configuring the relay outputs DO2 and DO3 to switch a load when the device generates a warning

When the device generates a warning message, the device status LED is orange.

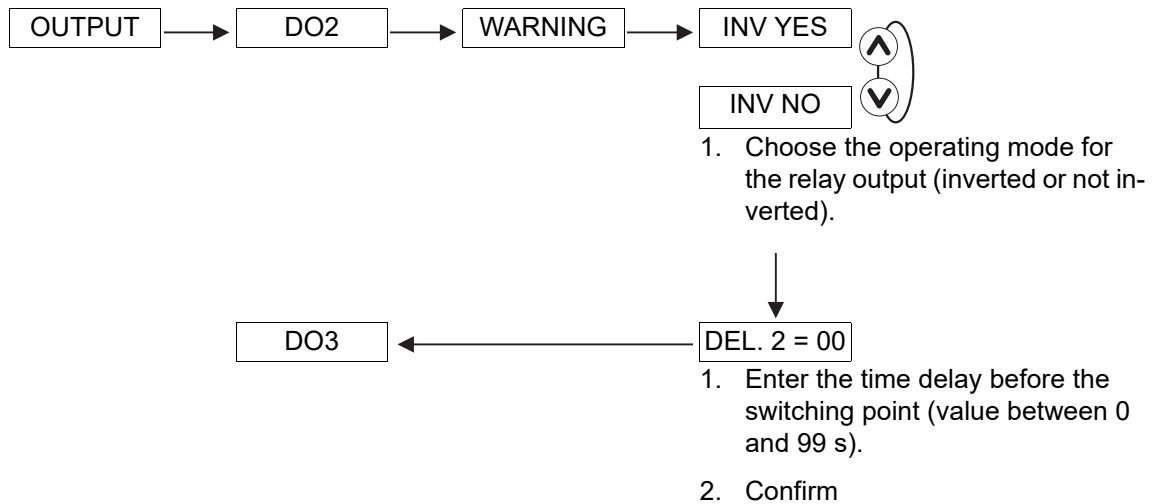
The generation of a warning message can also be indicated by the switching of the transistor output.



1. If you do not wish to change any further parameters, go to the END function in the parameters menu and press the  key in order to save the settings and return to the process level.

## 8 Startup and parameterization

### 8.6.12 Configuring the digital input DI1

The digital input DI1 allows one of the four following functions to be triggered remotely:

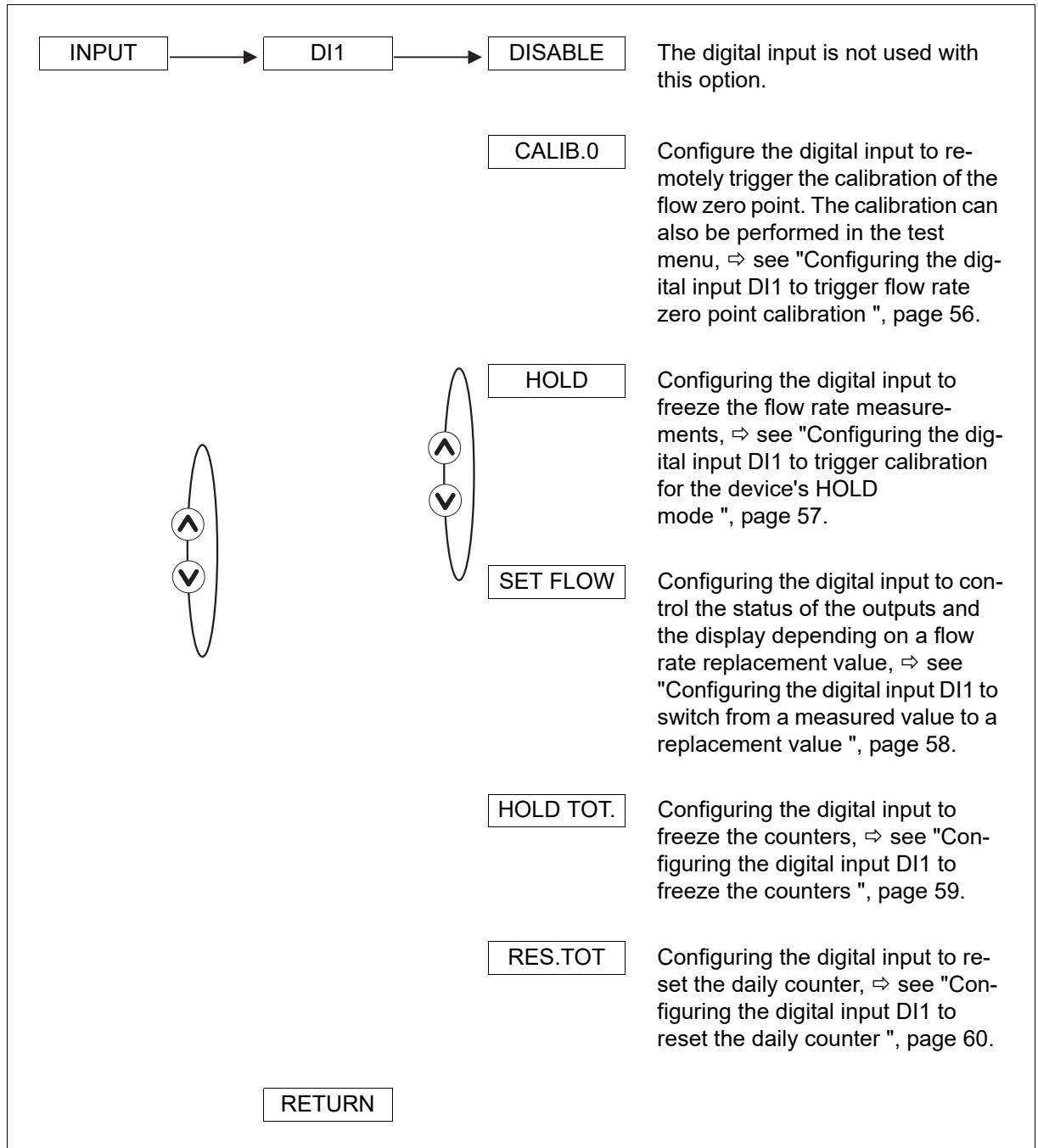

# 8 Startup and parameterization

## Configuring the digital input DI1 to trigger flow rate zero point calibration



**NOTE!**

Calibrating the flow rate zero point, ⇒ see chapter 8.7.2 "Calibrate the flow rate zero point", page 67

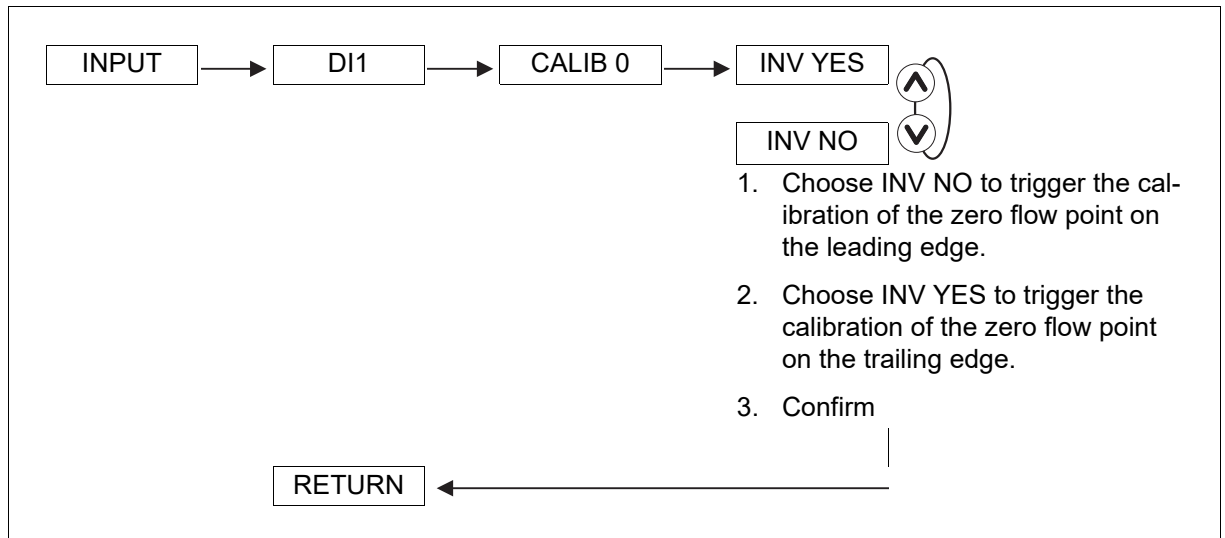



## Configuring the digital input DI1 to trigger calibration for the device's HOLD mode



### NOTE!

Triggering of HOLD mode is ignored if the checking function for proper output response is active (⇒ see chapter 8.7.3 "Checking proper response of the outputs", page 70).

The HOLD mode is used to carry out maintenance work without interrupting the process.

In practice, when the device is in HOLD mode:

- The device status LED flashes.
- The current transmitted at the 4 to 20 mA output is frozen to the value of the last measured flow rate.
- The displayed flow rate is frozen to the value of the last measured flow rate.
- Each relay or transistor output is frozen to the status it had when Hold mode was activated.
- The counters do not increment any more (frozen).
- The device remains in Hold mode until the digital input switches again.

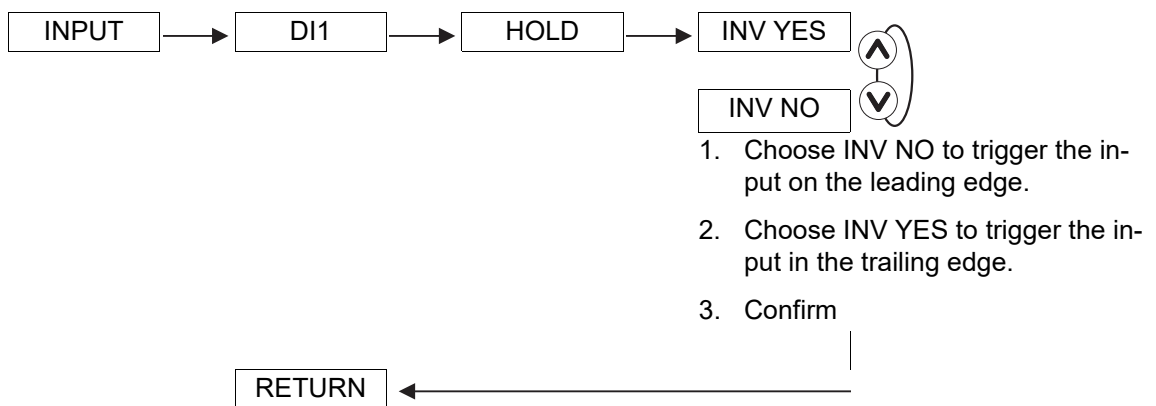

# 8 Startup and parameterization

## Configuring the digital input DI1 to switch from a measured value to a replacement value



**NOTE!**

The replacement value is ignored if the checking function for proper output response is active (⇒ see chapter 8.7.3 "Checking proper response of the outputs", page 70).



**NOTE!**

The units of the displayed values and the values to be entered manually correspond to the values selected in chapter 8.6.2 "Choosing the flow rate unit, the number of decimals, and the counter display unit", page 38.

This function enables a replacement value specified by the user to be emitted instead of the measured value.

When the digital input is activated:

- The device status LED flashes.
- The signal transmitted at the 4 to 20 mA output is set to the replacement value.
- The displayed flow rate is set to the replacement value.
- Each transistor or relay output adopts the status depending on the replacement value.
- The counters do not increment any more.
- The replacement flow rate is active until the digital input switches again.

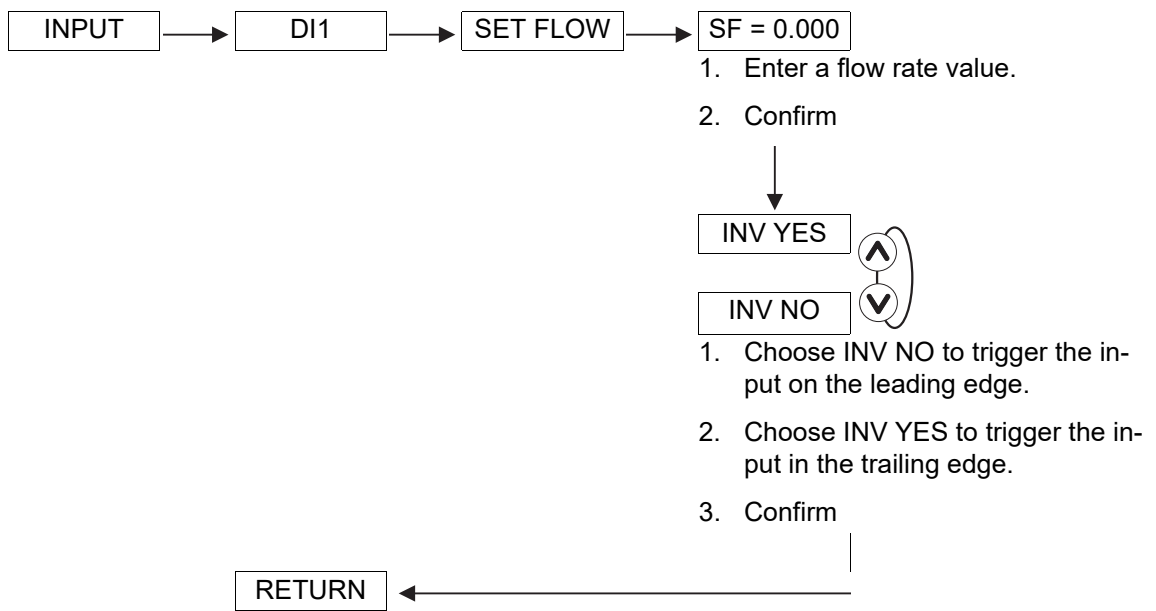

## 8 Startup and parameterization

### Configuring the digital input DI1 to freeze the counters

Hold Tot. mode enables maintenance work to be performed without interrupting the process.

When the device is in Hold Tot. mode:

- The counters do not increment any more (frozen).
- The device status LED flashes.
- The display appears along with the 4 to 20 mA current output, the status of each transistor output and the relay, and the measured value of the flow rate.
- The device is in Hold Tot. mode until the digital input switches again.

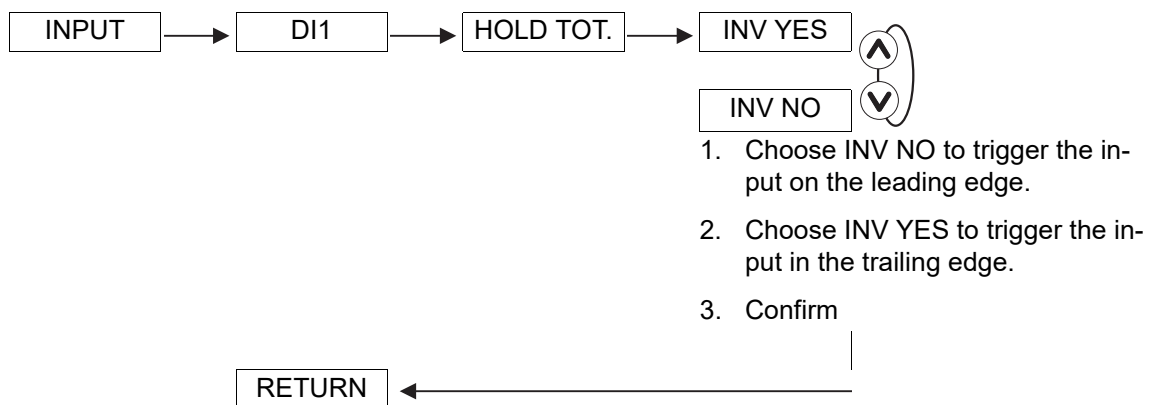

## 8 Startup and parameterization

---

### Configuring the digital input DI1 to reset the daily counter



**NOTE!**

The daily counter remains at zero until the digital input switches again.

---

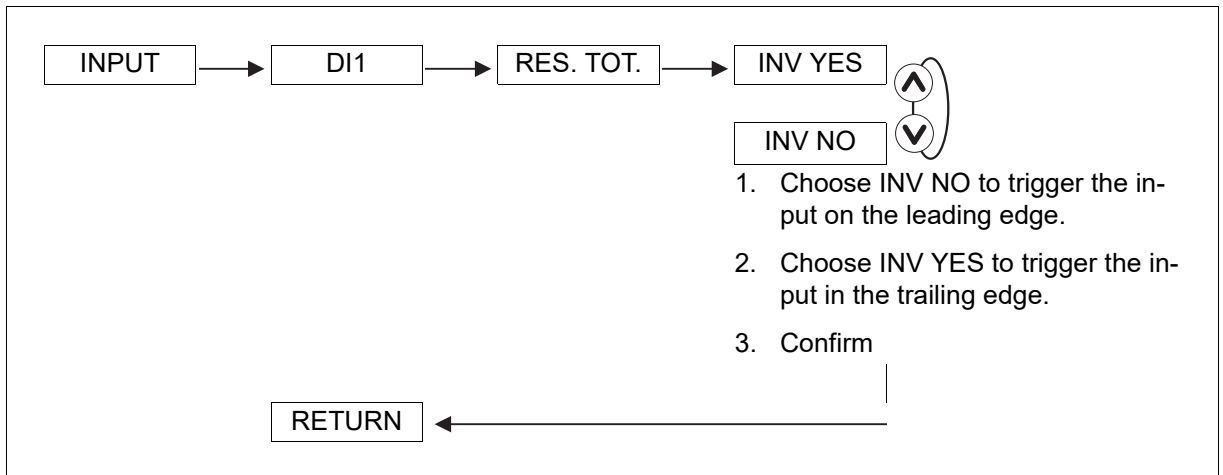

1. Choose INV NO to trigger the input on the leading edge.
2. Choose INV YES to trigger the input in the trailing edge.
3. Confirm

1. If you do not wish to change any further parameters, go to the END function in the parameters menu and press the  key in order to save the settings and return to the process level.

# 8 Startup and parameterization

## 8.6.13 Adjusting the filter to the measured flow rate

This function enables you to dampen the following fluctuations in the transmission of measured values:

- On the display
- At the current output AO1



**NOTE!**

If "fast" filtering has been selected and the flow rate changes by  $\pm 30\%$  (e.g., when switching the medium circulation on or off), the filter is deactivated: The new flow rate is emitted in non-filtered form.



**NOTE!**

If the filter selected is too high, the device does not recognize jumps in the flow rate. This can lead to large differences between the flow rate in the pipeline and the displayed flow rate or the value emitted at the current output.

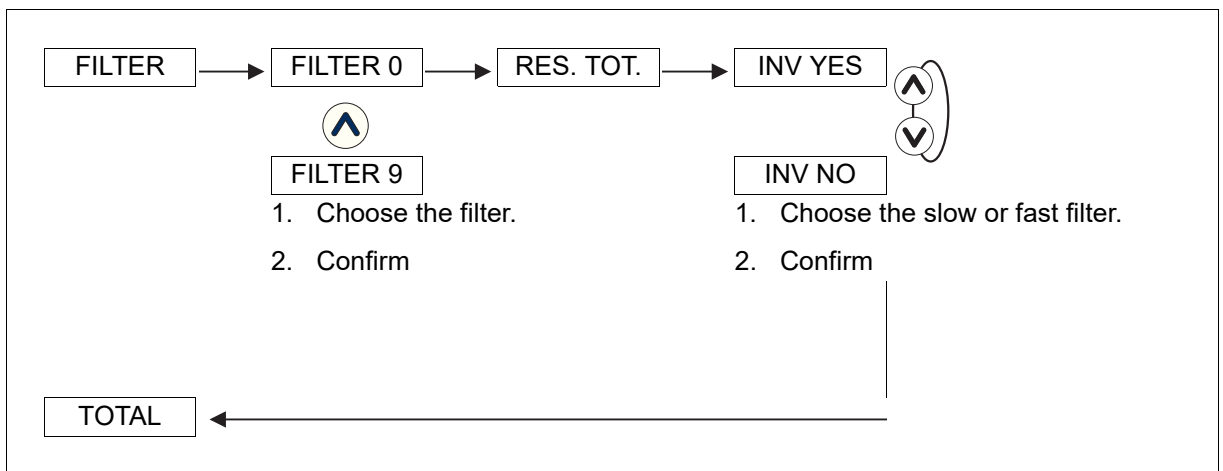

There are ten filters available. The following table lists the response times (10 to 90 %) for each filter:

Filter	Response time
0	1 s
1	2 s
2	3 s
3	4 s
4	5 s

Filter	Response time
5	8 s
6	15 s
7	28 s
8	70 s
9	145 s

# 8 Startup and parameterization

## Available filters

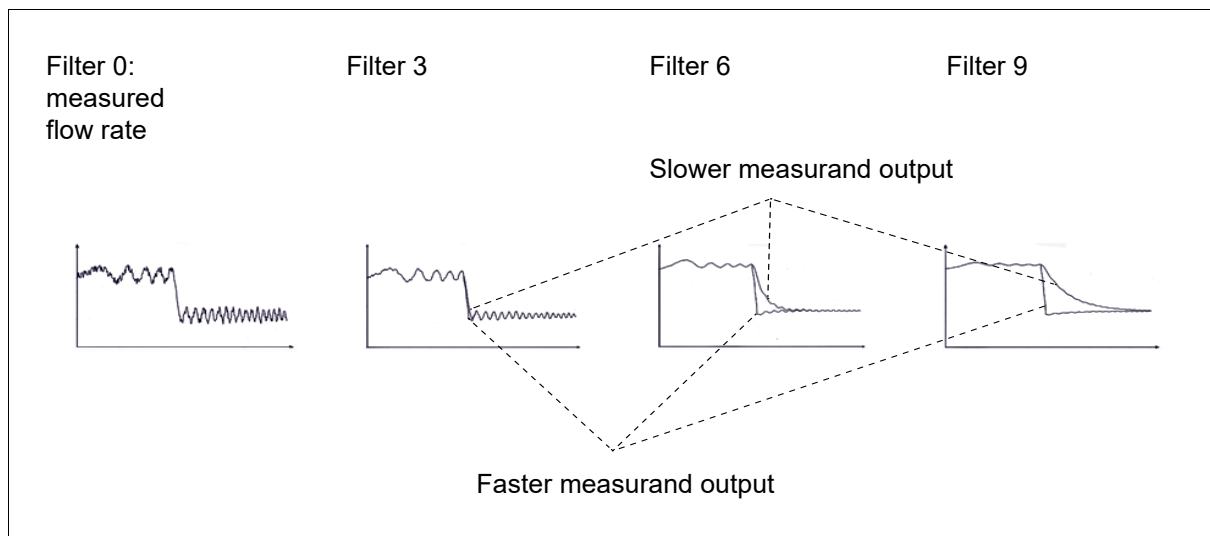

1. If you do not wish to change any further parameters, go to the END function in the parameters menu and press the  key in order to save the settings and return to the process level.

### 8.6.14 Resetting both counters

This function enables both counters to be reset.



#### NOTE!

Both counters are only reset if SAVE YES is confirmed when leaving the parameters menu.



#### NOTE!

The daily counter can be reset in the process level (⇒ see chapter 8.4 "Using the navigation keys", page 35) or via the digital input (⇒ see chapter 8.6.12 "Configuring the digital input DI1", page 55).

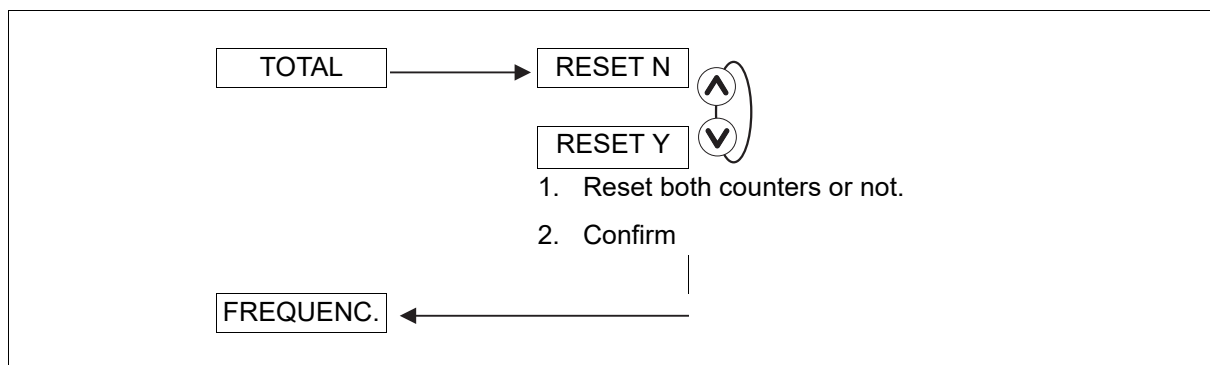

1. If you do not wish to change any further parameters, go to the END function in the parameters menu and press the  key in order to save the settings and return to the process level.

# 8 Startup and parameterization

## 8.6.15 Adjusting the mains frequency

This function enables the mains frequency to be adjusted so that the device can filter interfering signals in the supply voltage.



### NOTE!

Always adjust this parameter, even if the device is supplied with direct current (DC).

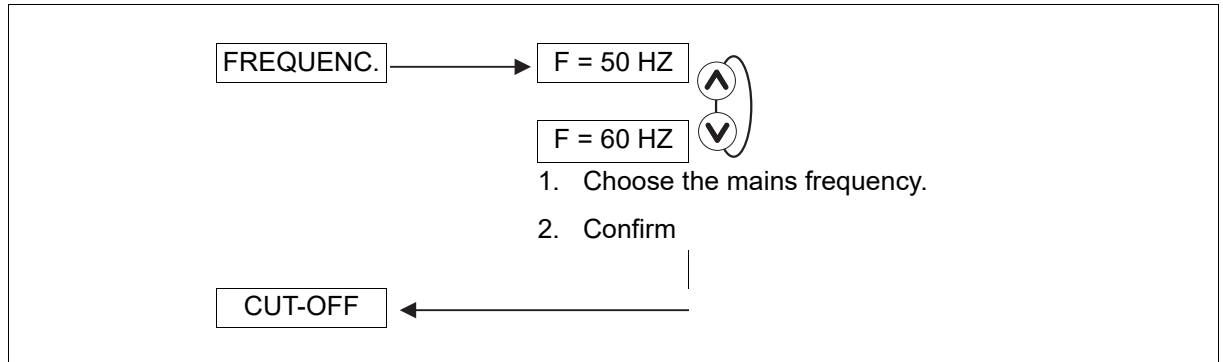

1. Choose the mains frequency.
2. Confirm

1. If you do not wish to change any further parameters, go to the END function in the parameters menu and press the  key in order to save the settings and return to the process level.

## 8.6.16 Adjusting the CUT-OFF flow rate

This function is used to adjust the flow rate value below which the device emits the flow rate as zero.

- The display shows a flow rate of zero; the flow rate unit is marked with a dot after it in the display
- Outputs and counters respond to the zero flow rate



### NOTE!

The units of the displayed values and the values to be entered manually correspond to the values selected in chapter 8.6.2 "Choosing the flow rate unit, the number of decimals, and the counter display unit", page 38.

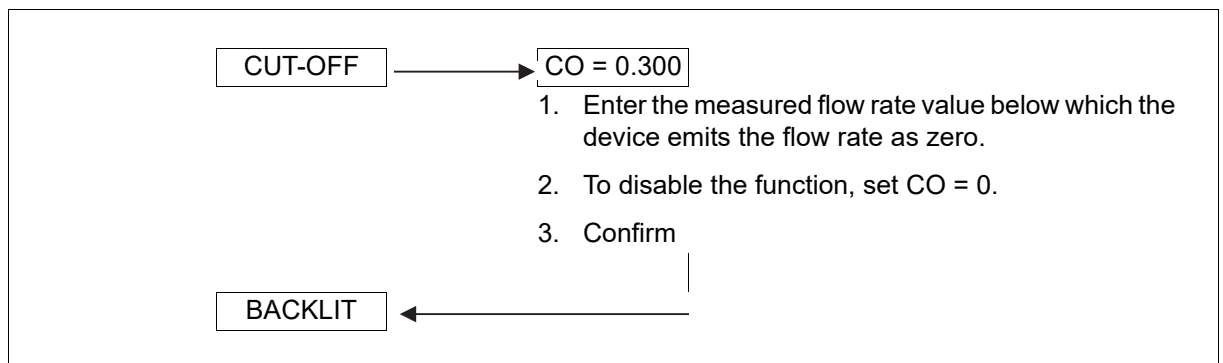

1. If you do not wish to change any further parameters, go to the END function in the parameters menu and press the  key in order to save the settings and return to the process level.

## 8 Startup and parameterization

### 8.6.17 Setting display backlight and how long it stays on, or deactivating the backlight

This function allows

- The brightness of the backlight to be activated and adjusted and an activation period to be selected after pressing a button;
- The backlight be deactivated.

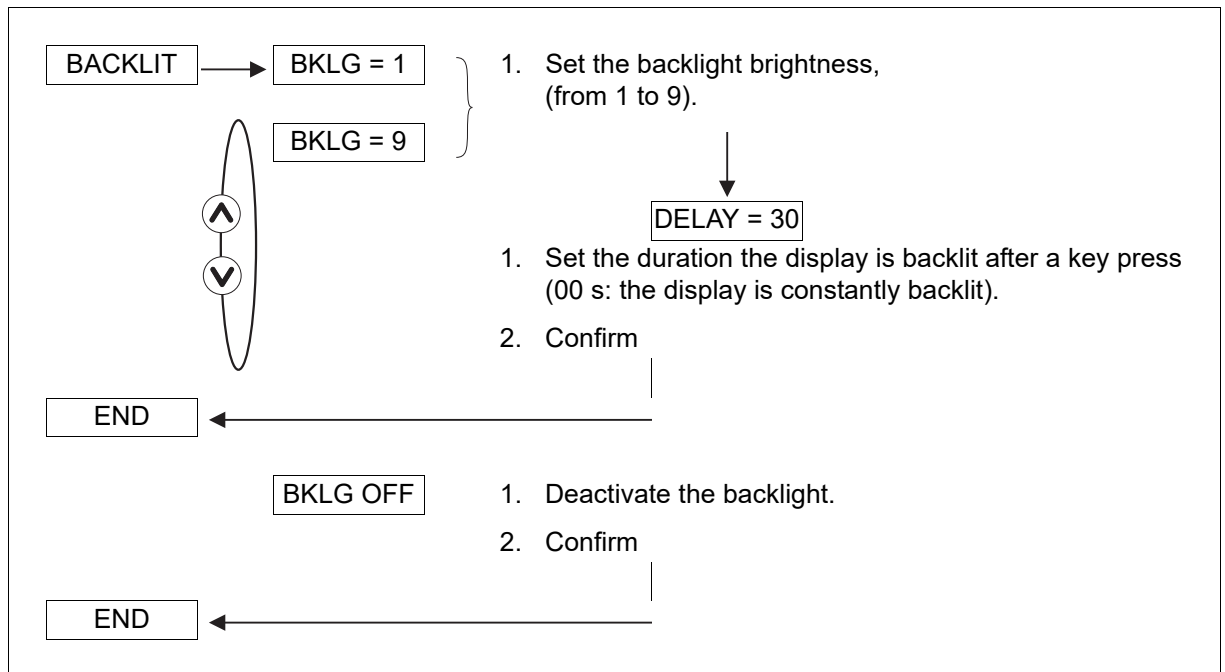

1. If you do not wish to change any further parameters, go to the END function in the parameters menu and press the  key in order to save the settings and return to the process level.



# 8 Startup and parameterization

## 8.7 Test menu details

To access the test menu, press the  +  +  keys at the same time for more than 5 seconds.

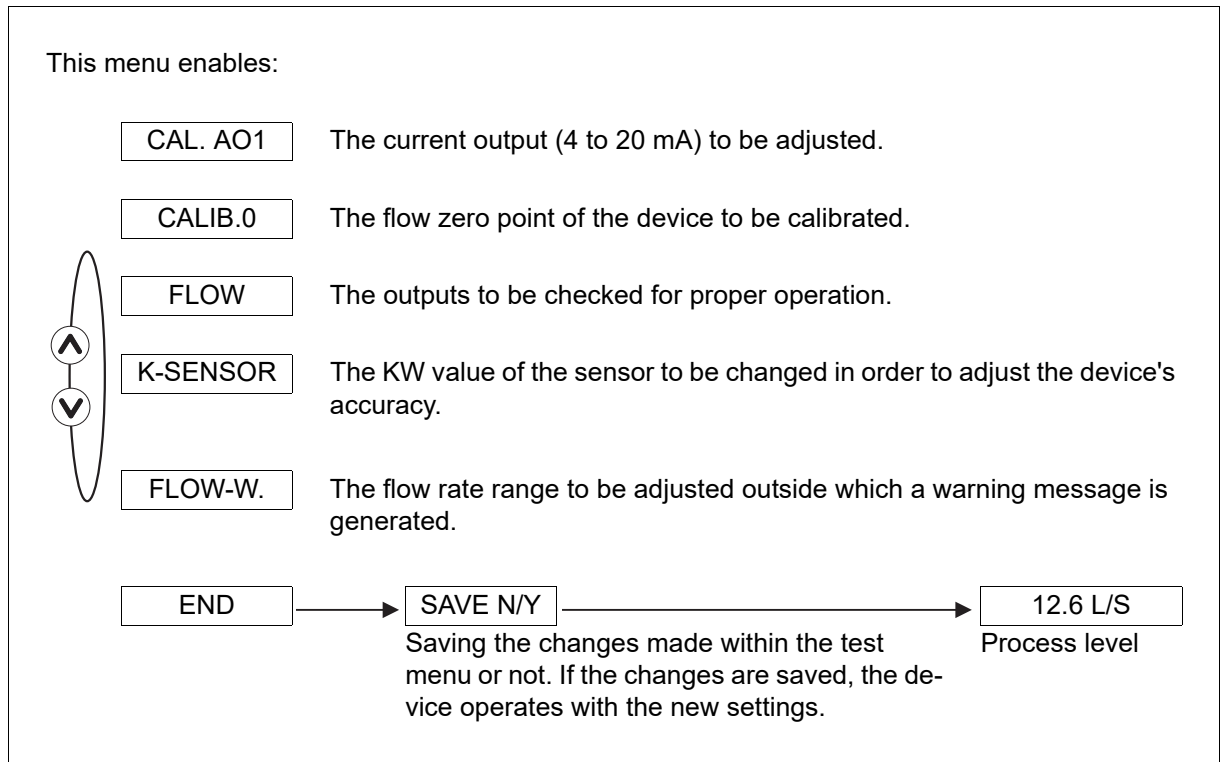

## 8 Startup and parameterization

### 8.7.1 Adjusting the current output AO1

This function allows for the adjustment of the signal values emitted at the analog output.

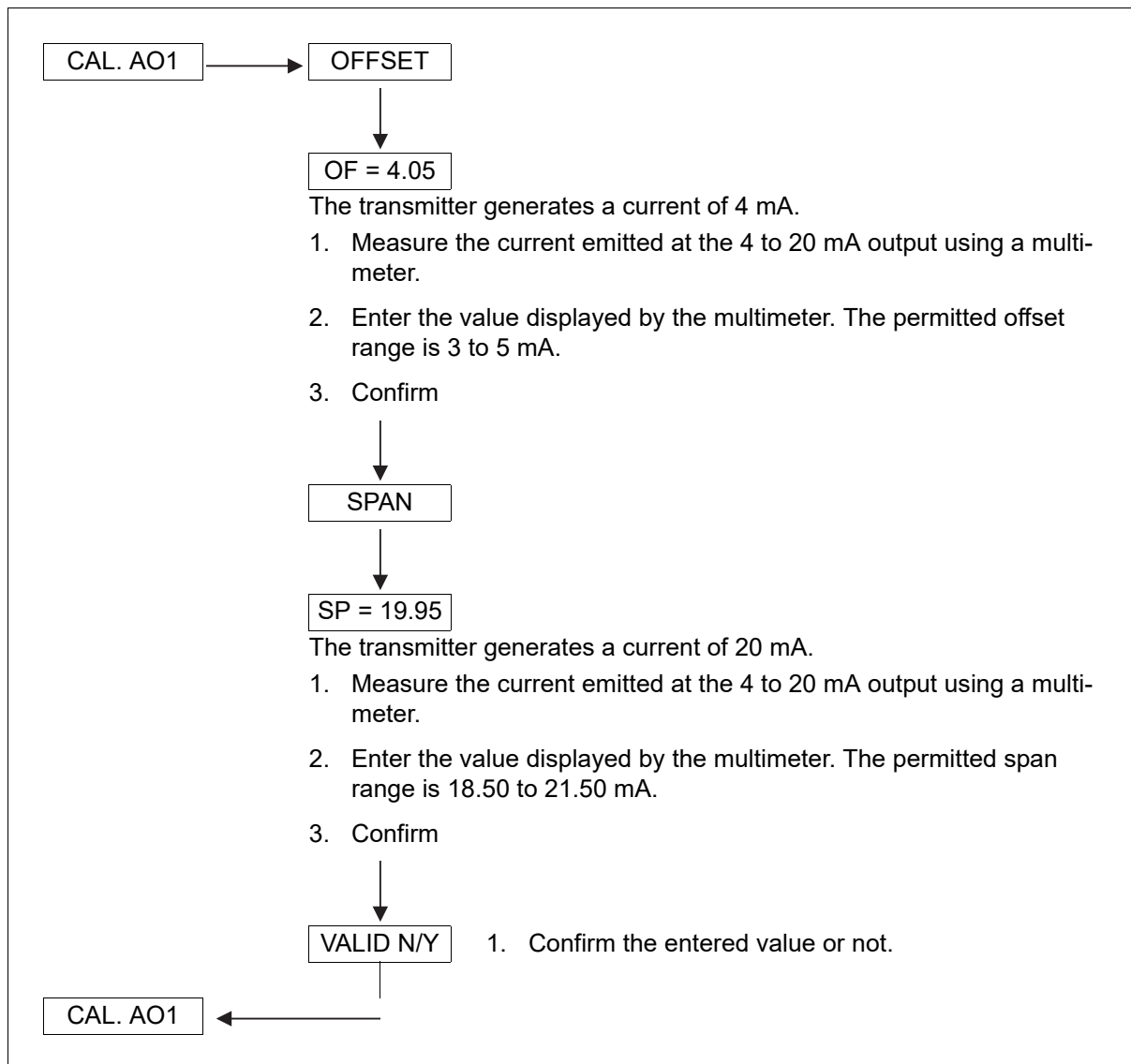

1. If you do not wish to change any further parameters, go to the END function in the test menu and press the  key in order to save the settings and return to the process level.

### 8.7.2 Calibrate the flow rate zero point



**NOTE!**

Adjust these parameters in the following cases:

- Before using the Teach-In for the K-factor
  - After performing maintenance work
  - If the measured flow rate is not zero, even though medium circulation has been stopped
- 



**NOTE!**

Make sure there are no air bubbles in the pipeline.

---



**NOTE!**

Before calibrating the flow rate zero point

- and before starting up the sensor for the first time, immerse it into the measuring material for 24 hours
  - and after performing maintenance work, immerse the sensor into the measuring medium for one hour
- 



**NOTE!**

During calibration

- The device status LED flashes
  - The outputs are frozen at the last measured flow rate
  - The device cannot be adjusted
-

## 8 Startup and parameterization

---

### Calibrating the flow rate zero point via the digital input



#### NOTE!

⇒ see also chapter 8.6.12 "Configuring the digital input DI1", page 55

---

1. Charge the pipe.
2. Stop medium circulation.
3. Make sure the device status LED is green.
4. Make sure the device is in the process level and not in the configuration level.
5. Activate the digital input configured to trigger the flow zero point calibration.

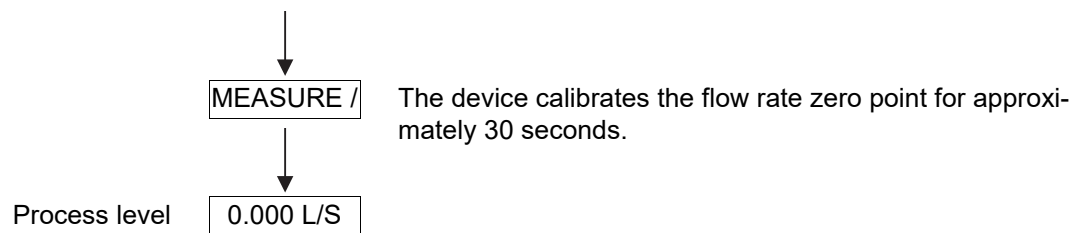



If the device status LED remains green, the calibration of the flow rate zero point has succeeded.

If the device status LED is orange, the calibration of the flow rate zero point failed: the message CAL.FAIL is displayed in the warning message list. Restart the calibration.

## 8 Startup and parameterization

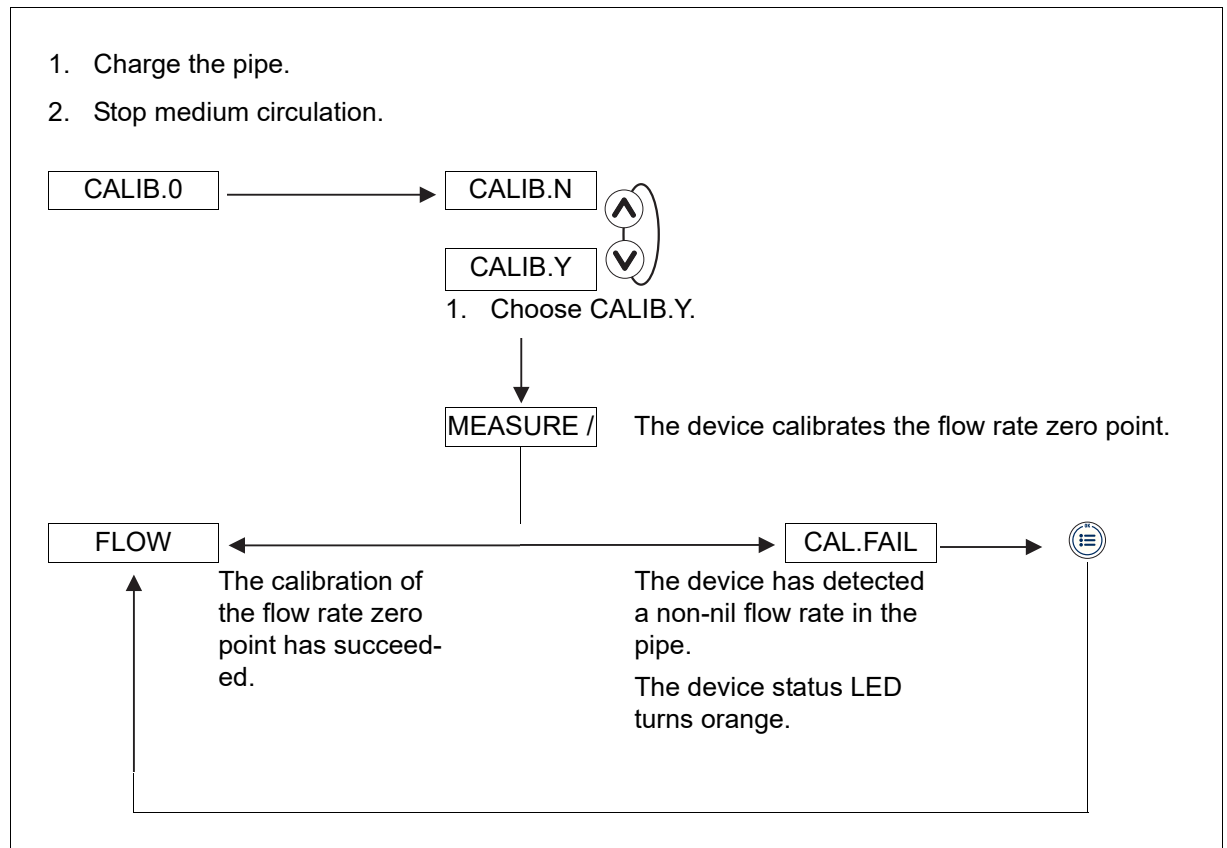
### Calibrating the flow rate zero point using the CALIB 0 function in the test menu



1. If you do not wish to change any further parameters, go to the END function in the test menu and press the  key in order to save the settings and return to the process level.

# 8 Startup and parameterization

## 8.7.3 Checking proper response of the outputs

This function can be used to test whether the outputs are responding according to the settings.



**NOTE!**

The counters are incremented according to the measured flow rate value and not according to the simulated value.

The device status LED flashes as long as the checking function for proper output response is active.

FLOW → SIM = 12.50

1. Enter a flow rate value in the selected unit.
2. Confirm by pressing the key.
3. Check that the outputs are responding as expected.
4. To test another value, press .
5. To exit simulation, press or .

1. If you do not wish to change any further parameters, go to the END function in the test menu and press the key in order to save the settings and return to the process level.

## 8.7.4 Changing the sensor's KW value

This parameter allows the device's precision to be adjusted.



**NOTE!**

Changing the sensor's KW value can affect the determination of the K-factor for the fitting (406090) with a calibration procedure, ⇒ see chapter 8.6.4 "Determining the fitting's K-factor with a calibration procedure (Teach-In)", page 41.

K-SENSOR → KW = 1.000

1. Enter the sensor's KW value (value between 0.850 and 1.150).
2. Confirm

FLOW-W. ←

Setting example: to increase the measured flow rate value by 1.5 %, enter KW = 1.015.

1. If you do not wish to change any further parameters, go to the END function in the test menu and press the key in order to save the settings and return to the process level.

# 8 Startup and parameterization

## 8.7.5 Monitoring the flow rate in the pipeline

A problem in the process or with the sensor can be detected if the flow rate measurement is too low or too high.

This function enables the medium flow rate to be monitored and a report to be triggered if the flow rate is too low or too high.



### NOTE!

Deactivating flow rate measurement monitoring: Set  $W^- = W^+ = 0$ .



### NOTE!

The units of the displayed values and the values to be entered manually correspond to the values selected in chapter 8.6.2 "Choosing the flow rate unit, the number of decimals, and the counter display unit", page 38.

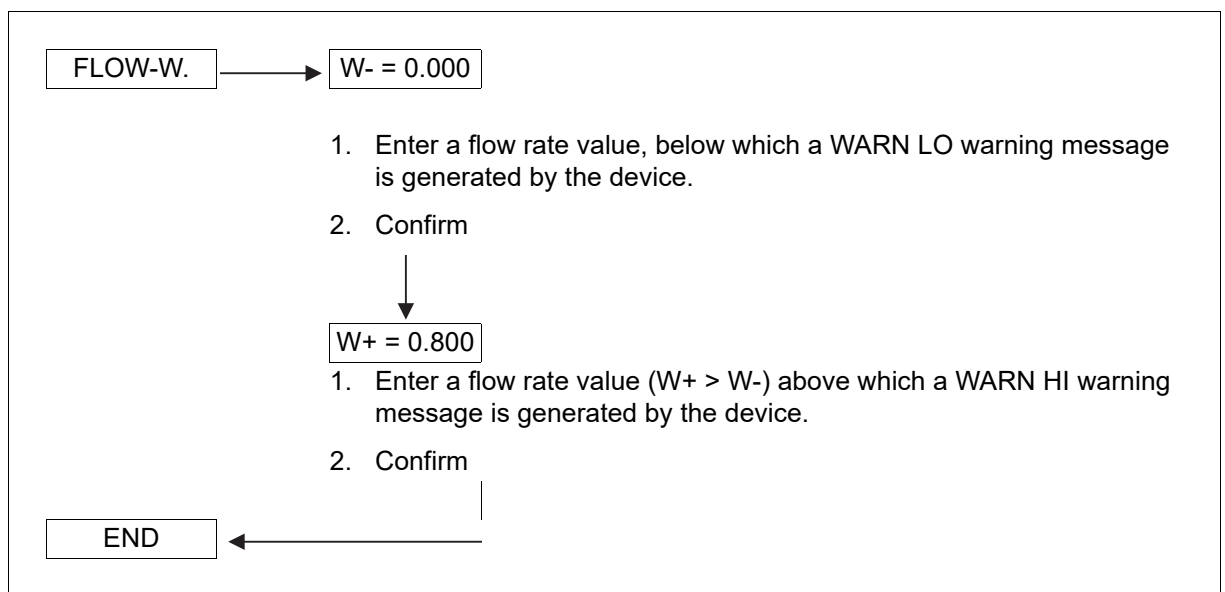

To trigger a report if the flow rate is too low or too high, set a flow rate range outside of which the device generates a WARN LO or WARN HI warning and switches on the orange device status LED.

If a WARN LO or WARN HI warning is generated

1. check the process.
2. If the process is not the cause, check the condition of the sensor and clean it if necessary.
3. If the flow rate measurement still is not correct, contact the manufacturer.



### NOTE!

The transistor or relay output can be configured to switch a load when the device generates a warning (⇒ see chapter 8.6.5 "Configuring outputs", page 44 and chapter 9.5 "Troubleshooting", page 76).

1. If you do not wish to change any further parameters, go to the END function in the test menu and press the key in order to save the settings and return to the process level.

# 8 Startup and parameterization

## 8.8 Information menu details



### NOTE!

This menu is only accessible when the device status LED is orange or red.

Meaning of a message ⇒ see chapter 9.5.4 "Solving a problem with a warning or error message with the red device status LED", page 79 and chapter 9.5.5 "Solving a problem with a warning or error message with the orange device status LED", page 80.

To access the information menu, press the  key for longer than 2 seconds in the process level.

This menu can be used to read off warnings and error messages generated by the device.

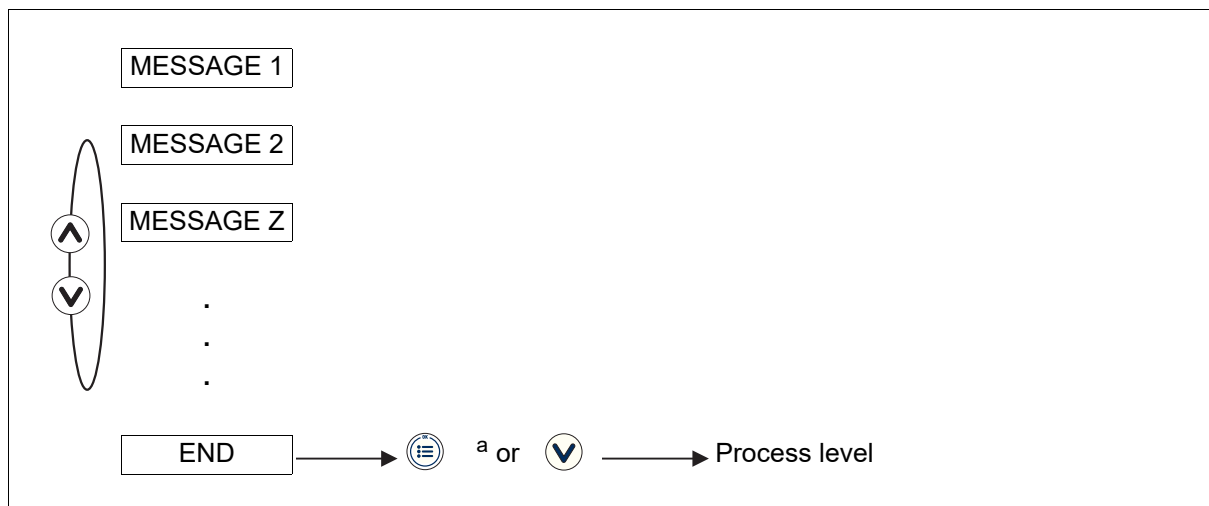

<sup>a</sup> When the CONFIRM key is unlocked



## 9.1 Safety information



### **Risk of injury resulting from high pressure levels within the system!**

Before working on the system, switch off the pressure and bleed/empty the lines.

---



### **Risk of electric shocks!**

Before working on the system or device, switch off the voltage and secure it so that it cannot switch on again.

Always observe the relevant accident prevention regulations and safety requirements for electrical devices.

---



### **Risk of injury due to high fluid temperatures!**

Always use safety gloves to touch the device.

Stop medium circulation and empty the pipelines before disconnecting the process connections.

---



### **Risk of injury resulting from the type of medium!**

When using dangerous media, always observe the specifications on the safety sheet and the relevant accident prevention regulations.

---



### **Risk of injury due to improper maintenance!**

Maintenance work must always be carried out by authorized and qualified personnel using suitable tools.

After conducting any work on the device, always make sure that the restart process is supervised.

---



### **NOTE!**

Startup after maintenance

After performing maintenance work, immerse the device in the measuring medium for one hour.

---

## 9 Maintenance

---

### 9.2 Returning devices



**NOTE!**

All documents important for the return as well as the return address of the manufacturer are available at <http://reparaturdienst.jumo.info>.

---



**NOTE!**

According to the EU Directive for hazardous materials, the owner of hazardous waste is responsible for its disposal or must observe the following regulations when shipping:

All devices delivered to the manufacturer must be free of any hazardous materials (acids, alkalis, solvents, etc.).

---

**The following applies for returning devices for repairs or recalibration:**

- Use the original packaging or suitably secure shipping containers.
- Enclose the completed accompanying repair form with the device.

**The following also applies to devices that have come into contact with hazardous materials:**

- Enclose the completed accompanying repair form and the declaration of decontamination with the device.

### 9.3 Cleaning the device and sensor



**NOTE!**

Before cleaning the device/sensor, always observe the basic safety notes! ⇒ See chapter 3 "Basic safety information", page 9

---



**NOTE!**

Always use a cleaning agent that is compatible with the materials used to make the device and sensor. ⇒ See also chapter 6.3.1 "Materials", page 15

---



**NOTE!**

After cleaning the sensor

- Rinse the sensor,
  - Check the seals and replace if necessary.
  - Calibrate the flow rate zero point before startup (⇒ see chapter 8.7.2 "Calibrate the flow rate zero point", page 67).
- 

Clean the device/sensor with a cloth slightly dampened with water or an agent that is compatible with the materials used to make the device.

To avoid any measurement errors caused by contamination of the measuring electrodes, clean the components that come into contact with the medium (define the cleaning frequency according to the process).

### 9.4 Replace the seal (device with G 2" union nut)



**NOTE!**

Do not scratch the seal's groove.

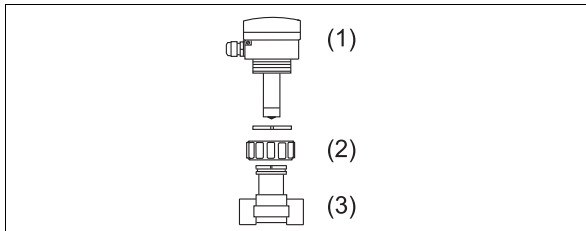

- (1) Device
- (2) Union nut
- (3) Fitting (type 406090)

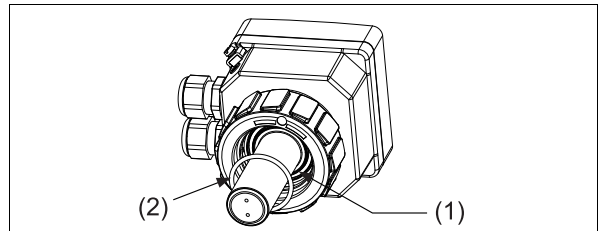

- (1) Groove
- (2) Seal

1. Unscrew the device's union nut.
2. Pull the device out of the fitting.
3. Remove the seal out of the groove.
4. Clean the seal's groove.
5. Place the new O-ring seal into the groove (⇒ see chapter 10 "Spare parts and accessories", page 82).
6. Place the device into the fitting
7. Tighten the union nut onto the device by hand.

## 9 Maintenance

### 9.5 Troubleshooting

#### 9.5.1 Solving a problem with the device status LED

Device status LED	Analog output AO1	Digital outputs DO1/DO2/DO3	Displayed message	Meaning	Measure
Off	0 mA	Low signal status	PWRFAIL	The voltage supply is too low. The device is not working.	<ul style="list-style-type: none"> <li>Make sure that the voltage supply is between DC 18 and 36 V.</li> <li>If the problem arises again, contact the manufacturer</li> </ul>
Off	0 mA	Not switched	-	The device is not supplied with power.	<ul style="list-style-type: none"> <li>Check connection</li> <li>Check the installation's fuse and replace if necessary</li> <li>Check that the system's switch-off device is deactivated</li> <li>Check that the voltage supply is working correctly</li> </ul>

#### 9.5.2 Solving a problem without a warning or error message with the device status LED

Device status LED	Analog output AO1	Digital outputs DO1/DO2/DO3	Problem	Measure
Regardless of the color	4 to 20 mA	Depending on switching thresholds or switched <sup>a</sup>	Unable to access the parameters menus and test menu	<ul style="list-style-type: none"> <li>Check the position of the selection switch to lock or unlock the CONFIRM key, ⇒ see "Use of the selection switch to lock or unlock the CONFIRM key", page 27</li> </ul>
Regardless of the color	0 mA	Depending on the switching thresholds or switched <sup>a</sup>	The current output emits a 0 mA current.	<ul style="list-style-type: none"> <li>Check the current output's connection</li> <li>Check the installation's fuse and replace if necessary</li> <li>Check the position of the sink/source selection switch, ⇒ see chapter 7.3.5 "Connection for the current output AO1", page 29</li> <li>If the problem arises again, contact the manufacturer.</li> </ul>
Regardless of the color	4 mA	Depending on the switching thresholds or switched <sup>a</sup>	The current output emits a signal between 0 and 4 mA.	<ul style="list-style-type: none"> <li>Switch the device's power supply off and on.</li> <li>If the problem arises again, contact the manufacturer.</li> </ul>
Regardless of the color	4 mA	Depending on the switching thresholds or switched <sup>a</sup>	The current output emits a 4 mA signal, regardless of the flow rate displayed.	<ul style="list-style-type: none"> <li>Check the settings for the current output, ⇒ see chapter 8.6.6 "Configuring current output AO1", page 45</li> </ul>

## 9 Maintenance

Device status LED	Analog output AO1	Digital outputs DO1/DO2/DO3	Problem	Measure
Regardless of the color	20 mA	Depending on the switching thresholds or switched <sup>a</sup>	The current output emits a 20 mA signal, regardless of the flow rate displayed.	<ul style="list-style-type: none"> <li>Check the settings for the current output, ⇒ see chapter 8.6.6 "Configuring current output AO1", page 45</li> </ul>
Regardless of the color	22 to 30 mA	Depending on the switching thresholds or switched <sup>a</sup>	The current output emits a signal between 22 and 30 mA.	<ul style="list-style-type: none"> <li>Switch the device's power supply off and on.</li> <li>If the problem arises again, contact the manufacturer.</li> </ul>
Regardless of the color	30 mA	Depending on the switching thresholds or switched <sup>a</sup>	The current output emits a signal > 30 mA.	<ul style="list-style-type: none"> <li>Check the current output's connection.</li> <li>If the problem arises again, contact the manufacturer.</li> </ul>
Regardless of the color	4 to 20 mA	Depending on the switching thresholds or switched <sup>a</sup>	The signal value emitted by the current output does not match the flow rate measured.	<ul style="list-style-type: none"> <li>Check the settings for the current output, ⇒ see chapter 8.6.6 "Configuring current output AO1", page 45</li> <li>Check the OFFSET and SPAN settings for the current output, ⇒ see chapter 8.7.1 "Adjusting the current output AO1", page 66</li> </ul>
Regardless of the color	4 to 20 mA	The relay outputs DO2 and DO3 do not switch, regardless of the flow rate displayed.		<ul style="list-style-type: none"> <li>Check the settings for the relay outputs DO2 and DO3, ⇒ see chapter 8.6.11 "Configuring the relay outputs DO2 and DO3", page 52</li> <li>Check the flow rate unit</li> <li>Check the outputs' response, ⇒ see chapter 8.7.3 "Checking proper response of the outputs", page 70</li> </ul>

<sup>a</sup> If the output has been configured to switch upon generation of a warning, ⇒ see chapter 8.6.5 "Configuring outputs", page 44

## 9 Maintenance

### 9.5.3 Solving a problem without a warning or error message with a green device status LED

Device status LED	Analog output AO1	Digital outputs DO1/DO2/DO3	Meaning	Measure
Green	4 to 20 mA	Depending on switching thresholds or switched <sup>a</sup>	The device is not measuring the flow rate correctly.	<ul style="list-style-type: none"> <li>Check that the K-factor matches the fitting used</li> <li>Check that the KW value has not been switched</li> <li>Perform a Teach-In process to determine the K-factor for the fitting used</li> </ul>
Green	4 to 20 mA	Depending on the switching thresholds or switched <sup>a</sup>	The displayed flow rate is not zero even though the flow rate in the pipeline is zero.	<ul style="list-style-type: none"> <li>Check that the flow rate in the pipeline is zero-</li> <li>Check that there are no air bubbles in the pipeline-</li> <li>Check the filter level-</li> <li>Calibrate the flow rate zero point.</li> </ul>
Green	4 to 20 mA	Depending on the switching thresholds or switched <sup>a</sup>	The displayed flow rate is always zero.	<ul style="list-style-type: none"> <li>Check that the flow rate in the pipeline is not zero.</li> <li>Check that the K factor or KW value are not too low.</li> <li>Check that the measuring electrodes are mounted so that they are perpendicular to the direction of flow.</li> <li>Select a smaller flow rate unit or increased the number of decimal places displayed.</li> </ul>
Green	4 to 20 mA	Depending on the switching thresholds or switched <sup>a</sup>	The displayed flow rate is not stable.	<ul style="list-style-type: none"> <li>Check whether the medium is flowing in the pipeline</li> <li>Select a higher filter</li> </ul>
Green	4 to 20 mA	Depending on the switching thresholds or switched <sup>a</sup>	The flow rate display is changing at a very slow pace.	<ul style="list-style-type: none"> <li>Check whether the medium is flowing in the pipeline</li> <li>Select a smaller filter</li> </ul>

<sup>a</sup> If the output has been configured to switch upon generation of a warning, ⇒ see chapter 8.6.5 "Configuring outputs", page 44

### 9.5.4 Solving a problem with a warning or error message with the red device status LED

Device status LED	Analog output AO1	Digital outputs DO1/DO2/DO3	Displayed message	Meaning	Measure
Red	22 mA	Depending on the thresholds	"ERROR3"	<p>The user settings and factory calibration have been lost.</p> <p>The device is measuring the wrong values.</p>	<ul style="list-style-type: none"> <li>Restart the device</li> <li>If the problem arises again, contact the manufacturer</li> <li>If the message LIN.LOST is generated at the same time, contact the manufacturer.</li> </ul>
Red	22 mA	Depending on the thresholds	ERROR4	<p>The counter values have been lost.</p> <p>The values saved from the previous exterior voltage mains supply are used.</p>	<ul style="list-style-type: none"> <li>Restart the device</li> <li>If the problem arises again, contact the manufacturer.</li> </ul>
Red	22 mA	Depending on the thresholds	ERROR5	Both ERROR3 and ERROR4	<ul style="list-style-type: none"> <li>Contact the manufacturer</li> </ul>
Red	22 mA	Depending on the thresholds	ERROR6	<p>Counter values have been lost completely</p> <p>Both counters are reset.</p>	<ul style="list-style-type: none"> <li>Restart the device</li> <li>If the problem arises again, contact the manufacturer</li> </ul>
Red	22 mA	Depending on the thresholds	ERROR7	Both ERROR3 and ERROR6	<ul style="list-style-type: none"> <li>Contact the manufacturer</li> </ul>
Red	22 mA	Depending on the thresholds	MEAS.OVF	Flow rate in the pipeline is > 12 m/s.	<ul style="list-style-type: none"> <li>Check the flow rate in the pipeline</li> <li>Reduce the flow rate if necessary</li> <li>If the problem arises again, contact the manufacturer</li> </ul>
Red	22 mA	Depending on the thresholds	BAD MEAS.	<p>Faulty measuring signal</p> <p>The flow rate is not measured correctly.</p>	<ul style="list-style-type: none"> <li>Make sure that the medium is in the pipeline</li> <li>Make sure there are no air bubbles in the medium</li> <li>Check the potential equalization of the installation</li> <li>If the problem arises again, contact the manufacturer</li> </ul>

## 9 Maintenance

### 9.5.5 Solving a problem with a warning or error message with the orange device status LED

Device status LED	Analog output AO1	Digital outputs DO1/DO2/DO3	Displayed message	Meaning	Measure
Orange	4 to 20 mA	Switched <sup>a</sup>	PULS.OVF	The value set for the pulse output is incorrect (the frequency generated is > 250 Hz).	<ul style="list-style-type: none"> <li>Select a higher value for the parameter PU, see ⇒ see chapter 8.6.7 "Configuring the transistor output DO1 as a pulse output", page 46</li> </ul>
Orange	4 to 20 mA	Switched <sup>a</sup>	NEG. FLOW	The measured flow rate is negative (even though the value on the display is positive).	<ul style="list-style-type: none"> <li>Make sure that reversing the direction of flow does not have a negative impact on the process</li> <li>If it does, mount the device on the pipeline so that the arrow on the side of the housing is pointing in the direction of flow</li> </ul>
Orange	4 to 20 mA	Switched <sup>a</sup>	WARN. LOW	<p>The measured flow rate is below the selected minimum flow rate.</p> <p>This message is only generated when flow rate monitoring is active (⇒ see chapter 8.7.5 "Monitoring the flow rate in the pipeline", page 71).</p>	<ul style="list-style-type: none"> <li>Check the flow rate in the pipeline and any potential consequences</li> <li>If necessary, clean the sensor and calibrate the flow rate zero point</li> </ul>
Orange	4 to 20 mA	Switched <sup>a</sup>	WARN.HIG	<p>The measured flow rate is above the selected maximum flow rate.</p> <p>This message is only generated when flow rate monitoring is active (⇒ see chapter 8.7.5 "Monitoring the flow rate in the pipeline", page 71).</p>	<ul style="list-style-type: none"> <li>Check the flow rate in the pipeline and any potential consequences</li> <li>If necessary, clean the sensor and calibrate the flow rate zero point</li> </ul>



## 9 Maintenance

Device status LED	Analog output AO1	Digital outputs DO1/DO2/DO3	Displayed message	Meaning	Measure
Orange	4 to 20 mA	Switched <sup>a</sup>	DISP.OVF	The measured flow rate display in the process level is full and does not correspond to the actual flow rate.	<ul style="list-style-type: none"> <li>Change the unit or decimal places in the UNIT function in the parameters menu so that the display can show higher values</li> </ul>
				Apart from the display, the device is working in line with the actual value for the flow rate.	
Orange	4 to 20 mA	Switched <sup>a</sup>	LIN.LOST	The factory calibration has been lost.	<ul style="list-style-type: none"> <li>Contact manufacturer</li> </ul>
				The device is measuring the wrong values.	
Orange	4 to 20 mA	Switched <sup>a</sup>	CAL.FAIL	Calibration of the flow rate zero point failed.	<ul style="list-style-type: none"> <li>Refer to the conditions for calibration, ⇨ see chapter 8.7.2 "Calibrate the flow rate zero point", page 67</li> </ul>

<sup>a</sup> If the output has been configured to switch upon generation of a warning, ⇨ see chapter 8.6.5 "Configuring outputs", page 44

# 10 Spare parts and accessories



**Risk of injury or material damage due to unsuitable parts!**

Using the wrong accessories and unsuitable spare parts can cause injuries and damage to the device and its environment.

Always use genuine accessories and genuine spare parts supplied by the manufacturer.

Designation	Part no.
PC lid, with flap, window, screws and adhesive film	693539
PPA lid, with flap, window, screws and adhesive film	693548
Set with 2 cable fittings M20 × 1.5 2 flat seals made from CR for cable fittings or screw plugs 2 screw plugs M20 × 1.5 2 multiway seals 2 × 6 mm	693568
Set with 2 reductions M20 × 1.5/NPT 1/2" (with mounted seal) 2 flat seals made from CR for screw plugs 2 screw plugs M20 × 1.5	693590
Set with 1 plug for cable fitting M20 × 1.5 1 multiway seal 2 × 6 mm, for cable fitting 1 green seal made from FKM 1 installation instruction	693607
Set with 1 green seal made from FKM 1 black seal made from EPDM	693610
Set with 1 plug for cable fitting M20 × 1.5 1 multiway seal 2 × 6 mm, for cable fitting	693612
Circlip	693620
PC union nut for PC housing	693625
PPA union nut for PPA housing	693627



**NOTE!**

Transport damage!

Failing to protect the device properly can cause damage during transport.

Transport the device in an impact-proof packaging solution that is protected from moisture and contamination.

Do not subject the device to temperatures outside of the admissible storage temperature range, ⇨ see chapter 12 "Storage", page 84.

Seal any electrical interfaces with protective caps to protect them against damage.

---

## 12 Storage

---



**NOTE!**

Incorrect storage can cause damage to the device!  
Store the device in a dry and dust-free environment!  
Device storage temperature range: -20 to +60 °C.

---



**NOTE!**

Environmental damage caused by improper disposal

The country-specific laws and regulations for handling and disposing of waste must be observed!

---



**NOTE!**

At the end of its service life, the device and any batteries present do not belong in the trash!

---

# 14 China RoHS

						
产品组别 Product group: 406011	<b>产品中有害物质的名称及含量</b> <b>China EEP Hazardous Substances Information</b>					
部件名称 Component Name						
	铅 ( Pb )	汞 ( Hg )	镉 ( Cd )	六价铬 ( Cr(VI) )	多溴联苯 ( PBB )	多溴二苯醚 ( PBDE )
外壳 Housing (Gehäuse)	○	○	○	○	○	○
过程连接 Process connection (Prozessanschluss)	○	○	○	○	○	○
螺母 Nuts (Mutter)	○	○	○	○	○	○
螺栓 Screw (Schraube)	○	○	○	○	○	○
<p>本表格依据SJ/T 11364的规定编制。          This table is prepared in accordance with the provisions SJ/T 11364.          ○：表示该有害物质在该部件所有均质材料中的含量均在GB/T 26572规定的限量要求以下。          Indicate the hazardous substances in all homogeneous materials' for the part is below the limit of the GB/T 26572.</p> <p>×：表示该有害物质至少在该部件的某一均质材料中的含量超出GB/T 26572规定的限量要求。          Indicate the hazardous substances in at least one homogeneous materials' of the part is exceeded the limit of the GB/T 26572.</p>						





**JUMO GmbH & Co. KG**

Street address:  
Moritz-Juchheim-Straße 1  
36039 Fulda, Germany

Delivery address:  
Mackenrodtstraße 14  
36039 Fulda, Germany

Postal address:  
36035 Fulda, Germany

Phone: +49 661 6003-0  
Fax: +49 661 6003-607  
Email: [mail@jumo.net](mailto:mail@jumo.net)  
Internet: [www.jumo.net](http://www.jumo.net)

**JUMO Instrument Co. Ltd.**

JUMO House  
Temple Bank, Riverway  
Harlow, Essex, CM20 2DY, UK

Phone: +44 1279 63 55 33  
Fax: +44 1279 62 50 29  
Email: [sales@jumo.co.uk](mailto:sales@jumo.co.uk)  
Internet: [www.jumo.co.uk](http://www.jumo.co.uk)

**JUMO Process Control, Inc.**

6733 Myers Road  
East Syracuse, NY 13057, USA

Phone: +1 315 437 5866  
Fax: +1 315 437 5860  
Email: [info.us@jumo.net](mailto:info.us@jumo.net)  
Internet: [www.jumousa.com](http://www.jumousa.com)

